

A Timeline of the Mathematics Curricula Assessed by Regents Examinations in the Public Schools of New York State: 1866-2009

(as represented in this research sample)

Differentiated Curricula

 Integrated Curricula

Academic Examinations

Legend:

AAR
Advanced Arithmetic

BA
Business Arithmetic;

GE
Geometry

HA
Higher Algebra;

IA
Integrated Algebra

MP
Preliminary Mathematics

SMSG
Special Geometry (SMSG) Examination

ST
Spherical Trigonometry

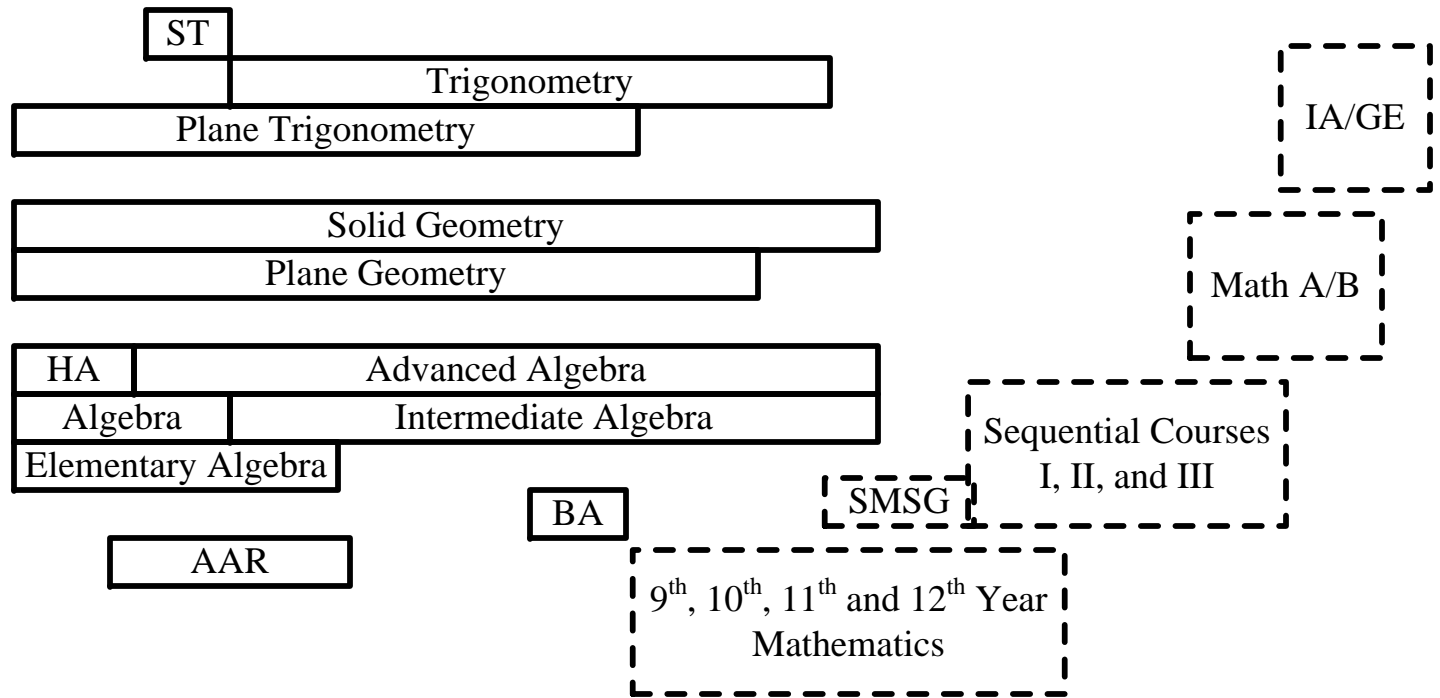

Preliminary Examinations

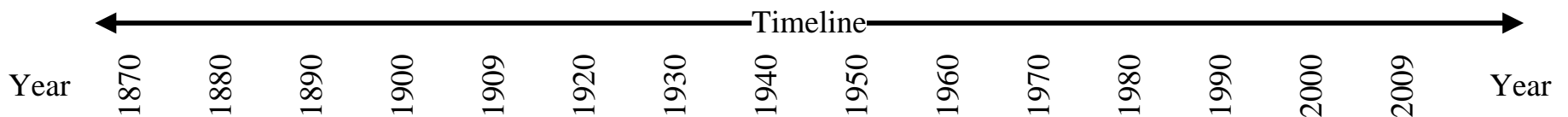

AA - The Advanced Algebra Curriculum (1890 - 1940)

- 1 1890_06_AA_01 Radicals: Operations with
Find the sum of $\sqrt{\frac{a^2(a-b)}{a+b}}$, $\sqrt{\frac{b^2(a+b)}{a-b}}$ and $(a^2 - 3b^2)\sqrt{\frac{1}{a^2 - b^2}}$.
- 2 1890_06_AA_02 Fractions: Complex
Simplify $\left(\frac{x^{p+q}}{x^q}\right)^p \div \left(\frac{x^q}{x^{q-p}}\right)^{p-q}$
- 3 1890_06_AA_03 Rationals: Solving
Solve $\frac{\sqrt{4x} + 2}{4 + \sqrt{x}} = \frac{4 - \sqrt{x}}{\sqrt{x}}$
- 4 1890_06_AA_04 Systems: Other Nonlinear
Solve $(x+y)^2 - 4(x+y) = 45$
 $(x-y)^2 - 2(x-y) = 3$
- 5 1890_06_AA_05 Rate, Time and Distance
A railway passenger observes that a train passes him moving in the opposite direction in 2 seconds; whereas if it had been moving in the same direction with him it would have passed him in 30 seconds. Compare the rates of the two trains.
- 6 1890_06_AA_06 Central Tendency: Averages
Find the arithmetical mean between $a^2 + ab - b^2$ and $a^2 - ab + b^2$.
- 7 1890_06_AA_07 Progressions: Arithmetic and Geometric
Three numbers whose sum is 18 are in arithmetical progression; if 1, 2, and 7 be added to them respectively they are in geometrical progression. Required the numbers.
- 8 1890_06_AA_08 Combinatorics: Combinations
At a certain house there were 8 regular boarders; and one of them agreed with the landlord to pay \$35 for his board so long as he could select from the company different parties, equal in number, to sit each for one day on a certain side of the table. At what price a day did he secure his board?
- 9 1890_06_AA_09 Binomial Expansions
Expand $\frac{1}{\sqrt[3]{1+x}}$ to five terms by the binomial theorem.
- 10 1890_06_AA_10 Logarithms
What system of logarithms is used in practical calculations? What two logarithms are constant in value whatever the system?
- 11 1890_06_AA_11 Fractions: Partial
Separate into partial fractions $\frac{2x^2 - 7x + 1}{x^3 + 1}$.
- 12 1890_06_AA_12 Binomial Expansions: Undetermined Coefficients
Expand to five terms by the method of indeterminate coefficients $\frac{2 - 3x + 4x^2}{1 + 2x - 5x^2}$.
- 13 1890_06_AA_13 Equations: Roots of Higher Order
Solve $x^4 + x^3 - 14x^2 - 2x + 24 = 0$
- 14 1900_01_AA_01 Radicals: Square Roots
Prove that a quadratic surd can not equal the sum of a rational quantity and a quadratic surd. Extract the square root of $20 - 5\sqrt{12}$.
- 15 1900_01_AA_02 Radicals: Simplifying
Simplify $\frac{\sqrt{-x} + \sqrt{-y}}{\sqrt{-x} - \sqrt{-y}}$, $\frac{a + \sqrt{-x^2}}{a - \sqrt{-x^2}}$, $\frac{a - \sqrt{-x^2}}{a + \sqrt{-x^2}}$

16 1900_01_AA_03 Radicals: N-Roots

Extract the cube root of

$$a^{\frac{1}{2}} - 9a^{\frac{3}{4}} + 33a^{\frac{5}{6}} - 63a + 66a^{\frac{7}{8}} - 36a^{\frac{3}{4}} + 8a^{\frac{5}{6}}$$

17 1900_01_AA_04 Radicals: Solving

Solve
$$\sqrt[4]{\frac{1}{x^4}} + \frac{1}{x^{\frac{1}{2}}} = \frac{3 - \sqrt[3]{x^2}}{x}$$

18 1900_01_AA_05 Radicals: Solving

Solve
$$\sqrt{x+3} + \sqrt[3]{x+3} = 6$$

19 1900_01_AA_06 Systems: Writing

A crew rows down stream and back, a total distance of 40 miles, in 7 hours; had the rate of rowing up stream been 2 miles an hour less, the return trip would have taken 10 hours. Find the rate of *a*) the crew in still water, *b*) the stream.

20 1900_01_AA_07 Proofs: Algebraic

Prove that if four quantities are in proportion they will be in proportion by *a*) composition, *b*) alternation.

21 1900_01_AA_08 Combinatorics: Combinations

In a school of 25 boys and 18 girls how many classes could be formed each to consist of 5 boys and 3 girls?

22 1900_01_AA_09 Progressions: Arithmetic and Geometric

Derive the formula for *a*) the last term of a geometric progression, *b*) the sum of the terms of an arithmetic progression.

23 1900_01_AA_10 Binomial Theorem

Find by the binomial theorem the value of $\sqrt[3]{34}$ to *four* decimal places.

24 1900_01_AA_11 Fractions: Partial

Resolve into partial fractions
$$\frac{2x^2 + x - 1}{2x^2 + x - 3}$$

25 1900_01_AA_12 Binomial Expansions: Undetermined Coefficients

Expand $\sqrt{1+x+x^2}$ to four terms by the method of undetermined coefficients.

26 1900_01_AA_13 Equations: Logarithmic

Given $\log 2 = .3010$, $\log 3 = .4771$, $\log 7 = .8451$, find

$$\log \frac{7^4 \sqrt{30}}{21^{\frac{1}{5}}}$$

Solve $15^x = 168$.

27 1900_01_AA_14 Series

Find the sum of the series

$$1 + 2x + 7x^2 + 23x^3 + 76x^4 + \dots$$

28 1900_01_AA_15 Equations: Literal

Transform $x^4 - 8x^3 - 5x + 1 = 0$ into an equation whose second term is wanting.

29 1900_06_AA_01 Radicals: Operations with

Simplify
$$\frac{x - 7x^{\frac{1}{2}}}{x - 5\sqrt{x} - 14} \div \left(1 + \frac{2}{\sqrt{x}} \right)^{-1}$$

30 1900_06_AA_02 Triangles: Mean Proportionals

Find a mean proportional between

$$2x^{3n} + 7x^{2n} + 4x^n - 4 \text{ and } 2x^n - 1.$$

31 1900_06_AA_03 Radicals: Rationalizing Denominators

Reduce $\frac{1}{\sqrt[3]{a} + \sqrt[3]{b}}$ to a fraction having a rational denominator.

32 1900_06_AA_04 Proofs: Algebraic

Prove that any factor may be transferred from the numerator of a fraction to the denominator by changing the sign of its exponent.

33 1900_06_AA_05 Proofs: Algebraic

State and prove the theorem of limits.

- 34 1900_06_AA_06 Combinatorics: Combinations
How many different committees, each consisting of 4 men and 3 women, can be selected from a company of 12 men and 9 women?
- 35 1900_06_AA_07 Progressions: Geometric
The sum of the first four terms of a geometric series is 130, and the sum of the first two terms is 40; find the 9th term of the series.
- 36 1900_06_AA_08_09 Quadratics: Using the Discriminant
Show under what conditions the two roots of the equation $ax^2 + bx + c$ will be: a) equal, b) positive, c) negative, d) imaginary. Give proofs.
- 37 1900_06_AA_10 Binomial Expansions: Undetermined Coefficients
Expand $\frac{1+x}{2+x+x^2}$ into a series of the ascending powers of x by the method of undetermined coefficients, finding *four* terms.
- 38 1900_06_AA_11 Continued Fractions
Using continued fractions find *three* approximate values of π (3.14159) in common fractions.
- 39 1900_06_AA_12 Binomial Expansions
Write the first *four* terms of the binomial formula. State in words, without doing the work, how this formula may be applied to find the value of $\sqrt[4]{33}$ to any required degree of accuracy.
- 40 1900_06_AA_13 Progressions: Geometric
By the method of differences find the sum of eight terms of the series 2, 6, 12, 20, 30, 42, etc.
- 41 1900_06_AA_14 Equations: Literal
Derive a rule for transforming an equation into another whose roots are those of the given equation with contrary signs.
- 42 1900_06_AA_15 Logarithms
Given $\log 8 = .9031$, $\log 9 = .9542$; find $\log 15$, $\log 600$, $\log 4$.
- 43 1909_01_AA_01 Quadratics: $a > 1$
Solve as a quadratic $3x^2 + 15x - 2\sqrt{x^2 + 5x + 1} = 2$
- 44 1909_01_AA_02 Proportions
If $\frac{x}{a-b} = \frac{y}{b-c} = \frac{z}{c-a}$ find the value of $x + y + z$.
[Apply the theorem: "In any continued proportion the sum of all the antecedents is to the sum of all the consequents" etc.]
- 45 1909_01_AA_03 Progressions: Arithmetic
The sum of the first 5 terms of an arithmetical progression is 315; the sum of the first 10 terms is 480. Find the first 12 terms of the series.
- 46 1909_01_AA_04 Conversions
Find the value of the repetend $0.\overline{231}$.
- 47 1909_01_AA_05 Combinatorics: Combinations
In an examination paper there are 12 questions arranged in 3 groups of 4 questions each and the pupil is required to answer 8 questions, selecting at least 2 from each group. How many different selections of questions can he make?
- 48 1909_01_AA_06 Equations: Logarithmic
 $\log x = 0.69897$; find x when $5^x = 10$
- 49 1909_01_AA_07 Graphing Higher Order Equations
Construct carefully the graph of the equation $x^3 - 4x^2 + x + 2 = 0$ and determine by measurement the approximate value of each real root.
- 50 1909_01_AA_08 Equations: Roots of Higher Order
Solve the equation $x^3 - 4x^2 - 3x + 18 = 0$, knowing that two of its roots are real. [Solution by trial not accepted.]
- 51 1909_01_AA_09 Equations: Literal
Transform $4x^3 - 3x^2 - 17x + 11 = 0$ into an equation in which the leading coefficient is unity and the other coefficients are integers.

- 52 1909_01_AA_10 Quadratics: Using the Discriminant
Determine the nature of the roots of the equation
 $x^3 - 2x^2 + 3x + 2 = 0$
- 53 1909_01_AA_11 Numbers: Complex
Show that if $a + b\sqrt{-1}$ is a root of $f(x) = 0$, then
 $a - b\sqrt{-1}$ is also a root.
- 54 1909_01_AA_12 Matrices
Evaluate the determinant $\begin{vmatrix} 1 & 4 & 3 & 1 \\ 3 & 8 & 2 & 5 \\ 6 & 4 & 1 & 2 \\ 2 & 5 & 3 & 3 \end{vmatrix}$
- 55 1909_06_AA_01 Progressions: Arithmetic and Geometric
Three numbers, whose sum is 24, are in arithmetic progression; if 2, 6, 17 are added to them respectively, the results are in geometric progression. Find the numbers.
- 56 1909_06_AA_02 Equations: Forming Higher Order from Roots
Form the equation of the fourth degree with rational coefficients, three of whose roots are 2, -3, $3 + 2\sqrt{-1}$
- 57 1909_06_AA_03 Binomial Expansions: Undetermined Coefficients
Find the first five terms of the series obtained by developing the fraction $\frac{1-x}{1+2x+2x^2}$ by the method of undetermined coefficients. Verify the result by division.
- 58 1909_06_AA_04 Combinatorics: Combinations
In a certain county there are 15 candidates for State scholarships; in how many ways may 5 scholarships be awarded to 3 boys and 3 girls if 6 of the candidates are girls and 9 are boys?
- 59 1909_06_AA_05 Quadratics: Writing
The distance through which a body falls varies as the square of the time of falling. A stone dropped from a window 35 feet 1 inch above the ground strikes the ground in $1\frac{1}{2}$ seconds; one dropped from a bridge strikes the water below in $4\frac{1}{2}$ seconds. Find the height of the bridge above the water.
- 60 1909_06_AA_06 Graphing Higher Order Equations
Plot the graph of $2x^3 + 8x^2 - 10x - 7 = y$ and from the graph determine the location of the roots of the equation formed by making $y = 0$.
- 61 1909_06_AA_07 Logarithms
Given $\log 2 = 0.30103$, $\log 3 = 0.47712$, $\log 7 = 0.84510$; find the logarithms of 84, 81, $\sqrt{7}$ and $\frac{3}{4}$.
- 62 1909_06_AA_08 Equations: Roots of Higher Order
By Horner's method of approximation find the root, correct to *two* decimal places, between 1 and 2 of $x^3 - 9x^2 + 23x - 1\frac{1}{2} = 0$
- 63 1909_06_AA_09 Systems: Three Variables
By determinants find the value of x in the following system of equations:
 $x + 2y + 3z = 1$
 $2x - y - 2z = 6$
 $3x + 3y - z = -5$
- 64 1909_06_AA_10 Series
By the orders of differences find the 10th term and the sum of the first 10 terms of the series 1, 3, 8, 16 . . .
- 65 1920_01_AA_01 Radicals: Operations with
Find the value of $\frac{\sqrt{7} + \sqrt{2}}{\sqrt{7} - \sqrt{2}}$ stating the result to the nearest thousandth.

- 66 1920_01_AA_02 Binomial Expansions
By the aid of the binomial formula, find the value of $(1.045)^7$, that is, $\left(1 + 0.04\frac{1}{2}\right)^7$ correct to the *third* decimal place. Indicate the work necessary to check the result by the use of logarithms.
- 67 1920_01_AA_03 Conversions
Express as a common fraction the value of the repeating decimal $0.4373737 \dots$
- 68 1920_01_AA_04 Combinatorics: Combinations
Find the number of ways in which a combination lock of 100 numbers may be set on three numbers when (a) repetition of these numbers are allowed, (b) repetitions are not allowed.
- 69 1920_01_AA_05 Graphing Higher Order Equations
Represent graphically *each* of the roots of the equation $x^4 - 1 = 0$ and explain from the graph why the sum of the roots is zero.
- 70 1920_01_AA_06 Equations: Roots of Higher Order
Find all the roots of $x^3 + 3x^2 - 30x + 36 = 0$
- 71 1920_01_AA_07 Equations: Literal
Transform the equation $x^3 - 7x^2 + 2 = 0$ into an equation having no second power of the unknown quantity.
- 72 1920_01_AA_08 Equations: Roots of Higher Order
Determine the first significant figure of each real root of the equation $x^3 + 9x^2 + 24x + 17 = 0$
- 73 1920_01_AA_09 Equations: Roots of Higher Order
Find to the nearest thousandth the root of the equation $x^3 - 3x^2 - 4x + 13 = 0$ that lies between 2.3 and 2.4.
- 74 1920_01_AA_10 Systems: Writing Quadratic
Two wheels of a machine are tangent to each other and the distance between their centers is 9 inches. The sum of the areas of the wheels is 198 square inches. Find, to the nearest hundredth of an inch, the radius of each wheel. $\left[\pi = \frac{22}{7}\right]$
- 75 1920_01_AA_11 Quadratics: Solving
An arrow is projected upward with a velocity of 96 feet per second. The relation of initial velocity (V), space described (S) and time (t) being given by the equation $S = Vt - \frac{1}{2}gt^2$, find after how many seconds the arrow will be 80 feet above ground. [Assume that $g = 32$] Are both results possible? Explain.
- 76 1920_01_AA_12 Combinatorics: Combinations
A certain steamship line has eight steamers running between New York and Southampton. In how many ways is it possible to cross from New York to Southampton and return by a different steamer of this line? Write an explanation of the formula or method used in obtaining the result.
- 77 1920_01_AA_13 Equations: Logarithmic
If S is taken as the quantity of common salt that will dissolve in 100 parts by weight of water at t degrees centigrade, it is found that
$$\log S = a + 0.01bt + c(0.01t)^2.$$
Using the table of logarithms, from the following data form (do not solve) the equations, from which can be found the values of a , b and c :
If $t =$ 25 60 80
Then $S =$ 36.13 37.25 38.22
- 78 1920_06_AA_01 Quadratics: Solving
Solve and check: $\frac{x}{x-5} - \frac{x-5}{x} = \frac{3}{2}$

- 79 1920_06_AA_02 Quadratics: Using the Discriminant
For what values of m will the equation
$$\frac{x^2 - x + m - 1}{(x - 1)(m - 1)} = \frac{x}{m}$$
 have two equal values for x ?
- 80 1920_06_AA_03 Radicals: Rationalizing Denominators
a Rationalize the denominator of
$$\frac{x - \sqrt{x^2 - 1}}{x + \sqrt{x^2 - 1}}$$

b Find the value of this expression when $x=4$, evaluating the radical to the nearest hundredth.
- 81 1920_06_AA_04a Progressions: Arithmetic
Find by formula the sum of the first 6 terms of the progression $2\frac{2}{3}, 3\frac{3}{5}, 4\frac{4}{15}, \dots$
- 82 1920_06_AA_04b Logarithms
Using logarithms, find the value of n in the formula
$$n = \frac{1}{2L} \sqrt{\frac{Mg}{m}}$$
 when $L=78.5, M=5468, g=980, m=0.0065$.
- 83 1920_06_AA_05 Equations: Roots of Higher Order
Find all the roots of $x^4 + x^3 - 2x^2 + 4x - 24 = 0$. Check by forming the product of the roots and comparing it with the proper term in the equation.
- 84 1920_06_AA_06 Quadratics: Sum and Product of Roots
Given the equation $3x^3 - x^2 - 5 = 0$
a Write the sum of the roots and the product of the roots.
b Transform to an equation whose roots are twice the roots of the given equation.
c Transform to an equation with integral coefficients, the coefficient of the highest degree term being unity.
- 85 1920_06_AA_07 Graphing Higher Order Equations
a Plot the graph of $x^3 - 7x + 6$ from $x = -4$ to $x = +4$
b What is the greatest value of this expression for values of x between -4 and $+3$?
c From the graph determine the roots of the equation $x^3 - 7x + 6 = 0$
- 86 1920_06_AA_08 Equations: Roots of Higher Order
Find to the nearest hundredth the root of the equation $x^3 + 3x^2 - 4x - 1 = 0$, which lies between 1 and 2.
- 87 1920_06_AA_09a Numbers: Complex
Draw the graph of *each* of the following and of their sum: $3 + \sqrt{-2}, 3 - \sqrt{-2}$
- 88 1920_06_AA_09b Numbers: Complex
In the expression $1 + ix + \frac{i^2x^2}{2} + \frac{i^2x^2}{3!}, x=2$ and $i = \sqrt{-1}$. Find the value of this expression. [$n!$ = factorial n]
- 89 1920_06_AA_10 Combinatorics: Combinations
In a league of 10 basketball teams each team plays two games with every other team. How many weeks will the playing season last if three games are played each week? How many times will any one team play?
- 90 1920_06_AA_11 Equations: Simple with Fractional Expressions
A formula for the flow of water in a long horizontal pipe connected with the bottom of a reservoir is
$$\frac{Hd}{L} = \frac{4v^2 + 5v - 2}{1200}$$
 when H is the depth of the water in the reservoir in feet, d the diameter of the pipe in inches, L the length of the pipe in feet and v the velocity of the water in feet per second. If a reservoir contains 49 feet of water, find the velocity of the water in a 5 inch pipe that is 1000 feet long.

- 91 1920_06_AA_12 Literal Equations
The so-called effective area of a chimney is given by the formula $E = A - \frac{3}{5} \sqrt{A}$ when A is the measured area. Solve this equation for A in terms of E .
- 92 1920_09_AA_01 Numbers: Complex
Represent graphically the complex numbers $5+3i$ and $-1 - 6i$ and also represent their sum.
- 93 1920_09_AA_02 Equations: Literal
Transform the following equation into one whose roots are less than three:
 $3x^4 - 19x^3 + 21x^2 + 31x + 12 = 0$
- 94 1920_09_AA_03 Progressions: Arithmetic and Geometric
There are three numbers in geometric progression whose sum is $19/2$. If the first is multiplied by $2/3$, the second by $2/3$, and the third by $15/27$, the resulting numbers will be in arithmetic progression. What are the numbers?
- 95 1920_09_AA_04 Equations: Roots of Higher Order
Find to the *nearest hundredth* a root of the equation $x^3 + 4x^2 + x + 1 = 0$
- 96 1920_09_AA_05 Quadratics: Using the Discriminant
In the equation $2kx^2 + (5k + 2)x + 4k + 1 = 0$, what is the value of k that will give equal roots?
- 97 1920_09_AA_06 Systems: Writing
Two airplanes fly towards each other, starting at the same time from places 500 miles apart. If the first one travels at a speed of 75 miles an hour, and the difference in the rates of speed is 21 miles more per hour than the number of hours before they meet, how far will each have traveled when they meet?
- 98 1920_09_AA_07 Logarithms
Find by logarithms the value of $50 \times \frac{2^{3.5}}{8^{1.62}} \times \sqrt[3]{2} \times 100^2$ if $\log 2 = .3010$
- 99 1920_09_AA_08 Equations: Forming from Imaginary Roots
Find the equation of lowest degree with rational coefficients two of whose roots are $-5 + 2i$ and $-1 + \sqrt{5}$
- 100 1920_09_AA_09 Systems: Writing Quadratic
A rectangular piece of cloth when wet shrinks one sixth in length and one twelfth in width. If the area is diminished by $12\frac{3}{4}$ square feet and the perimeter by $6\frac{1}{2}$ feet, what are the original dimensions?
- 101 1920_09_AA_10 Combinatorics: Combinations
In how many different ways can two letters be posted in six letter boxes? In how many different ways can they be posted if they are not posted in the same box?
- 102 1930_01_AA_01 Progressions: Geometric
The sum of an infinite geometric series is 12 and the ratio is $\frac{1}{2}$; what is the first term?
- 103 1930_01_AA_02 Logarithms
Find by the use of logarithms the value of $\sqrt[5]{375}$ to the *nearest tenth*.
- 104 1930_01_AA_03 Equations: Higher Order
Find the positive integral root of the equation $x^3 - 2x^2 - 3x + 6 = 0$
- 105 1930_01_AA_04 Progressions: Geometric
Using *one* relation between roots and coefficients, find the positive geometric mean between the roots of $2x^2 - 17x + 14 = 0$
- 106 1930_01_AA_05-08 Equations: Roots of Higher Order
Given the equation $2x^4 + 3x^3 - x^2 + 5x + 5 = 0$
a What is the possible maximum number of positive roots?
b What is the possible maximum number of negative roots?
c What is the possible maximum number of complex roots?
d What is the sum of the roots?

- 107 1930_01_AA_09 Numbers: Complex
Write in the form $x^2 + px + q = 0$, the question whose roots are $2 + i$ and $2 - i$
- 108 1930_01_AA_10 Binomial Expansions
Write the *fifth* term of the expansion $(1 - x)^5$
- 109 1930_01_AA_11 Equations: Literal
If $y^2 + 4y + 4 - x^2 = 0$, express y as a function of x ; that is, solve the equation for y in terms of x .
- 110 1930_01_AA_12 Equations: Literal
Find an equation whose roots are 2 less than the roots of $x^2 - 3x - 7 = 0$
- 111 1930_01_AA_13 Equations: Literal
Transform $2x^3 - 3x^2 - 1 = 0$ into an equation with integral coefficients, the coefficient of the term of highest degree being unity.
- 112 1930_01_AA_14 Numbers: Imaginary
Express $\frac{2i}{1+i}$ in the form $a+bi$
- 113 1930_01_AA_15 Numbers: Imaginary
What kind of number is the sum of two conjugate imaginary numbers?
- 114 1930_01_AA_16 Combinatorics: Combinations
With four flags of different colors, how many different signals can be made by displaying two flags, one above the other?
- 115 1930_01_AA_17 Equations: Logarithmic
Solve for x by the use of logarithms: $a^{bx} = c$
- 116 1930_01_AA_18 Equations and Expressions: Using Substitution in
If the graph of $y = ax^2 - 2x$ passes through the point $(2,8)$, what is the value of a ?
- 117 1930_01_AA_19 Equations and Expressions: Modeling
A man lives 10 miles from town. He starts from his home and walks toward the town at a uniform rate of 3 miles an hour. If t is the number of hours he has walked, express his distance (d) from the town as a function of t .
- 118 1930_01_AA_20 Quadratics: Using the Discriminant
For what value of a will the graph of $y = x^2 + 4x + a$ be tangent to the x -axis?
- 119 1930_01_AA_21 Equations: Roots of Higher Order
Find the three roots of the equation $3x^3 + 4x^2 - 19x + 10 = 0$ [10]
- 120 1930_01_AA_22 Equations: Roots of Higher Order
Find to the *nearest tenth* the real root of $x^3 + 2x - 18 = 0$ [10]
- 121 1930_01_AA_23 Equations: Roots of Higher Order
In the question $x^3 + 4x^2 - x + k = 0$, find the integral value of k for which two of the roots will differ by 3. [10]
- 122 1930_01_AA_24 Notes and Interest
A man deposits \$5000 in a trust company paying 4% interest, compounded annually. At the end of 10 years, he withdraws \$2000. What balance will he have in the bank (a) immediately after making the withdrawal, (b) 10 years after making the withdrawal? [6, 4]
- 123 1930_01_AA_25 Progressions: Arithmetic
The edges of three cubes are in arithmetic progression. The sum of these edges is 15 and the sum of the areas of the cubes is 498. Find an edge of each cube. [4, 6]
- 124 1930_01_AA_26 Systems: Writing
Two men, A and B, plan to drive from the same place to a point 180 miles distant. Both drive at uniform rates. A leaves at noon and B leaves x hours later. At 2 o'clock A is 20 miles ahead of B and at 4 o'clock B is 20 miles ahead of A. B reaches the destination 3 hours before A. At what time did B start? [7, 3]

- 125 1930_01_AA_27 Graphing Higher Order Equations
For the first 6 minutes of the second quarter of a football game the distance in yards from the line of scrimmage of one team to the opponent's goal is given approximately by the formula
 $d = -t^3 + 9t^2 - 24t + 36$
a Plot the graph of this formula for values of t from $t = 0$ to $t = 6$ inclusive. [6]
b How far was the ball from the goal at the beginning of the second quarter? [1]
c How long was the team forced back during this 6-minute interval? [1]
d How far was the ball from the goal when the team again started to advance the ball? [1]
e How many minutes after the beginning of the second quarter did the team make a touchdown? [1]
- 126 1930_06_AA_01 Conversions
Express .270270 . . . as a common fraction.
- 127 1930_06_AA_02 Progressions: Arithmetic
In an arithmetic series of 5 terms, the first term is 3 and the last term is 12; what is the second term?
- 128 1930_06_AA_03 Quadratics: Using the Discriminant
For what values of k will the equation $x^2 + (1 - k)x + 1 = 0$ have *two* equal roots?
- 129 1930_06_AA_04 Numbers: Properties of Real
If x must be a real number, can the fraction $\frac{x^2}{x - 3}$ have the value 2?
[Answer *yes* or *no*.]
- 130 1930_06_AA_05 Quadratics: Solving
If x represents the number of boys in a class, the equation
 $2x^2 - 11x - 30 = 0$
a can not possibly be true.
b must necessarily be true.
c may be either true or false.
Which statement is correct, a , b , or c ?
- 131 1930_06_AA_06 Binomial Expansions
Give, after simplifying, the *third* term in the expansion $\left(\sqrt{x} + \frac{1}{3x^2}\right)^{10}$
- 132 1930_06_AA_07 Numbers: Imaginary
If $x = 1 + 3i$, what is the value of $\frac{x^2}{5 - x}$?
- 133 1930_06_AA_08 Logarithms
If $y = \log_{10} 3$, what is the value of 10^{2y} ?
- 134 1930_06_AA_09 Combinatorics: Combinations
In a baseball league of 6 teams, each team plays each of the other teams twice; how many games are played?
- 135 1930_06_AA_10 Equations: Forming Quadratics from Roots
Write an equation with integral coefficients whose roots are $-1 + \sqrt{3}$, $-1 - \sqrt{3}$, and $\frac{1}{3}$
- 136 1930_06_AA_11 Numbers: Imaginary
What is the exact number of imaginary roots of the equation $x^7 = 1$?
- 137 1930_06_AA_12 Equations: Higher Order
One root of the equation $24x^3 + 5x^2 + 96x + 20 = 0$ is $2i$; what are the two remaining roots?
- 138 1930_06_AA_13 Equations: Higher Order
What is the rational root of the equation $3x^3 + 5x^2 + 5x + 2 = 0$?
- 139 1930_06_AA_14 Equations: Forming New from Modified Roots
Write an equation whose roots are half the roots of $3x^3 - 10x^2 + 24 = 0$
- 140 1930_06_AA_15 Equations: Higher Order
How many times does the graph of $y = x^4 + 6x^2 - x - 11$ cut the x -axis?
- 141 1930_06_AA_16 Combinatorics: Combinations
How many odd numbers of three different digits can be written with the digits 1, 2, 4, 6, and 8?

- 142 1930_06_AA_17 Equations: Simple with Fractional Expressions

If $y = 2 + \frac{1}{1-x}$, does y increase or decrease as x increases from 2 to 10?

- 143 1930_06_AA_18 Equations and Expressions: Modeling

If A's age is now x , and A is twice as old as B was 10 years ago, express the difference y between their ages as a function of x , assuming that A is older than B.

- 144 1930_06_AA_19 Numbers: Complex

On the diagram below, plot the points that represent the complex numbers $5 + \sqrt{-4}$ and $-1 + \sqrt{-25}$

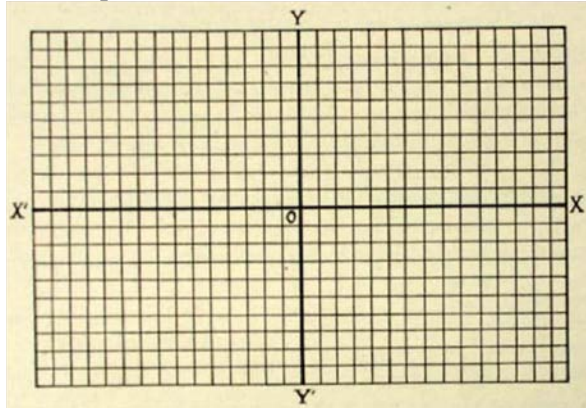

- 145 1930_06_AA_20 Numbers: Complex

Determine graphically the point that represents the sum of the two complex numbers given in question 19.

Note: Question 19 is as follows:

1930_06_AA_19

On the diagram below, plot the points that represent the complex numbers $5 + \sqrt{-4}$ and $-1 + \sqrt{-25}$

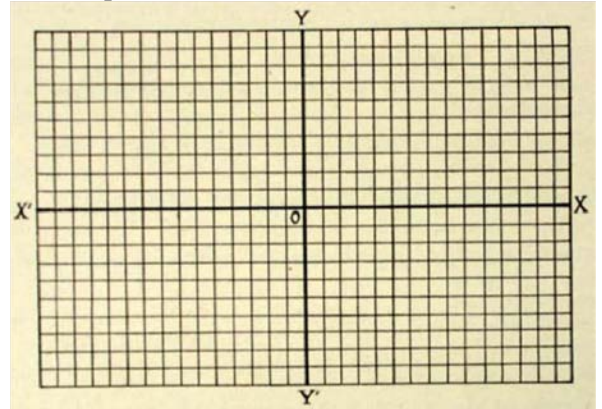

- 146 1930_06_AA_21 Notes and Interest

If the interest at 6% is compounded annually, in how many years will \$1 amount to \$100? [10]

- 147 1930_06_AA_22 Equations: Roots of Higher Order

Find the four roots of $x^4 + 2x^3 - 4x^2 - 5x - 6 = 0$ [10]

- 148 1930_06_AA_23 Volume

A rectangular bin with a square base has a depth of 2 feet greater than one side of the base. If the capacity of the bin is 500 cubic feet, find its dimensions to the *nearest tenth* of a foot. [10]

- 149 1930_06_AA_24 Systems: Other Nonlinear

Does the graph of $y = x^4 - 8x^2 + 16$ intersect the graph of $y = -2x^2$? Show reason for your answer. [10]

- 150 1930_06_AA_25 Equations: Literal
 a Transform the equation $x^3 + 6x^2 + 2x - 5 = 0$ into an equation in which the term of the second degree is missing. [5]
 b What are the roots of the equation $x^3 - 5x^2 + 6x + k = 0$, if the graph of $y = x^3 - 5x^2 + 6x + k$ passes through the origin? [5]
- 151 1930_06_AA_26a Proofs: Algebraic
 Prove that an equation in one unknown all of whose coefficients are integers, the coefficient of the term of highest degree being 1, can not have a rational fraction for a root. [5]
- 152 1930_06_AA_26b Radicals: N-Roots
 Find to the *nearest hundredth* $\sqrt[3]{45}$ [Use logarithms.] [5]
- 153 1930_06_AA_27 Equations and Expressions: Modeling
 At noon A starts from a town and walks at the rate of 2 miles an hour until 2.30 p.m., rests until 3.30 p.m. and then walks on at the rate of 4 miles an hour. B sets out from the town on the same road at 1 p.m. and walks steadily at the rate of 3 miles an hour.
 a On the same set of axes represent these facts graphically for each man for the interval from noon to 7 p.m. inclusive. [7]
 b From the graph made in answer to a, determine
 (1) how far from the starting point each man is at 4 o'clock. [1]
 (2) at what time each of them passes a point on the road 7 miles from the town. [1]
 (3) when and where B passes A. [1]
- 154 1930_08_AA_01 Quadratics: Sum and Product of Roots
 Given the equation $5x^2 - 3x + \frac{1}{2} = 0$
 What is the product of the roots of this equation?
- 155 1930_08_AA_02 Quadratics: Using the Discriminant
 Given the equation $5x^2 - 3x + \frac{1}{2} = 0$
 Are the roots real or imaginary?
- 156 1930_08_AA_03 Logarithms
 By the use of logarithms find the value of 2^{33} to the *nearest million*.
- 157 1930_08_AA_04 Logarithms
 If $y = 10^{2x}$, what is the value of y when $x = \log_{10} 3$?
- 158 1930_08_AA_05 Exponential Functions and Equations
 Find the value of x if $10^{2x} = 100^{1-x}$
- 159 1930_08_AA_06 Equations: Literal
 If $x^2 - 4xy + y^2 = 1$, express y as a function of x ; that is, solve the equation for y in terms of x .
- 160 1930_08_AA_07 Equations and Expressions: Modeling
 A man makes part of a 75 mile trip on foot at the rate of 3 miles an hour, and the remaining distance in a car at 25 miles an hour. If y represents the total time for the trip (in hours), and x the distance he walks (in miles), express y as a function of x .
- 161 1930_08_AA_08 Conversions
 To what common fraction is the repeating decimal .1818... equal?
- 162 1930_08_AA_09 Binomial Expansions
 Find and simplify the *fifth* term in the expansion of $(x + \sqrt{x})^7$
- 163 1930_08_AA_10 Numbers: Complex
 What is the value of $\frac{x^2}{3x-5}$ if $x = 3 - i$

- 164 1930_08_AA_11 Numbers: Complex
What is the distance from the origin to the point representing the complex number $\frac{25}{4-3i}$?
- 165 1930_08_AA_12 Combinatorics: Permutations
Is it possible to seat a class of six pupils in a row of six seats in a different order every day (except Sundays) for two years? [Answer *yes* or *no*.]
- 166 1930_08_AA_13 Combinatorics: Combinations
In how many different ways may a committee of two be selected from a senior class of 100?
- 167 1930_08_AA_14 Quadratics: Sum and Product of Roots
If the sum of the roots of the following equation in x is 6, find the products of the roots:
$$kx^3 + (k+1)x^2 + (k+2)x + 5 = 0$$
- 168 1930_08_AA_15 Equations: Forming Higher Order from Roots
Form an equation whose coefficients are integers and whose roots are 2, -3 and $\frac{1}{5}$.
- 169 1930_08_AA_16 Equations: Roots of Higher Order
How many complex roots has the equation $x^3 + 2x^2 + 7x - 5 = 0$?
- 170 1930_08_AA_17 Equations: Forming New from Modified Roots
Write an equation whose roots are half as large as the roots of $3x^3 - 2x^2 + 40 = 0$
- 171 1930_08_AA_18 Equations: Forming New from Modified Roots
Write an equation whose roots are 3 less than the roots of $2x^2 + 5x - 1 = 0$
- 172 1930_08_AA_19 Equations: Forming from Imaginary Roots
Form an equation whose coefficients are real and two of whose roots are $\sqrt{-1}$ and $\sqrt{-3}$
- 173 1930_08_AA_20 Quadratics: Using the Discriminant
The graph of $y = 3x^2 + 2x - 5$ cuts the x -axis (a) not at all, (b) only once, (c) more than once.
Which is correct, a , b , or c ?
- 174 1930_08_AA_21 Equations: Higher Order
Find all the roots of the equation $3x^4 - 4x^3 + 5x^2 - 16x - 28 = 0$ [10]
- 175 1930_08_AA_22 Proofs: Algebraic
State and prove the Remainder Theorem for any polynomial in x . [10]
- 176 1930_08_AA_23 Equations: Higher Order
Find to the *nearest hundredth* the real root of $2x^3 - 5x^2 = 10$ [10]
- 177 1930_08_AA_24 Notes and Interest
A sum of \$1000 is divided into two portions. The first portion is placed at simple interest at 6%, and the second at compound interest at 4%, compounded annually. At the end of 10 years, the total amount (principal and interest) is \$1539.50. Find the two portions. [10]
- 178 1930_08_AA_25 Rate, Time and Distance
A man can row 24 miles down a river in one hour less time than he requires to row 12 miles down and back; he can row 12 miles down and back in exactly the same time he needs to row 20 miles upstream. Find his rate of rowing in still water and the rate of the current. [7,3]
- 179 1930_08_AA_26a Progressions: Arithmetic
If the roots of $x^4 - 12x^2 + hx + k = 0$ are in arithmetic progression, show that $k + 4h = 128$.

- 180 1930_08_AA_27 Triangles: Pythagoras
One leg of a right triangle is to be one inch shorter than the hypotenuse. Letting y represent the area of the triangle and x the hypotenuse, express y as a function of x . Plot the graph of this equation for values of x from $x = 1$ to $x = 5$ inclusive, calculating the values of y to the *nearest tenth*. From your graph determine approximately the hypotenuse of such a triangle when the area is 5 square inches. [3, 6, 1]
- 181 1940_01_AA_01 Points on a Line: Identification of
What is the y intercept of the line whose equation is $2x - 3y = 6$?
- 182 1940_01_AA_02 Slope
What is the slope of the line whose equation is $\frac{x}{3} - \frac{y}{2} = 1$?
- 183 1940_01_AA_03 Slope Intercept Form of a Line
What is the equation of the line which passes through the point $(0, -2)$ and whose slope is $\frac{2}{3}$?
- 184 1940_01_AA_04 Central Tendency: Averages
What is the arithmetic mean between $2a$ and $2b$?
- 185 1940_01_AA_05 Progressions: Geometric
Insert a positive geometric mean between 1.28 and 128.
- 186 1940_01_AA_06 Polynomials: Multiplication and Division of
What is the remainder when $2x^{33}$ is divided by $x+1$?
- 187 1940_01_AA_07 Binomial Expansions
Write the first three terms of the expansion of $(1+x)^n$
- 188 1940_01_AA_08 Exponents
What is the real value of $\left(\frac{2^0}{8^{\frac{1}{3}}} \right)^{-1}$?
- 189 1940_01_AA_09 Equations: Roots of Higher Order
According to Descartes' rule of signs, must the equation $x^4 - 3x^3 + 5x^2 - 7x + 16 = 0$ have four positive roots?
[Answer *yes* or *no*.]
- 190 1940_01_AA_10 Equations: Literal
Transform the equation $x^4 + 8x^3 + 23x^2 + 28x + 13 = 0$ into an equation whose roots are greater by 2 than the roots of the given equation.
- 191 1940_01_AA_11 Quadratics: Solving
If p and $-q$ are the roots of $ax^2 + bx + c = 0$, what are the roots of the equation $ax^2 - bx + c = 0$?
- 192 1940_01_AA_12 Equations: Forming New from Modified Roots
Write the equation whose roots are one half the roots of the equation $x^2 - 8x + 8 = 0$
- 193 1940_01_AA_13 Equations: Roots of Higher Order
Two roots of an equation of the fourth degree with real coefficients are $2+i$ and $-2+i$. What are the other roots?
- 194 1940_01_AA_14 Logarithms
If $x = \log 3$, what is the value of 10^x ?
- 195 1940_01_AA_15 Radicals: N-Roots
Find, correct to the *nearest tenth*, the value of $\sqrt[3]{5.402}$
- 196 1940_01_AA_16 Systems: Other Nonlinear
In how many points does the graph of $x^2 - y^2 = 16$ intersect the graph of $xy = 16$?
- 197 1940_01_AA_17 Variation: Inverse
Write as an equation the following statement: The weight (W) of an object varies inversely as the square of its distance (d) from the center of the earth.

- 198 1940_01_AA_18 Combinatorics: Combinations
On an algebra examination a student is allowed to choose 5 questions out of 9. In how many ways can he choose the 5 questions?
- 199 1940_01_AA_19 Probability: Theoretical
Five discs in a bag are numbered 1 to 5. What is the probability that the sum of the numbers on three discs picked at random will be greater than 10?
- 200 1940_01_AA_20 Equations: Higher Order
In an equation of the third degree only the first two terms are legible: $x^3 - 3x^2 \dots = 0$. Two roots of the equation are known to be 2 and -3. What is the third root?
- 201 1940_01_AA_21 Equations: Higher Order
Solve completely: $3x^4 + 8x^3 - 9x^2 - 16x + 6 = 0$ [10]
- 202 1940_01_AA_22 Equations: Higher Order
Find, correct to the *nearest tenth*, the real root of the equation $2x^3 - 6x - 9 = 0$ [10]
- 203 1940_01_AA_23 Radicals: Solving
LaPlace's formula for determining the velocity of sound in the air (in meters per second) is $V = \sqrt{\frac{kP}{d}}$, where P is the barometric pressure in dynes per square centimeter and d is the density of the air in grams per cubic centimeter. If $P=1,013,000$, $d=.0013$, and $k=.000142$ by the use of logarithms find V correct to the nearest integer. [10]
- 204 1940_01_AA_24 Proofs: Algebraic
Given $(c + id)^3 + q(c + id) + r = 0$, in which q and r are real
Prove $(c - id)^3 + q(c - id) + r = 0$ [10]
- 205 1940_01_AA_25 Rate, Time and Distance
A and B started at the same time to walk from two towns 12 miles apart. They walked in the same direction along the same road and A overtook B six hours after they started. Had they walked toward each other they would have met in two hours. What were their rates of walking? [10]
- 206 1940_01_AA_26 Systems: Three Variables
Given $x + y + z = 100$
 $10x + 3y + \frac{1}{2}z = 100$
a) Express x as a function of y . [6]
b) If x , y , and z are positive integers, determine the values of x , y , and z that will satisfy the given equations. [4]
- 207 1940_01_AA_27 Systems: Other Nonlinear
a) On the same set of axes, plot the graph of $xy=16$ and $y^2 = 6x$ [4,4]
b) From the graphs made in answer a, estimate, correct to the nearest tenth the values of x and y common to the two equations.
- 208 1940_01_AA_28 Numbers: Complex
a) Find the modulus of $5+12i$ [2]
b) Express $1-i$ in polar form. [4]
c) Express $2(\cos 90^\circ + i \sin 90^\circ)$ in the form $a+bi$ [4]
* This question is based on one of the optional topics in the syllabus.

- 209 1940_01_AA_29 Central Tendency: Normal Distributions
On an examination in advanced algebra the grades (to the nearest 5%) earned by 100 pupils were distributed as follows:
- | | | | | | | | |
|------------------|----|-----|----|----|----|----|----|
| Grades | 55 | 60 | 65 | 70 | 75 | 80 | 85 |
| 90 | 95 | 100 | | | | | |
| Number of Pupils | 2 | 3 | 5 | 12 | 16 | 24 | 14 |
| 10 | 8 | 8 | | | | | |
- a) Which grade most nearly represents the mode? [2]
b) Which grade most nearly represents the median? [2]
c) Compute the arithmetic mean. [5]
d) Is the distribution fairly "normal"? [1]
* This question is based on one of the optional topics in the syllabus.
- 210 1940_06_AA_01 Conics
What is the name of the curve whose equation is $x^2 - y^2 = 25$?
- 211 1940_06_AA_02 Equations: Writing Linear
Write the equation of the line which passes through the point (3, 0) and has a slope of 2.
- 212 1940_06_AA_03 Exponential Functions and Equations
Solve for x in the equation $9^x = 27$.
- 213 1940_06_AA_04 Equations: Higher Order
What is the rational root of the equation $x^5 + x^4 + x^2 + 2x + 1 = 0$?
- 214 1940_06_AA_05 Combinatorics: Combinations
How many numbers of three figures each can be formed from the digits 1 through 9 inclusive if no digit is used twice in any number?
- 215 1940_06_AA_06 Equations: Higher Order
Given the equation $x^3 + bx^2 + cx + d = 0$ in which the coefficients b, c and d represent real numbers; find the value of d if 1 and $2 + i$ are two roots of the equation.
- 216 1940_06_AA_07 Equations: Forming New from Modified Roots
Write the equation whose roots are one third the roots of the equation $x^3 - 18x + 54 = 0$
- 217 1940_06_AA_08 Equations: Forming New from Modified Roots
Write the equation whose roots are less by three than the roots of the equation $x^3 - 9x^2 + 27x - 26 = 0$
- 218 1940_06_AA_09 Quadratics: Writing
Write as an equation the following statement: The pressure (P) of wind on a given sail varies as the square of the wind's velocity (V).
- 219 1940_06_AA_10 Numbers: Imaginary
Indicate the correct answer to by writing *Yes* or *No*. Is the quotient of two imaginary numbers always an imaginary number?
- 220 1940_06_AA_11 Numbers: Imaginary
Indicate the correct answer to by writing *Yes* or *No*. Is a root of a negative number always an imaginary number?
- 221 1940_06_AA_12 Graphing Higher Order Equations
Indicate the correct answer by writing *Yes* or *No*. In the function $y = ax^3 + bx^2 + cx + d$, the coefficients a, b, c and d represent real numbers. Does the graph of the function always intersect the x axis?
- 222 1940_06_AA_13 Equations: Higher Order
Indicate the correct answer by writing *Yes* or *No*. Does the equation $x^6 - 4x^3 - 7 = 0$ have a negative root?
- 223 1940_06_AA_14 Exponential Functions and Equations
Indicate the correct answer by writing *Yes* or *No*. Is the graph of $y = 10^x$ symmetric with respect to the y axis?
- 224 1940_06_AA_15 Radicals: N-Roots
Find, correct to the *nearest hundredth*, the *fifth* root of 77.4.
- 225 1940_06_AA_16 Binomial Expansions
Write in simplest for the third term in the expansion of $\left(1 + \frac{1}{x}\right)^2$

- 226 1940_06_AA_17 Exponents
Find the real value of $\left(x^{-\frac{1}{3}} + \frac{x^0}{2}\right)^x$ when $x = 8$.
- 227 1940_06_AA_18 Equations: Literal
Given $S = \frac{ab}{a+b}$; express b as a function of S and a .
- 228 1940_06_AA_19 Combinatorics: Multiplication Counting Principle
How many different meals consisting of soup, meat, salad, dessert and a drink could a person choose from a menu offering two soups, five meat courses, two salads, four desserts and three drinks?
- 229 1940_06_AA_20 Probability: Independent Events
One letter is to be taken at random from each of the words *factor* and *father*. What is the probability that the same letter will be taken from each?
- 230 1940_06_AA_21 Equations: Higher Order
Solve the equation $2x^4 - x^3 - 14x^2 - 5x + 6 = 0$ [10]
- 231 1940_06_AA_22 Equations: Higher Order
Find correct to the nearest tenth, the positive root of the equation $x^3 + x^2 - 4x - 3 = 0$ [10]
- 232 1940_06_AA_23 Notes and Interest
In how many years will a sum of money double itself if the interest rate is 5%, compounded semiannually? [Use $A = P\left(1 + \frac{r}{2}\right)^{2n}$] [10]
- 233 1940_06_AA_24 Systems: Other Nonlinear
a) On the same set of axes, plot the graphs of $(x-2)^2 + y^2 = 4$ and $y = \frac{(x-2)^2}{2}$ [4, 4]
b) From the graphs made in answer to *a*, estimate correct to the nearest tenth, two values of x and of y , common to both equations.
- 234 1940_06_AA_25 Rate, Time and Distance
A cyclist and an autoist start at the same time from *A* for *B*, a town 60 miles away. They travel over the same route at 8 and 36 miles an hour respectively. When the autoist reaches *B*, he stops 20 minutes for lunch and then starts back. How many hours has the cyclist traveled when he meets the autoist on the return trip? [10]
- 235 1940_06_AA_26 Polynomials: Multiplication and Division of
a) State and prove the Remainder Theorem. [1, 4]
b) State and prove the Factor Theorem. [1, 2]
c) Show in two different ways that when $x^3 - 3x^2 + 5x - 3$ is divided by $x - 2$, the remainder is 3. [2]
- 236 1940_06_AA_27 Progressions: Arithmetic and Geometric
If x , y and z are in geometric progression, prove that $\frac{1}{y-x}$, $\frac{1}{2y}$, and $\frac{1}{y-z}$ are in arithmetic progression. [10]
- 237 1940_06_AA_28 Graphing Higher Order Equations
Given: $y = \frac{1}{2}x^3 - \frac{1}{2}x^2 - 6x + 5$
a) Find the coordinates of the maximum and the minimum points. [6]
b) Find the coordinates of the point of inflection. [2]
c) Sketch the curve. [2]
* This question is based on one of the optional topics in the syllabus.
- 238 1940_06_AA_29 Trigonometry: Polar Form
a) Express $4\sqrt{2} - 4i\sqrt{2}$ in polar form. [4]
b) Using the relation $[p(\cos \theta + i \sin \theta)]^2 = p^2(\cos 2\theta + i \sin 2\theta)$, show that
(1) $\cos 2\theta = \cos^2 \theta - \sin^2 \theta$
(2) $\sin 2\theta = 2 \sin \theta \cos \theta$ [6]
* This question is based on one of the optional topics in the syllabus.

AA - The Advanced Algebra Curriculum (1950)

- 239 1950_01_AA_01 Radicals: Rationalizing Denominators
Express $\frac{6+i}{2-i}$ as a fraction with a real denominator.
- 240 1950_01_AA_02 Variation: Inverse
If y varies directly as x and inversely as z , and if $y = 8$ when $x = 2$ and $z = 3$, find x when $y = 2$ and $z = 24$.
- 241 1950_01_AA_03 Equations: Writing Linear
Write an equation of the line through the point $(-1, 3)$ parallel to the line whose equation is $3x - 2y = 6$.
- 242 1950_01_AA_04 Systems: Quadratic Linear
When the graphs of the equations $xy = 8$ and $y = x^2 + 2$ are plotted on the same set of axes, how many points do the graphs have in common?
- 243 1950_01_AA_05 Binomial Expansions
Write in simplest form the third term in the expansion of $\left(\frac{x}{2} + 2y\right)^2$.
- 244 1950_01_AA_06 Polynomials: Factoring
For what value of k is $x - 3$ a factor of $kx^2 - 11x + 6$?
- 245 1950_01_AA_07 Polynomials: Multiplication and Division of
Find the remainder when $3x^7 + 6$ is divided by $x - 1$.
- 246 1950_01_AA_08 Equations: Higher Order
Find the rational root of $2x^3 - 3x^2 + 3x - 1$.
- 247 1950_01_AA_09 Quadratics: Sum and Product of Roots
Find the sum of the roots of $x^3 + px^2 + qx + r = 0$.
- 248 1950_01_AA_10 Equations: Degrees of
An equation with real coefficients has $2 + 3i$ and $1 - 4i$ among its roots. What is the lowest possible degree of the equation?
- 249 1950_01_AA_11 Equations: Forming New from Modified Roots
Write an equation whose roots are the roots of $2x^3 + 3x^2 + x + 4 = 0$, each increased by 2.
- 250 1950_01_AA_12 Equations: Forming New from Modified Roots
Write an equation whose roots are the roots of $x^3 + 2x^2 - 3x + 1 = 0$, each multiplied by 2.
- 251 1950_01_AA_13 Logarithms
If $\log x = a$, $\log y = b$, $\log z = c$, express $\log \frac{x^{2y}}{\sqrt{z}}$ in terms of a , b and c .
- 252 1950_01_AA_14 Logarithms
Find $\log 32$ to the *nearest tenth*.
- 253 1950_01_AA_15 Radicals: N-Roots
Find $\sqrt[5]{24.1}$ to the *nearest hundredth*.
- 254 1950_01_AA_16 Combinatorics: Permutations
In how many different ways can five boys line up for a race if the smallest boy is always to run in the left lane?
- 255 1950_01_AA_17 Probability: Theoretical
A man has 5 Jefferson nickels and 4 buffalo nickels. If he selects one coin at random, what is the probability that it is a buffalo nickel?
- 256 1950_01_AA_18 Combinatorics: Combinations
If the number of combinations of n things taken 2 at a time is 15, find n .
- 257 1950_01_AA_19 Functional Notation
If $f(x) = x^2 - x$, find $f(2 - y)$.
- 258 1950_01_AA_20 Equations: Literal
If $x^2 - xy - y^2 = 0$, express x in terms of y .

- 259 1950_01_AA_21 Equations: Higher Order
Find, to the *nearest tenth*, the real root of $x^3 - 6x - 12 = 0$ [10]
- 260 1950_01_AA_22 Equations: Higher Order
Find all the roots of $x^4 + 2x^3 - 3x^2 - 4x + 4 = 0$ [10]
- 261 1950_01_AA_23 Central Tendency: Normal Distributions
The normal or probability curve used in statistics has for one form of its equation $y = 0.3989 \frac{e^{-x^2}}{e^2}$ where $e = 2.718$. If $x = 0.4$, find y to the *nearest hundredth*. [10]
- 262 1950_01_AA_24 Systems: Quadratic Linear
For what positive value of k will the line whose equation is $x - 2y = k$ be tangent to the curve whose equation is $x^2 + y^2 = 9$, when the graphs are drawn on the same set of axes? [10]
- 263 1950_01_AA_25 Systems: Other Nonlinear
a) Using the same set of axes, draw the graphs of $(x - 3)^2 + y^2 = 4$ and $y = x^2 + 4$. [4, 4]
b) From these graphs estimate to *tenths* the values of x and y that satisfy both equations. [2]
- 264 1950_01_AA_26 Alligation
A man wants to obtain 15 gallons of a 24% alcohol solution by combining a quantity of 20% alcohol solution, a quantity of 30% alcohol solution and 1 gallon of pure water. How many gallons of each of the alcohol solutions must he use? [10]
- 265 1950_01_AA_27 Proofs: Algebraic
If $\frac{1}{b-a}$, $\frac{1}{2b}$, $\frac{1}{b-c}$ are in arithmetical progression, prove that a , b , c are in geometrical progression. [10]
- 266 1950_01_AA_28 Trigonometry: Polar Form
a) Express $-2i$ in the form $p(\cos \theta + i \sin \theta)$. [3]
b) Express $4(\cos 210^\circ + i \sin 210^\circ)$ in the form $a + bi$. [3]
c) Express in polar form one of the imaginary roots of the equation $x^5 - 1 = 0$. [4]
* This question is based on one of the optional topics in the syllabus.
- 267 1950_01_AA_29 Calculus: Differential
Given $y = \frac{1}{3}x^3 - 4x^2 + 15x - 6$.
a) Find the coordinates of the maximum point. [5]
b) Find the equation of the line tangent to the curve at the point where the curve crosses the y axis. [5]
* This question is based on one of the optional topics in the syllabus.
- 268 1950_06_AA_01 Numbers: Complex
Express $\frac{5+i}{3-2i}$ in the form $a + bi$.
- 269 1950_06_AA_02 Conversions
Express the repeating decimal $0.434343 \dots$ as a common fraction.
- 270 1950_06_AA_03 Variation: Inverse
Using k as the constant of variation, write an equation expressing the relationship: R varies directly as L and inversely as the square of D .
- 271 1950_06_AA_04 Binomial Expansions
Write in simplest form the *third* term of the expansion $\left(x^2 - \frac{1}{x}\right)^5$
- 272 1950_06_AA_05 Parallel and Perpendicular Lines
Write an equation of the straight line passing through the point $(6, -2)$ and parallel to the line $y = 3x - 5$.

- 273 1950_06_AA_06 Systems: Other Nonlinear
If the graphs of $x^2 + 9y^2 = 25$ and $y = x^2$ are drawn on the same set of axes, how many points do the graphs have in common?
- 274 1950_06_AA_07 Exponential Functions and Equations
Solve for x : $9^x = \frac{1}{3}$
- 275 1950_06_AA_08 Exponential Functions and Equations
If $f(x) = x^{\frac{2}{3}} - 3x^0$, find the value of $f(8)$.
- 276 1950_06_AA_09 Polynomials: Multiplication and Division of
Find the remainder when $x^{25} + 2$ is divided by $x - 1$.
- 277 1950_06_AA_10 Quadratics: Sum and Product of Roots
Find the sum of the roots of the equation $5x^4 - 6x^3 - 1 = 0$.
- 278 1950_06_AA_11 Equations and Expressions: Modeling
Write an equation, with rational coefficients and of lowest degree possible, two of whose roots are 1 and $3 + \sqrt{2}$.
- 279 1950_06_AA_12 Numbers: Complex
In which quadrant is the graph of the complex number $-2 + 3i$ located?
- 280 1950_06_AA_13 Equations: Literal
Transform the equation $x^3 + 4x^2 - 34 = 0$ into an equation whose roots are those of the original equation, each *increased* by 1.
- 281 1950_06_AA_14 Equations: Literal
Transform the equation $x^3 - 15x^2 + 9x - 108 = 0$ into an equation whose roots are those of the original equation, each *divided* by 3.
- 282 1950_06_AA_15 Exponential Functions and Equations
Solve for x to the *nearest tenth*: $10^x = 40$
- 283 1950_06_AA_16 Combinatorics: Combinations
How many different juries, each of 12 people, can be selected from a panel of 15 people?
- 284 1950_06_AA_17 Combinatorics: Multiplication Counting Principle
How many code words, each of five different letters, can be formed from the letters a, b, c, d and e , if the first and last letters are to be vowels?
- 285 1950_06_AA_18 Probability: Mutually Exclusive Events
If the probability that an event will happen is $\frac{a}{b}$, find the probability that the event will not happen.
- 286 1950_06_AA_19 Equations: Roots of Higher Order
Find the abscissa of the point where the graph of $y^2 = 8 - x^3$ crosses the x -axis.
- 287 1950_06_AA_20 Quadratics: Axis of Symmetry
The equation of the axis of symmetry of the parabola $y = x^2 + px + q$ is $x = 3$. Find the value of p .
- 288 1950_06_AA_21 Equations: Roots of Higher Order
Find, to the *nearest tenth*, the real root of the equation $x^3 + 2x^2 + x - 1 = 0$. [10]
- 289 1950_06_AA_22 Equations: Roots of Higher Order
Solve the equation $x^4 - 5x^3 + 7x^2 + 3x - 10 = 0$. [10]
- 290 1950_06_AA_23 Radicals: Solving
When a load of T tons is put on a cast-iron strut whose length is L feet and whose diameter is D inches, the minimum diameter of the strut necessary to carry the load without crushing is given by the formula $D = \sqrt[3.6]{\frac{TL^{1.7}}{50}}$.
Find D to the *nearest tenth of an inch* when $T = 6.3$ tons and $L = 20$ feet. [10]

- 291 1950_06_AA_24 Systems: Other Nonlinear
a Draw the graph of $y = 2^{x+1}$ from $x = -3$ to $x = 2$. [5]
b On the same axes as used in answer to *a*, draw the graph of $y = 4 - x^2$ from $x = -2$ to $x = 2$. [3]
c From the graphs made in answer to *a* and *b*, estimate, to the *nearest tenth*, the roots of the equation $4 - x^2 = 2^{x+1}$. [2]
- 292 1950_06_AA_25 Rate, Time and Distance
 A boat is anchored 3 miles from a straight shore. A camp *C* is located on the shore 10 miles from *A*, the point on the shore nearest the boat. A man walks a certain distance from *C* toward *A* at 3 miles an hour. He then rows straight to the boat at 4 miles an hour. If the entire trip took him $3\frac{1}{4}$ hours, how many hours did he walk? [6, 4]
- 293 1950_06_AA_26 Circles: Equations of
 The circle whose equation is $x^2 + y^2 + ax + by + c = 0$ passes through the points (0,0), (6,3) and (3, -6). Find *a*, *b* and *c*. [10]
- 294 1950_06_AA_27a Logarithms
 Prove that $\log_b x = \frac{\log_a x}{\log_a b}$ [5]
- 295 1950_06_AA_27b Progressions: Arithmetic and Geometric
 If three positive numbers, *a*, *b* and *c*, are in geometric progression, prove that $\log a$, $\log b$ and $\log c$ are in arithmetic progression. [5]
- 296 1950_06_AA_28 Trigonometry: Polar Form
a Find the modulus of $-1 + \frac{4}{3}i$. [2]
b Find, to the *nearest degree*, the amplitude (angle) of $-1 + \frac{4}{3}i$. [3]
c Express $4(\cos 135^\circ + i \sin 135^\circ)$ in the form $a + bi$. [3]
d Write *one* of the imaginary roots of the equation $x^4 - 1 = 0$ in polar form. [2]
 *This question is based upon one of the optional topics in the syllabus.
- 297 1950_06_AA_29 Calculus: Differential
 Given $f(x) = \frac{x^3}{3} + x^2 - 3x - 5$.
a Find the first derivative of $f(x)$. [2]
b Find the coordinates of the maximum and of the minimum point. [4]
c Find the coordinates of the point of inflection. [2]
d *Sketch* the graph of $y = f(x)$. [2]
 *This question is based upon one of the optional topics in the syllabus.
- 298 1960_01_AA_01 Numbers: Complex
 Express $\frac{5}{2-i}$ in the form of $a + bi$.
- 299 1960_01_AA_02 Parallel and Perpendicular Lines
 Write an equation on the line that passes through the point (3, -2) and that is parallel to the line whose equation is $2x - 3y = 4$.
- 300 1960_01_AA_03 Quadratics: Using the Discriminant
 For what value of *k* will the graph of $y = x^2 - 8x + k$ be tangent to the *x*-axis?
- 301 1960_01_AA_04 Binomial Expansions
 Write in simplest form the fourth term *only* in the expansion of $\left(x^2 + \frac{2}{x}\right)^6$
- 302 1960_01_AA_05 Polynomials: Multiplication and Division of
 Find the remainder when $3x^9 + 2x^6 - 3$ is divided by $x + 1$.

- 303 1960_01_AA_06 Exponential Functions and Equations
Solve for x : $4^x = \frac{1}{8}$
- 304 1960_01_AA_07 Exponential Functions and Equations
Find the real root of the equation $x^{\frac{3}{2}} = \frac{8}{27}$
- 305 1960_01_AA_08 Equations: Logarithmic
Find the x -intercept of the graph of $y = \log_5 x$.
- 306 1960_01_AA_09 Radicals: N-Roots
Find to the nearest hundredth the value of $\sqrt[3]{0.257}$
- 307 1960_01_AA_10 Fractions: Complex
Express in simplest form $\frac{1 + \frac{2}{a-2}}{1 - \frac{a-5}{a-2}}$
- 308 1960_01_AA_11 Equations: Roots of Higher Order
Two of the roots of the equation $2x^3 - 3x^2 + px + q = 0$ are 3 and -2. Find the third root.
- 309 1960_01_AA_12 Polynomials: Factoring
If $f(x) = x^2 + 4x$, express $f(a-2)$ as a product of two binomials.
- 310 1960_01_AA_13 Exponents
Find the value of $3x^6 + \left(\frac{4}{x}\right)^2 + \sqrt[3]{x^2}$ if $x = 8$
- 311 1960_01_AA_14 Functional Notation
If $f(x)$ is identically equal to $(x-8)Q(x) + 7$, find the numerical value of $f(8)$.
- 312 1960_01_AA_15 Rationals: Solving
Solve for x : $a^2 = \frac{1-x}{1+x}$
- 313 1960_01_AA_16 Combinatorics: Combinations
An algebra examination contains 8 questions. Each student is to answer the first question and any 4 others. How many different sections of 5 questions may be made?
- 314 1960_01_AA_17 Combinatorics: Multiplication Counting Principle
How many *odd* numbers of 3 digits each can be written with the digits 1, 2, 3, 4, 5 if no digits are to be repeated?
- 315 1960_01_AA_18 Probability: Independent Events
A bag contains 3 black balls and 4 white balls. If 2 balls are drawn from the bag, what is the probability that both will be black?
- 316 1960_01_AA_19 Variation: Inverse
Using k as a constant of variation, write an equation that represents the relationship: x varies directly as y and inversely as the square of z .
- 317 1960_01_AA_20 Slope
The slope of the line that passes through the points $(-2, 3)$ and $(5, y)$ is $-\frac{4}{7}$. Find the value of y .
- 318 1960_01_AA_21 Conversions
Express the repeating decimal $0.636363 \dots$ as a common fraction.
- 319 1960_01_AA_22 Systems: Other Nonlinear
If the graphs of $4x^2 + y^2 = 16$ and $y = 2x^2 - 2$ are drawn on the same set of axes, the number of points they will have in common is (1) 1 (2) 2 (3) 3 (4) 4
- 320 1960_01_AA_23 Quadratics: Axis of Symmetry
The equation of the axis of symmetry of the parabola $y = ax^2 - 4x + 1$ is $x = 1$. The value of a is (1) -2 (2) +2 (3) -4 (4) +4
- 321 1960_01_AA_24 Quadratics: Solving
The equation $\sqrt{x+6} - x = 0$ has (1) no root (2) -2 as its only root (3) 3 as its only root (4) the two roots 3 and -2

- 322 1960_01_AA_25 Rate
One machine can complete a job in p minutes and a second machine can do the job in q minutes. If both machines work together, the time in minutes required to complete the job is
- (1) $\frac{pq}{p+q}$ (2) $\frac{p+q}{2}$ (3) $\frac{p+q}{pq}$ (4) $p+q$
- 323 1960_01_AA_26 Equations: Roots of Higher Order
Write an equation whose roots are the roots of $x^3 - 2x^2 + x - 3 = 0$ each decreased by 2.
- 324 1960_01_AA_27 Equations: Roots of Higher Order
Write an equation whose roots are the roots of $x^3 + 2x - 2 = 0$ each multiplied by 3.
- 325 1960_01_AA_28 Equations: Roots of Higher Order
How many of the roots of the equation $2x^6 - 3x^2 - 6 = 0$ are imaginary?
- 326 1960_01_AA_29 Equations: Roots of Higher Order
Find the rational root of $3x^3 + 7x^2 + 8x + 2 = 0$.
- 327 1960_01_AA_30 Equations: Roots of Higher Order
Between what two consecutive integers does the positive root of the equation $x^3 + 3x - 20 = 0$ lie?
- 328 1960_01_AA_31 Equations: Roots of Higher Order
A positive root of the equation $x^3 + 3x^2 + 8x - 4 = 0$ lies between 0.4 and 0.5. Find this root to the nearest tenth.
- 329 1960_01_AA_32 Equations: Roots of Higher Order
Find all the roots of the equation $x^4 + 8x^2 - 9 = 0$.
- 330 1960_01_AA_33 Equations: Literal
If $y = x^2 - 3x$, express x in terms of y .
- 331 1960_01_AA_34 Calculus: Integral
Which one of the following is a rational integral function in x ?
- (1) $2x^2 - \sqrt{x} - 1$
(2) $\frac{2}{3}x^2 - x\sqrt{3} - 5$
(3) $x^2 - \frac{3}{x} - 5$
(4) $x^{\frac{2}{3}} - x - 5$
- 332 1960_01_AA_35 Combinatorics: Combinations
If ${}_{60}C_{12} = {}_nC_3$ Find n .
- 333 1960_01_AA_36 Equations: Forming Higher Order from Roots
Write an equation with integral coefficients and of lowest possible degree, two of whose roots are 3 and i .
- 334 1960_01_AA_37 Equations: Roots of Higher Order
[Write the *number* preceding the correct answer in the space provided.]
The graph of the equation $y = x^3 + 5x + 1$
- (1) does not intersect the x -axis
(2) intersects the x -axis in one and only one point
(3) intersects the x -axis in exactly three points
(4) intersects the x -axis in more than three points
- 335 1960_01_AA_38 Quadratics: Find Vertex Given Equation
An arrow is shot vertically upward. Its height h in feet after t seconds is given by the formula $h = 128t - 16t^2$. After how many seconds will it reach its maximum height?
* This question is based on an optional topic in the syllabus.
- 336 1960_01_AA_39 Calculus: Differential
Find the abscissa of the point of inflection of the graph of $y = x^3 - 3x^2 - 9x + 2$.
* This question is based on an optional topic in the syllabus.

- 337 1960_01_AA_40 Calculus: Differential
Find the slope of the line tangent to the graph of $y = x^2 - 3x - 1$ at the point (4,3).
* This question is based on an optional topic in the syllabus.
- 338 1960_01_AA_41 Progressions: Arithmetic
The first three terms of an arithmetic progression are x , $(2x + 1)$ and $(5x - 4)$. Find the value of x .
- 339 1960_01_AA_42 Logarithms
Find $\log_3 15.4$ to the *nearest tenth*.
- 340 1960_01_AA_43 Exponents
Find to the *nearest tenth* the value of $(26.3)^{1.4}$.
- 341 1960_01_AA_44 Logarithms
If $y = 3^x$ and $x = \log_a y$, find the value of a .
- 342 1960_01_AA_45 Equations: Logarithmic
If $a^x = b^{x+1}$, express x in terms of the logarithms of a and b .
- 343 1960_01_AA_46 Systems: Quadratic Linear
The graphs of $y = mx - 1$ and $(x - 2)^2 + (y + 3)^2 = 25$ are drawn on the same set of axes. If the graph of the straight line passes through the center of the circle, find the value of m .
- 344 1960_01_AA_47 Quadratics: Find Vertex Given Equation
If $P(x,y)$ is a point of the graph of $y = -x^2 + 4x + 1$, the maximum value of y is
(1) 1 (2) 2 (3) 5 (4) 4
- 345 1960_01_AA_48 Probability: Mutually Exclusive Events
The probability that Tom will hit a target is $\frac{3}{5}$. The probability that Tom will *not* hit the target is
(1) $\frac{5}{8}$ (2) $\frac{5}{3}$ (3) $\frac{2}{5}$ (4) $\frac{3}{8}$
- 346 1960_01_AA_49 Rate, Time and Distance
A man went on a trip of m miles traveling by a train whose average speed was r miles per hour. He returned by a plane whose average speed was three times that of the train. If the return trip was also a distance of m miles and the total traveling time for the round trip was 8 hours, express m in terms of r .
- 347 1960_01_AA_50 Systems: Writing
A man engages in a shooting contest. Each time he hits the target he receives 10 cents and each time he misses, he pays 5 cents. If after 20 shots the man has lost 10 cents, how many times did he hit the target?
- 348 1960_01_AA_51 Volume
An open box is to be made from a sheet of tin 12 inches square by cutting equal squares from the four corners and bending up the sides. If x represents the side of the square to be cut out, express the volume of the box in terms of x .
- 349 1960_01_AA_52 Equations: Literal
Given the formulas $S = \frac{1}{2}gt^2$ and $V = gt$ where g is a constant. Express S as a function of V .
- 350 1960_01_AA_53 Trigonometry: Polar Form
Find to the *nearest degree* the amplitude of $2 + 5i$.
* This question is based on an optional topic in the syllabus.
- 351 1960_01_AA_54 Trigonometry: Polar Form
Express $4(\cos 150^\circ + i \sin 150^\circ)$ in $a + bi$ form.
* This question is based on an optional topic in the syllabus.
- 352 1960_01_AA_55 Trigonometry: Polar Form
Express *one* of the roots of $x^3 + 8 = 0$ in polar form.
* This question is based on an optional topic in the syllabus.

AAR - Advanced Arithmetic (1900-1909)

- 1 1900_01_AAR_01 Definitions: Arithmetic
Define *five* of the following: *integer, radix, bullion, proceeds, evolution, ad valorem duty, usury*.
- 2 1900_01_AAR_02 Conversions
Change 200,332 in the quinary scale to an equivalent number in the decimal scale and prove the work.
- 3 1900_01_AAR_03 Conversions
Reduce to a common fraction .39285714
- 4 1900_01_AAR_04 Mensuration
How was the length of the meter originally determined? State a) *three* countries in which the metric system is used commercially, b) the advantages of the metric system.
- 5 1900_01_AAR_05 Volume
How many kilograms of water are required to fill a tank 2 meters deep whose base is a regular hexagon .4 meters on each side?
- 6 1900_01_AAR_06 Solid Geometry: Spheres
A sphere of lead 6 inches in diameter is melted and cast into a cylinder 4 inches in diameter; find the cylinder's height.
- 7 1900_01_AAR_07 Longitude
When it is 8 p.m. at Manila, longitude 121° east, what time is it at Washington, longitude $77^\circ 2' 28''$ west?
- 8 1900_01_AAR_08_09 Radicals: N-Roots
Extract the cube root of 47 to *three* decimal places. Give a clear geometric explanation of the method used.
- 9 1900_01_AAR_10 Ratio
A, B, and C form a partnership. A invests his capital for 8 months and receives $\frac{1}{3}$ of the profits; B invests his capital for 12 months; C invests \$4,000 for 6 months and receives $\frac{1}{6}$ of the profits. Find the capital invested by A and B.
- 10 1900_01_AAR_11 Profit and Loss
On Nov. 1, 1899 a speculator buys stock whose par value is \$20,000 at $109\frac{5}{8}$; on Jan. 19, 1900 he sells the stock at $111\frac{1}{4}$. Find his gain or loss, if brokerage is $\frac{1}{8}\%$ and money worth 6%.
- 11 1900_01_AAR_12 Profit and Loss
A merchant buys goods listed at \$2500, getting successive trade discounts of 20, 10, and 5; he sells the goods at 20% above the cost price, taking in payment a note at 60 days without interest; he then gets the note discounted at 6% and pays his bill. Find his entire gain.
- 12 1900_01_AAR_13 Profit and Loss
A New York clothier buys 200 cases of goods in London at ££25 a case, exchange being at $4.87\frac{3}{4}$; the freight charges are \$3.50 a case and the duty is 30% ad valorem. Find the per cent of gain if the goods are sold at \$175 a case.
- 13 1900_01_AAR_14 Notes and Interest
Jan. 1 a merchant buys goods on credit as follows: \$250 due in 2 months, \$400 due in 3 months, \$375 due in 4 months; find the equated time of payment.
- 14 1900_01_AAR_15 Notes and Interest
A person deposits \$100 a year in a savings bank that pays 4% interest compounded annually; how much money stands to his credit immediately after the fifth deposit?

- 15 1900_06_AAR_01 Mensuration
State the relations between the unit of length, the unit of capacity and the unit of weight in the metric system. Show the advantages of this system because of these relations.
- 16 1900_06_AAR_02 Conversions
Convert 423,501 to an equivalent number in the senary scale.
- 17 1900_06_AAR_03_04 Radicals: Square Roots
In extracting square root, show why a) the number is separated into periods of two figures each. b) twice the root already found is used as a trial divisor, c) the trial figure of the root is added to the trial divisor.
- 18 1900_06_AAR_05 Arithmetic Operations
Simplify $\frac{2}{3} \times 1.36 - 2.111 + 3.1253$
- 19 1900_06_AAR_06 Factors: Greatest Common
Find a) the greatest fraction that will be exactly contained in $\frac{12}{25}$ and $\frac{16}{35}$, b) the least fraction that will exactly contain $\frac{12}{25}$ and $\frac{16}{35}$.
- 20 1900_06_AAR_07 Solid Geometry: Spheres
A sphere 4 inches in diameter weighs 9 lbs.; find the weight of a cone of the same material whose base is 8 inches in diameter and whose altitude is 15 inches.
- 21 1900_06_AAR_08 Proportions
Find the candle-power of a lamp that, at a distance of 15 feet, gives the same intensity of light as a lamp of 16 candle-power at a distance of 12 feet.
- 22 1900_06_AAR_09 Percent
From a 10 gallon cask containing 7 gallons of wine and 3 of water 4 gallons are drawn and the cask refilled with water; what is the per cent of wine in the resulting mixture?
- 23 1900_06_AAR_10 Notes and Interest
Compare the six per cent method of computing interest with the method of computing exact interest. Show which method is usually more favorable to the borrower.
- 24 1900_06_AAR_11 Brokerage and Commission
A speculator buys through a stock-broker 50 shares of O&W at $23\frac{1}{2}$, depositing \$5 a share as margin; at the end of one month the stock is sold at $24\frac{7}{8}$. If brokerage is $\frac{1}{8}\%$ in each case and the speculator pays interest at 6% on the balance of purchase price, how much is due the speculator?
- 25 1900_06_AAR_12 Longitude
When it was 1 a.m. January 1, 1900 at San Francisco, longitude $122^\circ 25'$ west, what was the day and the hour at Yokohama, longitude $139^\circ 40'$ east?
- 26 1900_06_AAR_13 Progressions: Geometric
Consider the decimal .333 etc. as a descending geometric series, and find its exact value expressed as a common fraction.
- 27 1900_06_AAR_14 Radicals: N-Roots
Extract the cube root of 2461 to two decimal places.
- 28 1900_06_AAR_15 Definitions: Arithmetic
Define *arithmetic progression*, *annuity*, *commercial paper*, *involution*, *quinary scale*.
- 29 1909_01_AAR_01 Arithmetic: Division
Show, without dividing, whether or not 36,432 is divisible by 8, 9, 11, 15.
- 30 1909_01_AAR_02 Order of Operations
Find the value of
a. $73.2 \div 10 - 2 \div (0.5 + 1.50) + 3.125 \div (1.75 - 0.5)$
b. $\left(\frac{3}{4} \times \frac{12}{22} \times 8\frac{1}{4} \right) \div \left(3\frac{1}{11} \times \frac{1}{27} \times 5\frac{1}{2} \right)$

- 31 1909_01_AAR_03 Fractions
From $2\frac{1}{2}$ subtract $1\frac{3}{4}$ and give a full explanation of each step in the process.
- 32 1909_01_AAR_04 Notes and Interest
Explain in detail the 6% method of computing interest. Is interest computed by the 6% method greater or less than exact interest? Explain why.
- 33 1909_01_AAR_05 Brokerage and Commission
If New York and New Haven R.R. sells at $180\frac{1}{8}$ and pays $7\frac{1}{2}\%$ and West Shore sells at $108\frac{3}{4}$ and pays $4\frac{1}{2}\%$, which is the better investment?
- 34 1909_01_AAR_06 Volume
Water is 770 times as heavy as air and iron is 7.68 times as heavy as water; how many cubic meters of air will it take to weigh as much as 1 cubic decimeter of iron?
- 35 1909_01_AAR_07 Longitude
Explain the relation between longitude and time. When it is noon at Greenwich what is the longitude of that place at which is (a) 6 p.m., (b) 3 a.m., (c) 40 min. 15 sec. after 9 p.m.?
- 36 1909_01_AAR_08 Progressions: Arithmetic
Derive the formulas for the last term and the sum of n terms of an arithmetical series, the first term and the common difference being given.
- 37 1909_01_AAR_09 Proportions
Solve the following by proportion: If \$350 at 5% simple interest for 1 year and 6 months produces \$26.25 interest, how long will it take \$240 to produce \$16 at 4%?
- 38 1909_01_AAR_10 Solid Geometry: Prisms and Cylinders
A cylindrical vessel 14 inches high holds 2 cubic feet of water; what is the diameter of its base?
- 39 1909_01_AAR_11 Volume
The contents of a cubic wooden packing case is $42\frac{7}{8}$ cubic feet; how many board feet are there in the six sides of this case?
- 40 1909_01_AAR_12 Mensuration
If a cubic foot of water weights $62\frac{1}{2}$ lb what is the pressure per square inch at the bottom of a standpipe 40 feet high?
- 41 1909_06_AAR_01 Proofs: Algebraic
Prove that the difference of the squares of any two-consecutive odd numbers is a multiple of 4. [Illustration will not be accepted as proof.]
- 42 1909_06_AAR_02 Fractions
Find the sum of $\frac{2}{3}$ and $\frac{4}{5}$. Write a full explanation of the process.
- 43 1909_06_AAR_03 Proportions
If $\frac{1}{2}$ of an article costs \$1.80, what will $\frac{5}{6}$ of it cost? Give complete written analysis.
- 44 1909_06_AAR_04 Proportions
A man agreed to work for a farmer a year and to receive as wages \$320 and a cow; at the end of nine months he was discharged and given \$238 and the cow. Find the value of the cow. Give written analysis.
- 45 1909_06_AAR_05 Systems: Writing
At an election 510 votes were cast for two candidates; $\frac{2}{3}$ of the votes for one candidate equaled $\frac{3}{4}$ of the votes for the other. Find the number of votes each received.
- 46 1909_06_AAR_06 Notes and Interest
Find the proceeds of a six months note for \$200 with interest at 4%, dated March 15, 1909, discounted at a bank today at 6%.

- 47 1909_06_AAR_07 Profit and Loss
What must a man ask for a house that cost him \$7600 in order that he may reduce the asking price 5% and still gain 15% on the cost?
- 48 1909_06_AAR_08 Notes and Interest
Find the price of a $3\frac{1}{8}\%$ bond that shall be as good an investment as a $4\frac{1}{2}\%$ bond at $107\frac{1}{8}$.
- 49 1909_06_AAR_09 Volume
The specific gravity of sea water is 1.053; a rectangular vessel 15 cm deep and 10 cm wide contains 4Kg of sea water. Find the length of the vessel.
- 50 1909_06_AAR_10 Solid Geometry: Prisms and Cylinders
A cylindric cistern 10 feet in diameter is 9 feet deep; find the number of gallons of water it will contain.

AL - The Algebra Curriculum (1890 - 1900)

- 1 1890_01_AL_01 Definitions: Algebra
Explain the difference between similar and dissimilar terms and give an example of each.
- 2 1890_01_AL_02 Definitions: Algebra
Explain the difference between arithmetical subtraction and algebraic subtraction, and give an example of each.
- 3 1890_01_AL_03 Polynomials: Multiplication and Division of
Simplify the follow expression:
$$(x + y)(x^3 - y^3) \left[x^2 - y(x - y) \right]$$
- 4 1890_01_AL_04 Factors: Prime
Find the prime factors of each of the following:
 $2x^8 + 16x^7 + 32x^6$; $x^2 - 10x + 21$; $a^5 - b^5$.
- 5 1890_01_AL_05 Definitions: Algebra
Define equation; transposition; elimination; quadratic equation. What is meant by the degree of an equation?
- 6 1890_01_AL_06 Equations: Simple with Fractional Expressions
Solve $\frac{x}{a} + \frac{x}{b} + \frac{x}{c} = d$.
- 7 1890_01_AL_07 Systems: Linear
Solve, using elimination by comparison:
 $5x - 12y = 7$
 $10x - 9y = 4$
- 8 1890_01_AL_08 Equations and Expressions: Modeling
What number is that which being multiplied by 7 gives a product as much greater than 20 as the number itself is less than twenty?
- 9 1890_01_AL_09 Systems: Other Nonlinear
What fraction is that which becomes $\frac{1}{2}$ when its numerator is increased by 1 and its denominator diminished by 1; but which becomes $\frac{1}{3}$ when its numerator is doubled and its denominator increased by 5? (Give statement without solution).
- 10 1890_01_AL_10 Binomial Expansions
Expand $(a + b)^5$ and give the principle by which the coefficients and exponents of the successive terms are determined.
- 11 1890_01_AL_11 Radicals: N-Roots
Find the cube root of $x^6 - 3x^5 + 5x^3 - 3x - 1$
- 12 1890_01_AL_12 Equations: Forming Quadratics from Roots
Form the quadratic equation whose roots are -5 and +7.
- 13 1890_01_AL_13 Radicals: Operations with
Simplify $\sqrt{5} \times \sqrt[3]{2} \times \sqrt[4]{4}$
- 14 1890_01_AL_14 Systems: Other Nonlinear
 $x^2 + y^2 = 25$
 $x + y = 5$
- 15 1890_01_AL_15 Systems: Other Nonlinear
An excursion party had \$2.00 to pay, but before the bill was paid 10 of the party went away, and those that remained had each to pay 10 cents more: find how many were in the party at first.
- 16 1890_03_AL_01 Definitions: Algebra
Distinguish between an algebraic number and an algebraic expression, and give an example of each.
- 17 1890_03_AL_02 Arithmetic: Multiplication
Deduce the rule for treatment of signs in multiplication in algebra.

- 18 1890_03_AL_03 Polynomials: Addition and Subtraction of
Simplify
 $6x - (3z - 2y) - (2x - 3y - 4z) - (z - 7x - 5y)$.
- 19 1890_03_AL_04 Polynomials: Addition and Subtraction of
Collect in parenthesis the coefficients of x in
 $ab^2 + cd^2x + abcdx + a^2b + c^2dx + bcd$.
- 20 1890_03_AL_05 Factors: Prime
Find the prime factors of each of the following:
 $x^4 - 81$; $x^4 - (x - 6)^2$.
- 21 1890_03_AL_06 Definitions: Algebra
What is the difference between an identical equation and an equation of condition? Give an example of the former.
- 22 1890_03_AL_07 Definitions: Algebra
Show whether or not the following is a quadratic equation: $x^4 + 7x^3 = 8$.
- 23 1890_03_AL_08 Systems: Other Nonlinear
Solve the following:
a. $(a - x)(b - x) = x^2$
b. $\frac{3}{x} + \frac{8}{y} = 3$
 $\frac{15}{x} - \frac{4}{y} = 4$
- 24 1890_03_AL_09 Rationals: Solving
Divide 46 into two parts such that the sum of the quotients obtained by dividing one part by 7 and the other part by 3 may be equal to 10.
- 25 1890_03_AL_10 Systems: Other Nonlinear
There is a number consisting of two digits such that the number is equal to three times the sum of its digits and if it be multiplied by three, the result will be equal to the square of the sum of its digits. (Give statement only).
- 26 1890_03_AL_11 Binomial Expansions
Expand $(3m - n^2)^4$ and explain how the coefficients are obtained.
- 27 1890_03_AL_12 Radicals: N-Roots
Find the fourth root of
 $16x^4 - 96x^3y + 216x^2y^2 + 81y^4$.
- 28 1890_03_AL_13 Equations: Forming Quadratics from Roots
Form the quadratic equation whose roots are $-\frac{2}{3}$ and $-\frac{3}{2}$.
- 29 1890_03_AL_14 Radicals: Operations with
Simplify $\sqrt{27ab^2} + \sqrt{75a^3} + (a - 3b)\sqrt{3a}$.
- 30 1890_03_AL_15 Systems: Other Nonlinear
Solve $x^2 - y^2 = -65$
 $x^2 + xy + y^2 = 13$
- 31 1890_03_AL_16 Systems: Other Nonlinear
A certain company agreed to build a vessel for \$6,300; but, two of their number having died, the rest had each to advance \$200 more than they otherwise would have done. Of how many persons did the company consist at first.
- 32 1900_01_AL_01 Order of Operations
Simplify $x - \left[2a + 3x - \left\{ a \left(2x + 3a - \overline{a + x} \right) \right\} \right]$
- 33 1900_01_AL_02 Fractions: Complex
Simplify $\frac{\frac{a^2 + b^2}{b} - a}{\frac{1}{b} - \frac{1}{a}} \times \frac{a^2 - b^2}{a^2 + b^2}$

- 34 1900_01_AL_03 Polynomials: Factoring
Factor $ab^2 - ab, a^6 - a^4 - a^2 + 1, y^8 + y^4 + \frac{1}{4},$
 $\frac{c^2}{d^2} + \frac{2c}{d} - 3, x^8 + x^4 + 1.$
- 35 1900_01_AL_04 Systems: Other Nonlinear
Solve $\begin{cases} ax + by = c \\ bx - ay = d \end{cases}$
- 36 1900_01_AL_05 Quadratics: $a > 1$
Solve $3x^2 - 7x - \frac{1}{4} = 1$
- 37 1900_01_AL_06 Factors: Greatest Common
Find the greatest common divisor (highest common factor) of $3x^2 - 2x - 21$ and $3x^3 - 3x^2 - 63x + 135.$
- 38 1900_01_AL_07 Definitions: Algebra
Define *five* of the following: *power, homogenous terms, axiom, radical, surd, index, integer.*
- 39 1900_01_AL_08 Notes and Interest
A sum of money at simple interest amounts in 8 months to \$260 and in 20 months to \$275; find the principal and the rate of interest.
- 40 1900_01_AL_09 Exponents: Operations with
Divide $x^2 - y^2$ by $x^{\frac{1}{2}} - y^{\frac{1}{2}}$
- 41 1900_01_AL_10 Binomial Expansions
Expand by the binomial theorem $\left(a^2 - \frac{b}{2}\right)^6$
- 42 1900_01_AL_11 Radicals: N-Roots
Extract the cube root of
 $x^3 - 3x^2 + 9x - 13 + \frac{18}{x} - \frac{12}{x^2} + \frac{8}{x^3}$

- 43 1900_01_AL_12 Radicals: Simplifying
Simplify $\frac{d}{a-b} \sqrt{\frac{a^2c^8 - 2abc^2 + b^3c^4}{d^2}};$
 $\frac{y^4}{10} \sqrt{\frac{75a^2b^4x}{2y^3}}; \frac{x}{y} \sqrt{\frac{y^?}{x^?}}$
Note: This question is unreadable from the photograph.
- 44 1900_01_AL_13 Systems: Other Nonlinear
Solve $\begin{cases} x + y = 1 \\ x^2 + y^2 = 61 \end{cases}$
- 45 1900_01_AL_14 Radicals: Solving
Solve $\sqrt{x^5 - a^2x} = \sqrt[4]{x^4 + b^4x^2}$
- 46 1900_01_AL_15 Systems: Other Nonlinear
The square of the sum of two numbers exceeds the sum of their squares by 240, and the difference of their squares exceeds the square of their difference by 112; find the numbers.
- 47 1900_03_AL_01 Fractions: Complex
Simplify $\frac{\frac{a^2}{y} + \frac{y^2}{a}}{\frac{1}{a^2} - \frac{1}{ay} + \frac{1}{y^2}}$
- 48 1900_03_AL_02 Fractions: Complex
Divide $\frac{1}{x^3} + 1 + x^2$ by $\frac{1}{x^2} - \frac{1}{x} + 1$
- 49 1900_03_AL_03 Polynomials: Factoring
Factor $a^5 + b^{10}, 21 - 4c - c^2, x^4 + \frac{x^2}{2} + \frac{1}{16},$
 $a^6 + b^4 + a^3b^2, y^2 - 1$
- 50 1900_03_AL_04 Systems: Other Nonlinear
Solve $\begin{cases} by - ax = 2b \\ \frac{x}{b} + \frac{y}{a} = \frac{2}{b} \end{cases}$

- 51 1900_03_AL_05 Quadratics: $a > 1$
Solve $6x^2 - x - 2 = 0$
- 52 1900_03_AL_06 Factors: Greatest Common
Find the greatest common divisor (highest common factor) of $4x^2 + x - 1$ and $6x^3 + x^2 - 1$.
- 53 1900_03_AL_07 Rate, Time and Distance
A man rowing on a river whose rate of flow is 2 miles an hour finds that it takes him three times as long to row a mile up stream as to row a mile down stream; find his rate of rowing in still water.
- 54 1900_03_AL_08 Radicals: Square Roots
Extract the square root of
 $\frac{9}{4}x^4 - x^3 + 15\frac{1}{9}x^2 - \frac{10}{8}x + 25$
- 55 1900_03_AL_09 Binomial Expansions
Expand by the binomial theorem $\left(2a^2 - \frac{b^2}{3}\right)^7$
- 56 1900_03_AL_10 Radicals: Simplifying
Simplify $\sqrt[4]{\frac{81}{1296}a^{20}b^8c^{12}}$, $\frac{x^{n-1}y^{n+1}}{x^{n+1}y^{n-1}}$,
 $\sqrt{8y} - \sqrt{50y^2} + y^2\sqrt{\frac{2x^2}{y^2}}$
- 57 1900_03_AL_11 Radicals: Solving
Solve $\sqrt{x+a^2} - \sqrt{x-a^2} = \sqrt{2b}$
- 58 1900_03_AL_12_13 Systems: Other Nonlinear
Solve $\begin{cases} x^2 + y^2 = 61 \\ x^2 - xy = 6 \end{cases}$
- 59 1900_03_AL_14_15 Systems: Other Nonlinear
The perimeter of a rectangle is 92 feet and its diagonal is 34 feet; find the area of the rectangle.
- 60 1900_06_AL_01 Fractions: Complex
Simplify $\left\{\frac{1-x}{1-x+x^{-1}}\right\} \left\{x^2+1 \div \left(\frac{\frac{1}{x}-x}{\frac{1}{x}}\right)\right\}$
- 61 1900_06_AL_02 Polynomials: Multiplication and Division of
Divide $1 - a^2 - 6ax - 8x^2$ by $1 - a - 2x$
- 62 1900_06_AL_03 Polynomials: Factoring
Factor $x^2 + x + 30$, $64 - y^2$, $a^{12} + 1$, $\frac{x^2}{4} - xy + y^2$,
 $a^6 - 5a^3b^2 + b^4$
- 63 1900_06_AL_04 Systems: Three Variables
Solve $\begin{cases} 2x + y - 3z = -5 \\ x + 3y = 7 \\ 2x - 5y = -4 \end{cases}$
- 64 1900_06_AL_05 Quadratics: $a > 1$
Solve $8x^2 - 2x - 3 = 0$
- 65 1900_06_AL_06 Definitions: Algebra
Define *five* of the following: *factor, reciprocal, surd, involution, root, simultanwous equations, similar terms.*
- 66 1900_06_AL_07 Systems: Writing
The age of the elder of two boys is twice that of the younger; three years ago it was three times that of the younger. Find the age of each.
- 67 1900_06_AL_08 Exponents: Operations with
Multiply $2x - x^{\frac{1}{3}} + x^{-\frac{2}{3}}$ by $x^{\frac{1}{3}} - x^{-1} + x^{-\frac{2}{3}}$
- 68 1900_06_AL_09 Radicals: N-Roots
Find the cube root of
 $8x^6 - 12x^5 - 30x^4 + 35x^3 + 45x^2 - 27x - 27$

- 69 1900_06_AL_10 Binomial Expansions
Write out by the binomial theorem the first *four* terms of $\left(\frac{x^2}{2} - 4y\right)^7$, giving all the work for finding the coefficients.

- 70 1900_06_AL_11 Polynomials: Factoring
Reduce to its lowest terms $\frac{x^2 - 13x + 12}{x^4 + 3x^2 + 12x - 16}$

- 71 1900_06_AL_12 Radicals: Simplifying
Simplify $\frac{\sqrt{x^2 - 1} + \sqrt{x^2 + 1}}{\sqrt{x^2 + 1} - \sqrt{x^2 - 1}}, \frac{b}{a^8} \sqrt[3]{\frac{a^{3a+3}}{b^3}},$
 $\frac{\sqrt{a^2 - b^2}}{\sqrt{(a - b)^2}}$

- 72 1900_06_AL_13 Radicals: Solving
Solve $\sqrt{x+1} + \sqrt{x} = \frac{2}{\sqrt{x}}$

- 73 1900_06_AL_14 Systems: Other Nonlinear
Solve $\begin{cases} x^2 + y^2 = 9 \\ x^2y = 6 - xy^2 \end{cases}$

- 74 1900_06_AL_15 Systems: Other Nonlinear
A number is composed of two digits the difference of whose squares is 20; if the digits are interchanged the resulting number is 18 less than the original number. Find the number.

AR - The Arithmetic Curriculum (1866-1880)

- 1 1866_11_AR_01 Arithmetic: Numeration
Write in figures each of the following numbers, add them, and express in words (or numerate) their sum: fifty-six thousand, and fourteen thousandths; nineteen, and nineteen hundredths; fifty-seven, and forty-eight ten-thousandths; twenty-three thousand five, and four-tenths, and fourteenth millionths.
- 2 1866_11_AR_02 Fractions
What is the difference between $3\frac{3}{4}$ plus $7\frac{5}{9}$ and 4 plus $2\frac{3}{4}$?
- 3 1866_11_AR_03 Arithmetic: Multiplication
In multiplying by more than one figure, where is the first figure in each partial product written, and why is it so written?
- 4 1866_11_AR_04 Arithmetic: Division
If the divisor is 19, the quotient 37, and the remainder 11, what is the dividend?
- 5 1866_11_AR_05 Arithmetic: Division
What is the quotient of 65bu. 1pk. 3qt. divided by 12?
- 6 1866_11_AR_06 Conversions
Which one of the fundamental operations (or ground rules) of arithmetic is employed in reduction ascending?
- 7 1866_11_AR_07 Mensuration
In exchanging gold dust for cotton, by what weight would each be weighed?
- 8 1866_11_AR_08 Numbers: Prime and Composite
Which is the largest prime number below 100?
- 9 1866_11_AR_09 Conversions
How many weeks in 8,568,456 minutes?
- 10 1866_11_AR_10 Definitions: Arithmetic
To what *term* in division does the *value* of a common fraction correspond?
- 11 1866_11_AR_11 Fractions
What is the product of a fraction multiplied by its denominator? Give an example.
- 12 1866_11_AR_12 Decimals
What is the rule for the multiplication of decimals?
- 13 1866_11_AR_13 Conversions
How is a common fraction reduced to the decimal form? Give an example.
- 14 1866_11_AR_14 Ratio
What is *ratio* and how may it be expressed? Illustrate by one or more examples.
- 15 1866_11_AR_15 Cost
If 27 T. 3 qr. 15 lb. of coal cost \$217.83, what will 119 T. 1 qr. 10 lb. cost?
- 16 1866_11_AR_16 Cost
Find the cost of the several articles, and the amount of the following bill:
To 16750 feet of boards at \$12.50 per M.,
" 1750 " " 24.00 "
" 3500 " " 25.00 "
-
- Received Payment, \$
SAMUEL PALMER
- 17 1866_11_AR_17 Radicals: N-Roots
What is the length of the side of a cubicle box which contains 389017 solid inches?

- 18 1866_11_AR_18 Notes and Interest
What is the present worth of the following note discounted at bank, and when will it become due?
- \$100 UTICA, October 11, 1866
Ninety days from date, for value received, I promise to pay to the order of John Smith, one hundred dollars, at the Albany City National Bank.
JOHN BROWN
- Note: This question was presented to examinees on November 8, 1866.*
- 19 1866_11_AR_19 Exponents: Operations with
Involve $\frac{5}{8}$ to the 7th power.
- 20 1866_11_AR_20 Radicals: Square Roots
What is the square root of .0043046721?
- 21 1866_11_AR_21 Cost
Sold $9\frac{1}{2}$ cwt. of sugar at $\$8\frac{1}{4}$ per cwt., and thereby lost 12 per cent.: how much was the whole cost?
- 22 1866_11_AR_22 Valuation
A person owned $\frac{5}{8}$ of a mine and sold $\frac{3}{4}$ of his interest for \$1,710: what was the value of the entire mine?
- 23 1866_11_AR_23 Longitude
When it is 2 h. 36' A.M. at the Cape of Good Hope, in longitude $18^{\circ} 24'$ east, what is the time at Cape Horn, in longitude $67^{\circ} 21'$ west?
- 24 1866_11_AR_24 Cost
What is the cost of 17 T. 18 cwt. 1 qr. 17 lb. of potash at \$53.80 per ton?
- 25 1870_02_AR_01 Arithmetic: Multiplication
Multiply twenty-nine million two thousand nine hundred and nine, by four hundred and four thousand.
- 26 1870_02_AR_02 Arithmetic: Division
Divide 478656785178 by 56789.
- 27 1870_02_AR_03 Arithmetic: Division
Prove that the quotient of 478656785178 divided by 56789 is $8428688\frac{22346}{56789}$
- 28 1870_02_AR_04 Cost
A gem weighing 2oz. 18 pwt. 12 gr. Was sold for \$1.87 per grain: what was the sum paid.
- 29 1870_02_AR_05 Longitude
Venus is at a certain time $3^{\circ} S. 18^{\circ} 45' 15''$ east of the sun; Mars, $7^{\circ} S. 15^{\circ} 36' 18''$ east of Venus; Jupiter $5^{\circ} S. 21^{\circ} 38' 27''$ east of Mars: how far is Jupiter east of the sun?
- 30 1870_02_AR_06 Arithmetic: Division
What is the least common multiple (or dividend) of 3, 4, 5, 6, 7, and 8?
- 31 1870_02_AR_07 Fractions
What is $\frac{7}{8}$ of $\frac{9}{11}$ of $\frac{3}{5}$ of $\frac{4}{7}$ expressed in lowest terms?
- 32 1870_02_AR_08 Fractions
Add $\frac{1}{9}$ of $\frac{2}{3}$ to $\frac{1}{5}$ of $\frac{7}{10}$.
- 33 1870_02_AR_09 Fractions
Divide $81\frac{1}{7}$ by $9\frac{1}{5}$.
- 34 1870_02_AR_10 Arithmetic: Division
What is the greatest common divisor of $\frac{3}{4}$, 5-6, and 1 1-8?
- 35 1870_02_AR_11 Arithmetic: Multiplication
Multiply eighty-seven thousandths by fifteen millionths.
- 36 1870_02_AR_12 Conversions
What decimal fraction is equivalent to $\frac{7}{16}$?

- 37 1870_02_AR_13 Conversions
Reduce 6 fur. 8 rd. to the decimal of a mile.
- 38 1870_02_AR_14 Conversions
What is the value of .815625 of a pound Troy expressed in oz. pwt. and gr.?
- 39 1870_02_AR_15 Profit and Loss
If \$800 gain \$32 in 8 mo., what is the rate per cent?
- 40 1870_02_AR_16 Proportion
If a man travels 117 miles in 15 days, employing only 9 hours a day, how far would he go in 20 days, travelling 12 hours a day?
- 41 1870_02_AR_17 Radicals: Square Roots
What is the square root of 9754.60423716?
- 42 1870_02_AR_18 Progressions: Arithmetic
If the extremes are 11 and 74, and the common difference 7, what is the sum of the series?
- 43 1870_02_AR_19 Profit and Loss
A man having \$10,000, lost 15 per cent. Of it; what sum had he left?
- 44 1870_02_AR_20 Notes and Interest
What is the interest of \$850 for 1 year 7 mo. 18 days, at 7 per cent?
- 45 1870_02_AR_21 Notes and Interest
How long must \$165 be on interest at 6 percent to gain \$14.85?
- 46 1870_02_AR_22 Notes and Interest
What is the present worth of a note for \$875.35, payable in 7 mo. and 15 days, discounted at bank at 7 per cent?
- 47 1870_02_AR_23 Proportions
If 29 lb. of butter will purchase 40 lb. of cheese, how many pounds of butter will buy 79 lb. of cheese?
- 48 1870_06_AR_01 Arithmetic: Numeration
Numerate, read or express in words 8096392702.
- 49 1870_06_AR_02 Arithmetic: Addition
Find the sum of
91784
794380
400084
5631
79840
957001
849987
451786
4670
501
- 50 1870_06_AR_03 Arithmetic: Subtraction
 $2579584239456 - 249187654116 = ?$
- 51 1870_06_AR_04 Arithmetic: Multiplication
Multiply four hundred and sixty-two thousand six hundred and nine by itself.
- 52 1870_06_AR_05 Arithmetic: Division
Divide 1521808704 by 6503456.
- 53 1870_06_AR_06 Arithmetic: Division
If the remainder is 17, the quotient 610, and the dividend 45767, what is the divisor?
- 54 1870_06_AR_07 Factors: Prime
Resolve 7498 into its prime factors.
- 55 1870_06_AR_08 Factors: Greatest Common
Find the greatest common divisor of 285 and 465.
- 56 1870_06_AR_09 Factors: Least Common Multiples
What is the least common multiple, or dividend, of 16, 40, 96, and 105?
- 57 1870_06_AR_10 Conversions
In 4 da. 4 hr. 45 min., how many seconds?
- 58 1870_06_AR_11 Factors: Least Common Multiples
Reduce $\frac{1}{2}, \frac{1}{3}, \frac{1}{4}, \frac{1}{5}, \frac{1}{6}, \frac{1}{7}, \frac{1}{8}, \frac{1}{9}$ to equivalent fractions having the least common denominator.

- 59 1870_06_AR_12 Conversions
Reduce 4 oz. 6 pwt. 9 $\frac{3}{5}$ gr. to the fraction of a pound.
- 60 1870_06_AR_13 Polygons: Area of
How many sq. ft. in the four side walls of a room 16 $\frac{1}{2}$ ft. long, 15 ft. wide, and 9 ft. high?
- 61 1870_06_AR_14 Fractions
The product of three numbers $\frac{4}{7}$; two of the numbers are $2\frac{1}{2}$ and $\frac{7}{9}$: what is the third?
- 62 1870_06_AR_15 Arithmetic: Addition
Add together 423 ten-millionths, 63 thousandths, 25 hundredths, 4 tenths, and 56 ten-thousandths.
- 63 1870_06_AR_16 Cost
What cost 5 T. 17 cwt. 20 lb. of hay, at \$30.50 per ton?
- 64 1870_06_AR_17 Conversions
Reduce 10 oz. 18 pwt. 9 gr. to the decimal of a pound Troy.
- 65 1870_06_AR_18 Arithmetic: Division
Divide 0.01654144 by 0.0018.
- 66 1870_06_AR_19 Percent
One acre of corn yields 80 bushels, another acre 20 per cent. more; how many bushels does the second acre yield?
- 67 1870_06_AR_20 Notes and Interest
What is the amount of \$794 for four years and 4 months, at 7 per cent?
- 68 1870_06_AR_21 Notes and Interest
What is the bank discount of \$800 for 8 mo. at 6 per cent?
- 69 1870_06_AR_22 Cost
If $\frac{3}{16}$ of a ship cost £273 2s. 6d., what will $\frac{5}{22}$ cost?
- 70 1870_06_AR_23 Proportions
If \$200 gain \$12 in one year, what will \$400 gain in 9 months?
- 71 1870_06_AR_24 Radicals: Square Roots
Find the square root of $4\frac{21}{25}$.
- 72 1870_11_AR_01 Arithmetic: Numeration
Write in figures each of the following numbers, add them, and express in words (or numerate) their sum: fifty-six thousand, and fourteen thousandths; nineteen, and nineteen hundredths; fifty-seven, and forty-eight ten-thousandths; twenty-three thousand five, and four-tenths, and fourteenth millionths.
- 73 1870_11_AR_02 Fractions
What is the difference between $3\frac{3}{4}$ plus $7\frac{5}{9}$ and 4 plus $2\frac{3}{4}$?
- 74 1870_11_AR_03 Arithmetic: Multiplication
In multiplying by more than one figure, where is the first figure in each partial product written, and why is it so written?
- 75 1870_11_AR_04 Arithmetic: Division
If the divisor is 19, the quotient 37, and the remainder 11, what is the dividend?
- 76 1870_11_AR_05 Conversions
What is the quotient of 65bu. 1pk. 3qt. divided by 12?
- 77 1870_11_AR_06 Conversions
Which one of the fundamental operations (or ground rules) of arithmetic is employed in reduction ascending?

78 1870_11_AR_07 Mensuration
In exchanging gold dust for cotton, by what weight would each be weighed?

79 1870_11_AR_08 Numbers: Prime and Composite
Which is the largest prime number below 100?

80 1870_11_AR_09 Conversions
How many weeks in 8,568,456 minutes?

81 1870_11_AR_10 Fractions
To what *term* in division does the *value* of a common fraction correspond?

82 1870_11_AR_11 Fractions
What is the product of a fraction multiplied by its denominator? Give an example.

83 1870_11_AR_12 Decimals
What is the rule for the multiplication of decimals?

84 1870_11_AR_13 Conversions
How is a common fraction reduced to the decimal form? Give an example.

85 1870_11_AR_14 Ratio
What is *ratio* and how may it be expressed? Illustrate by one or more examples.

86 1870_11_AR_15 Cost
If 27 T. 3 qr. 15 lb. of coal cost \$217.83, what will 119 T. 1 qr. 10 lb. cost?

87 1870_11_AR_16 Bills and Receipts
Find the cost of the several articles, and the amount of the following bill:
To 16750 feet of boards at \$12.50 per M.,
" 1750 " " 24.00 "
" 3500 " " 25.00 "

_____ Received Payment, \$
SAMUEL PALMER

88 1870_11_AR_17 Radicals: N-Roots
What is the length of the side of a cubicle box which contains 389017 solid inches?

89 1870_11_AR_18 Notes and Interest
What is the present worth of the following note discounted at bank, and when will it become due?

\$100 UTICA, October 11, 1870
Ninety days from date, for value received, I promise to pay to the order of John Smith, one hundred dollars, at the Albany City National Bank.
JOHN BROWN

Note: This question was presented to examinees on November 11, 1870.

90 1870_11_AR_19 Exponents: Operations with
Involve $\frac{5}{8}$ to the 7th power.

91 1870_11_AR_20 Radicals: Square Roots
What is the square root of .0043046721?

92 1870_11_AR_21 Cost
Sold $9\frac{1}{2}$ cwt. of sugar at \$8 $\frac{1}{4}$ per cwt., and thereby lost 12 per cent.: how much was the whole cost?

93 1870_11_AR_22 Valuation
A person owned $\frac{5}{8}$ of a mine and sold $\frac{3}{4}$ of his interest for \$1,710: what was the value of the entire mine?

94 1870_11_AR_23 Longitude
When it is 2 h. 36' A.M. at the Cape of Good Hope, in longitude 18° 24' east, what is the time at Cape Horn, in latitude 67° 21' west?

95 1870_11_AR_24 Cost
What is the cost of 17 T. 18 cwt. 1 qr. 17 lb. of potash at \$53.80 per ton?

- 96 1880_02_AR_01 Arithmetic: Division
The quotient of one number divided by another is 37, the divisor 245, and the remainder 230; what is the dividend?
- 97 1880_02_AR_02 Rate, Time and Distance
Two men started from different places, distant 189 miles, and traveled toward each other; one goes 4 miles, and the other 5 miles an hour; in how many hours will they meet?
- 98 1880_02_AR_03 Cost
A merchant sold 18 barrels of pork, each weighing 200 pounds, at 12 cts. 5 mills a pound; what did he receive?
- 99 1880_02_AR_04 Conversions
Suppose a certain township is 6 miles long and $4\frac{1}{2}$ miles wide, how many lots of land of 90 acres each does it contain?
- 100 1880_02_AR_05 Factors: Prime
What are the prime factors of 1800?
- 101 1880_02_AR_06 Factors: Greatest Common
Find the greatest common divisor of 1426, 322, and 598.
- 102 1880_02_AR_07 Factors: Least Common Multiples
What is the least common multiple of 9, 17, 6, and 27?
- 103 1880_02_AR_08 Fractions
Add $21\frac{4}{7}$, $32\frac{3}{8}$, and $47\frac{5}{14}$.
- 104 1880_02_AR_09 Fraction Madness
Reduce $\frac{18 \div \frac{1}{5}}{9 \times \frac{1}{4}}$ to its simplest form.
- 105 1880_02_AR_10 Decimals
How many times is .12 of 12 contained in .24 of 72?
- 106 1880_02_AR_11 Cost
How many pounds of coffee, at $33\frac{1}{3}$ cents per pound, can be bought for \$14.50?
- 107 1880_02_AR_12 Cost
What is the cost of 2684 bricks, at \$8.50 per M?
- 108 1880_02_AR_13 Conversions
Required the number of pounds in a hogs head of sugar, weighing 18 cwt. 3qr. 14 lb.
- 109 1880_02_AR_14 Conversions
Reduce $\frac{5}{19}$ of a ton to integers of lower denominations.
- 110 1880_02_AR_15 Profit and Loss
Sold a quantity of merchandise that cost \$1670, at a loss of 3%: for what amount did I sell it?
- 111 1880_02_AR_16 Percent
A house was sold, at an advance of 5% on the cost, for \$13,000: what was the cost?
- 112 1880_02_AR_17 Notes and Interest
What is the interest of \$475, for 3 years, at 5% simple interest?
- 113 1880_02_AR_18 Notes and Interest
Required the amount of \$1350, from January 12, 1880, to September 19, 1881, at 9% simple interest.
- 114 1880_02_AR_19 Notes and Interest
What sum of money at 5% simple interest will yield \$275.40 in 8 years and 4 months?
- 115 1880_02_AR_20 Notes and Interest
In what time will \$3750 amount to \$4541.25 at 6% per annum?
- 116 1880_02_AR_21 Notes and Interest
What is the present worth of a debt of \$1650, due 8 months hence, without interest, money being worth 6%.

- 117 1880_02_AR_22 Notes and Interest
What is the difference between true and bank discount on \$1000, for 63 days, at 6%?
- 118 1880_02_AR_23 Profit and Loss
Sold flour at \$10.45 per barrel, and thereby lost 5% of the cost: what was the cost per barrel?
- 119 1880_02_AR_24 Proportions
Suppose a railroad train to run at the rate of 20 miles in 50 minutes, in what time will it run 275 miles?
- 120 1880_02_AR_25 Proportions
What will be the wages of 9 men for 11 days, if the wages of 6 men for 14 days be \$84?
- 121 1880_02_AR_26 Radicals: Square Roots
Find the square root of 149.4, correct to three decimal places.
- 122 1880_02_AR_27 Radicals: N-Roots
Required the cube root of 1860867.
- 123 1880_06(a)_AR_01 Definitions: Arithmetic
What are the fundamental rules of Arithmetic? Why are they so called?
- 124 1880_06(a)_AR_02 Proportions
If a scholar's expenses are 90 dollars for board, 30 dollars for clothes, 12 dollars for tuition, 5 dollars for books and 7 dollars for incidentals, what would be the expenses of 27 boys at the same rate?
- 125 1880_06(a)_AR_03 Arithmetic Operations
If 256 be multiplied by 25, the product diminished by 625, and the remainder divided by 35, what will be the quotient?
- 126 1880_06(a)_AR_04 Definitions: Arithmetic
- 127 1880_06(a)_AR_05 Fractions
Subtract $120\frac{9}{37}$ from $450\frac{1}{2}$.
- 128 1880_06(a)_AR_06 Fractions: Complex
 $14\frac{2}{7}$ less $\frac{\frac{1}{2} \text{ of } 8\frac{2}{5}}{14\frac{7}{10}}$ is $\frac{2}{3}$ of $\frac{7}{9}$ of what number?
- 129 1880_06(a)_AR_07 Conversions
Reduce .9375 to a common fraction.
- 130 1880_06(a)_AR_08 Decimals
How many times will .5 of .175 be contained in .25 of $17\frac{1}{2}$.
- 131 1880_06(a)_AR_09 Cost
How much must be paid for lathing and plastering overhead a room 35 feet long and 20 feet wide, at 26 cents a square yard?
- 132 1880_06(a)_AR_10 Conversions
Reduce 150 sheets of paper to the decimal of a ream.
- 133 1880_06(a)_AR_11 Percent
A farmer having 760 sheep, kept 25 per cent of them, and sold the remainder. How many did he sell?
- 134 1880_06(a)_AR_12 Brokerage and Commissions
What is Commission?
What is Brokerage?
- 135 1880_06(a)_AR_13 Brokerage and Commission
An auctioneer sold a house for \$3284, and the furniture for \$2,176.50; what did his fees amount to at $2\frac{1}{4}$ per cent?
- 136 1880_06(a)_AR_14 Profit and Loss
A man purchased \$6275 stock in Pennsylvania Coal Company, and sold the same at a discount of 12 per cent: what was his loss?

- 137 1880_06(a)_AR_15 Profit and Loss
If $12\frac{1}{2}$ hundred weight of sugar cost \$140, how must it be sold to gain 25%?
- 138 1880_06(a)_AR_16 Valuation
What will it cost to insure a factory valued at \$21,000 at $\frac{4}{5}$ per cent; and the machinery valued at \$15,400, at $\frac{5}{8}$ per cent?
- 139 1880_06(a)_AR_17 Notes and Interest
What is the interest on \$76.50 for 2 years, 2 months, at 5 per cent?
- 140 1880_06(a)_AR_18 Notes and Interest
Required the amount of \$387.20, from January 1 to Oct. 20, 1879, at 6%.
- 141 1880_06(a)_AR_19 Notes and Interest
What will \$450 amount to in 1 year, at 6% compound interest, payable quarterly?
- 142 1880_06(a)_AR_20 Notes and Interest
What is the present worth of \$180, payable in 3 years, 4 months, discounting at 6 per cent?
- 143 1880_06(a)_AR_21 Notes and Interest
Wishing to borrow \$500 at bank, for what sum must my note be drawn, at 30 days, to obtain the required amount, discount being at 6%?
- 144 1880_06(a)_AR_22 Notes and Interest
At what per cent. must \$1,000 be loaned for 3 years, 3 months, 20 days, to gain \$183.18?
- 145 1880_06(a)_AR_23 Notes and Interest
How long must \$204 be on interest at 6% to amount to \$217.09?
- 146 1880_06(a)_AR_24 Proportions
If a staff 3 ft. 8 in. long cast a shadow 1 ft. 6 in., what is the height of a steeple that casts a shadow 75 ft. at the same time? (Solve by proportion.)
- 147 1880_06(a)_AR_25 Radicals: Square Roots
Extract the square root of $\frac{7056}{9216}$
- 148 1880_06(a)_AR_26 Radicals: N-Roots
The pedestal of a certain monument is a cube of granite, containing 373248 solid inches: what is the length of one of its sides?
- 149 1880_06(b)_AR_01 Arithmetic: Numeration
Express in words: 5000000750001.
- 150 1880_06(b)_AR_02 Arithmetic: Division
If the product of two numbers is 346712, and one of the factors is 76, what is the other factor?
- 151 1880_06(b)_AR_03 Definitions: Arithmetic
- 152 1880_06(b)_AR_04 Factors: Least Common Multiples
Find the least common multiple of 4, 14, 28, and 98.
- 153 1880_06(b)_AR_05 Fraction Madness
The product of 3 numbers is $\frac{6}{7}$: two of the numbers are $2\frac{1}{2}$ and $\frac{7}{9}$: what is the third?
- 154 1880_06(b)_AR_06 Arithmetic: Addition
What is the sum of six millionths, four ten-thousandths, 19 hundredth-thousandths, sixteen hundredths, and four-tenths?
- 155 1880_06(b)_AR_07 Conversions
Reduce $\frac{\frac{5}{8} \text{ of } 16.125}{4\frac{7}{8}}$ to a decimal fraction.

- 156 1880_06(b)_AR_08 Bills and Receipts
 Make a receipted bill of the following articles as if sold to John Smith by yourself:
 16 lbs. of tea, at \$.85 per lb.
 28 " " coffee, at \$.25 $\frac{1}{2}$ per lb.
 15 yards of linen, at \$.66 per yard.
-
- 157 1880_06(b)_AR_09 Conversions
 How many acres are there in 250 city lots, each of which is 25 feet by 100?
- 158 1880_06(b)_AR_10 Arithmetic: Addition
 Add 96 bu. 3 pk. 2 qt. 1 pt., 46 bu. 3pk. 1 qt. 1 pt., 2 pk. 1 qt., and 23 bu. 3pk. 4qt. 1pt.
- 159 1880_06(b)_AR_11 Longitude
 By the chronometer, it is 4hr. 58 min. $4\frac{9}{15}$ sec., P.M., at Greenwich, when it is 12M. at New York; what is the longitude of New York?
- 160 1880_06(b)_AR_12 Proportions
 How many pounds of thread will it require to make 60 yd. of 3 qr. wide, if 7 lb. make 14 yd. 6 qr. wide? (Solve by double rule of three).
- 161 1880_06(b)_AR_13 Percent
 What is the difference between $5\frac{1}{2}$ per cent. of \$800, and $6\frac{1}{2}$ per cent. of \$1050?
- 162 1880_06(b)_AR_14 Profit and Loss
 If I sell a piano, which cost \$275, for \$315, what is the rate per cent. of gain?
- 163 1880_06(b)_AR_15 Percent
 What amount of government stock can I buy for \$15525, when it sells at $3\frac{1}{2}$ per cent. premium?
- 164 1880_06(b)_AR_16 Notes and Interest
 What is the simple interest of \$3750.87, for 2 years and 9 months, at 8 per cent.?
- 165 1880_06(b)_AR_17 Notes and Interest
 The interest of \$3675, for 3 years, is \$771.75: what is the rate?
- 166 1880_06(b)_AR_18 Notes and Interest
 What is the *amount*, at compound interest, of \$250, for two years, at 8 per cent.?
- 167 1880_06(b)_AR_19 Notes and Interest
 What is the bank discount of a note of \$1000, payable in 60 days, at 6 per cent. interest?
- 168 1880_06(b)_AR_20 Ratio
 A man who has only \$50, owes \$75 to A, \$150 to B, and \$100 to C: what should he pay to each?
- 169 1880_06(b)_AR_21 Exponents: Operations with
 Find the 4th power of 16.
- 170 1880_06(b)_AR_22 Radicals: Square Roots
 What is the square root of 26883881?
- 171 1880_06(b)_AR_23 Volume
 How many small cubes, of 3 inches on a side, can be sawed out of a cube 2 feet on a side, if nothing is lost in sawing?
- 172 1880_06(b)_AR_24 Volume
 How many bricks, 8 inches long and 4 inches wide, will pave a yard that is 100 feet by 50 feet?
- 173 1880_06(b)_AR_25 Fraction Madness
 There was a company of soldiers, of whom $\frac{1}{4}$ were on guard, $\frac{1}{6}$ were preparing dinner, and the remainder, 55 men, were drilling; how many were there in all?

- 174 1880_06(b)_AR_26 Proportions
A wall of 700 yards in length, was to be built, in 29 days; 12 men were employed on it for 11 days, and only complete 220 yards; how many men must be added, to complete the wall in the required time?
- 175 1880_06(b)_AR_27 Triangles: Pythagoras
If a house is 50 feet wide; and the post which supports the ridge-pole is 12 feet high, what will be the length of the rafters?
- 176 1880_11_AR_01 Arithmetic: Addition
Copy and add:
\$ 5.67
23.21
6.78
92.14
1.23
3.78
61.37
9.00
1.07
7.16
6.78
1.78
223.06
5.61
4.45
4.56
7.89
3.07
4.56
- 177 1880_11_AR_02 Arithmetic: Subtraction
From 100200300400500600 take
908070605040302
- 178 1880_11_AR_03 Valuation
What is the value of 17 chests of tea, each containing 59 lbs., at \$0.07 per lb.?
- 179 1880_11_AR_04 Mensuration
For what is Troy weight used?
- 180 1880_11_AR_05 Mensuration
Give the table of Troy weight.
- 181 1880_11_AR_06 Conversions
In 56 m. 7 fur. 37 rd. 13 ft. 9 in. how many inches?
- 182 1880_11_AR_07 Conversions
How many cords in a pile of wood 15 ft. long, 4ft. wide, and $6\frac{1}{2}$ ft. high?
- 183 1880_11_AR_08 Conversions
John Quincy Adams was born July 11, 1767, and died February 23, 1848. To what age did he live?
- 184 1880_11_AR_09 Cost
At £280 5s. $9\frac{1}{2}$ d. for 97 tons of led, what is the cost per ton?
- 185 1880_11_AR_10 Fractions
Find by cancellation, the quotient of $8 \times 5 \times 3 \times 16 \times 28$ divided by $10 \times 4 \times 12 \times 4 \times 7$.
- 186 1880_11_AR_11 Factors: Least Common Multiples
Find the least common multiple or dividend of 9, 8, 12, 18, 24, 36, and 72.
- 187 1880_11_AR_12 Factors: Least Common Multiples
Reduce $\frac{3}{4}$, $\frac{4}{5}$, $\frac{5}{6}$, $\frac{7}{8}$ to the least common denominator.
- 188 1880_11_AR_13 Volume
How many cubic feet in 10 boxes, each $7\frac{3}{4}$ ft. long, $1\frac{3}{4}$ ft. wide, and $1\frac{1}{4}$ ft. high?
- 189 1880_11_AR_14 Valuation
If $\frac{9}{16}$ of a saw-mill are worth \$631.89, what are $\frac{5}{14}$ of it worth?
- 190 1880_11_AR_15 Arithmetic: Multiplication
Multiply eighty-seven thousandths by fifteen millionths.

- 191 1880_11_AR_16 Conversions
What is the value of .965625 of a mile, in integers of lower denominations?
- 192 1880_11_AR_17 Percent
What is $\frac{7}{8}$ per cent of \$1,728?
- 193 1880_11_AR_18 Notes and Interest
I have John Smith's note for \$144, dated July 25, 1879, payable on demand; how much will be due me, at 6 per cent, simple interest, March 9, 1882?
- 194 1880_11_AR_19 Notes and Interest
What is the amount of \$100 for 3 months, the interest to be added each month, at 6%.
- 195 1880_11_AR_20 Notes and Interest
What is the present worth of \$477.71, due 4 years hence, discounted 6 per cent.
- 196 1880_11_AR_21 Notes and Interest
For what sum must a note at bank be made, payable in 3 months, at 6 per cent discount, to obtain \$300 at the present time?
- 197 1880_11_AR_22 Profit and Loss
If I sell wood at \$7.20 per cord, and gain 30 per cent, what did it cost me per cord?
- 198 1880_11_AR_23 Proportions
If 5 men can harvest a field in 12 hours, how many hours would it require if 4 more men were employed? Solved by Rule of Three (Proportion.)
- 199 1880_11_AR_24 Proportions
If 15 oxen and 20 horses eat 6 tons of hay in 8 weeks, how much will 12 oxen and 28 horses require in 21 weeks? Solve by Double Rule of Three (Compound Proportion.)
- 200 1880_11_AR_25 Radicals: Square Roots
Find the square root of 9754.4376.
- 201 1880_11_AR_26 Radicals: N-Roots
What must be the depth of a cubical cistern that will hold 3048.625 cubic feet of water?
- 202 1880_11_AR_27 Polygons: Area of
How many tiles 8 in. square will cover a floor 18 ft. long and 12 ft. wide?

AR - The Arithmetic Curriculum (1890)

- 203 1890_01_AR_01 Arithmetic: Place Value
Explain the difference between the simple value of a figure and its local value.
- 204 1890_01_AR_02 Arithmetic: Multiplication
How may the correctness of multiplication be proved and why is this a proof?
- 205 1890_01_AR_03 Arithmetic: Addition
Copy the following numbers and find their sum:
25684
3579
26
8002
704
92076
18430
257
79460
10
12895
8205
70382
99669
47169
7280
455
22895
75000
8
276
8836
32940
6666
75834
- 206 1890_01_AR_04 Cost
Bought three tubs of butter weighing $25\frac{7}{16}$, $29\frac{3}{4}$, and $27\frac{1}{8}$ pounds. The empty tubs weighed $5\frac{3}{16}$, $5\frac{3}{4}$, and $5\frac{7}{8}$ pounds. How much did the butter cost at $24\frac{3}{4}$ cents a pound?
- 207 1890_01_AR_05 Cost
Find the cost of each of the following:
5 gals. 3 qts. 1 pt. of vinegar at 20 cents a gallon
10 acres, 50 sq. rods of land at \$48 an acre
- 208 1890_01_AR_06 Conversions
Find in tons the weight of the water in a full tank the capacity of which is 100 barrels ($62\frac{1}{2}$ lbs. in a cubic foot).
- 209 1890_01_AR_07 Mensuration
Write the table of linear measure.
- 210 1890_01_AR_08 Bills and Receipts
James Jones buys of John Wilson for cash Jan. 1, 1890, 5 gals. Vinegar at \$.20; 27 lbs. sugar at 10 cents; 5 lbs. oat meal at 5 cents. Make out a bill of the above and receipt it for Wilson.
- 211 1890_01_AR_09 Notes and Interest
Find the amount of \$2,560 for 2 yrs. 7 mos. 22 days at 5%.

- 212 1890_01_AR_10 Profit and Loss
A house worth \$1,600 rents for \$9 per month and the owner pays \$36 a year taxes; what rate per cent does it pay the owner?
- 213 1890_01_AR_11 Notes and Interest
A certain $4\frac{1}{2}\%$ stock sells at 77. How much annual income will be produced by \$385 invested in it?
- 214 1890_01_AR_12 Notes and Interest
Explain the difference between true discount and bank discount.
- 215 1890_01_AR_13 Notes and Interest
Find the proceeds, bank discount and date of maturity of a note for \$2,000 at 90 days at 5%, dated and discounted July 1, 1889.
- 216 1890_01_AR_14 Valuation
If \$75 premium be paid for insuring $\frac{3}{5}$ of a store at $1\frac{1}{4}\%$, find the value of the store.
- 217 1890_01_AR_15 Rate
It is necessary to raise a tax of \$3,200 on an assessed valuation of \$180,000. The poll tax is \$140. Find the rate and A's tax on \$5,000.
- 218 1890_01_AR_16 Radicals: Square Roots
Find the square root of 4057.69.
- 219 1890_01_AR_17 Conversions
If slates average 4 mm in thickness, find the number of slates in a pile 3 dm high.
- 220 1890_03_AR_a_01 Arithmetic: Place Value
In a number what is the effect upon the value of a figure if it be removed one place to the right? What if removed one place to the left?
- 221 1890_03_AR_a_02 Numbers: Prime and Composite
Explain the difference between a prime number and a composite number.
- 222 1890_03_AR_a_03 Arithmetic: Division
When the divisor is 10, 100, or 1000, give the shortest method of division. Give an example.
- 223 1890_03_AR_a_04 Profit and Loss
If 59 books cost \$43.07 for how much must 23 of them be sold to gain \$1.84 on those sold?
- 224 1890_03_AR_a_05 Profit and Loss
If $18\frac{3}{4}$ yards of ribbon at $13\frac{1}{2}$ cents a yard are made into badges $\frac{1}{8}$ of a yard long, and the badges are sold at $12\frac{1}{2}$ cents each, how much is gained?
- 225 1890_03_AR_a_06 Cost
How much will 2 rods, 3 yds., 2 ft. of fence cost at \$12 a rod?
- 226 1890_03_AR_a_07 Circles: Center, Radius and Circumference
The circumference of one wheel of a bicycle is 55 inches, and of the other is 21 inches. The latter will revolve how many more times than the former in going 15 miles?
- 227 1890_03_AR_a_08 Bills and Receipts
William Thomas buys of Jacob Smith, March 1, 1890, giving his note for \$50 and cash for the balance, 15 pairs of boots at \$4.25; 37 pairs slippers at \$1.75; 2 doz. pairs slippers at \$9 a dozen. Make a bill of the above and receipt it for Smith.
- 228 1890_03_AR_a_09 Notes and Interest
Find the amount of a note for \$500 at 7% given Jan. 1, 1875, paid June 15, 1879.

- 229 1890_03_AR_a_10 Notes and Interest
What sum at $3\frac{1}{2}$ per cent for six years will produce \$28.87 $\frac{1}{2}$ simple interest?
- 230 1890_03_AR_a_11 Profit and Loss
If \$175 be gained by selling a house for \$1425, how much per cent would be gained by selling it for \$1600?
- 231 1890_03_AR_a_12 Notes and Interest
What annual income will be produced by \$13,000 invested in a $3\frac{1}{2}$ stock at 91.
- 232 1890_03_AR_a_13 Notes and Interest
Find the date of maturity and face of a note at 3 mos. At 5% dated March 2, 1890, which, discounted at bank, will give as avails \$8881.25.
- 233 1890_03_AR_a_14 Brokerage and Commission
An agent received \$25.50 commission at $2\frac{1}{2}$ per cent for selling 120 barrels of flour. At how much a barrel did he sell it and how much did he pay the owner?
- 234 1890_03_AR_a_15 Profit and Loss
A, and B, together, with a capital of \$2000 gain \$500. A takes $\frac{3}{5}$ of the gain. Find B's stock and share of gain.
- 235 1890_03_AR_a_16 Rate
A tax of \$33,250 is to be raised on property valued at \$950,000. Find the rate and A.'s tax on \$15,370.
- 236 1890_03_AR_a_17 Triangles: Pythagoras
Find in miles and hundredths the distance from one corner of a township 6 miles square to the diagonally opposite corner.
- 237 1890_03_AR_a_18 Mensuration
Give the name of the unit of capacity and the name of the unit of surface in the metric system.
- 238 1890_03_AR_b_01 Arithmetic
Define and illustrate by an example: abstract number; prime number; divisor; improper fraction.
- 239 1890_03_AR_b_02 Definitions: Arithmetic
To what terms in division do multiplier and product correspond?
- 240 1890_03_AR_b_03 Fractions: Complex
Subtract $\frac{1}{3}$ of $\frac{9}{10}$ from $\frac{8\frac{2}{3} + 2\frac{1}{4}}{4\frac{1}{5}}$.
- 241 1890_03_AR_b_04 Radicals: Square Roots
Divide 0.0144 by 4800; multiply the quotient by 6.004; and extract the square root of the product.
- 242 1890_03_AR_b_05 Conversions
How many steps of $2\frac{1}{2}$ feet each would a man take in walking a mile?
- 243 1890_03_AR_b_06 Volume
How many times can a box 6 inches long, 4 inches wide, and 4 inches deep, be filled from a bin 7 feet long, 2 feet wide, and 3 feet deep?
- 244 1890_03_AR_b_07 Cost
How much will it cost to carpet a room 12 feet wide and $13\frac{1}{2}$ feet long, with carpet $\frac{3}{4}$ yard wide at 90 cents a yard?
- 245 1890_03_AR_b_08 Volume
A bin that holds 100 bushels is 8 feet long and 4 feet wide; how deep is it?
- 246 1890_03_AR_b_09 Proportions
If a railroad train moves at the rate of 57 miles an hour, what per cent of an hour does it occupy in running one mile?

- 247 1890_03_AR_b_10 Cost
If $\frac{2}{9}$ of a yard of cloth cost \$1.40, how much will $\frac{3}{4}$ of a yard cost? (Solve by analysis and give the analysis in full.)
- 248 1890_03_AR_b_11 Profit and Loss
At what price must goods that cost \$11.20 be marked in order to abate 5 per cent and yet make 20 per cent gain?
- 249 1890_03_AR_b_12 Notes and Interest
Find the proceeds of a note for \$1,800 payable in 60 days at 6 per cent, discounted at bank.
- 250 1890_03_AR_b_13 Valuation
How much will it cost at $\frac{4}{5}$ per cent to insure a factory valued at \$21,000 for $\frac{5}{7}$ its value?
- 251 1890_03_AR_b_14 Percent
A house valued at \$8,000 rents for \$570. What per cent does it pay on the investment, if repairs and taxes cost \$130?
- 252 1890_03_AR_b_15 Profit and Loss
A, B, C hired a farm together for \$175, of which A paid \$75, B \$60, C \$40. They raised 250 bushels of wheat. How much was the share of each?
- 253 1890_03_AR_b_16 Proportions
If 18 horses eat 128 bushels of oats in 32 days, how many bushels will 12 horses eat in 64 days? (Solve by proportion.)
- 254 1890_03_AR_b_17 Exponents: Operations with
What is involution? Give an example of it.
- 255 1890_03_AR_b_18 Conversions
From 24 meters take 5 centimeters, and write the result in words.
- 256 1890_06_AR_01 Arithmetic: Division
If the remainder, dividend and quotient be given, how may the divisor be found? Give an example.
- 257 1890_06_AR_02 Cost
500 bales of cotton weighing 400 pounds each at 6 cts. a pound, were exchanged for nails at 5 cts. a pound; how many kegs of 100 pounds each were given. Solve by cancellation.
- 258 1890_06_AR_03 Proportions
If 3 horses eat 3 bushels of oats in 2 days how many horses will eat 20 bushels in 8 days? (Solve by analysis and write analysis in full).
- 259 1890_06_AR_04 Profit and Loss
If $43\frac{3}{4}$ yards of carpet cost \$26 $\frac{1}{4}$ and $\frac{2}{5}$ of the whole is sold at a gain of \$ $\frac{1}{4}$ on each yard, how much is received for what is sold?
- 260 1890_06_AR_05 Volume
How many paving stones 6 in. by 8 in. will pave a street 270 ft. by 50, and how much will it cost at 9 cents each?
- 261 1890_06_AR_06 Conversions
Two telegraph stations are 18 miles, 40 rods, 44 yards apart. If the telegraph poles between them are 8 rods apart how many poles will be needed and how much will they cost at 20 cents apiece?
- 262 1890_06_AR_07 Mensuration
Write the table for dry measure.
- 263 1890_06_AR_08 Bills and Receipts
George Thomas buys of Timothy Marsh for cash, June 1, 1890, 15 lbs butter at 25 cents; 20 lbs rice at 8 cents; 6 lbs raisins at 20 cents. Make a bill of the above and receipt it for Marsh.

- 264 1890_06_AR_09 Profit and Loss
A certain house will sell for \$5500. Is it better for the owner to rent the house for \$550 a year, paying taxes \$100 and repairs \$50 a year, or to sell the property and invest the money at $5\frac{1}{2}\%$?
- 265 1890_06_AR_10 Notes and Interest
In what time will \$1500 at 6% gain \$217.50, simple interest?
- 266 1890_06_AR_11 Profit and Loss
How many oranges bought at the rate of 20 for 25 cents must be sold for \$7, which includes a gain of 40 per cent?
- 267 1890_06_AR_12 Notes and Interest
At what price must 8% stock be bought to produce an income of $3\frac{1}{4}\%$ on the amount invested?
- 268 1890_06_AR_13 Notes and Interest
Find the date of maturity and face of a note at 4 mos. at $4\frac{1}{2}\%$ per cent, dated Dec. 2, 1889, which discounted at bank will give as proceeds \$11,814.
- 269 1890_06_AR_14 Brokerage and Commission
An agent received \$1610 with which to buy goods. He pays \$11 cartage and receives $2\frac{1}{2}\%$ per cent commission on the amount *purchased*. Find the amount *purchased*.
- 270 1890_06_AR_15 Ratio
A, B, & C hired a pasture together for \$100. A pastures 300 sheep, B 420 sheep, and C pays $\frac{1}{4}$ the rent. How much of the rent must A and B each pay, and how many sheep does C put in?
- 271 1890_06_AR_16 Triangles: Pythagoras
A pole 180 feet high casts a shadow 135 ft. long. Find the distance from the top of the pole to the end of the shadow.
- 272 1890_06_AR_17 Mensuration
Give the name of the unit of weight and the name of the unit of volume in the metric system.

AR - The Arithmetic Curriculum (1900-1940)

- 273 1900_01_AR_01 Definitions: Arithmetic
Define five of the following: *denominator, evolution, brokerage, prime factor, reciprocal, premium, endorsement.*
- 274 1900_01_AR_02 Fractions: Complex
Simplify $\frac{25}{18} \times \frac{1\frac{13}{15}}{2\frac{16}{27}} \div \frac{4.375 \div \frac{7}{4}}{5\frac{3}{4} - \frac{11}{3}}$
- 275 1900_01_AR_03 Volume
Find the weight of a bar of iron $6\frac{1}{2}$ centimeters wide, 26 millimeters thick and 40 centimeters long, iron being 7.8 times as heavy as water.
- 276 1900_01_AR_04 Factors: Greatest Common
Find the greatest common divisor (highest common factor) of 12,032 and 16,403.
- 277 1900_01_AR_05 Notes and Interest
Find the amount of \$380 at 5% simple interest from March 9, 1898 to the present date.
- 278 1900_01_AR_06 Systems: Writing
A and B together have \$70; C has twice as much as B and A has three times as much as C. How much has each?
- 279 1900_01_AR_07 Conversions
Reduce $\frac{128}{225}$, $\frac{200}{512}$, $\frac{254}{324}$ to decimals. Add these decimals and express their sum as a common fraction in its simplest form.
- 280 1900_01_AR_08 Cost
Find the cost, at 12 cents a square yard, of plastering the four walls and ceiling of a room 14 feet by 12 feet and 9 feet high, allowing 15 square yards for doors and windows.
- 281 1900_01_AR_09 Volume
Find in liters the capacity of a tank $1\frac{1}{2}$ meters deep, $4\frac{3}{4}$ meters long and $3\frac{1}{4}$ meters wide.
- 282 1900_01_AR_10 Cost
Find the cost of the following items of lumber:
3 pieces $8" \times 6" \times 12'$ at \$17 a 1000 feet
30 " $12" \times 2" \times 14'$ " 20 "
20 " $10" \times \frac{7}{8}" \times 16'$ " 25 "
- 283 1900_01_AR_11 Radicals: Square Roots
Find the square root of 43 to *three* decimal places.
- 284 1900_01_AR_12 Brokerage and Commission
An agent charged his principal \$106.35 (commission being $2\frac{1}{2}\%$) for buying 5000 bushels of wheat; the freight charges, etc. amounted to \$43.75. How much a bushel did the wheat cost the principal?
- 285 1900_01_AR_13 Brokerage and Commission
A speculator buys bonds whose par value is \$10,000 at $113\frac{3}{4}$ and sells them at $115\frac{1}{8}$; how much does he gain if brokerage is $\frac{1}{8}\%$ in each transaction?
- 286 1900_01_AR_14 Notes and Interest
Find the proceeds of a note for \$425 at 90 days when discounted at 6%.
- 287 1900_01_AR_15 Cost
Find the cost, at 75 cents a square yard, of paving a circular court whose radius is 40 feet.
- 288 1900_03_AR_01 Order of Operations
Simplify $\left[\left(14\frac{2}{7} \div \frac{15}{54} \right) - \left(6\frac{3}{8} \times \frac{32}{17} \right) \right] \times .0625$

- 289 1900_03_AR_02 Cost
Find the cost of paving a walk 140 centimeters wide and $\frac{3}{5}$ kilometer long at \$1.25 a square meter.
- 290 1900_03_AR_03 Cost
What is the value, at \$5 a cord, of a pile of wood 4 feet wide, 10 feet high and 20 yards long.
- 291 1900_03_AR_04 Bills and Receipts
Make a receipted bill of the following: William Stone buys this day of Flagg Brothers 2 barrels flour at \$5.50, 20 lbs. sugar at 5½ cents, 4 lbs. coffee at 35 cents, 5 lbs. butter at 28 cents, 2 bushels potatoes at 45 cents.
- 292 1900_03_AR_05 Notes and Interest
A note for \$350, at 5% simple interest, was given Nov, 23, 1898; find the amount of this note today.
Note: This question was asked on March 30, 1900
- 293 1900_03_AR_06 Fraction Madness
A, B and C together have \$250; B has $\frac{2}{3}$ as much as A, and C has $\frac{1}{4}$ as much as A and B together.
How much has each?
- 294 1900_03_AR_07 Volume
The interior of a rectangular tank is 2½ feet by 3 feet by 5 feet; in how many minutes will this tank be filled by a pipe that admits 18 quarts of water a minute? [1 gallon = 231 cubic inches.]
- 295 1900_03_AR_08 Profit and Loss
A merchant sold a case of goods which cost \$14.40 at 10% below the marked price, thus gaining 25% on the cost; find the marked price.
- 296 1900_03_AR_09 Conversions
Find in ounces the weight of 20 silver dollars. [Weight of 1 silver dollar = 412.5 grains.]
- 297 1900_03_AR_10 Radicals: Square Roots
Find the square root of 6,115,729.
- 298 1900_03_AR_11 Valuation
A man pays \$75 for insuring his house for $\frac{3}{4}$ its value at 1¼%; find the value of the house.
- 299 1900_03_AR_12 Brokerage and Commission
A capitalist buys U.S. 4% bonds to the amount of \$50,000 par value at 112 $\frac{3}{8}$, brokerage 1/8%; find the cost of the bonds and the rate of income on the investment.
- 300 1900_03_AR_13 Notes and Interest
On a note for \$400, at 6%, dated Jan. 12, 1899, the following payments have been made: May 22, 1899, \$200; Oct. 2, 1899, \$150. Find the amount due today.
Note: This question was asked on March 30, 1900
- 301 1900_03_AR_14 Proportions
A yardstick perpendicular to a level floor casts a shadow 18 inches long; find the height of a flagstaff which at the same time casts a shadow 70 feet.
- 302 1900_03_AR_15 Volume
Find in kilograms the weight of the water that fills a cylindrical tank 1 meter high and 60 centimeters in diameter.

303 1900_06_AR_01 Order of Operations

$$\text{Simplify } \left[\left(\frac{67}{12} + 2\frac{1}{6} - 3\frac{13}{18} \right) \div \left(\frac{29}{8} - 1\frac{2}{9} + 5\frac{47}{72} \right) \right] \times \left(.625 \times \frac{16}{25} \right)$$

- 304 1900_06_AR_02 Volume
The bottom of a rectangular tank which holds 2400 liters of water is $2\frac{1}{2}$ meters long and 120 centimeters wide; find the depth of the tank.
- 305 1900_06_AR_03 Factors: Greatest Common
Find the greatest common divisor and the least common multiple of 243, 198, and 264.
- 306 1900_06_AR_04 Profit and Loss
A grocer pays \$12 for 5 bushels of cranberries and sells them so as to gain $33\frac{1}{3}\%$; find the selling price per quart.
- 307 1900_06_AR_05 Notes and Interest
Find the amount of \$835 at $4\frac{1}{2}\%$ simple interest from October 25, 1898 to the present time.
Note: This question was asked on June 12, 1900
- 308 1900_06_AR_06 Definitions: Arithmetic
Define five of the following: *antecedent, decimal fraction, factor, interest, payee, policy, subtrahend.*
- 309 1900_06_AR_07 Notes and Interest
John Hartwell borrows this day of Charles Smith \$280, giving his note for 3 months at 5%. Write the promissory note in proper form and find its amount at maturity.
- 310 1900_06_AR_08 Volume
If 1 bushel of wheat weighs 60 lbs, what is the capacity in cubic feet of a bin which holds 1 ton of wheat? [1 bushel = 2150.42 cubic inches.]
- 311 1900_06_AR_09 Cost
Find the cost of carpeting a floor $13\frac{1}{2}$ feet by 18 feet, the carpet being $\frac{3}{4}$ of a yard wide and costing \$1.20 a yard.
- 312 1900_06_AR_10 Volume
Find the exact contents in cubic yards of a solid wall 8 feet high and 18 inches thick around a rectangular court 20 yards by 32 yards.
- 313 1900_06_AR_11 Radicals: Square Roots
Find the square root of 73 to *three* decimal places.
- 314 1900_06_AR_12 Brokerage and Commission
A person sells 200 shares of railway stock at $105\frac{1}{2}$ and invests the proceeds in mining stock at $70\frac{1}{8}$, paying $\frac{1}{8}$ brokerage in each case; how many shares of mining stock does he buy?
- 315 1900_06_AR_13 Brokerage and Commission
An agent sold 3000 bushels of oat, and, after deducting his commission of $2\frac{1}{2}\%$, sent his principal the proceeds, \$877.50; for how much a bushel were the oats sold?
- 316 1900_06_AR_14 Percent
The list price of a bill of goods is \$120; find the net cost when the successive commercial discounts are 20, 10 and 5.
- 317 1900_06_AR_15 Solid Geometry: Prisms and Cylinders
Find the number of square feet in the convex surface of a cylindrical iron chimney 30 inches in diameter and 50 feet high.
- 318 1909_01_AR_01 Definitions: Arithmetic
Define factor, radius, quotient, numerator, right angle.
- 319 1909_01_AR_02 Arithmetic: Addition
Copy and add [No credit will be given unless the sum is correct]:
68530
26982
16450
19247
36293
18964
73251
57368
46527
10339
82644
63102
38972
87654
23456

- 320 1909_01_AR_03 Proportions
If the capital of a certain stock company is \$60,000 and profits amounting to \$6300 are to be distributed among the stockholders, how much profit will there be for each \$100 of the stock?
- 321 1909_01_AR_04 Notes and Interest
A note for \$420, dated April 30, 1907, with interest at 5%, is paid in full today, January 26, 1909; find the amount required to pay both principal and interest.
- 322 1909_01_AR_05 Arithmetic Operations
a. Multiply 398.69 by 87.96
b. Divide 63,843.84 by 9.78. [*a* and *b* to have 5 credits each if results are correct.]
- 323 1909_01_AR_06 Notes and Interest
A broker borrows \$7500 in Boston at 4% and purchases a $7\frac{1}{2}$ % western mortgage; how much will he gain in 5 years?
- 324 1909_01_AR_07 Triangles: Pythagoras
A flagstaff 40 feet high casts a shadow 30 feet in length; what is the distance from the end of the shadow to the top of the pole?
- 325 1909_01_AR_08 Cost
What will be the cost of carpeting the floor of a room 22 ft by 18 ft, with carpet $\frac{3}{4}$ yd wide, at 85¢ a yd?
- 326 1909_01_AR_09 Valuation
A man insures a house, valued at \$3500, for $\frac{4}{5}$ of its value, at $\frac{3}{4}$ %; what is his loss if the house burns? What did the insurance cost him?
- 327 1909_01_AR_10 Volume
If a bin is 3 m. long, 11.5 dm. wide and 2 m. deep, how many hectoliters of grain will it contain?
- 328 1909_01_AR_11 Bills and Receipts
Make a receipted bill of the following items bought of Frank Jones by William French: 26 pounds of sugar at $5\frac{1}{2}$ cents a pound; 23 pounds of lard at $7\frac{1}{2}$ cents a pound; 5 bushels of potatoes at 78 cents a bushel; 3 gallons 2 quarts of molasses at 65 cents a gallon; 4 pounds of rice at 10 cents a pound; 8 pounds of coffee at 35 cents a pound; 3 heads of cabbage at 8 cents a head; 2 bushels 3 pecks of apples at 80 cents a bushel.
- 329 1909_01_AR_12 Fraction Madness
A man left an estate of \$150,240; he willed $\frac{1}{3}$ of it to his wife, $\frac{1}{8}$ to each of his three daughters, $\frac{1}{4}$ to his son and $\frac{1}{2}$ of the remainder to each of his two grandchildren. How much did each of the grandchildren receive? Given written analysis.
- 330 1909_06_AR_01 Conversions
A farmer had four loads of hay weighing respectively 1875 pounds, 2013 pounds, 2099 pounds, and 1283 pounds; he sold the hay at \$13 per ton. How much did he receive for it?
- 331 1909_06_AR_02 Notes and Interest
Write a promissory note and tell for what it is used.
- 332 1909_06_AR_03 Profit and Loss
A merchant bought notebooks at \$1.20 per dozen and sold them at 15¢ apiece; what per cent did he gain?
- 333 1909_06_AR_04 Arithmetic Operations
A certain man placed money in a bank as follows: January 1, \$82.55; February 3, \$98.79; February 21, \$79.89; March 2, \$82.79; May 3, \$937.49; June 1, \$329.59; July 3, \$492.89; July 29, \$193.75; August 2, \$849.76; August 15, \$593.29. He drew from the bank the following amounts: May 8, \$92.75; June 15, \$129.83; July 6, \$19.75; August 5, \$399.50; September 5, \$298.65. How much money has he still in the bank? [No credit will be given unless the answer is correct.]

- 334 1909_06_AR_05 Notes and Interest
Mr Anderson borrowed \$70 May 15, 1908, and agreed to pay it June 3, 1909, with interest at 6%. What was the total amount of his debt June 3, 1909?
- 335 1909_06_AR_06 Bills and Receipts
Make, in correct form, a receipted bill showing the following items purchased by John Smith of C. F. Adams, May 31, 1909, and paid for June 15, 1909: 10 pounds of butter at 32 cents per pound; 6 cans of corn at 16 cents per can; 1 pound of tea at 60 cents per pound; 3 dozen eggs at 35 cents per dozen.
- 336 1909_06_AR_07 Percent
A merchant bought goods listed at \$3587.50 from which the following discounts were allowed: 10%, 5% and 6%. What did the goods cost him?
- 337 1909_06_AR_08 Arithmetic Operations
Multiply 5960 by $12\frac{7}{8}$. Divide 644.4250 by .00865. [No credit will be given unless the answers are correct.]
- 338 1909_06_AR_09 Rate
How much tax must a man pay who owns a house assessed at \$3945, a store assessed at \$8750 and a factory assessed at \$29,500, if the tax rate is \$2.35 per thousand.
- 339 1909_06_AR_10 Conversions
A man owns a field 330 ft long and 132 ft deep (wide). (a) How many acres are there in the field? (b) Into how many lots 33 ft front by 132 ft deep can it be divided? (c) Draw a diagram to show the division of this field into lots.
- 340 1909_06_AR_11 Ratio
Three men, *A*, *B* and *C*, on entering into partnership invested respectively \$1800, \$2500 and \$4000. The net profits at the end of the first year amounted to \$415. How much should be the share of each?
- 341 1909_06_AR_12 Polygons and Circles: Inscribed
How much more would it cost to build a fence around a square lot whose side is 40 rods than around a circular lot whose diameter is 40 rods, if the fencing costs \$1.00 per yard?
- 342 1920_01_AR_02 Arithmetic: Addition
Copy and add the following: [5]
3.75; 81.375; .49; 7860.5; 26.625; .338; .92; 918; 54627; 83.125; 325.5; 426
- 343 1920_01_AR_03 Fractions
 $107\frac{15}{16} + 1\frac{7}{8} = ?$ [5]
- 344 1920_01_AR_04 Fractions
From the sum of $3\frac{1}{2}$, $2\frac{3}{4}$ and $7\frac{3}{8}$ subtract 3.875 [5]
- 345 1920_01_AR_05 Fractions
Multiply the sum of $2\frac{3}{4}$ and $5\frac{3}{8}$ by the difference between $7\frac{1}{4}$ and $3\frac{1}{2}$ [5]
- 346 1920_01_AR_06 Percent
A man lost 20% of his money and then lost 10% of the remainder; if he had \$3600 left, how much did he have at first? [10]
- 347 1920_01_AR_07 Profit and Loss
An automobile costing \$1125 was sold for \$1350; what was the per cent of profit? [10]
- 348 1920_01_AR_08 Volume
A cubic foot of copper weighs 552 pounds; how many ounces does 1 cubic inch of copper weigh? [10]
- 349 1920_01_AR_09 Central Tendency: Averages
The record for a herd of 24 cows showed a yield of 3240 pounds of milk per week; how much milk would be produced per week if 10 cows equally good could be added to the herd? [10]

- 350 1920_01_AR_10 Notes and Interest
Which is the better investment and how much on each \$1000 invested, 6% stock selling at 90 *or* 5% stock selling at 70? [10]
- 351 1920_01_AR_11 Solid Geometry: Prisms and Cylinders
A cylindrical tank is 3 feet long and 14 inches in diameter; how many gallons of gasoline will it hold? [$\pi = \frac{22}{7}$; one gallon contains 231 cubic inches.] [10]
- 352 1920_01_AR_12 Cost
At \$22.25 a thousand, how much will 15,875 bricks cost? [10]
- 353 1920_01_AR_13 Notes and Interest
A man owns thirteen \$500 United States $4\frac{1}{4}\%$ Liberty Bonds; how much will he receive annually in interest from these bonds? [10]
- 354 1920_01_AR_14 Brokerage and Commission
A commission merchant sold a consignment of 400 dozen eggs at 70¢ a dozen; if his commission was 5% and the charges for freight and cartage amounted to $1\frac{1}{2}$ ¢ a dozen, what amount should he remit to the shipper? [10]
- 355 1920_01_AR_15 Bills and Receipts
On October 20, 1919, James Price bought of George Kent, Chicago, Ill., the following goods:
 $5\frac{1}{2}$ yards of elastic at 16¢ a yard; $3\frac{3}{4}$ yards of gingham at 96¢ a yard; 7 yards of silk braid at 17¢ a yard; 4 sheets at \$2.40 each; 8 pillow cases at 95¢ each; 6 towels at \$1.35 each. Make out the receipted bill. [10]
- 356 1920_06_AR_02 Arithmetic: Addition
Copy and add the following: [5]
34.5; 783.2; 29.02; 300.45; 41.004; 283.15; 12.125; 10.001; .005; 1050.4; 2064
- 357 1920_06_AR_03 Proportions
If 5 tons of coal cost \$60, how much will $12\frac{1}{2}$ tons cost at the same rate? [5]
- 358 1920_06_AR_04 Fractions
What is the product of 108 and $3\frac{15}{16}$? [5]
- 359 1920_06_AR_05 Fractions
From $37\frac{7}{16}$ subtract $29\frac{1}{2}$. [5]
- 360 1920_06_AR_06 Central Tendency: Averages
On seven successive days at noon the thermometer registered 80 degrees, 76 degrees, 82 degrees, 79 degrees, 85 degrees, 90 degrees, and 88 degrees; what was the average temperature for the week? [10]
- 361 1920_06_AR_07 Cost
Find the cost of laying a concrete walk 8 rods long and $5\frac{1}{2}$ feet wide at 32¢ a square foot. [10]
- 362 1920_06_AR_08 Percent
An article is listed in a catalog at \$50; this price is subject to a 25% discount and a further discount of 10% for cash. What is the cash sale price of the article? [10]
- 363 1920_06_AR_09 Bills and Receipts
Make out a receipted bill for the following articles bought from E.C.Gray who is doing business in your home town: 4 pounds sugar @ 20¢ a pound; $1\frac{1}{2}$ pounds rice @ 16¢ a pound; $2\frac{3}{4}$ pounds butter @ 72¢ a pound; $1\frac{1}{4}$ dozen eggs @ 76¢ a dozen. [10]
- 364 1920_06_AR_10 Profit and Loss
If pencils are bought at the rate of 3 for 2 cents and sold at the rate of 2 for 3 cents, how much will the profit be on 72 pencils? [10]
- 365 1920_06_AR_11 Prisms and Cylinders
How many cubic feet of silage will a cylindrical silo 14 feet in diameter and 30 feet high hold? [10]

- 366 1920_06_AR_12 Notes and Interest
A note for \$150 which does not bear interest is discounted at a bank 30 days before it is due, the rate of discount being 6%. A suit of clothes at \$75 and an overcoat at \$45 are purchased with the proceeds. How much money remains? [10]
- 367 1920_06_AR_13 Triangles: Pythagoras
A rectangular park is 40 rods long and 30 rods wide; if A walks the length and breadth of the park and B walks from one corner direct to the diagonally opposite corner, how many rods farther does A walk than B? [10]
- 368 1920_06_AR_14 Brokerage and Commission
A commission merchant charged a farmer 8% commission for selling his produce; if he remitted to the farmer \$3910 for a sale, what was the selling price of the produce? [10]
- 369 1920_06_AR_15 Profit and Loss
A man buys a house for \$4200 and spends \$800 on repairs; he then sells it for \$5500. What is his gain per cent? [10]
- 370 1930_06_AR_01 Cost
Find the cost of 3500 envelopes at \$7.75 a thousand.
- 371 1930_06_AR_02 Notes and Interest
A battleship costs \$30,000,000. If this amount was placed at $4\frac{1}{2}\%$ simple interest, what would be the annual income?
- 372 1930_06_AR_03 Cost
Find the cost of 26 quarts of cream at \$1.10 a gallon.
- 373 1930_06_AR_04 Percent
James earned \$1.80 a day and saved 40% of it. If he worked 30 days during the summer vacation, how much did he save?
- 374 1930_06_AR_05 Percent
A 16-pound turkey weighed 12 pounds after it was roasted; find the per cent loss in weight.
- 375 1930_06_AR_06 Fractions
If there are 320 pupils in a class and $\frac{7}{8}$ were promoted, how many failed?
- 376 1930_06_AR_07 Fractions
How many pieces, each $\frac{3}{4}$ of an inch long, can be made from a bar of iron 1 foot long?
- 377 1930_06_AR_08 Cost
What is the cost of painting a kitchen floor that is 15 feet long and 12 feet wide at 35¢ a square yard?
- 378 1930_06_AR_09 Volume
Find the area of a triangular flower bed whose base is 8 feet and whose altitude is $6\frac{1}{2}$ feet.
- 379 1930_06_AR_10 Percent
What is the selling price of a bathing suit that is marked \$8.50 and sold at 15% discount?
- 380 1930_06_AR_11 Central Tendency: Averages
If Jack's scores on five arithmetic tests were 67, 72, 80, 91 and 85, what was his average score?
- 381 1930_06_AR_12 Fractions
If it costs $8\frac{1}{4}$ ¢ a mile to operate a car, what would a 1480-mile trip cost?
- 382 1930_06_AR_13 Proportions
On a road map the distance from Albany to New York, 150 miles, measures $66\frac{1}{4}$ inches; how many miles are represented by 1 inch on this map?
- 383 1930_06_AR_14 Arithmetic: Subtraction
Find the difference between 87 and 5.089
- 384 1930_06_AR_15 Arithmetic: Addition
Add \$96.79; \$42.04; \$7.98; \$14; \$31.60

- 385 1930_06_AR_16 Fractions
Add $72\frac{5}{8}$; $26\frac{3}{4}$; 185; $379\frac{1}{2}$
- 386 1930_06_AR_17 Arithmetic: Addition
Add 7 ft 3 in.; 8 ft 6 in.; 9 ft 8 in.; 2 ft 3 in.; 3 ft 5 in.
- 387 1930_06_AR_18 Fractions
 $3\frac{3}{4} - 2\frac{15}{16}$
- 388 1930_06_AR_19 Arithmetic Operations
Multiply 827 by 64 and from the product subtract 10724.
- 389 1930_06_AR_20 Arithmetic Operations
 $2.25 \times 3\frac{1}{5}$
- 390 1930_06_AR_21 Fractions
 $5\frac{5}{6} \times 6\frac{2}{3}$
- 391 1930_06_AR_22 Decimals
Multiply 56.019 by 2.93
- 392 1930_06_AR_23 Decimals
Divide 6.273 by 1.23
- 393 1930_06_AR_24 Fractions
 $7\frac{2}{9} \div 1\frac{5}{8}$
- 394 1930_06_AR_25 Proportions
 $8 : x = 12 : 168$; find x .
- 395 1930_06_AR_26 Profit and Loss
Mr Camp rents a house to Mr Eddy for \$75 a month. Mr Camp pays \$165 for taxes, \$30 for insurance and repairs and \$130 for paving assessment. How much was his net income from the property that year? [10]
- 396 1930_06_AR_27 Cost
A Girl Scout has saved \$50 and plans to go to a summer camp for a three weeks vacation. Board is \$8 a week, laundry 50 cents a week, railroad fare to camp and return \$3.30, extras \$1 a week.
a What would be the expense for a three weeks stay at camp? [8]
b How much money would the girl have left? [2]
- 397 1930_06_AR_28 Profit and Loss
A grocer bought 81 bushels of potatoes at \$1.15 a bushel and sold $\frac{2}{3}$ of them at \$.45 a peck and the remainder at \$.40 a peck. What was his profit? [10]
- 398 1930_06_AR_29 Valuation
A man owns a house worth \$6000, which is assessed for 75% of its value. What is his tax at \$26.74 per \$1000 of assessed valuation? [10]
- 399 1930_06_AR_30 Percent
A family with an income of \$2500 a year allowed $\frac{1}{5}$ of the income for rent, 25% for food, 15% for clothing, \$150 for recreation, 20% for other expenses and the rest for savings. How much money was saved? [10]
- 400 1930_06_AR_31 Notes and Interest
Find the interest at 6% on \$1970 borrowed April 9, 1928 and due July 15, 1930. [10]
- 401 1930_06_AR_32 Cost
What will it cost a man to drive a car 400 miles if his car averages 15 miles to the gallon of gasoline and 100 miles to the quart of oil? Gasoline costs 18.5¢ a gallon and oil 30¢ a quart. [10]

- 402 1930_06_AR_33 Cost
Some Boy Scouts desire to undertake a reforestation project. They find that by setting the trees 6 feet apart each way they need approximately 1200 trees an acre. They wish to set out 7800 trees. Land costs \$5 an acre. Trees cost \$4 a thousand and the expressage is 30¢ a thousand.
- a* Find the cost of the land needed for the trees. [5]
- b* Find the cost of the trees. [2]
- c* Find the express charges. [2]
- d* What is the total cost of the project?[1]
- 403 1940_01_AR_01 Decimals
Divide 3.15 by .15
- 404 1940_01_AR_02 Cost
What was the total of your mother's grocery bill if she gave the clerk a 10-dollar bill and received \$3.71 in change?
- 405 1940_01_AR_03 Percent
What per cent is represented by the fraction $\frac{1}{5}$?
- 406 1940_01_AR_04 Conversions
How many feet are there in $\frac{1}{10}$ of a mile?
- 407 1940_01_AR_05 Perimeter
If the length of a rectangle is l and its width is w , complete the formula for its perimeter: $p =$
- 408 1940_01_AR_06 Conversions
If a truck has a capacity of 10,000 pounds, how many tons will it hold?
- 409 1940_01_AR_07 Volume
Find the area of a floor 24 feet long and 20 feet wide.
- 410 1940_01_AR_08 Cost
Find the cost of 3 pounds 4 ounces of meat at 32¢ a pound.
- 411 1940_01_AR_09 Cost
At the rate of 60¢ per \$100, what is the premium on an insurance policy for \$3000?
- 412 1940_01_AR_10 Percent
A baseball team won 15 games out of 20; what per cent of the games did the team win?
- 413 1940_01_AR_11 Percent
At a sale the price of a 25-dollar bicycle is reduced 20%. What is the amount of the discount.
- 414 1940_01_AR_12 Equations: Simple
When $4x$ equals 12, what does x equal?
- 415 1940_01_AR_13 Volume
Find the volume of a bin 20 feet long, 6 feet wide and 3 feet deep.
- 416 1940_01_AR_14 Circles: Area of
Write the formula that would be used to find the area of a circle when the radius is given.
- 417 1940_01_AR_15 Conversions
The distance between two villages in Belgium is 5 kiolometers. Find the distance in miles between the two villages. [One kilometer is equal to .6 mile.]
- 418 1940_01_AR_16 Cost
The prices in Dr Morton's dental clinic are as follows: cleaning \$2, filling \$1, extraction \$2. Sue had her teeth cleaned, three teeth filled and one extracted. What was her bill?
- 419 1940_01_AR_17 Proportions
At 30 miles per hour, how long does it take to travel one mile?
- 420 1940_01_AR_18 Equations and Expressions: Modeling
Jane has n pencils. Her brother has 5 times as many. Express the number of pencils he has in terms of n .

- 421 1940_01_AR_19 Perimeter
Which is the greater distance, the perimeter or the diagonal of a square?
- 422 1940_01_AR_20 Arithmetic: Division
A boy in his shopwork was given a board 16 feet long and was asked to cut it into pieces each $1\frac{1}{2}$ feet long. How many full pieces did he get?
- 423 1940_01_AR_21 Arithmetic: Multiplication
Thirty inches of cloth will make one kitchen towel. How many yards of material are required to make 6 towels?
- 424 1940_01_AR_22 Central Tendency: Averages
In three trials in a standing broad jump a boy jumped the following distances; 5 feet 11 inches, 6 feet, 6 feet 1 inch. Find the average distance that he jumped.
- 425 1940_01_AR_23 Numbers: Comparing Real
Which of the following is greatest: 575 million dollars, 40 billion dollars, \$73,000,000?
- 426 1940_01_AR_24 Mensuration
One summer day the sun rose at 5:00 a.m. and set at 7:12 p.m. How long did it shine?
- 427 1940_01_AR_25 Proportions
If four oranges cost 10¢, what will one dozen cost?
- 428 1940_01_AR_26 Profit and Loss
Mr. Walker drove a car for nearly 15 years without an accident. During that time he paid \$28 a year for automobile liability insurance. Near the end of the 15th year he injured a man seriously. The damages amounted to \$5000, which the insurance company paid. How much did Mr. Walker save by having paid insurance for 15 years? [10]
- 429 1940_01_AR_27 Valuation
Mr. Smith owns a small house assessed at \$1200 in a community that has a tax rate of \$10 per \$1000. He enlarges and improves his house in order to accommodate summer guests and his property is then assessed at \$2500. Find the increase in his taxes. [10]
- 430 1940_01_AR_28 Cost
The four members of the Jones family took a five-day trip to the World's Fair. Find the total cost of the trip if their expenses were as follows: [10]
Gasoline – 30 gallons at 18¢ per gallon.
Oil – 4 quarts at 25¢ per quart
Hotel bill -- \$8 for the family per night for 4 nights
Meals -- \$5 for the family per day for 5 days
Admission to fairgrounds -- 50¢ each per day. (All attended all four days.)
Miscellaneous -- \$5
- 431 1940_01_AR_29 Profit and Loss
By borrowing \$152 in July to pay cash for his coal, Mr. Smith was able to get a discount of \$25 on his winter's supply. He paid interest on the loan for 6 months at the rate of 6% per year. How much did he save by borrowing the money? [10]
- 432 1940_01_AR_30 Brokerage and Commission
A salesman for a hardware company receives an annual salary of \$1800 and a commission of 10% on all sales above \$5000. If he sells goods worth \$8650 in one year, how much does he earn in all? [10]
- 433 1940_01_AR_31 Cost
There are 96 pupils in the first three grades of a school who receive a midmorning lunch of one cracker and a cup of tomato juice every day. A quart of tomato juice will serve 12 pupils and a package of graham crackers contains 32 crackers.
- How many quarts of tomato juice and how many packages of crackers will be necessary for one day? [4]
 - What will be the total cost of the lunch if tomato juice is 15¢ a quart and crackers cost 13¢ a package? [6]

- 434 1940_01_AR_32 Cost
At the end of a certain month, Mr. Brown received a bill from a power company for the electrical energy used in his house. He had used 160 kw-hr (kilowatt-hours) of energy. The rates charged for supplying electrical energy to his type of home were as follows:
The first 10 kw-hr at 10¢ a kw-hr
The next 25 kw-hr at 5¢ a kw-hr
The next 50 kw-hr at 3¢ a kw-hr
Additional energy at 2¢ a kw-hr
What was the amount of his electric light bill for the month? [10]
- 435 1940_06_AR_01 Arithmetic: Subtraction
Subtract 2 feet 8 inches from 7 feet 3 inches.
- 436 1940_06_AR_02 Proportions
When cans of tomato soup sell at 3 for 25¢, how many cans can you buy for one dollar?
- 437 1940_06_AR_03 Definitions: Arithmetic
What do we call money paid for the use of money?
- 438 1940_06_AR_04 Conversions
If 384 half-pint bottles of milk were sold in the school cafeteria in one day, how many quarts of milk were sold that day?
- 439 1940_06_AR_05 Mensuration
When Peter left home the speedometer of his car read 16,214.9 miles. When he reached Buffalo it read 16,405.2 miles. How far had he traveled?
- 440 1940_06_AR_06 Conversions
On three successive days Mary gathered 56 eggs, 48 eggs and 40 eggs. How many dozen did she gather altogether?
- 441 1940_06_AR_07 Percent
A dealer paid 54¢ for a pair of shears listed at 72¢. What was the rate of discount allowed to this dealer?
- 442 1940_06_AR_08 Proportions
How many minutes will it take Mr Ware to drive 12 miles at the rate of 30 miles an hour?
- 443 1940_06_AR_09 Proportions
If one gallon of milk weighs 8.5885 pounds, find to the nearest *hundredth* of a pound, the weight of one quart of milk.
- 444 1940_06_AR_10 Cost
Mary was promised a new summer outfit. This was what she planned to buy: a dress \$5.98, shoes \$5.00, hat \$1.19, stockings \$.79, gloves \$1.29. How much money did she need?
- 445 1940_06_AR_11 Cost
The toll charge for telephone calls between two cities is 35¢ for the first 3 minutes and 10¢ for each additional minute. At this rate what will a 6-minute call cost?
- 446 1940_06_AR_12 Arithmetic: Division
If a space of 18 inches is allowed for each person, how many persons can be seated on 5 rows of bleacher seats each 90 feet long?
- 447 1940_06_AR_13 Equations and Expressions: Using Substitution in
Using the formula $V = lwh$, find the value of V when $l=10$, $w=8$, and $h=6$.
- 448 1940_06_AR_14 Special Quadrilaterals: Rectangles and Squares
What plane geometric figure does a sheet of paper from an ordinary tablet represent?
- 449 1940_06_AR_15 Equations and Expressions: Modeling
Jane had 15 cents and lost x cents. How many cents did she have left?
- 450 1940_06_AR_16 Profit and Loss
In order to raise money for a class trip, an eighth grade class bought 500 pencils for \$14 and sold them at 5 cents each. How much money did the class make?
- 451 1940_06_AR_17 Equations: Simple
If $x + 3 = 7$, does $x = 4$, 21 or 10?

- 452 1940_06_AR_18 Profit and Loss
Jerry makes a profit of $2\frac{1}{2}\%$ on each Sunday paper that he sells. How much profit will he make on 50 Sunday papers?
- 453 1940_06_AR_19 Triangles: Equilateral
How many degrees are there in each angle of an equiangular triangle?
- 454 1940_06_AR_20 Percent
If a discount of 16% is allowed on a tennis racket that ordinarily sells for \$8, what is the sales price?
- 455 1940_06_AR_21 Numbers: Comparing Real
Which is the largest fraction, $\frac{1}{3}$, $\frac{1}{2}$, or $\frac{1}{4}$?
- 456 1940_06_AR_22 Solid Geometry: Lines and Planes in Space
Does a telephone pole usually stand in a vertical, horizontal or oblique position?
- 457 1940_06_AR_23 Polygons: Area of
A regulation baseball diamond is a square in which the distance between bases is 90 feet. What is its area?
- 458 1940_06_AR_24 Proportions
If John can save 25¢ a week, how many weeks will it take him to save \$10?
- 459 1940_06_AR_25 Proportions
On a certain house plan a line 5 inches long represents 20 feet. How many inches would represent 30 feet?
- 460 1940_06_AR_26 Profit and Loss
Henry had 58 chickens to sell. On August 15 they weighed 240 pounds and could have been sold at 23¢ a pound. He kept them until October 1 and fed them at a cost of \$5. He then sold them, a total weight of 265 pounds, at 24¢ a pound. How much did he gain or lose by keeping them? [10]
- 461 1940_06_AR_27 Profit and Loss
Mary Stevens, a stenographer, paid \$8.40 a year for hospital insurance. She had paid for nine years when she had to have an appendicitis operation. If her insurance took care of the hospital items listed below, how much did she gain by carrying the insurance for the nine years? [10]
- | | |
|----------------------------|---------|
| Operating room | \$10.00 |
| Semiprivate room 14 days @ | 3.75 |
| Dressings | 2.50 |
| Laboratory | 9.25 |
| Ambulance | 5.00 |
- 462 1940_06_AR_28 Cost
Mr Jones is planning to build a house. He has saved \$7500. The lot he wants will cost \$1975, and the carpenter has estimated that it will cost \$6300 to erect the house. Grading and other extra expenses will cost \$500.
- How much money will Mr Jones have to borrow? [6]
 - At 6%, how much interest will he have to pay per year for the money he borrows? [4]
- 463 1940_06_AR_29 Valuation
In paying income tax of 4%, an unmarried man is allowed \$1000 exemption for himself. A married man is allowed an exemption of \$2500 for himself and wife, plus \$400 for each of his children.
- How much income tax must Mr Smith, who is unmarried, pay if he receives an annual salary of \$2000? [4]
 - How much income tax must Mr Jones, who is married and has three children, pay if he receives an annual salary of \$4800? [6]
- 464 1940_06_AR_30 Rate
In a recent year the United States produced about 14,400,000 bales of cotton, which sold for \$756,000,000.
- At that rate, what was the value of a bale of cotton that year? [5]
 - There are about 500 pounds in a bale of cotton. What was the average price of a pound of cotton that year? [5]

- 465 1940_06_AR_31 Rate, Time and Distance
 Suppose you left home on a bicycle at 10:00 a.m. and rode to a village 24.5 miles away, arriving there at 3:30 p.m. If you stopped 2 hours to rest and eat lunch, what was the average speed per hour at which you traveled? [10]

- 466 1940_06_AR_32 Equations and Expressions: Modeling
- a) Select the equation that correctly expresses the relationship expressed in *each* of the following problems:
- (1) After traveling a distance of 160 miles, a man still had 80 miles to go in order to reach his destination. What was the distance he had planned to cover?
 $80d = 160$; $80 + d = 160$; $d - 160 = 80$ [2]
- (2) The area of a rectangle is 252 square inches. If the width is 14 inches, what is the length?
 $14l = 252$; $\frac{l}{14} = 252$; ; $l - 14 = 252$ [2]
- b) Solve for x *each* of the following equations:
- (1) $\frac{x}{3} - 4 = 12$ [2]
- (2) $3x + 6 = 18$ [2]
- c) Add $4a + 2b - 3a + c$ [2]

- 467 1940_06_AR_33 Cost
 John's father and mother plan to take him to New York this summer and wish to decide whether to go by train or by automobile. The round-trip railroad fare for one adult is \$14.66. John, being under 12 years of age, can travel for half fare. By automobile, the distance is 300 miles each way, and John's father estimates that it costs 5¢ a mile to drive their car.
- a) Find the cost of railroad fare for the family to New York and back. [5]
- b) Find the cost of making the trip by automobile to New York and back. [5]

- 468 1940_06_AR_34a Polygons: Area of
 Using the dimensions on the accompanying diagram, determine the following:

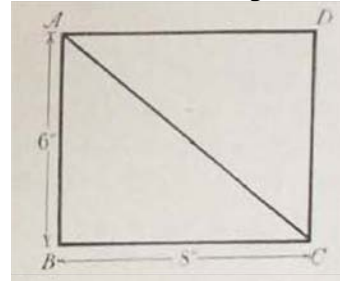

- (1) The perimeter of rectangle ABCD [1]
- (2) The area of triangle ABC [2]
- (3) The length of diagonal AC [2]
- 469 1940_06_AR_34b Solid Geometry: Prisms and Cylinders
 The accompanying diagram represents a metal can.

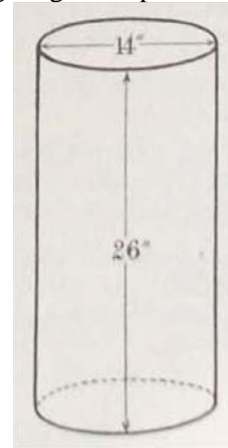

- (1) What is the name of this common geometric solid? [1]
- (2) Find the area of the base. [2]
 Find the volume of the can. [2]

BA - Business Arithmetic (1940)

- 1 1940_08_BA_01-2a Arithmetic: Addition

Add [5]

6432

7519

2964

1786

6945

1479

5306

6679

3893

2931

9887

2468

1916

2854

7693

6945

3456

7201

- 2 1940_08_BA_01-2b Notes and Interest

Find the interest on each of the following:

[5]

\$120 for 10 days at 6% =

\$600 for 3 months at 2% =

\$400 for 80 days at $4\frac{1}{2}\%$ =

\$500 for 36 days at 5% =

\$380 for 15 days at 3% =

- 3 1940_08_BA_01-2c Cost

Make the extensions: [5]

750 lb @ \$4 per C =

150 lb @ 1.50 =

640 lb @ $.37\frac{1}{2}$ =

160 lb @ $.07\frac{1}{2}$ =

480 lb @ $.16\frac{2}{3}$ =

- 4 1940_08_BA_01-2d-1 Profit and Loss

Complete the following: [5]

A typewriter was listed at \$110 and sold for \$88; the rate of discount was _____.

- 5 1940_08_BA_01-2d-2 Profit and Loss

A letter file that sold for \$40 cost \$25; the rate of profit based on the selling price was _____.

- 6 1940_08_BA_01-2d-3 Rate

The number of yards that can be bought for \$75 at \$1.25 a yard is _____.

- 7 1940_08_BA_01-2d-4 Profit and Loss

A coat that cost \$30 was sold for \$45; the rate of profit based on the cost was _____.

- 8 1940_08_BA_01-2d-5 Percent

.0075 is equivalent to _____% [Express fraction in lowest terms.]

- 9 1940_08_BA_03a Percent

What single rate of discount is equivalent to the series 20%, $12\frac{1}{2}\%$ and 5%?

- 10 1940_08_BA_03b Central Tendency: Averages

For six consecutive days a newsboy's profits were as follows: 84¢, 40¢, 75¢, 57¢, 86¢ and \$1.02. What was his average daily profit?

- 11 1940_08_BA_03c Cost

How much will a hardware dealer pay if he takes advantage of the discount on an invoice for \$500, terms $\frac{3}{10} \frac{n}{30}$.

- 12 1940_08_BA_03d Polygons: Area of

Find the area in square yards of the floor of a hall which is 12 feet long and whose width is $\frac{1}{2}$ of its length.

- 13 1940_08_BA_03e Notes and Interest
A 60-day note for \$800 is dated today and is discounted today at 6%. How much will the bank deduct for its service?
- 14 1940_08_BA_04 Profit and Loss
A man sold two houses for \$4000 each; on one he gained 10% on the cost; on the other he lost 10% on the cost. Find his net gain or loss.
- 15 1940_08_BA_05 Rate
Mr Race insured his store for \$5000 at an annual rate of 28¢ per \$100. The insurance agent told Mr Race that it would be to his advantage to insure for a longer period. The agent explained that if he took out a policy for three years, the rate would be $2\frac{1}{2}$ times the annual rate and if he insured for five years, the rate would be four times the annual rate.
a What premium did Mr. Race pay for his one-year policy?
b What premium would he have paid if he had taken a three-year policy?
c What would have been the average annual cost of a three year policy?
d What premium would he have paid if he had taken a five-year policy?
e Why was the insurance company willing to quote a cheaper rate when the insurance was taken out for more than a year?
- 16 1940_08_BA_06 Notes and Interest
On an invoice of \$3460, Martin & Company are offered three months credit or a discount of 5% for cash. Not having the ready money, they accept the credit terms. How much would they save if they borrowed the money at 6% and paid cash?
- 17 1940_08_BA_07 Rate
The assessed valuation of property in a certain city is \$18,226,098. The estimated budget expenses are \$1,337,108. Expected receipts are \$201,999 from the state and \$391,319 from license fees.
a Find the tax rate per \$1000. [Give your answer to the *nearest cent*.] [5]
b If \$227,430 of the budget was to be collected from real estate owners for school support, what was the school-tax rate in mills on a dollar? [3]
c John Lathrop had a house valued at \$5000 and assessed for $\frac{4}{5}$ of its value. What was the amount of his school tax?
- 18 1940_08_BA_08 Percent
During the years 1934-38 inclusive, 2,153,575 accidents were reported to the New York State Workmen's Compensation Division. During this period, 1,872,091 hearings were held and 816,461 cases were closed.
a Find the average number of accidents reported annually during the period. [2]
b Find the per cent of accidents on which hearings were given. [Express the result to the *nearest tenth per cent*.] [4]
c Find the per cent of cases heard that were closed. [Express the result to the *nearest hundredth per cent*.] [4]
- 19 1940_08_BA_09 Ratio
A, B, and C are partners in a business which showed a net profit of \$11,356.70. A's investment is \$12,000; B's \$18,000; and C's \$24,000. The balance of the net profit was divided equally among the partners, after each partner was paid 6% interest on his investment and \$5000 was reserved for contingencies that might arise.
a Find the share of the balance of the net profit that each partner received. [6]
b Find the total income that each partner received. [4]

20 1940_08_BA_10 Notes and Interest

A savings bank pays interest on its deposits at the rate of $1\frac{1}{2}\%$ a year and adds the interest to the balance on the first of January, April, July and October. No interest is allowed on fractional parts of a dollar. Deposits made not later than the third business day of any month draw interest from the first of the month. On January 2, 1939, James Smith deposited \$500. On April 1, he withdrew \$100. On July 1, he deposited \$75. He closed his account on October 1, 1939.

- a How much did the bank pay Mr Smith on October 1, 1939?
- b What was the amount of bank interest that he recorded on his income-tax blank?

21 1940_08_BA_11 Profit and Loss

At what price should an article that cost \$72 be marked, in order to allow a discount of 20% from the marked price, pay the agent a 10% commission for selling and make a profit of 25% on the cost of the article?

22 1940_08_BA_12 Notes and Interest

The cash price of an automobile was \$991. Harry Jordan bought the car on a deferred-payment plan which required a down payment of \$331 and 12 monthly payments of \$61.63. Mr Jordan could have borrowed the money from the bank at 5%.

- a How much would the bank have charged to lend him the balance required to buy for cash? [2]
- b What was the amount that Jordan paid for financing his purchase on the deferred-payment plan? [2]
- c Including the finance charge, how much did Jordan's car actually cost him? [2]
- d By what per cent did the amount Jordan paid exceed the cash price of the car? [4]

EA - The Elementary Algebra Curriculum (1890-1909)

- 1 1890_06_EA_01 Definitions: Algebra
Mention two important points of difference between arithmetic and algebra.
- 2 1890_06_EA_02 Equations and Expressions: Modeling
Write in algebraic symbols, x plus the square root of the binomial a square plus x square, equals the fraction, twice a square divided by the square root of the binomial a square minus x square.
- 3 1890_06_EA_03 Polynomials: Addition and Subtraction of
From $4y^2 + 4xy + x^2 - 2a(x + y) + 6\sqrt{a^2 - x^2} - 8\sqrt[3]{b^2 - y^2}$ take
 $4x^2 + 4xy + y^2 - 4a(x + y) - 10\sqrt[3]{b^2 - y^2} + 4\sqrt{a^2 - x^2}$.
- 4 1890_06_EA_04 Polynomials: Addition and Subtraction of
Explain how you obtain the algebraic sign and coefficient of the first two terms of the answer in the last example.
Note: The example referred to is:
From $4y^2 + 4xy + x^2 - 2a(x + y) + 6\sqrt{a^2 - x^2} - 8\sqrt[3]{b^2 - y^2}$ take
 $4x^2 + 4xy + y^2 - 4a(x + y) - 10\sqrt[3]{b^2 - y^2} + 4\sqrt{a^2 - x^2}$.
- 5 1890_06_EA_05 Rationals: Addition and Subtraction of
Simplify $\left(\frac{x}{x+y} + \frac{y}{x-y}\right) + \left(\frac{x}{x-y} - \frac{y}{x+y}\right)$.
- 6 1890_06_EA_06 Factors: Greatest Common
Find the greatest common divisor of $x^6 - y^6$ and $ax^3 - bx^3 - ay^3 + by^3$, and express the answer in prime factors.
- 7 1890_06_EA_07 Equations and Expressions: Modeling
What number must be subtracted from both numerator and denominator of the fraction $\frac{70}{87}$ in order that the value of the result may be $\frac{3}{4}$?
- 8 1890_06_EA_08 Systems: Other Nonlinear
Solve $\frac{x+3y}{x-y} = 8$.
 $\frac{7x-13}{3y-5} = 4$
- 9 1890_06_EA_09 Binomial Expansions
Expand $(1-2x)^5$. Give the general law of coefficients and its application to obtain the coefficients in this example.
- 10 1890_06_EA_10 Radicals: N-Roots
Find the cube root of $27x^3 - 135x^2 + 225x - 125$.
- 11 1890_06_EA_11 Radicals: Operations with
What is the value of
(1) $2\sqrt[3]{14} \times 3\sqrt[3]{4}$
(2) $\sqrt{a^2 - b^2} \div \sqrt{a-b}$
- 12 1890_06_EA_12 Systems: Other Nonlinear
Solve $3xy - 2(x+y) = 28$.
 $2xy - 3(x+y) = 2$

- 13 1890_06_EA_13 Systems: Quadratic Linear
There are two square rooms whose floors contain together 890 square feet, and the side of one floor is 4 feet longer than a side of the other floor. Required the length of a side of each floor.
- 14 1909_01_EA_01 Polynomials: Multiplication and Division of
Reduce the following fraction to lowest terms:
$$\frac{x^2 - 3x + 2}{x^3 + x^2 - 3x - 2}$$
- 15 1909_01_EA_02a Equations and Expressions: Modeling
Express algebraically: 5 times the cube of x is divided by the fraction whose numeration is 6 times the square of b and whose denominator is the square of the difference between x and twice the cube of y .
- 16 1909_01_EA_02b Arithmetic: Numeration
Express in words:
$$\frac{5(a^2 + b^2)}{(x + 2y^4)^3}$$
- 17 1909_01_EA_03 Polynomials: Factoring
Factor four of the following: $x^{2m} + 2x^m y^n + y^{2n}$;
 $x^4 - y^4$; $2x^6 - 10x^4 - 28x^2$; $ax + ay + bx + by$;
 $10x^2 + 13x - 3$
- 18 1909_01_EA_04 Systems: Writing
Find two consecutive numbers such that one seventh of the greater exceeds one ninth of the less by one.
- 19 1909_01_EA_05 Polynomials: Multiplication and Division of
Divide $1 - x^2$ by $x^2 - 1$, then substitute the quotient found for x in the following expression and reduce to the simplest form:
$$\left(2 - x - x^2 - x^3 + x^4\right) - \left(1 + x - x^2 + x^3 - x^4\right)$$
- 20 1909_01_EA_06 Radicals: Operations with
By reducing the surds to the same order, determine which is the greater, $\sqrt{3}$ or $\sqrt[3]{5}$
- 21 1909_01_EA_07 Radicals: Operations with
If $a = 0.8$, $b = 20$, $c = 5$ find the numeric value of
$$\frac{\sqrt{a} + \sqrt{b}}{\sqrt{c}}$$
- 22 1909_01_EA_08 Proportions
Prove that if four quantities are in proportion the product of the extremes is equal to the product of the means. [A numeric illustration will not be accepted as proof.]
- 23 1909_01_EA_09 Systems: Quadratic Linear
Solve
$$\begin{cases} x^2 + y^2 = 25 \\ x + y = 1 \end{cases}$$
- 24 1909_01_EA_10 Systems: Other Nonlinear
A carpenter agrees to build a fence for \$48; the owner, however, decides to shorten the length of the fence 2 rods and to pay \$2 more per rod, the fence thus costing \$60. Find the number of rods of fence and the cost per rod.
- 25 1909_01_EA_11 Systems: Other Nonlinear
The length of a rectangular lot is 4 rods greater than its width, and its area is 40 square rods; find the dimensions of the lot.
- 26 1909_01_EA_12 Systems: Other Nonlinear
The product of the square roots of two consecutive positive numbers is $2\sqrt{14}$; find the numbers.
- 27 1909_06_EA_01 Polynomials: Multiplication and Division of
Divide $6x^3 + 11x^2 - 1$ by $3x - 1 + 2x^3$
- 28 1909_06_EA_02 Factors: Prime
Find the prime factors of $1 - \frac{x^4}{4}$,
 $2a^4 - 20a^3 + 180a^2$, $a^3 + b^3$, $4x^4 + 3x^2y^2 + 9y^4$,
 $ax + 4a - 4x - 16$

- 29 1909_06_EA_03 Systems: Linear
Solve
$$\begin{cases} 3x + 8 = 4y + 2 \\ \frac{4x}{3} + \frac{y}{2} = 3 \end{cases}$$

Give an axiom justifying each step in the solution.
- 30 1909_06_EA_04 Equations and Expressions: Modeling
Find a number such that if it is added to 1, 4, 9, 16 respectively, the results will form a proportion.
- 31 1909_06_EA_05 Radicals: Solving
Solve $\sqrt{x+1} + \sqrt{x-2} = \sqrt{2x+3}$
- 32 1909_06_EA_06 Radicals: Square Roots
Find the square root of
$$\frac{a^2}{9} + \frac{2ab}{15} - \frac{2x}{3} + \frac{b^2}{25} - \frac{2b}{5} + 1$$
- 33 1909_06_EA_07 Radicals: Simplifying
Simplify three of the following: $\sqrt[3]{-125x^6}$,
 $\sqrt[5]{\frac{-y^{10}}{150x^{150}}}$, $\sqrt[3]{108r^8}$, $\sqrt[4]{\frac{4}{9}} \times \sqrt[4]{\frac{16}{27}}$,
 $\sqrt{75} - 4\sqrt{243} + 2\sqrt{108}$
- 34 1909_06_EA_08 Systems: Other Nonlinear
Solve
$$\begin{cases} x^2 + 2xy = 55 \\ 2x^2 - xy = 35 \end{cases}$$
- 35 1909_06_EA_09 Rate, Time and Distance
If the speed of a railway train should be lessened 4 miles an hour the train would be half an hour longer in going 180 miles. Find the rate of the train.
- 36 1909_06_EA_10 Systems: Other Nonlinear
If the greater of two numbers is divided by the less the quotient is 2 and the remainder is 3; the square of the greater number exceeds 6 times the square of the less by 25. Find the numbers.
- 37 1920_01_EA_01a Polynomials: Addition and Subtraction of
From $6x^2 + 8x - 2$ take $2x^2 - 3x + 5$ and check the result, letting $x = 2$ [6]
- 38 1920_01_EA_01b Polynomials: Multiplication and Division of
Divide $6x^3 + 5x^2 - 4x + 2$ by $2x + 3$ and write the result as a mixed expression. [6]
- 39 1920_01_EA_01c Polynomials: Factoring
Factor $9x^2 - y^2$
 $r^3s^2 - 4r^6s^2$
 $c^2 + 3c - 54$
 $x^2 + 6x - 16y^2 + 9$ [8]
- 40 1920_01_EA_01d Systems: Linear
Solve and check
 $5x - 4y = -43$
 $2x + 3y = 15$ [6]
- 41 1920_01_EA_01e Rationals: Solving
Solve $\frac{2x}{6} - \frac{x-2}{3} = 12 - \frac{x+4}{2} - x$ [6]
- 42 1920_01_EA_01f Rationals: Addition and Subtraction of
Express as a single fraction in its lowest terms: [6]
$$\frac{4x}{x^2 - 4} + \frac{3x - 2}{4 - x^2}$$
- 43 1920_01_EA_01g Radicals: Operations with
Multiply and simplify the results: [6]
 $(2\sqrt{3} - 3\sqrt{5})$ by $(\sqrt{3} + 2\sqrt{5})$
- 44 1920_01_EA_01h Rationals: Solving
Solve for x and check either result: [6]
$$\frac{7x}{6} = \frac{1}{2} - x^2$$
- 45 1920_01_EA_02 Equations: Literal
Solve for l in the formula $S = \frac{n}{2}(a + l)$ [10]
- 46 1920_01_EA_03 Systems: Quadratic Linear
Solve for x and y , correctly group your answers and check:
 $2x - 3y = 3$
 $x^2 - 4xy = -3$ [10]

- 47 1920_01_EA_04 Radicals: Square Roots
In the formula $h^2 = a^2 + b^2$, find the value of b to two decimal places, i.e. to the nearest hundredth, when $h = 7$ and $a = 1$ [10]
- 48 1920_01_EA_05 Systems: Writing
The difference between two numbers is 13 and their sum is 77; find the two numbers. [10]
- 49 1920_01_EA_06 Alligation
Milk is sold at 16¢ a quart and cream at 72¢ a quart; how many quarts of each will be needed to make 18 quarts of a mixture to sell for \$6.24? [10]
- 50 1920_01_EA_07a Rate, Time and Distance
If a man's rate of rowing in still water is S miles an hour and the current flows at the rate of C miles an hour, express the man's rate (1) when rowing with the current, (2) when rowing against the current. [4]
- 51 1920_01_EA_07b Consecutive Integers
An odd number is represented by $2n + 1$. Represent the next two consecutive odd numbers. [2]
- 52 1920_01_EA_07c Equations and Expressions: Modeling
If tennis balls cost r cents a dozen last year and the price has advanced 60¢ a dozen, how much will a half dozen cost at the present rate? [4]
- 53 1920_01_EA_08 Systems: Quadratic Linear
The length of a given rectangle exceeds its width by 4 yards and the area of the rectangle is 82 square yards; find the dimensions of the rectangle correct to the nearest tenth. [10]
- 54 1920_01_EA_09 Graphic Representation: Histograms and Tables
The average weight of boys at different ages beginning at 6 years and continuing to 15 years is given in the table below:
Age: 6 7 8 9 10 11 12
13 14 15
Weight (lbs): 50 53 57 62 67 72 78
85 93 105
a Make a graph of this table. [8]
b A boy, normal in every respect, weighs 87 pounds; what is his approximate age? Show how this approximation is made from the graph. [2]
- 55 1920_06_EA_01a Factors: Prime
Write the prime factors of *four* of the following:
 $a^2 - .04$ [2]
 $2Pr^2 + 2Prh$ [2]
 $4x^2 + 24x + 36$ [2]
 $12 + 16c - 3c^2$ [2]
 $r^2 - s^2 - 25 + 10s$ [2]
- 56 1920_06_EA_01b Polynomials: Multiplication and Division of
Divide $6e^2 - 13e - 4$ by $2e - 3$ and check the result, assuming that $e = 2$. Division [2], check [4]
- 57 1920_06_EA_01c Systems: Linear
Solve the following and check:
 $\frac{5x}{3} + 2y = 17$
 $2x - \frac{4y}{3} = -2$
First solution [6], second solution [2], check [2].
- 58 1920_06_EA_01d Polynomials: Multiplication and Division of
Represent as a single fraction in its lowest terms:
 $\left(\frac{6a}{a^2 - 4} + \frac{3}{2 - a} \right) \div \frac{3}{a^2 - a - 6}$
Addition [5], division [3]

- 59 1920_06_EA_01e Radicals: Simplifying
Write in simplest form *each* of the following, using a single radical in each case to express the result:

$$\sqrt{16a^2 - 48a^2b} - \sqrt{9ab^2 - 27b^2};$$

$$\sqrt[3]{24} \times \sqrt[3]{18}$$
Subtraction [5], multiplication [3]
- 60 1920_06_EA_01f Quadratics: Noninteger Solutions
Find to the *nearest* tenth the roots of

$$5 - \frac{x^2}{6} = \frac{4x}{3} \quad [10]$$
- 61 1920_06_EA_02 Equations and Expressions: Modeling
Find the number whose square diminished by 20 is equal to 8 times the number. Equation [5], solution [5]
- 62 1920_06_EA_03 Equations: Literal
In the formula $S = \frac{a}{2}(2t - 1)$
a Find the value of *t* in terms of *a* and *S*. [5]
b Find the value of *t* when *a* = 5.65, *S* = 73.45 [5]
- 63 1920_06_EA_04a Definitions: Algebra
Give the name applied to the 3 in *each* of the following and explain its meaning in each case:
 $3a, a^3, \sqrt[3]{a}, \frac{a}{3} \quad [4]$
- 64 1920_06_EA_04b Equations and Expressions: Modeling
Write in symbols: The square of twice a number diminished by twice the square root of the same number. [2]
- 65 1920_06_EA_04c Equations and Expressions: Modeling
If the width of a rectangle is represented by *w* feet, represent the width of a rectangle (1) 5 feet shorter, (2) 5 feet longer, (3) 5 times as long, (4) one fifth as long. [4]
- 66 1920_06_EA_05 Systems: Quadratic Linear
Solve the following for *x* and *y*, correctly group your answers and check either set:

$$3xy - 10x = y$$

$$2 - y = -x$$
First solution [6], second solution [2], check [2]
- 67 1920_06_EA_06 Rate, Time and Distance
A stream flows at the rate of 2 miles per hour; a launch can go at the rate of 8 miles per hour in still water. How far down the stream can the launch go and return if the complete trip can take only 6 hours? Equation [7], solution [3]
- 68 1920_06_EA_07 Equations and Expressions: Modeling
If the list price of an article is represented by *L*, and the discount a merchant offers from the list price is represented by *d* %, how would you represent the selling price in terms of *L* and *d*? Representing the selling price by *S*, make a formula for the selling price. [10]
- 69 1920_06_EA_08 Systems: Writing
In sending a telegram there is a fixed rate for the first 10 words and a fixed rate for each additional word; if a message of 31 words cost 98 cents and a message of 45 words costs \$1.40 what are these two fixed rates? Equations [7], first solution [2], second solution [1]
- 70 1920_06_EA_09 Quadratics: Solving
Solve for *x*:

$$\frac{ax}{2b} - 4b^2 = \frac{2bx}{a} - a^2 \quad [10]$$

- 71 1920_06_EA_10 Equations: Graphing
A cubic foot of water weighs 62.5 pounds. The weight of water may therefore be expressed by the formula $W=62.5V$, when W represents the weight in pounds and V represents the volume in cubic feet.
a Complete the following table and make a graph of it, i.e., make a graph of the formula $W=62.5V$: [8]
- | | | | | | |
|-----------------|---|---|---|---|---|
| V (in cu. Ft) | 1 | 2 | 4 | 6 | 8 |
| 10 | | | | | |
| W (in lb) | ? | ? | ? | ? | ? |
| ? | | | | | |
- b Show from the graph what the weight of 7 cubic feet should be.
[Leave all work on the paper.] [2]
- 72 1920_09_EA_01a Polynomials: Multiplication and Division of
Divide $20a^2 - 4 + 18a^4 + 18a - 19a^3$ by $2a^2 - 3a + 4$. Check.
- 73 1920_09_EA_01b Polynomials: Factoring
Factor *each* of the following:
 $x^2 - a^2 + y^2 - 2xy$
 $25 + 49x^2 - 70x$
 $6x^2 + 11x - 10$
 $16x^2y^6 - 36x^3y^6$
- 74 1920_09_EA_01c Polynomials: Multiplication and Division of
Simplify $\frac{b^2 - 11b + 30}{b^3 - 6b^2 + 9b} \times \frac{b^2 - 3b}{b^2 - 25} \div \frac{b^2 - 9}{b^2 + 2b - 15}$
- 75 1920_09_EA_01d Rationals: Addition and Subtraction of
Simplify $\frac{ax^2 + b}{2x - 1} + \frac{2(bx + ax^2)}{1 - 4x^2} - \frac{ax^2 - b}{2x + 1}$
- 76 1920_09_EA_01e Polynomials: Addition and Subtraction of
Add and check
 $3a + b, 5a - c, 2a + b + 4c, 2c - 3b - 2a$
- 77 1920_09_EA_01f Quadratics: Solving
Solve $\frac{4x - a}{2x - a} - 1 = \frac{x + a}{x - a}$
- 78 1920_09_EA_01g Systems: Other Nonlinear
Solve and check $\begin{cases} \frac{5}{x} - \frac{3}{y} = 7 \\ \frac{15}{y} + \frac{60}{x} = 16 \end{cases}$
- 79 1920_09_EA_01h Radicals: Simplifying
Simplify $3^3\sqrt{54} - 2\sqrt{18} + 5^3\sqrt{\frac{1}{4}} + 5\sqrt{\frac{1}{2}}$
- 80 1920_09_EA_01i Equations: Literal
From the formula $\frac{wl}{4} = \frac{sbh^2}{6}$ find the value of h .
- 81 1920_09_EA_01j Order of Operations
Simplify $2x - 3(x - 1) - [x - 2(2x - 1)]$
- 82 1920_09_EA_02 Equations and Expressions: Modeling
a If m pounds of sugar cost a cents, how much will c pounds cost?
b A has d dollars and B has 5 dollars less than four times as many dollars as A . How many dollars has B ?
c The product of two numbers is n . If one number is y , what is the other number?
- 83 1920_09_EA_03
Into what two parts may \$1000 be divided so that the income from one part at 6% shall equal the income from the other part at 4%?
- 84 1920_09_EA_04 Using Substitution with Expressions and Equations
Solve for V the formula $E = \frac{mv^2}{2}$. If $E = 19\frac{1}{2}$ and $M = \frac{1}{2}$, find the value of V to the *nearest hundredth*.
- 85 1920_09_EA_05 Radicals: Square Roots
Extract the square root of $x^4 - 2x + \frac{1}{9} + \frac{29x^2}{3} - 6x^2$
- 86 1920_09_EA_06
 A requires 3 hours longer than B to walk 30 miles, but if A should double his pace he would require 2 hours less than B ; find the rate of walking of each.

- 87 1920_09_EA_07 Systems: Other Nonlinear
A rectangle has an area of 400 square feet; if its width had been 2 feet more, the width would have been $\frac{1}{2}$ of the length. Find its dimensions.
- 88 1920_09_EA_08 Systems: Writing
In an examination the number of candidates who were successful was four times the number of those who failed; if there had been 14 more candidates and 6 fewer failures, the number of those who passed would have been 5 times the number of those who failed. Find the number of candidates.
- 89 1920_09_EA_09 Graphic Representation of Data
At 7 a.m. a man started for a town 18 miles distant, walking at the rate of 4 miles an hour; after walking for two hours, he rested half an hour, continuing in this manner till he reached his destination. Draw a graph of his journey and from the graph determine at what hour he reached his destination.
- 90 1930_01_EA_01 Consecutive Integers
If $2n + 1$ represents an odd integer, write an algebraic expression for the next larger odd integer.
- 91 1930_01_EA_02 Equations and Expressions: Modeling
The area of a rectangle equals the base times the altitude. Express this rule by a formula, using A to represent the area, b the base and h the altitude.
- 92 1930_01_EA_03 Volume
The formula for the volume of a rectangular solid is $V = l \times w \times h$. Find the height h in inches if $V = 288$ cubic inches, $l = 12$ inches, and $w = 6$ inches.
- 93 1930_01_EA_04 Polynomials: Multiplication and Division of
One algebraic expression has been divided by another. Find the dividend if the divisor is $x + 1$, the quotient $x - 3$, and the remainder 4.
- 94 1930_01_EA_05 Equations: Literal
Solve the following equation for x in terms of b , c and d :
$$\frac{c}{d} = \frac{b}{x}$$
- 95 1930_01_EA_06 Systems: Linear
Solve the following set of equations for y :
$$x + 4y = 19$$
$$2x - y = 11$$
- 96 1930_01_EA_07 Polynomials: Factoring
Write the *three* factors of $a^2c - b^2c$
- 97 1930_01_EA_08 Quadratics: Solving
Solve the following equation for the positive value of x :
$$\frac{x}{16} = \frac{4}{x}$$
- 98 1930_01_EA_09 Equations and Expressions: Using Substitution in
Given $y = \frac{4-x}{2}$; does y increase or decrease as x increases from +1 to +4?
- 99 1930_01_EA_10 Radicals: Operations with
Express as a single term $4\sqrt{32} - 3\sqrt{18}$
- 100 1930_01_EA_11 Polynomials: Multiplication and Division of
Find the quotient if $2a^2 + 7a - 15$ is divided by $a + 5$
- 101 1930_01_EA_12 Radicals: Square Roots
Find the square root of 31 to the *nearest tenth*.
- 102 1930_01_EA_13 Fractions: Complex
Perform the indicated division and express the result as a single fraction in its lowest terms:
$$\frac{15a^2}{28b^2} \div \frac{30a^2}{7b^2}$$
- 103 1930_01_EA_14 Equations and Expressions: Modeling
One half of a certain number is 10 more than $\frac{1}{6}$ of the number; find the number.

- 104 1930_01_EA_15 Rate, Time and Distance
A chauffeur drives a car at a uniform rate. If he drives the car 360 miles in p hours, how far can he drive it in q hours?

- 105 1930_01_EA_16 Quadratics: Solving
Is 2 a root of the equation $x^2 + x = 6$; that is, does it satisfy the equation? [Answer *yes* or *no*]

- 106 1930_01_EA_17 Trigonometric Functions: Properties of
As an acute angle increases from 0° to 90° , does its tangent increase or decrease?

- 107 1930_01_EA_18 Trigonometry: Finding Sides
A boy flying a kite lets out 100 feet of kite string AB . The string makes with the ground an angle A whose sine is .6694. Find the height BC of the kite.

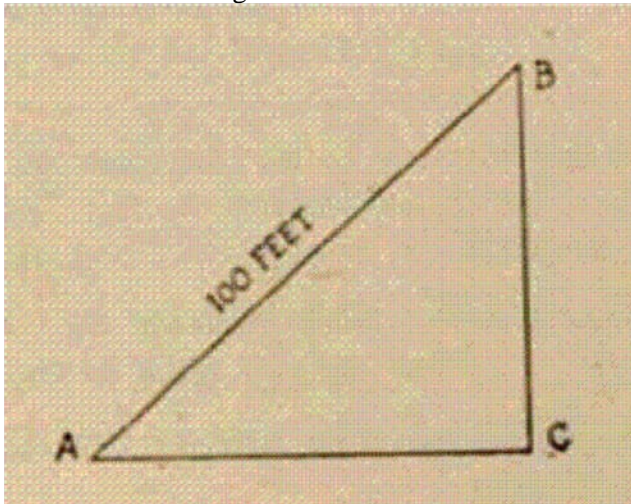

108 1930_01_EA_19_20 Equations: Graphing

a If $y = x - 3$, find the three numbers needed to complete the table given below:

x	2	4	8
y			

b On the diagram below represent by a straight line the equation $y = x - 3$, using the values for x and y found in the table in answer to a.

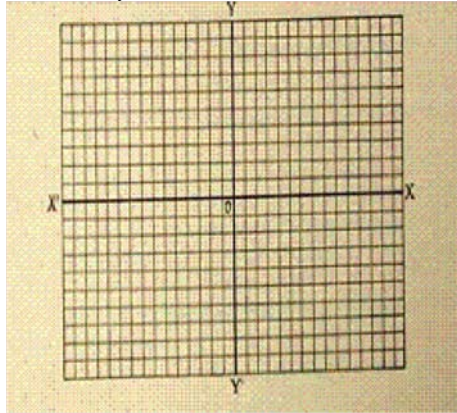

109 1930_01_EA_21 Systems: Linear

Solve the following set of equations for x and y and check:

$$\frac{x+4}{y-3} = 3$$

$$\frac{x}{6} + \frac{y}{10} = \frac{5}{6} \quad [5, 3, 2]$$

110 1930_01_EA_22 Systems: Writing

Mary is now 15 years older than her sister Jane. Ten years from now Mary will be twice as old as her sister. Find the present age of each. [6, 2, 2]

111 1930_01_EA_23 Systems: Writing

On a holiday a troop of Boy Scouts visited the county scout cabin. They rode from headquarters to the cabin at the rate of 18 miles an hour but walked back at the rate of 2 miles an hour. The round trip took 10 hours. Find the distance from the troop headquarters to the cabin. [7, 3]

112 1930_01_EA_24 Systems: Writing

Two numbers are in the ratio 3:7 and their sum is 60; find the numbers. [6,4]

113 1930_01_EA_25 Trigonometry: Finding Sides

A ladder leans against the side of a building and makes an angle of 78° with the ground. The foot of the ladder is 8 feet from the building. How high is the top of the ladder above the ground? [10]

114 1930_01_EA_26a Triangles: Pythagoras

The formula $c^2 = a^2 + b^2$ is used in finding one side of a right triangle when the other two sides are given. If $c = 13$ and $a = 5$, find b . [5]

115 1930_01_EA_26b Profit and Loss

A storekeeper can find his profits for the year by subtracting the sum of the cost of the goods and other expenses from the total sales. Write a formula that may be used in finding the profits, indicating the meaning of each letter used in the formula. [5]

116 1930_01_EA_27 Graphic Representation of Data

A power plant requires its engineer to keep a record showing the steam pressure for each hour of the day. During a part of one day the record was as follows:

6a.m. 8a.m. 10a.m. 12m. 2p.m.
30 lb 140 lb 160 lb 120 lb 140 lb

a Plot a broken-line graph showing this record. [8]

b Explain the probable cause for the rise in pressure from 6 a.m. to 10 a.m. and for the drop in pressure at the noon hour. [1,1]

117 1930_01_EA_28 Systems: Other Nonlinear

The area of a rectangular plot of ground is 640 square feet. If the length is 24 feet more than the width, find the length and the width of the plot. [6,4]

NOTE: This question is based on one of the optional topics in the syllabus.

118 1930_06_EA_01 Polynomials: Multiplication and Division of

Multiply $x^2 - 2x + 4$ by $x + 2$

- 119 1930_06_EA_02 Polynomials: Multiplication and Division of
Divide $x^3 + 2x^2 - 2x - 12$ by $x^2 + 4x + 6$
- 120 1930_06_EA_03 Rationals: Addition and Subtraction of
Combine into a single fraction: $\frac{3}{x^2 - 2x} + \frac{2}{2 - x}$
- 121 1930_06_EA_04 Polynomials: Factoring
What are the three factors of $4a^3 - ab^2$?
- 122 1930_06_EA_05 Equations: Simple
Solve the following equation for m :
 $8m - 3(2m - 5) = 23$
- 123 1930_06_EA_06 Equations: Literal
Solve the following equation for x in terms of a and b :
 $ax - b = bx$
- 124 1930_06_EA_07 Systems: Writing
Two numbers are in the ratio 7:2 and their difference is 30; what is the larger number?
- 125 1930_06_EA_08 Equations and Expressions: Using Substitution in
In the formula $L = 2\pi ra$, find L if $\pi = \frac{22}{7}$, $r = 14$, and $a = 3$
- 126 1930_06_EA_09 Equations: Simple with Fractional Expressions
Solve the following equation for d : $\frac{4d}{5} - \frac{2d}{3} = 4$
- 127 1930_06_EA_10 Systems: Linear
Solve the following set of equations for x :
 $4x - y = 10$
 $2x + 3y = 12$
- 128 1930_06_EA_11 Operations with Radicals
Express as a single term $5\sqrt{8} - 3\sqrt{18}$
- 129 1930_06_EA_12 Radicals: Square Roots
Find $\sqrt{42}$ to the nearest tenth.
- 130 1930_06_EA_13 Equations: Literal
In the formula $h = \frac{3V}{B}$, express B in terms of V and h .
- 131 1930_06_EA_14 Conversions
How many cents in the sum of x half dollars, $2x$ nickels and 7 cents?
- 132 1930_06_EA_15 Slope
If $x = 12 - 2y$ and y is positive, does x increase or decrease as y increases?
- 133 1930_06_EA_16 Graphs: Identifying Equations of
Is the graph of $y = 3x^2$ a straight line, a broken line or a curved line?
- 134 1930_06_EA_17 Equations and Expressions: Modeling
The length of a rectangle exceeds twice its width by 5. If x represents the width, express in terms of x the perimeter of the rectangle.
- 135 1930_06_EA_18 Trigonometric Functions: Inverses of
The sine of an acute angle is .6636. Find the angle to the nearest degree.
- 136 1930_06_EA_19 Trigonometric Ratios: Basic
In the right triangle ABC , what is the value of tangent A expressed as a decimal?

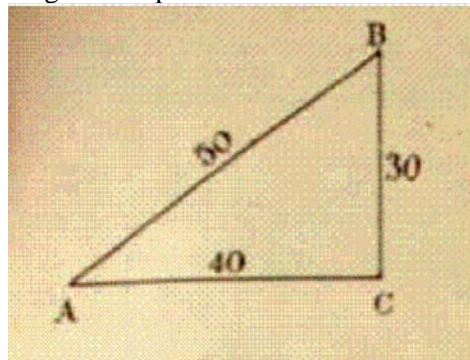

137 1930_06_EA_20 Points on a Line: Identification of

On the diagram below, locate the point $x = 4, y = 2$ and the point $x = -5, y = 5$. Draw the straight line joining these points. What is the y -value of that point on this line for which the x -value is 1?

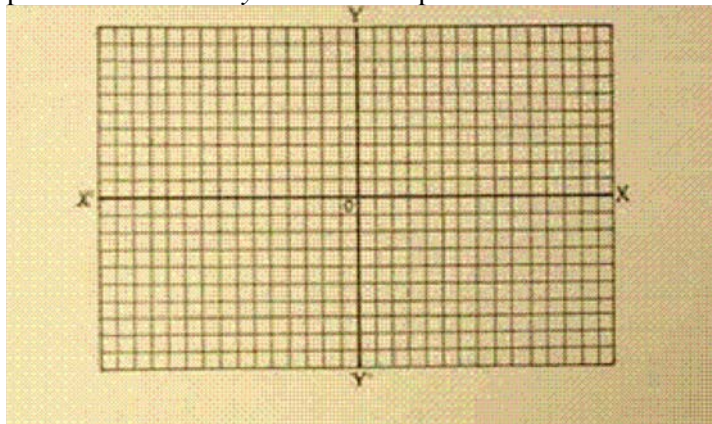

138 1930_06_EA_21 Notes and Interest

A part of \$25,000 was placed at interest at 4% and the remainder at 7%. The total interest received at the end of the year was \$1,450. How much money was placed at interest at 4%? [8,2]

139 1930_06_EA_22 Systems: Writing

The denominator of a fraction is 7 more than the numerator. If 1 is subtracted from the numerator, the value of the fraction becomes $\frac{1}{3}$. Find the original fraction. [8,2]

140 1930_06_EA_23 Alligation

How many pounds of 50-cent coffee must be mixed with 100 pounds of 25-cent coffee to make a mixture worth 42 cents a pound? [8,2]

141 1930_06_EA_24 Rate, Time and Distance

Two towns, M and N, are 200 miles apart. A truck leaves M for N at the same time that an automobile leaves N for M. The truck averages 16 miles an hour, the automobile 24 miles an hour. How far from M will they meet? [8,2]

142 1930_06_EA_25a Equations and Expressions: Using Substitution in

Indicate whether the following is true or false:
A root of the equation $x^2 - 3x + 9 = 0$ is -2. [2]

143 1930_06_EA_25b Equations and Expressions: Using Substitution in

Indicate whether the following is true or false:

If $y = 3 + \frac{2}{x}$ and x is positive and increasing, then y is decreasing. [2]

144 1930_06_EA_25c Equations and Expressions: Using Substitution in

Indicate whether the following is true or false:

If D is the dividend, d the divisor, Q the quotient and R the remainder, then $D = d \times Q + R$ [2]

145 1930_06_EA_25d Equations and Expressions: Using Substitution in

Indicate whether the following is true or false:

$\frac{ax+b}{a} = x + b$ for all values of the letters. [2]

146 1930_06_EA_25e Equations and Expressions: Using Substitution in

Indicate whether the following is true or false:

If $2n + b$ is an odd integer, then $2n + b + 4$ is an odd integer. [2]

- 147 1930_06_EA_26a Equations and Expressions: Modeling
 A gasoline dealer is allowed a profit of 2 cents a gallon for every gallon he sells. If he sells more than 25,000 gallons in a year he is given an additional profit of 1 cent for every gallon over that number. Assuming that he always sells more than 25,000 gallons a year, express as a formula the number of dollars (D) in his yearly income in terms of the number (N) of gallons sold. [6]

- 148 1930_06_EA_26b Equations: Modeling from a Table
 The following pairs of numbers represent points on a straight line:

y	6	9	1	2	3	6	30
			8	1	3	0	0
x	4	6	1	1	2	?	?
			2	4	2		

- What numbers should take the place of the question marks? [2]
 Copy and complete the following, using information given in the table:
 $x = () y$ [2]

- 149 1930_06_EA_27 Graphic Representation of Data
 The following table shows the average weight of boys and girls between the ages 10 and 14 years inclusive:
- | | | | | |
|----|--------------------------|----|----|----|
| | Age (in years) | 10 | 11 | 12 |
| 13 | 14 | | | |
| | Boys (weight in pounds) | | 63 | 68 |
| 74 | 80 | 90 | | |
| | Girls (weight in pounds) | 60 | 66 | 74 |
| 84 | 94 | | | |
- a* Draw a solid-line graph to represent the weights of boys and on the same axes a doten-line graph to represent the weight of girls. Plot ages horizontally, beginning with age 10 years, and plot weights vertically, beginning with weight 50 pounds. Use a wavy base line to indicate that values from 0 to 50 on the vertical axis have been omitted. [8]
- b* From the graph made in answer to *a*, determine how much later the normal boy reaches the weight of 80 pounds than the normal girl. [2]

- 150 1930_06_EA_28 Quadratics: Writing
 A rectangle is 6 feet long and 4 feet wide. By adding the same amount to the length and the width, the area is increased by 39 square feet. What are the new dimensions? [10]
- 151 1930_08_EA_01 Equations and Expressions: Modeling
 Express y yards as feet.
- 152 1930_08_EA_02 Equations and Expressions: Using Substitution in
 The formula $d = 16t^2$ is used to find the distance in feet, d , through which an object will fall in t seconds. How far does a ball fall in 3 seconds?
- 153 1930_08_EA_03 Quadratics: Solving
 Solve the equation $x^2 - 7 = 2$
- 154 1930_08_EA_04 Polynomials: Multiplication and Division of
 Divide $x^2 - y^2$ by $x - y$
- 155 1930_08_EA_05 Polynomials: Factoring
 What are the three factors of $8a^2 - 2$

- 156 1930_08_EA_06 Rationals: Addition and Subtraction of
Subtract $\frac{2x-3}{4}$ from $\frac{3x-1}{2}$
- 157 1930_08_EA_07 Radicals: Simplifying
Simplify $2\sqrt{\frac{3}{5}}$
- 158 1930_08_EA_08 Radicals: Simplifying
Express as a single radical $3\sqrt{5} - \frac{1}{2}\sqrt{20}$
- 159 1930_08_EA_09 Radicals: Square Roots
Find the square root of 114 to the *nearest tenth*.
- 160 1930_08_EA_10 Systems: Writing
The ratio of two positive numbers is 9 : 2 and their product is 72; find the numbers.
- 161 1930_08_EA_11 Trigonometry: Finding Sides
A and C are two points 1000 feet apart on ground level. B is a balloon directly above C. From A the angle of elevation of the balloon is 53° . How high is the balloon?
- 162 1930_08_EA_12 Variation: Inverse
The area of a rectangle is 50 square feet and its length and width are represented by l and w respectively; does l increase or decrease as w increases?
- 163 1930_08_EA_13 Equations and Expressions: Modeling
Minuend, subtrahend and remainder are represented by m , s , and r respectively. Write a formula that expresses the relation of these letters to one another.
- 164 1930_08_EA_14 Conversions
Is the equation $3x + 4y = 8$ satisfied when $x = 2$ and $y = \frac{1}{2}$? [Answer *yes* or *no*.]
- 165 1930_08_EA_15 Rationals: Solving
Solve the equation $\frac{3x}{4} - \frac{5}{2} = \frac{x}{3}$
- 166 1930_08_EA_16 Trigonometric Functions: Properties of
As angle A increases from 0° to 90° , does $\frac{\sin A}{\cos A}$ increase or decrease?
- 167 1930_08_EA_17 Equations and Expressions: Modeling
If d pencils costs b cents, what would be the cost in cents of c pencils at the same rate?
- 168 1930_08_EA_18 Systems: Linear
Solve the following set of equations for x :
 $x + 6y = 33$
 $5x - 2y = 5$
- 169 1930_08_EA_21 Systems: Writing
In a certain theater, afternoon tickets are sold at 35¢ each and evening tickets at 50¢ each. If a man paid \$4.95 for 12 tickets, how many of each kind did he buy? [6,4]
- 170 1930_08_EA_22 Trigonometry: Finding Sides
The length of a kite string is 250 feet. Assume that the string is a straight line and that it makes an angle of 43° with the ground. How high is the kite? [10]
- 171 1930_08_EA_23 Triangles: Pythagoras
The length of a rectangle is 2 greater than the side of a given square and the width is 2 less than a side of the same square. The diagonal of the rectangle is 20. If s represents one side of the square, find the value of s . [6,4]
- 172 1930_08_EA_24a Transforming Equations
Solve for F the formula $C = \frac{5}{9}(F - 32)$ [4]

- 173 1930_08_EA_24b Equations and Expressions: Using Substitution in
 If $V = \frac{4}{3} \pi r^3$, find V when $r = 7/2$ and $\pi = 22/7$ [6]
- 174 1930_08_EA_25a Proportions
 Indicate whether the following statement is true or false.

$$\frac{2}{3} = \frac{4}{9} \quad [2]$$
- 175 1930_08_EA_25b Rationals: Addition and Subtraction of
 Indicate whether the following statement is true or false.

$$\frac{a-b}{2} - \frac{b-a}{2} = a-b \quad [2]$$
- 176 1930_08_EA_25c Trigonometric Functions: Evaluating
 Indicate whether the following statement is true or false.
 The product of $\sin 90^\circ$ and $\cos 90^\circ$ is zero. [2]
- 177 1930_08_EA_25d Equations and Expressions: Using Substitution in
 Indicate whether the following statement is true or false.
 If $a = 2$, $n = 3$ and $r = 4$, then $ar^{n-1} = 64$ [2]
- 178 1930_08_EA_25e Modeling Expressions and Equations
 Indicate whether the following statement is true or false.
 The sum of two numbers is s ; if one of them is d , the other is $d - s$. [2]
- 179 1930_08_EA_26 Systems: Writing
 The ratio of the numerator of a certain fraction to its denominator is $\frac{3}{5}$. If 3 is added to the numerator and 1 to the denominator, the value of the resulting fraction is $\frac{3}{4}$. Find the fraction. [6,4]
- 180 1930_08_EA_27 Graphic Representation of Data
 Two travelers 150 miles apart start at the same time and travel towards each other at uniform rates. If one travels at the rate of 3 miles an hour and the other at the rate of 42 miles an hour, how many hours will pass before they will meet? [7, 3]
- 181 1930_08_EA_28 Systems: Linear
 a Draw the graph of the equation $x = y + 3$ [4]
 b Using the same axes, draw the graph of the equation $x = 2y$ [4]
 c What are the coordinates of the point of intersection of the two graphs? [2]
- 182 1930_08_EA_29 Rate, Time and Distance
The following question is based on one of the optional topics in the syllabus and may be substituted for any other question in part II.
 Solve the following problem *graphically*:
 Two trains start at the same time from stations 120 miles apart. They travel in the same direction and meet after a certain number of hours. One travels at an average rate of 35 miles an hour, the other at an average rate of 20 miles an hour. After how many hours of traveling will they meet if no allowance is made for stops? [10]

EY - The Eleventh Year Curriculum (1950-1960)

- 1 1950_06_EY_01 Logarithms
Find the number whose logarithm is $9.4356 - 10$.
- 2 1950_06_EY_02 Trigonometric Functions: Logarithms of
Find the logarithm of $\tan 22^\circ 18'$.
- 3 1950_06_EY_03 Trigonometry: Finding Sides
The hypotenuse of a right triangle is 12 and one of the acute angles is 28° . Find, to the *nearest tenth*, the longer leg of the triangle.
- 4 1950_06_EY_04 Fractions: Complex
Simplify the complex fraction
$$\frac{\frac{1}{\sin x} + \frac{1}{\cos x}}{\frac{1}{\sin x \cos x}}$$
- 5 1950_06_EY_05 Radicals: Rationalizing Denominators
Write the fraction $\frac{1}{\sqrt{3} - 1}$ with a rational denominator.
- 6 1950_06_EY_06 Numbers: Imaginary
Express in terms of i the sum of $\sqrt{-16}$ and $\sqrt{-9}$.
- 7 1950_06_EY_07 Equations and Expressions: Using Substitution in
Using the formula $A = P(1 + rt)$, find A when $P = 500$, $r = .03$ and $t = 15$;
- 8 1950_06_EY_08 Variation: Inverse
If r varies inversely as s and $r = 3$ when $s = 8$, find r when $s = 12$.
- 9 1950_06_EY_09 Summations
Find the sum of all the integers from 1 to 100 inclusive.
- 10 1950_06_EY_10 Trigonometric Equations
Solve the equation $\sqrt{\sin x + 3} = 2$ for the smallest positive value of x .
- 11 1950_06_EY_11 Systems: Linear
Find the abscissa of the point in which the graphs of $y = 2x$ and $y = x + 4$, when drawn on the same set of axes, intersect.
- 12 1950_06_EY_12 Equations: Writing Linear
Write the equation of the straight line whose slope is 2 and which passes through the point (3, 5).
- 13 1950_06_EY_13 Trigonometry: Reference Angles
Express $\tan 200^\circ$ as a function of a positive angle less than 45° .
- 14 1950_06_EY_14 Trigonometric Equations
Solve the equation $2 \cos^2 x + 3 \cos x - 2 = 0$ for the smallest positive value of x .
- 15 1950_06_EY_15 Trigonometric Identities
Express $\sin A$ in terms of $\tan A$ where A is an angle in the first quadrant.
- 16 1950_06_EY_16 Trigonometric Identities: Double and Half Angle
If $\tan x = a$, express $\tan 2x$ in terms of a .
- 17 1950_06_EY_17 Trigonometric Functions: Evaluating
If $\cos x = a$, express the positive value of $\cos \frac{1}{2}x$ in terms of a .
- 18 1950_06_EY_18 Exponents
Indicate whether the following statement is true or false.
The expression $x^{-2} - y^0$ is equal to $\frac{1}{x^2} - 1$.
- 19 1950_06_EY_19 Radicals: Operations with
Indicate whether the following statement is true or false.
The expression $\sqrt{x} + \sqrt{y}$ is equal to $\sqrt{x + y}$.

- 20 1950_06_EY_20 Circles: Radian Measure
Indicate whether the following statement is true or false.
An angle of an equilateral triangle is equal to one radian.
- 21 1950_06_EY_21 Quadratics: Using the Discriminant
The roots of the equation $2x^2 - 8x + 3 = 0$ are (a) equal and rational (b) unequal and rational (c) unequal and irrational
- 22 1950_06_EY_22 Logarithms
If $\log r + \log s = \log t$, then (a) $\log(r + s) = \log t$
(b) $r + s = t$ (c) $rs = t$
- 23 1950_06_EY_23 Trigonometric Graphs
As A varies from 0 to π radians, the graphs of $y = \tan A$ and $y = 2$, when drawn on the same set of axes, (a) intersect in one point (b) intersect in two points (c) do not intersect
- 24 1950_06_EY_24 Trigonometric Equations
The expression $\cos^4 \theta - \sin^4 \theta = \cos 2\theta$ is (a) true for all values of θ (b) true for only certain values of θ (c) not true for any value of θ
- 25 1950_06_EY_25 Trigonometric Functions: Evaluating
The principal value of $\sin^{-1}\left(-\frac{1}{2}\right)$ is (a) 30° (b) 210° (c) -30°
- 26 1950_06_EY_26 Systems: Quadratic Linear
Solve the following system of equations, group your answers and check *one* set. [7, 2, 1]
 $x^2 + 4y^2 = 13$
 $x - 2y = 5$
- 27 1950_06_EY_27 Systems: Writing
Write the equations that would be used in solving the following problems. In *each* case state what the letter or letters represent. [Solution of the equations is not required.]
a A man invested \$6000 in two enterprises. At the end of the first year he found that he had gained 6% on one of the sums invested and had lost 4% on the other. His net profit for the year was \$160. How much did he invest at each rate? [5]
b Three numbers are in the ratio 1:2:5. If 3 is subtracted from the first number, the second number is left unchanged and 9 is added to the third, these three numbers taken in the same order then form a geometric progression. Find the numbers. [5]
- 28 1950_06_EY_28 Trigonometric Functions: Logarithms of Angle A of triangle ABC can be found by using the formula $\cos \frac{1}{2} A = \sqrt{\frac{s(s-a)}{bc}}$ in which a , b and c are the sides of the triangle and s is one-half its perimeter. Using logarithms, find A to the *nearest degree* if $a = 26.6$, $b = 36.5$ and $c = 30.3$. [10]
- 29 1950_06_EY_29 Trigonometric Graphs
a On the same set of axes draw the graphs of $y = \sin x$ and $y = \sin 2x$ as x varies from 0 to π radians at intervals of $\frac{\pi}{6}$. [3, 5]
b From the graphs made in answer to a, determine the values of x from 0 to π radians *inclusive* that satisfy the equation $\sin x = \sin 2x$. [2]
- 30 1950_06_EY_30 Trigonometric Equations
Given the equation $\tan x - \cot x - 2 = 0$.
a Write this equation in terms of $\tan x$. [1]
b Find, to the *nearest thousandth*, the positive value of $\tan x$ which satisfies this equation. [8]
c From the result found in answer to b, find the acute angle x to the *nearest ten minutes*. [1]

- 31 1950_06_EY_31 Proofs: Trigonometric
a Starting with the formulas for $\sin(A + B)$ and $\cos(A + B)$, derive the formula for $\tan(A + B)$, in terms of $\tan A$ and $\tan B$. [4]
b Prove the following equality is an identity:

$$\frac{\cos x(1 - \cos 2x)}{\sin x} = \sin 2x$$
- 32 1950_06_EY_32 Trigonometry: Finding Sides
 Point B is 8 miles due east of point A . Point C is 3 miles from A and in the direction $N 30^\circ E$ from A .
A Find the distance from B to C . [4]
b Find, to the nearest degree, the direction of C from B . [6]
- 33 1950_06_EY_33 Trigonometry: Law of Tangents
 In triangle ABC , $A = 55^\circ 20'$, $b = 18.5$, and $c = 12.8$. Using the law of tangents, find B to the nearest minute. [10]
 * This question is based upon one of the optional topics in the, syllabus.
- 34 1950_06_EY_34a Parallel and Perpendicular Lines
 For the following statement, in which a , b and c are real numbers, indicate whether the information given is *too little*, *just enough* or *more than is necessary*, to justify the conclusion.
 If the graph of $y = mx + b$ is parallel to a line whose equation is given, then the value of m and the value of b are determined. [2]
- 35 1950_06_EY_34b Circles: Center, Radius and Circumference
 For the following statement, in which a , b and c are real numbers, indicate whether the information given is *too little*, *just enough* or *more than is necessary*, to justify the conclusion.
 If the center of a circle is at the origin and the circle passes through the point (a, b) , then the radius of the circle is $\sqrt{a^2 + b^2}$ [2]
- 36 1950_06_EY_34c Conics
 For the following statement, in which a , b and c are real numbers, indicate whether the information given is *too little*, *just enough* or *more than is necessary*, to justify the conclusion.
 If the graph of $ax^2 + by^2 = c$ is an ellipse, then a , b and c have the same sign. [2]

- 37 1950_06_EY_34d Quadratics: Graphing
 For the following statement, in which a , b and c are real numbers, indicate whether the information given is *too little*, *just enough* or *more than is necessary*, to justify the conclusion.
 If, in the equation $y = ax^2 + bx + c$, a and c are opposite in sign, then the graph of the equation intersects the x - axis. [2]
- 38 1950_06_EY_34e Conics
 For the following statement, in which a , b and c are real numbers, indicate whether the information given is *too little*, *just enough* or *more than is necessary*, to justify the conclusion.
 If, in the equation $ax^2 - by^2 = c$, a , b and c are positive and a is not equal to b , then the graph of the equation is a hyperbola. [2]
- 39 1950_06_EY_35 Trigonometry: Finding Sides Using Two Triangles
 In the accompanying figure AOC is a right triangle. Angles AOB and BOC are represented by x and y respectively.

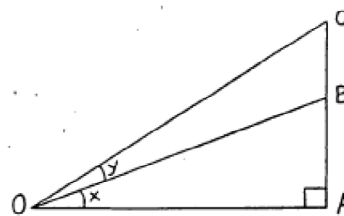

- a* Show: $BC = \frac{OB \sin y}{\cos(x + y)}$ [4]
- b* Show: $AC = OB \left[\frac{\sin y}{\cos(x + y)} + \sin x \right]$
- [4]
- c* Find AC if $x = 35^\circ 10'$, $y = 24^\circ 50'$ and $OB = 100$. [2]
- 40 1960_01_EY_01 Radicals: Rationalizing Denominators
 Express $\frac{3}{4 - \sqrt{3}}$ as an equivalent fraction with a rational denominator.
- 41 1960_01_EY_02 Trigonometric Expressions: Factoring
 Factor: $6 \sin^2 A - 7 \sin A - 10$

- 42 1960_01_EY_03 Exponents
Find the value of $(x+2)^0 + (x+1)^{-\frac{2}{3}}$ if $x = 7$.
- 43 1960_01_EY_04 Trigonometric Equations
Solve the following equation for $\sin x$: $a \sin x + b = b \sin x + c$
- 44 1960_01_EY_05 Logarithms
Find the logarithm of 0.2247
- 45 1960_01_EY_06 Trigonometric Functions: Logarithms of
Log $\cos x = 9.9273 - 10$. Find x to the *nearest minute*.
- 46 1960_01_EY_07 Progressions: Arithmetic
Find the 33rd term in the arithmetic progression 9, 6, 3,
- 47 1960_01_EY_08 Rationals: Addition and Subtraction of
Combine into a single fraction: $\frac{4}{x-2} - \frac{3}{x}$
- 48 1960_01_EY_09 Variation: Inverse
If b varies inversely as h and if $b = 8$ when $h = 9$, find b when $h = 6$.
- 49 1960_01_EY_10 Parallel and Perpendicular Lines
Write an equation of the line which is parallel to the line $y = 2x + 9$ and which passes through the point $(0, -4)$.
- 50 1960_01_EY_11 Trigonometry: Reference Angles
Express $\cos 195^\circ$ as a function of a positive acute angle.
- 51 1960_01_EY_12 Trigonometric Identities
If A is an acute angle, express $\cos A$ in terms of $\tan A$.
- 52 1960_01_EY_13 Trigonometry: Law of Sines
In triangle ABC , $a = 7$, $\sin A = 0.21$ and $\sin B = 0.36$. Find b .
- 53 1960_01_EY_14 Trigonometry: Law of Cosines
In triangle ABC , $a = 8$, $b = 10$ and $\cos C = -0.2$. Find c .
- 54 1960_01_EY_15 Trigonometry: Finding Area
In parallelogram $ABCD$, $AB = 12$, $BC = 18$ and angle $A = 120^\circ$. Find the area of $ABCD$.
- 55 1960_01_EY_16 Trigonometric Identities: Double and Half Angle
If $\sin x = \frac{1}{3}$ and x is an acute angle, find the value of $\cos 2x$.
- 56 1960_01_EY_17 Trigonometric Functions: Evaluating
If $\sin x = \frac{3}{5}$ and x is an acute angle, find the value of $\sin(45^\circ - x^0 - x)$
- 57 1960_01_EY_18 Trigonometric Functions: Evaluating
Find the value of $\cot \frac{7\pi}{6}$.
- 58 1960_01_EY_19 Equations: Forming Quadratics from Roots
The roots of the equation $x^2 + px + q = 0$ are -1 and 3. The value of p is
(1) -2 (2) 2 (3) 3 (4) -3
- 59 1960_01_EY_20 Logarithms
If $x = \log m$, then $x + 2$ equals
(1) $\log m^2$ (2) $\log 2m$ (3) $\log 100m$ (4) $\log(m+2)$
- 60 1960_01_EY_21 Quadratics: Axis of Symmetry
An equation of the axis of symmetry of the graph of the equation $y = 2x^2 + 6x - 5$ is
(1) $x = -\frac{3}{2}$ (2) $x = -3$ (3)
 $y = -\frac{3}{2}$ (4) $y = -3$

- 61 1960_01_EY_22 Exponents
The fraction $\frac{x^{-1}}{x^{-1} - y^{-1}}$ is equal to
(1) y (2) $\frac{y}{x+y}$ (3) $\frac{x+y}{x}$ (4) $\frac{x}{x+y}$
- 62 1960_01_EY_23 Trigonometric Functions: Properties of
As angle x increases from 0° to 360° , $\sin x$ and $\cos x$ both increase in
(1) Quadrant I (2) Quadrant II (3) Quadrant III (4) Quadrant IV
- 63 1960_01_EY_24 Trigonometric Functions: Properties of
The expression $3 \sin \frac{1}{2}x$ reaches its maximum value when x , expressed in radians, equals
(1) $\frac{\pi}{2}$ (2) $\frac{3}{2}$ (3) 3 (4) π
- 64 1960_01_EY_25 Circles: Radian Measure
In a circle of radius 12 inches, the number of radians in an arc 8 inches long is
(1) $\frac{2}{3}$ (2) $\frac{3}{2}$ (3) $\frac{2}{3}\pi$
(4) $\frac{3}{2}\pi$
- 65 1960_01_EY_26 Trigonometric Equations
a Solve the equation $2 \sin^2 x - 3 \sin x = 4$ for $\sin x$. [Answer may be left in radical form.] [6]
b Using the results obtained in part *a*, determine the quadrant(s) in which angle x lies. [2]
c Express the principle value of angle x in inverse trigonometric form. [2]
- 66 1960_01_EY_27 Systems: Quadratic Linear
Solve the following system of equations, group your answers and check them in both equations: [6, 2, 2]
$$x^2 - 3xy = 10$$
$$x + y = 1$$
- 67 1960_01_EY_28 Systems: Writing
Write the equations that would be used to solve the following problems. In each case state what the letter or letters represent. [Solutions of the equations is not required.]
a John can do a job in 10 minutes less time than William. One day John worked alone for 15 minutes; then William worked alone for 20 minutes to finish the job. How long would it take each working alone to do the job? [5]
b If a two-digit number is divided by the sum of the digits, the result is 4. If the digits are reversed, the new number exceeds the original number by 36. Find the original number. [5]
- 68 1960_01_EY_29 Progressions: Geometric
Three numbers are in the ratio of $1 : 2 : 3$. If 2 is added to the smallest number, the resulting number together with the other two numbers from a geometric progression. Find the original numbers. [5,5]
- 69 1960_01_EY_30 Trigonometric Graphs
a Sketch the graph of $y = \cos 2x$ as x varies from 0 to 2π radians. [4]
b On the same set of axes used in part *a*, sketch the graph of $y = \frac{1}{2} \sin x$ as x varies from 0 to 2π radians. [4]
c From the graphs made in answer to *a* and *b*, determine the number of values of x for which $\cos 2x = \frac{1}{2} \sin x$ [1]
d From the graphs made in answer to *a* and *b*, determine one value of x for which $\cos 2x - \frac{1}{2} \sin x = 1$. [1]
- 70 1960_01_EY_31 Proofs: Trigonometric
a Starting with the formulas for $\sin \frac{1}{2}x$ and $\cos \frac{1}{2}x$, derive a formula for $\tan \frac{1}{2}x$. [You may assume that x is an angle in the first quadrant.] [4]
b Prove the identity: $\tan 2x \csc x = \frac{2 \cos x}{\cos 2x}$ [6]

- 71 1960_01_EY_32 Trigonometric Functions: Logarithms of
Using logarithms, find to the *nearest tenth* the value
of $\frac{\tan 75^\circ (4.66)^2}{\sqrt[3]{0.941}}$. [10]
- 72 1960_01_EY_33 Trigonometry: Law of Cosines
In triangle ABC , $a = 25$, $b = 31$ and $c = 14$. Find
the angle B to the *nearest ten minutes*. [10]
- 73 1960_01_EY_34 Trigonometry: Law of Sines
Lighthouse B is 3.7 miles east of lighthouse A . The
bearing of a ship C from lighthouse A is $S 12^\circ 50'$
 W and the bearing of C from lighthouse B is $S 61^\circ$
 $40' W$. Find to the *nearest tenth of a mile* the
distance of the ship from B . [5,5]
- 74 1960_01_EY_35 Proofs: Trigonometric
Prove the identity: $\frac{\sin 2y + \sin y}{\sin 3y - \sin y} = \frac{2 \cos^2 y}{2 \cos^2 y - 1}$
[10]
* This question is based on one of the optional
topics in the syllabus.
- 75 1960_06_EY_01 Numbers: Complex
Express as a single term the sum of $6i$ and $\sqrt{-9}$.
- 76 1960_06_EY_02 Exponents
If $x = 4$, find the value of $4x^{\frac{1}{2}} + (x^0 + 3)^{-1}$
- 77 1960_06_EY_03 Rationals: Addition and Subtraction of
Perform the indicated operations and express the
result in *simplest* form:
 $\left(1 + \frac{1}{x}\right)\left(\frac{1}{x+1} - 1\right)$
- 78 1960_06_EY_04 Solving Quadratics by Factoring
Find the positive value of t which satisfies the
equation
 $2t^2 + 5t - 33 = 0$
- 79 1960_06_EY_05 Radicals: Rationalizing Denominators
Express $\frac{2}{4 - \sqrt{7}}$ as an equivalent fraction with a
rational denominator.
- 80 1960_06_EY_06 Variation: Inverse
If x varies inversely as y and if $x = 12$ when $y = 8$,
find x when $y = 10$.
- 81 1960_06_EY_07 Equations: Forming Quadratics from Roots
If the roots of the equation $x^2 + kx + t = 0$ are 3
 $+\sqrt{2}$ and $3 - \sqrt{2}$, find the value of k .
- 82 1960_06_EY_08 Equations: Writing Linear
Write an equation of the line which passes through
the point $(0, -3)$ and which has the same slope as
the line whose equation is $y = 2x + 6$.
- 83 1960_06_EY_09 Systems: Writing
Write an equation in x and y by eliminating t from
the system:
 $x = t - 1$
 $y = 3t + 4$
- 84 1960_06_EY_10 Progressions: Arithmetic
Find the 57^{th} term of the arithmetic progression 20 ,
 $16, 12, \dots$
- 85 1960_06_EY_11 Consecutive Integers
If the sum of three consecutive numbers is S ,
express in terms of S the *smallest* of these numbers.
- 86 1960_06_EY_12 Trigonometric Functions: Inverses of
Find, to the *nearest minute*, the positive acute angle
whose cosine is 0.2500 .
- 87 1960_06_EY_13 Trigonometric Functions: Evaluating
Find the positive value of $\sin \frac{1}{2}x$ if $\cos x = 0.02$.
- 88 1960_06_EY_14 Circles: Radian Measure
Find the number of radians in a central angle of a
circle of radius 6 if the length of the intercepted arc
is 12 .

- 89 1960_06_EY_15 Trigonometry: Law of Cosines
In triangle ABC , $a = 5$, $b = 6$ and $c = 8$. Find $\cos A$.
- 90 1960_06_EY_16 Trigonometry: Law of Sines
In triangle ABC , $a = 24$, $b = 20$ and $\sin A = 0.24$. Find $\sin B$.
- 91 1960_06_EY_17 Trigonometric Equations
Find in *degrees* the value of x greater than 0° and less than 360° which satisfies the equation $\tan x - \tan x \cos x = 0$.
- 92 1960_06_EY_18 Trigonometric Functions: Evaluating
If t is greater than zero, find the positive value of $\tan(\text{arc cot } t)$.
- 93 1960_06_EY_19 Trigonometry: Finding Area
In triangle ABC , $A = 50^\circ$ and $B = 100^\circ$. The area of the triangle is
(1) $\frac{1}{2} ab \sin 50^\circ$ (2) $\frac{1}{2} ab \sin 100^\circ$ (3) $\frac{1}{2} ab$ (4) $\frac{1}{4} ab$
- 94 1960_06_EY_20 Trigonometric Functions: Evaluating
If $k = 30^\circ$, the value of $\tan 2k + \cos 3k$ is
(1) $\sqrt{3}$ (2) $\frac{\sqrt{3}}{3}$ (3) $\sqrt{3} + 1$ (4) $\frac{\sqrt{3} + 3}{3}$
- 95 1960_06_EY_21 Radicals: Solving
The equation $x + \sqrt{x-2} = 2$ has
(1) both 2 and 3 as roots
(2) 2 as its only root
(3) 3 as its only root
(4) neither 2 nor 3 as roots
- 96 1960_06_EY_22 Logarithms
If $T = 10x^2$, then $\log T$ equals
(1) $1 + 2 \log x$
(2) $1 + 2x$
(3) $10 + 2 \log x$
(4) $20 \log x$
- 97 1960_06_EY_23 Quadratics: Using the Discriminant
If the roots of the equation $2x^2 - 3x + c = 0$ are real and irrational, then the value of c may be
(1) 1 (2) 2 (3) 0 (4) -1
- 98 1960_06_EY_24 Numbers: Properties of Real
An illustration of the distributive law is
(1) $(ab)c = a(bc)$
(2) $(a+b)+c = a+(b+c)$
(3) $a(b+c) = ab+ac$
(4) $ab+ac = ac+ab$
- 99 1960_06_EY_25 Systems: Other Nonlinear
The graphs of the equations $x^2 + y^2 = 25$ and $y = x^2$ are drawn on the same set of axes. The total number of points common to these graphs is
(1) one (2) two (3) three (4) four
- 100 1960_06_EY_26 Trigonometric Graphs
The period of the curve $y = 2 \sin x$ is
(1) π (2) 2 (3) 2π (4) $\frac{\pi}{2}$
- 101 1960_06_EY_27 Trigonometric Identities
An example of an identity is
(1) $\sin^2 x - \cos^2 x = 1$
(2) $\frac{1}{\sec^2 x} + \frac{1}{\csc^2 x} = 1$
(3) $\tan^2 x = 1 + \sec^2 x$
(4) $\sin x + \cos x = 1$
- 102 1960_06_EY_28 Trigonometric Identities
The expression $\cos(90^\circ + \theta)$ equals
(1) $\cos \theta$ (2) $-\cos \theta$ (3) $\sin \theta$
(4) $-\sin \theta$
- 103 1960_06_EY_29 Trigonometric Functions: Evaluating
If $\tan A = \frac{2}{3}$, then the value of $\tan 2A$ is
(1) $\frac{12}{5}$ (2) $\frac{12}{13}$ (3) $\frac{6}{5}$
(4) $\frac{4}{3}$

- 104 1960_06_EY_30 Trigonometric Graphs
On the coordinate axes at the right, *sketch* the graph of $y = \cos 2x$ from $x = 0$ to $x = \pi$.

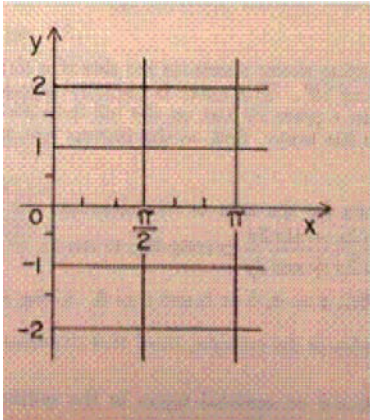

- 105 1960_06_EY_31 Systems: Other Nonlinear
With respect to a certain rectangle and a certain square these facts are known : The sum of their area is 68, the length of the rectangle is twice its width and a side of the square exceeds the width of the rectangle by 2. Find the dimensions of the rectangle and the length of a side of the square [Only an algebraic solution will be accepted.] [5, 5]

- 106 1960_06_EY_32a Quadratics: $a > 1$
Find, in *radical form*, the roots of the equation $3x^2 - 2x = 2$. [5]

- 107 1960_06_EY_32b Systems: Quadratic Linear
Find *one* set of answers which satisfies the following system of equations: [5]

$$\begin{aligned}x^2 + xy &= 12 \\ y &= x - 2\end{aligned}$$

- 108 1960_06_EY_33a Trigonometric Equations
Find all positive values of x less than 360° that satisfy the equation $2 \sin^2 x = 1 + \sin x$. [6]

- 109 1960_06_EY_33b Proofs: Trigonometric
Prove that the following equality is an identity: [4]

$$\frac{\tan x \csc^2 x}{1 + \tan^2 x} = \cot x$$

- 110 1960_06_EY_34a Trigonometric Formulas: Derivations of
Starting with the formula for $\cos(x + y)$, *derive* a formula for $\cos 2x$ in terms of $\cos x$. [5]

- 111 1960_06_EY_34b Trigonometric Identities
In the figure at the right $AB \parallel CD$, $BC \perp AC$ and $BD \perp CD$.

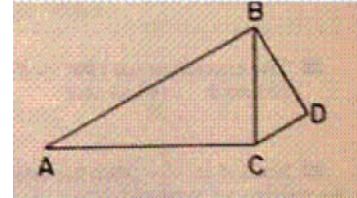

- If $AB = 1$ and angle $BAC = x$, show that $CD = \sin^2 x$. [5]

- 112 1960_06_EY_35 Equations: Logarithmic
Given the formula $V = \pi r^2 h$. By means of logarithms, find to the *nearest tenth* the value of r when $V = 5340$ and $h = 14.6$. [Use the approximation $\pi = 3.14$.] [10]

- 113 1960_06_EY_36 Trigonometry: Law of Sines
A vertical transmitting tower stands on the side of a hill which is uniformly inclined to the horizontal at an angle of 18° . The tower is partially supported by a cable which reaches from the top of the tower to a point 60 feet up the hill from the base of the tower. If this cable makes an angle of 38° with the tower, find, to the *nearest foot*, the height of the tower. [5, 5]

- 114 1960_06_EY_37a Trigonometric Identities: Angle Sum or Difference
Use the formula for the sum of two sines and the formula for the sum of two cosines and show that $\frac{\sin 2x + \sin 2y}{\cos 2x + \cos 2y}$ is reducible to $\tan(x + y)$. [5]

- 115 1960_06_EY_37b Trigonometric Identities: Double and Half Angle
In triangle ABC , $a = 4$, $b = 6$ and $c = 8$. Using a formula for a function of a half angle in terms of the sides of the triangle, show that the value of $\cos \frac{1}{2} C$ is $\frac{\sqrt{6}}{4}$. [5]
* This question is based on optional topics in the syllabus.
- 116 1960_08_EY_01 Radicals: Rationalizing Denominators
Express $\frac{3}{\sqrt{5}-1}$ as an equivalent fraction with a rational denominator.
- 117 1960_08_EY_02 Exponents
Write in *simplest form* the value of $3x^0 + x^{\frac{2}{3}}$ if $x = 8$.
- 118 1960_08_EY_03 Trigonometric Functions: Evaluating
Find $\cos 41^\circ 12'$.
- 119 1960_08_EY_04 Logarithms
Find the number whose logarithm is 9.8472 1–10.
- 120 1960_08_EY_05 Progressions: Arithmetic
Find the 20th term in the arithmetic progression 2, 5, 8, 11,
- 121 1960_08_EY_06 Trigonometric Identities
If angle A is in quadrant I, express $\tan A$ in terms of $\sin A$.
- 122 1960_08_EY_07 Trigonometric Equations
Solve the equation $\sqrt{2 \cos x + 10} = 3$ for the smallest positive value of x .
- 123 1960_08_EY_08 Trigonometry: Law of Cosines
In triangle ABC , $a = 5$, $b = 7$ and $\cos C = \frac{1}{7}$. Find the length of side c .
- 124 1960_08_EY_09 Trigonometric Identities: Double and Half Angle
Find the positive value of $\cos \frac{1}{2} \theta$ if $\cos \theta = \frac{1}{8}$.
- 125 1960_08_EY_10 Progressions: Geometric
In a geometric progression whose terms are all positive, the fifth term is 6 and the seventh term is 12. Find the sixth term of this progression.
- 126 1960_08_EY_11 Trigonometry: Reference Angles
Express $\cos 260^\circ$ as a function of a positive acute angle.
- 127 1960_08_EY_12 Slope
Find the slope of the line whose equation is $x + 2y = 4$.
- 128 1960_08_EY_13 Trigonometric Expressions: Factoring
Factor: $15 \cos^2 x + 7 \cos x - 4$.
- 129 1960_08_EY_14 Scientific Notation
If the number 0.0068 is expressed in the form 6.8×10^n , find the value of n .
- 130 1960_08_EY_15 Equations and Expressions: Using Substitution in
Using the formula $C = \frac{5}{9}(F - 32)$, find F if $C = 80$.
- 131 1960_08_EY_16 Rationals: Solving
Solve for x : $\frac{1}{a} - \frac{1}{x} = \frac{1}{b}$
- 132 1960_08_EY_17 Quadratics: Axis of Symmetry
What is the abscissa of the turning point of the graph whose equation is $y = x^2 + 6x + 8$?
- 133 1960_08_EY_18 Trigonometry: Finding Area
Two sides of a triangle are 6 and 10 and the included angle is 120° . Find the area of the triangle.

- 134 1960_08_EY_19 Circles: Radian Measure
In a circle whose radius is 20 inches, a central angle intercepts an arc of 15 inches. Find the number of radians in the central angle.
- 135 1960_08_EY_20 Quadratics: Sum and Product of Roots
Find the sum of the roots of the equation $x^2 + 2x + 5 = 0$.
- 136 1960_08_EY_21 Trigonometric Identities
Indicate whether the following statement is true for
a all real values of x ,
b some but not all real values of x ,
c no real value of x ,
 $\cos^2 x - \sin^2 x = \cos^2 x - \sin^2 x$
- 137 1960_08_EY_22 Numbers: Imaginary
Indicate whether the following statement is true for
a all real values of x ,
b some but not all real values of x ,
c no real value of x ,
 $x^2 + 4 = 0$
- 138 1960_08_EY_23 Numbers: Properties of Real
Each of the following is an equivalent form of the expression $\tan A + \sin A$. Which one is an illustration of the commutative principle?
(1) $\frac{1}{\cot A} + \frac{1}{\csc A}$
(2) $\frac{\sin A}{\cos A} + \sin A$
(3) $\sin A + \tan A$
(4) $\cot(90^\circ - A) + \cos(90^\circ - A)$
- 139 1960_08_EY_24 Trigonometric Graphs
The period of the function $4 \sin \frac{1}{2}x$ is
(1) $\frac{1}{2}\pi$ (2) π (3) 2π (4) 4π
- 140 1960_08_EY_25 Trigonometric Functions: Evaluating
The positive value of $\sin\left(\arccos \frac{\sqrt{2}}{2}\right)$ is equal to
(1) 30° (2) 60° (3) $\frac{1}{4}$ (4) $\frac{1}{2}$
- 141 1960_08_EY_26 Numbers: Imaginary
When expressed in terms of the imaginary unit I , $\sqrt{-3}$ is
(1) $3i$ (2) $-3i$ (3) $i\sqrt{3}$
(4) $-i\sqrt{3}$
- 142 1960_08_EY_27 Conics
The graph of $2x^2 + 3y^2 = 6$ is
(1) a circle (2) an ellipse (3) a hyperbola (4) a parabola
- 143 1960_08_EY_28 Trigonometric Equations
A value for y which satisfies the equation $\tan^2 y = 1$ is
(1) π (2) 2π (3) $\frac{\pi}{2}$ (4) $\frac{\pi}{4}$
- 144 1960_08_EY_29 Trigonometric Functions: Evaluating
If $A = 90^\circ$ and $B = 30^\circ$, then $\sin A - \sin B$ equals
(1) $\frac{1}{2}$ (2) $-\frac{1}{2}$ (3) $1 - \frac{\sqrt{3}}{2}$ (4) $\frac{\sqrt{3}}{2}$
- 145 1960_08_EY_30 Trigonometric Graphs
As x increases from 0 to π radians, the graphs of $y = \cos x$ and $y = \frac{1}{2}$, when drawn on the same axes,
(1) are tangent
(2) intersect in two points
(3) intersect in only one point
(4) do not intersect
- 146 1960_08_EY_31 Quadratics: $a > 1$
Find the *nearest tenth* the roots of the equation $2x^2 - 9x = 1$. [10]

- 147 1960_08_EY_32 Trigonometry: Finding Sides Using Two Triangles
 An observer in a boat finds the angle of elevation of a beacon of light on a mountain top to be $46^\circ 40'$. The boat is due east of the beacon light. After the boat moves 1,000 feet further east, the new angle of elevation of the beacon light is $42^\circ 10'$. Find to the nearest ten feet the height of the beacon light above the eye of the observer. [5,5]

- 148 1960_08_EY_33 Systems: Writing
 How many pounds of water must be evaporated from 84 pounds of a 20% salt solution to raise it to a 35% salt solution? [6,4]

- 149 1960_08_EY_34 Trigonometric Identities: Double and Half Angle
 a In the accompanying diagram, angle B is a right angle and AC bisects angle DAB in triangle ABD . Using this diagram, derive the formula

$$AC = \frac{AD \cos 2x}{\cos x}. \quad [6]$$

 b If $AD = 210$ feet and $x = 34^\circ$, find AC to the nearest foot. [4]

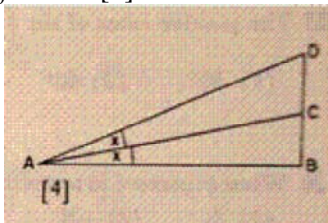

- 150 1960_08_EY_35 Trigonometric Formulas: Derivations of
 a Starting with a formula for $\cos 2x$, derive the formula for $\cos \frac{1}{2} \theta$ in terms of $\cos \theta$. [5]
 b Show that the following equality is an identity: [5]

$$\frac{\cos(x-y)}{\sin x \sin y} = 1 + \cot x \cot y$$

- 151 1960_08_EY_36 Trigonometric Graphs
 a Draw the graph of $y = x^2 + 3x - 2$, using all integral values of x from $x = -5$ to $x = 2$, inclusive. [6]
 b Using the graph made in answer to part a, find to the nearest tenth the roots of the equation $x^2 + 3x - 2 = 1$. [4]

- 152 1960_08_EY_37 Trigonometric Equations
 Solve the following equation for all values of x greater than 0° but less than 90° : [10]

$$\frac{\sin 5x + \sin x}{\cos 5x + \cos x} = \frac{1}{3} \sqrt{3}$$

 * This question is based upon an optional topic in the syllabus.

EY - The Eleventh Year Curriculum (1970-1980)

- 153 1970_01_EY_01 Quadratics: Difference of Perfect Squares
Factor: $y^2 - .09x^2$
- 154 1970_01_EY_02 Scientific Notation
If the number 3,100,000 is written in the form 3.1×10^n , find the value of n .
- 155 1970_01_EY_03 Equations: Literal
Solve for x in terms of a :
 $x + y = 2a$
 $x - y = a$
- 156 1970_01_EY_04 Numbers: Complex
Multiply the complex numbers $(3 - 5i)$ and $(2 + 3i)$ and express the product in the form $a + bi$.
- 157 1970_01_EY_05 Logarithms
If $\log \sin x = 9.5807 - 10$, find the acute angle x to the nearest minute.
- 158 1970_01_EY_06 Radicals: Solving
Find the solution set of $\sqrt{x^2 + 5} - 1 = x$.
- 159 1970_01_EY_07 Trigonometric Equations
Find in degrees the value of A greater than 270° and less than 360° which satisfies the equation $\tan A - \cot A = 0$.
- 160 1970_01_EY_08 Rationals: Solving
What is the numerator of a fraction whose denominator is $3a^2 - 6$ if the fraction is equal to $\frac{2}{3}$?
- 161 1970_01_EY_09 Circles: Center, Radius and Circumference
If an arc 20 feet long subtends an angle of 2 radians at the center of the circle, what is the number of feet in the radius of the circle?
- 162 1970_01_EY_10 Exponential Functions and Equations
If $10^{0.3247} = 2.112$, what is the value of $10^{2.3247}$?
- 163 1970_01_EY_11 Trigonometry: Reference Angles
Express $\tan(-140^\circ)$ as a function of a positive acute angle.
- 164 1970_01_EY_12 Equations: Writing Linear
Write an equation of the straight line which passes through the points $(0, -1)$ and $(1, 2)$.
- 165 1970_01_EY_13 Variation: Inverse
If y varies inversely as x and $y = 6$ when $x = 7$, what is the value of y when $x = 3$?
- 166 1970_01_EY_14 Trigonometric Functions: Evaluating
If $\sin x = -\frac{1}{3}$, find the value of $\cos 2x$.
- 167 1970_01_EY_15 Trigonometry: Law of Cosines
The sides of a triangle are 5, 8, and 9. Find the cosine of the largest angle.
- 168 1970_01_EY_16 Equations: Absolute Value
Find the solution set of $|x - 5| = 11$.
- 169 1970_01_EY_17 Polynomials: Factoring
Express $x^2 + ax + bx + ab$ as the product of two binomial factors.
- 170 1970_01_EY_18 Equations and Expressions: Using Substitution in
If $x = -2$, which is not an expression for zero?
(1) $\frac{0}{x}$ (2) $x - 2$ (3) $x^2 - 4$ (4) $x + (-x)$
- 171 1970_01_EY_19 Quadratics: Using the Discriminant
The roots of the quadratic equation $x^2 - 8x + 17 = 0$ are
(1) real, unequal, and rational
(2) real, equal, and rational
(3) real, equal, and irrational
(4) imaginary

- 172 1970_01_EY_20 Trigonometry: Law of Sines
 In triangle ABC, angle $B=40^\circ$, $b=8$, and $c=6$.
 Angle C
- (1) must be acute
 - (2) must be obtuse
 - (3) must be a right angle
 - (4) may be either acute or obtuse

- 173 1970_01_EY_21 Numbers: Complex
 The multiplicative inverse of $3+i$ is
- (1) $3-i$
 - (2) $\frac{3-i}{8}$
 - (3) $\frac{3+i}{8}$
 - (4) $\frac{3-i}{10}$

- 174 1970_01_EY_22 Quadratics: Sum and Product of Roots
 The sum of the roots of the equation $x^2 - 7x + 2 = 0$
 exceeds the product of the roots by
- (1) -9
 - (2) -5
 - (3) 5
 - (4) 9

- 175 1970_01_EY_23 Trigonometric Identities
 For all values of the variables for which the
 expression is defined, which statement of equality
 is an identity?
- (1) $\sqrt{c^2 - a^2} = c - a$
 - (2) $\sec^2 \theta - \tan^2 \theta = 1$
 - (3) $\sin 2x = 2 \sin x$
 - (4) $\sin \theta \sec \theta = 1$

- 176 1970_01_EY_24 Radicals: Operations with
 The expression $\sqrt{\frac{4}{3}} - \sqrt{\frac{3}{4}}$ is equivalent to
- (1) 1
 - (2) 0
 - (3) $\frac{\sqrt{3}}{6}$
 - (4) $2\sqrt{3}$

- 177 1970_01_EY_25 Trigonometric Functions: Properties of
 If angle A terminates in quadrant II and angle B
 terminates in quadrant III, which can *not* be true?
- (1) $\sin A = \sin B$
 - (2) $\sin A = \tan B$
 - (3) $\cos A = \cos B$
 - (4) $\cos A = \sin B$

- 178 1970_01_EY_26 Trigonometric Functions: Evaluating
 The value of $\cos \pi - \cos \frac{3\pi}{4}$ is
- (1) $\frac{-2 + \sqrt{2}}{2}$
 - (2) $\frac{-2 - \sqrt{2}}{2}$
 - (3) $\frac{\sqrt{2}}{2}$
 - (4) $\frac{-\sqrt{2}}{2}$

- 179 1970_01_EY_27 Trigonometric Graphs
 What is the period of the graph of $y = 2 \sin 3x$?
- (1) $\frac{\pi}{3}$
 - (2) $\frac{2\pi}{3}$
 - (3) π
 - (4) 6π

- 180 1970_01_EY_28 Trigonometric Functions: Evaluating
 The positive value of $\cos(\arcsin a)$ is
- (1) $\frac{1}{1-a^2}$
 - (2) $\frac{1}{\sqrt{1-a^2}}$
 - (3) $1-a^2$
 - (4) $\frac{\sqrt{3}}{4}$

- 181 1970_01_EY_29 Trigonometry: Law of Sines
 In $\triangle ABC$, $a=5$, $b=10$, and $B=150^\circ$. The value of $\sin A$ is
- (1) 1
 - (2) $\sqrt{3}$
 - (3) $\frac{1}{4}$
 - (4) $\frac{\sqrt{3}}{4}$
- 182 1970_01_EY_30 Quadratics: Inequalities
 The solution set of the inequality $x^2 - x - 6 < 0$ is
- (1) $x < -2$ or $x > 3$
 - (2) $x < -3$ or $x > 2$
 - (3) $-2 < x < 3$
 - (4) $-3 < x < 2$
- 183 1970_01_EY_31a Quadratics: $a > 1$
 Find to the *nearest tenth* the roots of the equation $2x^2 - 7 = 3x$ [8]
- 184 1970_01_EY_31b Trigonometric Equations
 If $x = \tan \theta$ in the equation $2x^2 - 7 = 3x$ and θ lies in the interval $180^\circ < \theta < 270^\circ$, find θ to the *nearest degree*. [2]
- 185 1970_01_EY_32 Trigonometric Formulas: Derivations of
- a Starting with the formula for $\tan(x + y)$ derive the formula for $\tan 2x$ in terms of $\tan x$. [3]
 - b For all x for which the expression is defined, show that the following is an identity: [7]
- $$\frac{1}{\tan x - \cot x} = \frac{\sin x \cos x}{2 \sin^2 x - 1}$$
- 186 1970_01_EY_33 Systems: Other Nonlinear
 Solve the following system of equations, and check in both equations: [8,2]
- $$x^2 - 2y^2 = 13$$
- $$x - 2y = 2$$
- 187 1970_01_EY_34 Trigonometric Graphs
- a On the same set of axes sketch the graphs of $y = \sin 2x$ and $y = 2 \cos x$ for all values of x which are in the interval $0 \leq x \leq \pi$ [4,4]
 - b For what value (s) of x in the interval $0 \leq x \leq \pi$ is $\sin 2x = 2 \cos x$? [2]
- 188 1970_01_EY_35 Trigonometric Functions: Logarithms of
 Using *logarithms*, find to the *nearest hundredth* the value of $\frac{\sqrt[3]{71.5 \sin 14^\circ 10'}}{3.81}$. [10]
- 189 1970_01_EY_36 Systems: Writing
 Write an equation or a system of equations which can be used to solve *each* of the following problems. In each case state "what the variable or variables represent. [*Solution of the equations is not required.*]
- a A motorist starts from city A at 60 miles per hour and travels toward city B on a certain route. After traveling some time on this route, he encounters road construction along the remaining portion which requires him to reduce his speed to 40 miles per hour for the remainder of the trip. If the portion of the road on which he traveled 60 miles per hour is 60 miles longer than that on which he traveled 40 miles per hour and the total time of the trip is 6 hours, how many miles did the motorist travel at the slower speed? [5]
 - b How many quarts of water must be evaporated from 20 quarts of a 25% salt solution to make it a 30% salt solution? [5]
- 190 1970_01_EY_37a Triangles: Vectors
 Two forces act on a point at an angle of 102° . The first is a force of 130 pounds. If the resultant makes an angle of $38^\circ 20'$ with the first force, what is the magnitude of the resultant to the *nearest pound*? [4,6]

- 191 1970_01_EY_37b Trigonometry: Law of Cosines
A local airline does not offer a direct connection from city A to city B . Rather, the flight travels 70 miles from city A to city C and then 100 miles from city C to city B . If the angle ACB between the two legs of the flight is 100° , find to the *nearest mile* the distance between A and B . [3,7]
- 192 1970_06_EY_01 Trigonometry: Finding Area
What is the area of $\triangle ABC$ if $a = 20$, $b = 12$, and $C = 30^\circ$?
- 193 1970_06_EY_02 Circles: Radian Measure
Express in degrees an angle of $\frac{4\pi}{5}$ radians.
- 194 1970_06_EY_03 Trigonometric Equations
Find in degrees the acute angle x for which $\sin x = \cos(x + 10^\circ)$.
- 195 1970_06_EY_04 Trigonometry: Law of Sines
In $\triangle ABC$, $a = 7.0$, $b = 20$, and $\sin A = 0.21$. Find the value of $\sin B$.
- 196 1970_06_EY_05 Equations: Absolute Value
If $|x| = 4$ and $x + 3 > 0$, find the solution set.
- 197 1970_06_EY_06 Trigonometric Equations
Solve for the positive value of $\cos x$:
 $2\cos^2 x + \cos x - 1 = 0$.
- 198 1970_06_EY_07 Rationals: Solving
Solve for x : $\frac{2x+1}{5} - \frac{3x-7}{2} = 7$
- 199 1970_06_EY_08 Trigonometric Functions: Evaluating
Find the value of $\sin\left(\arccos\frac{8}{17}\right)$
- 200 1970_06_EY_09 Trigonometry: Reference Angles
Express $\tan 307^\circ$ as a function of a positive acute angle.
- 201 1970_06_EY_10 Trigonometric Functions: Evaluating
Find the value of $\cos 29^\circ 36'$.
- 202 1970_06_EY_11 Variation: Direct
After a car's brakes are applied, the distance d a car travels before stopping varies directly as the square of its velocity v . If d is 32 feet when v is 40 m.p.h., find the distance d in feet when v is 60 m.p.h.
- 203 1970_06_EY_12 Parallel and Perpendicular Lines
Write an equation of the straight line that is parallel to the line whose equation is $5x - y = 3$ and passes through the point $(0, -5)$.
- 204 1970_06_EY_13 Trigonometry: Law of Cosines
In triangle ABC , $a = 4$, $b = 5$, and $\cos C = -\frac{1}{5}$. Find the value of c .
- 205 1970_06_EY_14 Numbers: Complex
For all a and b , what is the additive inverse of the complex number $a + bi$?
- 206 1970_06_EY_15 Trigonometric Functions: Properties of
In which quadrant does an angle lie whose cosecant is negative and whose secant is positive?
- 207 1970_06_EY_16 Quadratics: Sum and Product of Roots
If the sum of the roots of $x^2 - x - 7 = 0$ is added to the product of the roots of this equation, what is the numerical value of the result?
- 208 1970_06_EY_17 Polynomials: Factoring
The expression $\frac{ax + ay}{a^2 + 3ax + 2x^2}$, in which $a \neq 0$ and $a \neq -2x$, is equivalent to
- (1) $\frac{-y}{2x}$
 - (2) $\frac{y}{2x}$
 - (3) $\frac{y}{a - 2x}$
 - (4) $\frac{y}{a + 2x}$

- 209 1970_06_EY_18 Equations: Literal
If $ar^n - rx = 0$, then an expression for x in terms of a , n , and r is
- (1) $x = ar^n$
 - (2) $x = ar^{n+1}$
 - (3) $x = ar^{n-1}$
 - (4) $x = ar^{2n}$
- 210 1970_06_EY_19 Consecutive Integers
Which equation can be used in finding n , when n is the *smallest* of three consecutive odd integers whose sum is s ?
- (1) $(n) + (n + 1) + (n + 2) = s$
 - (2) $(n) + (n + 1) + (n + 3) = s$
 - (3) $(n) + (n + 2) + (n + 4) = s$
 - (4) $(n) + (3n) + (5n) = s$
- 211 1970_06_EY_20 Systems: Other Nonlinear
The graphs of $y = x^2$ and $y = 2x$ intersect in two points, one of which is the origin. What are the coordinates of the other point?
- (1) (1,2)
 - (2) (2,4)
 - (3) (2,1)
 - (4) (4,2)
- 212 1970_06_EY_21 Radicals: Rationalizing Denominators
The expression $\frac{3}{\sqrt{3} - \sqrt{2}}$ is equal to
- (1) $3\sqrt{6}$
 - (2) $3\sqrt{3} + 3\sqrt{2}$
 - (3) $\frac{(\sqrt{3} - \sqrt{2})}{2}$
 - (4) $\frac{(\sqrt{3} + \sqrt{2})}{2}$
- 213 1970_06_EY_22 Trigonometric Functions: Properties of
As angle x increases from $\frac{\pi}{4}$ to $\frac{3\pi}{2}$, $\cos x$
- (1) increases throughout the interval
 - (2) decreases throughout the interval
 - (3) increases, then decreases
 - (4) decreases, then increases
- 214 1970_06_EY_23 Trigonometric Identities
For all values of θ for which the expression is defined, $\frac{\tan \theta}{\sin \theta}$ is equivalent to
- (1) $\sec \theta$
 - (2) $\cot \theta$
 - (3) $\sin \theta$
 - (4) $\cos \theta$
- 215 1970_06_EY_24 Quadratics: Using the Discriminant
The roots of $x^2 + 6x - 7 = 0$ are
- (1) real, rational, and equal
 - (2) imaginary
 - (3) real, irrational, and unequal
 - (4) real, rational, and unequal
- 216 1970_06_EY_25 Functions: Defining
Which one of the following equations defines a relation which is *not* a function?
- (1) $x^2 + 2x + 1 = y$
 - (2) $y = \sin x$
 - (3) $x^2 + y^2 = 16$
 - (4) $y = \tan x$
- 217 1970_06_EY_26 Conics
The graph of the equation $4x^2 - 100 = 25y^2$ is
- (1) a hyperbola
 - (2) a circle
 - (3) an ellipse
 - (4) a parabola
- 218 1970_06_EY_27 Trigonometric Identities
Which expression is equivalent to $\frac{b \sin 2x}{\sin x}$?
- (1) $2b$
 - (2) $2b \sin x$
 - (3) $2b \cos x$
 - (4) $\sin x$

- 219 1970_06_EY_28 Logarithms
The expression $2\log x - \log y$ is equal to
- (1) $\log \frac{x^2}{y}$
 - (2) $\log \frac{2x}{y}$
 - (3) $\frac{\log x^2}{\log y}$
 - (4) $\frac{\log 2 + \log x}{\log y}$
- 220 1970_06_EY_29 Rationals: Undefined
Because of the restrictions on the domain of the relation defined by $f(x) = \frac{3}{x-3} - \frac{1}{x}$, which of the following can *not* be a subset of the domain?
- (1) $\{1\}$
 - (2) $\{0, 3\}$
 - (3) $\{\text{all irrationals}\}$
 - (4) $\{ \}$
- 221 1970_06_EY_30 Trigonometry: Law of Sines - The Ambiguous Case
Using the data angle $A=35^\circ$, $b=3$, and $a=4$, it is possible to construct
- (1) two distinct triangles
 - (2) a right triangle, only
 - (3) no triangles
 - (4) an obtuse triangle, only
- 222 1970_06_EY_31 Quadratics: $a > 1$
a Find to the *nearest tenth* the roots of the equation $2x^2 + 2x - 1 = 0$ [8]
b If in part *a*, $x = \csc \theta$, determine the quadrant (s) in which angle θ lies. [2]
- 223 1970_06_EY_32 Trigonometric Graphs
a. Sketch and label the graph of $y = \sin x$ as x varies from 0 to 2π radians. [3]
b. On the same set of axes sketch and label the graph of $y = \cos 2x$ as x varies from 0 to 2π radians. [5]
c. From *a* and *b*, determine the number of values of x between 0 and 2π radians that satisfy the equation $\sin x = \cos 2x$. [2]
- 224 1970_06_EY_33 Systems: Writing
Write an equation or a system of equations that can be used to solve *each* of the following problems. In each case state what the variable or variables represent. [Solution of the equation is not required.]
- a. A two digit number is 16 less than 3 times the number obtained by reversing the digits. The tens digit is 2 more than twice the units digit. Find the original number. [5]
 - b. Around the outside of a picture, whose length is 2 inches more than its width, is a border of uniform width of 3 inches. If the area of the border is 72 square inches, what are the dimensions of the picture? [5]
- 225 1970_06_EY_34 Trigonometric Functions: Logarithms of
Using logarithms, compute the value of N to the *nearest hundredth*: [10]
- $$N = \frac{(5.12)\sqrt{\cos 12^\circ 50'}}{\sqrt[3]{7.29}}$$
- 226 1970_06_EY_35a Trigonometry: Law of Cosines
Two straight roads RT and ST intersect at a town T and form with each other an acute angle of 67° . Towns at R and S are 22 miles and 31 miles respectively from T . Find to the *nearest mile* the distance between towns R and S . [4,6]
- 227 1970_06_EY_35b Trigonometry: Finding Sides Using Two Triangles
A man at one point on the street finds that the angle of elevation of the top of a tower is $29^\circ 50'$. After walking toward the tower for 200 feet in a straight line, he finds that at the second point the angle of elevation of the top of the tower is $65^\circ 20'$. What is the height of the tower to the *nearest foot*? [10]

- 228 1970_06_EY_36 Trigonometric Formulas: Derivations of
- a. Starting with the formulas for $\sin \frac{1}{2} \theta$ and $\cos \frac{1}{2} \theta$, derive a formula for $\tan \frac{1}{2} \theta$ in terms of $\cos \theta$. [Assume θ is an angle in the first quadrant.] [5]
- b. For all values of x for which the expression is defined, show that the following equality is an identity:

$$\frac{\sin x + \tan x}{1 + \sec x} = \sin x$$
 [5]

- 229 1970_06_EY_37 Systems: Other Nonlinear
- a. Solve the following system of inequalities graphically: [8]

$$x^2 + y^2 < 16$$

$$y \geq x + 2$$
- b. State the coordinates of two points which lie in the region representing the solution set. [2]
**This question is based on an optional topic in the syllabus.*

- 230 1970_08_EY_01 Equations and Expressions: Using Substitution in
- Given $h = \frac{t^2 + w^2}{3w}$. When $h = 5$ and $w = 2$, the positive value of t is
- (1) $2\sqrt{13}$
 - (2) $2\sqrt{6}$
 - (3) $2\sqrt{26}$
 - (4) 26

- 231 1970_08_EY_02 Inequalities: Linear
- Which is the solution set pictured in the graph?



- (1) $\{x \mid -1 \leq x \leq 2\}$
- (2) $\{x \mid -1 \leq x < 2\}$
- (3) $\{x \mid -1 < x < 2\}$
- (4) $\{x \mid -1 < x \leq 2\}$

- 232 1970_08_EY_03 Radicals: Rationalizing Denominators
- The fraction $\frac{\sqrt{3} - \sqrt{2}}{\sqrt{2}}$ is equivalent to

- (1) $\sqrt{3}$
- (2) $\frac{\sqrt{6} - 2}{2}$
- (3) $\frac{\sqrt{3} - 2}{2}$
- (4) $\sqrt{3} - 1$

- 233 1970_08_EY_04 Trigonometric Identities
- For all values of A for which the expression is defined, the product of $\tan A \cdot \cos A \cdot \csc A$ is equal to
- (1) 1
 - (2) $\frac{1}{2}$
 - (3) $\sin A$
 - (4) $\frac{1}{\sin A}$

- 234 1970_08_EY_05 Functions: Compositions of
- If $f(x) = x - 10$ and $g(x) = 10 - 2x$ and $f(x) = g(x) + 10$, then x is
- (1) 1
 - (2) 10
 - (3) -1
 - (4) -10

- 235 1970_08_EY_06 Equations and Expressions: Modeling
- A tank contains 20 pounds of salt water solution of which 6 pounds is salt. If x pounds of water are evaporated from this solution, what part of the remaining solution is salt?

- (1) $\frac{6-x}{20-x}$
- (2) $\frac{6}{20}$
- (3) $\frac{6}{20-x}$
- (4) $\frac{6-x}{20}$

236 1970_08_EY_07 Quadratics: Imaginary Solutions
A root of the quadratic equation $x^2 + 4 = 0$ is

- (1) i
- (2) $2i$
- (3) $1 - 2i$
- (4) $4i$

237 1970_08_EY_08 Trigonometric Equations
For what value of x in the interval $180^\circ \leq x \leq 360^\circ$ is $\sin x = \cos x$?

- (1) 180°
- (2) 225°
- (3) 270°
- (4) 360°

238 1970_08_EY_09 Systems: Quadratic Linear
Which ordered pair is in the intersection of $x - y = 2$ and $y^2 - 2x = 4$?

- (1) $(0, 2)$
- (2) $(-2, 0)$
- (3) $(10, 8)$
- (4) $(6, 4)$

239 1970_08_EY_10 Sets: Replacement
If the replacement set is the set of real numbers, then the solution set for $|3x - 2| = 1$ is

- (1) $\{1\}$
- (2) $\left\{\frac{1}{3}\right\}$
- (3) $\left\{1, \frac{1}{3}\right\}$
- (4) $\{ \}$

240 1970_08_EY_11 Functions: Domain and Range
If the domain of $y = x + 2$ is the set of positive integers, then the range consists of

- (1) only the positive integers greater than 2
- (2) all the positive integers
- (3) all the real numbers
- (4) all the negative integers

241 1970_08_EY_12 Trigonometric Functions: Evaluating
If x is a positive acute angle and $\tan x = R$, then $\cos x$ is equal to

- (1) $\frac{R}{\sqrt{R^2 - 1}}$
- (2) $\sqrt{R^2 - 1}$
- (3) $\frac{R}{\sqrt{R^2 + 1}}$
- (4) $\frac{1}{\sqrt{R^2 - 1}}$

242 1970_08_EY_13 Trigonometric Functions: Evaluating
If $\sin x = \frac{5}{13}$ and x is an angle in the first quadrant, the numerical value of $\sin(180^\circ - x)$ is

- (1) $\frac{12}{13}$
- (2) $-\frac{12}{13}$
- (3) $\frac{5}{13}$
- (4) $-\frac{5}{13}$

243 1970_08_EY_14 Trigonometric Equations
A root of the equation $\cos x = -\frac{\sqrt{3}}{2}$ is

- (1) 330°
- (2) 150°
- (3) 120°
- (4) 60°

244 1970_08_EY_15 Trigonometric Identities
For all values of x for which the expression is defined, $\frac{2\cos x}{\sin 2x}$ is equivalent to

- (1) $\sin x$
- (2) $2 \sin x$
- (3) $2 \csc x$
- (4) $\csc x$

- 245 1970_08_EY_16 Trigonometry: Law of Sines
Using the data $a=18$, $b=20$, and $A=60^\circ$, triangle ABC
- (1) must be a right triangle
 - (2) must be an acute triangle
 - (3) must be an obtuse triangle
 - (4) may be either an acute or an obtuse triangle

- 246 1970_08_EY_17 Trigonometric Graphs
Find the amplitude of the graph of $y = 3\sin 2x$.

- 247 1970_08_EY_18 Scientific Notation
If 2.6×10^n is equal to 0.00026, what is the value of n ?

- 248 1970_08_EY_19 Quadratics: Sum and Product of Roots
What is the sum of the roots of the equation $2x^2 - 3x = 5$?

- 249 1970_08_EY_20 Trigonometric Functions: Inverses of
If $\tan \theta = \frac{1}{4}$, express θ in inverse trigonometric form.

- 250 1970_08_EY_21 Polynomials: Factoring
Express $a^2 + a - 3(a + 1)$ as a product of two binomials.

- 251 1970_08_EY_22 Triangles: Special Right
If, in $\triangle ABC$, $\angle A = 45^\circ$, $\angle B = 45^\circ$, and $a = 3$, find the area of the triangle.

- 252 1970_08_EY_23 Variation: Inverse
According to Boyle's law, the volume of a gas, at a constant temperature, varies inversely with pressure applied to it. If the volume of a gas is 120 cubic inches when the pressure is 30 pounds per square inch, find the volume in cubic inches when the pressure is 40 pounds per square inch.

- 253 1970_08_EY_24 Trigonometry: Law of Sines
In $\triangle ABC$, $a = \sqrt{2}$, $b = 3$, and $B = 45^\circ$. Find the numerical value of $\sin A$.

- 254 1970_08_EY_25 Fractions: Complex
Express in *simplest* form:

$$\frac{\frac{x}{y} + z}{\frac{x}{z} + y}$$

- 255 1970_08_EY_26 Exponential Functions and Equations
Solve for x : $2^x - 10 = 6$

- 256 1970_08_EY_27 Logarithms
Find the value of N to the *nearest hundredth*, when $\log N = 1.6697$.

- 257 1970_08_EY_28 Circles: Arc Measure
In a circle with radius 2 inches, find the length of an arc, in inches, intercepted by a central angle of $2\frac{1}{2}$ radians.

- 258 1970_08_EY_29 Slope Intercept Form of a Line
Write an equation of the line drawn on the set of coordinate axes.

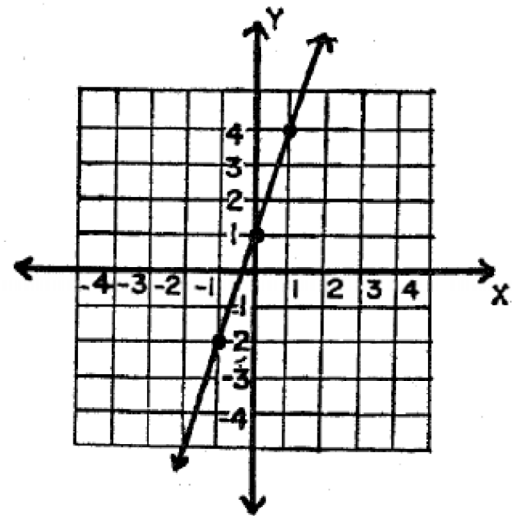

- 259 1970_08_EY_30 Trigonometry: Law of Cosines
In triangle ABC, $a = 2$, $b = 3$, and $\cos C = \frac{1}{3}$. Find the value of c .

- 260 1970_08_EY_31 Trigonometric Equations
a Find to the *nearest hundredth* the values of $\tan \theta$ in the solution set of
 $\left\{ \tan \theta \mid 2 \tan^2 \theta = 5 - \tan \theta \right\}$. [8]
b Using the result found in part *a*, determine the number of values of θ in the interval $0^\circ < \theta < 180^\circ$ which satisfy $2 \tan^2 \theta = 5 - \tan \theta$. [2]
- 261 1970_08_EY_32 Systems: Quadratic Linear
 Solve the following system of equations and *check* your solutions in both equations: [8,2]
 $3x^2 + y^2 + 1 = 0$
 $2x - y = 1$
- 262 1970_08_EY_33 Trigonometric Graphs
a On the same set of axes sketch the graphs of $y = \tan x$ and $y = 2 \cos x$ for values of x in the interval $0 \leq x \leq 2\pi$. [Label each curve with its equation.] [4,4]
b For how many values of x in the interval $0 \leq x \leq 2\pi$ is $y = 2 \cos x - \tan x$ undefined? [2]
- 263 1970_08_EY_34 Trigonometric Formulas: Derivations of
a Starting with the formula for $\tan(x + y)$ *derive* the formula for $\tan 2x$. [3]
b For all values of x for which the expression is defined, show that the following equation is an identity: [5]
 $1 + \frac{1}{\cos x} - \frac{\tan^2 x}{\sec x - 1}$
c For what value(s) of x in the interval $0 \leq x \leq \pi$ is the expression $1 + \frac{1}{\cos x} - \frac{\tan^2 x}{\sec x - 1}$ *not* defined? [2]
- 264 1970_08_EY_35 Systems: Writing
 A motorist can decrease by 2 hours the time it takes to travel 400 miles if he increases his average speed by 10 miles per hour. What was the motorist's original average speed in miles per hour? [Only an algebraic solution will be accepted.] [5,5]
- 265 1970_08_EY_36 Trigonometric Functions: Logarithms of
 Using logarithms, find to the *nearest degree* the value of x in the interval $0^\circ < x < 90^\circ$ if
 $\tan x = \sqrt{\frac{(3.75)(2.05)}{(8.25)(2.45)}} \cdot [10]$
- 266 1970_08_EY_37a Trigonometry: Law of Cosines
 Two sides of a parallelogram have lengths of 22 and 29. The measure of one angle of the parallelogram is 12° . Find to the *nearest tenth* the length of the shorter diagonal. [4,6]
- 267 1970_08_EY_37b Trigonometry: Finding Sides Using Two Triangles
 From a ship the angle of elevation of a point *A* at the top of a cliff is 21° . After the ship has sailed 1,250 feet directly toward the foot of the cliff, the angle of elevation is 47° . Find the height of the cliff to the *nearest ten feet*. [10]
- 268 1980_01_EY_01 Polynomials: Multiplication and Division of
 Simplify: $\frac{x^2 - 4x}{x^2 - 2x - 8}$
- 269 1980_01_EY_02 Rate, Time and Distance
 It took a sports reporter 3 hours and 15 minutes to drive 247 kilometers to Lake Placid. What was her average rate of speed in kilometers per hour for this trip?
- 270 1980_01_EY_03 Variation: Direct
 If x varies directly as y and $x = 6$ when $y = \frac{1}{3}$, find the value of x when $y = 3$.
- 271 1980_01_EY_04 Rationals: Solving
 Solve for R : $\frac{1}{R} = \frac{1}{2} + \frac{1}{3}$
- 272 1980_01_EY_05 Parallel and Perpendicular Lines
 Write an equation of the line which is perpendicular to $y = -\frac{3}{4}x + 7$ and which passes through the origin.

- 273 1980_01_EY_06 Trigonometric Functions: Evaluating
If $\cos A = \frac{5}{13}$ and $\tan A$ is negative, find the value of $\sin A$.
- 274 1980_01_EY_07 Trigonometry: Law of Cosines
In $\triangle ABC$, $a = 1$, $b = 2$, and $\cos C = \frac{1}{2}$. Find the length of side c in radical form.
- 275 1980_01_EY_08 Circles: Radian Measure
Express 165° in radian measure.
- 276 1980_01_EY_09 Systems: Linear
Solve the following system of equations for y in terms of a and b :
 $x + y = a$
 $x - y = b$
- 277 1980_01_EY_10 Logarithms
If $n = 7.21 \times 10^2$, what is the numerical value of $\log n$?
- 278 1980_01_EY_11 Trigonometry: Law of Sines
In $\triangle ABC$, $\sin A = 0.2$, $\sin B = 0.3$, and $a = 10$. What is the length of side b ?
- 279 1980_01_EY_12 Inequalities: Linear
What is the solution set of the inequality $3x + 1 \geq 11 - 2x$?
(1) $\{x \leq -2\}$
(2) $\{x \geq 2\}$
(3) $\{x \geq -2\}$
(4) $\{x > 0\}$
- 280 1980_01_EY_13 Numbers: Imaginary
The expression $\sqrt{-8}$ is equivalent to
(1) $i\sqrt{2}$
(2) $2i$
(3) $2i\sqrt{2}$
(4) $4i\sqrt{2}$
- 281 1980_01_EY_14 Scientific Notation
The expression $\frac{6 \times 10^8}{3 \times 10^2}$ is equal to
(1) 2×10^6
(2) 2×10^4
(3) 2×10^{-6}
(4) 2×10^{-4}
- 282 1980_01_EY_15 Numbers: Properties of Real
Which equation is an illustration of the distributive law?
(1) $a(b + c) = ab + ac$
(2) $(a + b) + c = a + (b + c)$
(3) $(ab)c = a(bc)$
(4) $ab + ac = ac + ab$
- 283 1980_01_EY_16 Trigonometric Graphs
What is the amplitude of the function $y = 3 \sin 2x$?
(1) π
(2) 2
(3) 3
(4) $\frac{2\pi}{3}$
- 284 1980_01_EY_17 Conics
The graph of the equation $3y^2 = 6 - x^2$ is
(1) a circle
(2) an ellipse
(3) a parabola
(4) a hyperbola
- 285 1980_01_EY_18 Equations: Logarithmic
If $\log_{10}(x + 5) = 1$, what is the value of x ?
(1) 1
(2) 5
(3) 10
(4) 0

286 1980_01_EY_19 Quadratics: Noninteger Solutions
One root of the equation $6x^2 - 11x + 5 = 0$ is 1.
What is the other root?

- (1) $\frac{2}{5}$
- (2) $\frac{1}{2}$
- (3) $\frac{4}{3}$
- (4) $\frac{5}{6}$

287 1980_01_EY_20 Slope Intercept Form of a Line
Which statement is true concerning the graph of the equation $y = x$?

- (1) It is parallel to the x-axis.
- (2) It is perpendicular to the x-axis.
- (3) It has no slope.
- (4) It passes through the origin.

288 1980_01_EY_21 Functional Notation
If $f(x) = \frac{1}{2}(x-3)^2$, the value of $f(3)$ is

- (1) 1
- (2) $\frac{1}{2}$
- (3) 0
- (4) $\frac{9}{2}$

289 1980_01_EY_22 Trigonometric Functions: Evaluating
The value of $\sin(\text{Arc csc } 2)$ is

- (1) 1
- (2) 2
- (3) $\frac{1}{2}$
- (4) $\frac{1}{4}$

290 1980_01_EY_23 Factors: Prime
The prime factors of $2x^3 + x^2 - 6x$ are

- (1) $(2x^2 + 3x)(x - 2)$
- (2) $x(2x - 3)(x + 2)$
- (3) $x(2x + 3)(x - 2)$
- (4) $x^2(2x + 1)(-6x)$

291 1980_01_EY_24 Radicals: Operations with
The expression $(\sqrt[4]{2})(\sqrt[4]{24})$ is equal to

- (1) $\sqrt[4]{6}$
- (2) $2\sqrt[4]{3}$
- (3) $3\sqrt{6}$
- (4) $4\sqrt{3}$

292 1980_01_EY_25 Trigonometry: Reference Angles
The expression $\sin(-110^\circ)$ is equivalent to

- (1) $\sin 20^\circ$
- (2) $\cos 20^\circ$
- (3) $-\sin 70^\circ$
- (4) $-\cos 70^\circ$

293 1980_01_EY_26 Numbers: Complex
If $(x + 3) + (y + 2)i = 7 - 6i$, what is the value of x ?

- (1) 10
- (2) 7
- (3) -4
- (4) 4

294 1980_01_EY_27 Trigonometric Functions: Evaluating
The numerical value of $\cot 330^\circ$ is

- (1) $\frac{\sqrt{3}}{3}$
- (2) $-\frac{\sqrt{3}}{3}$
- (3) $\sqrt{3}$
- (4) $-\sqrt{3}$

295 1980_01_EY_28 Trigonometric Equations
Which value of x satisfies the equation $2\cos^2 x - 1 = 1$?

- (1) 0°
- (2) 30°
- (3) 45°
- (4) 90°

- 296 1980_01_EY_29 Trigonometric Identities
The expression $\frac{\tan x}{\sec^2 x}$ is equivalent to
- (1) $\sin x$
 - (2) $\sin x \cos x$
 - (3) $\frac{\sin^3 x}{\cos x}$
 - (4) $\frac{\cos^3 x}{\sin x}$
- 297 1980_01_EY_30 Trigonometric Identities
The expression $\frac{1}{1 - \cos A} + \frac{1}{1 + \cos A}$ is equivalent to
- (1) $\frac{2}{1 + \cos A}$
 - (2) $\frac{2}{1 - \cos A}$
 - (3) $\frac{2}{1 - \cos^2 A}$
 - (4) $\frac{2 \cos A}{1 - \cos^2 A}$
- 298 1980_01_EY_31 Quadratics: $a > 1$
- a. Find to the nearest tenth the roots of the equation $4x^2 - 3x - 5 = 0$. [8]
 - b. If $x = \sin \theta$, determine the quadrant(s) in which angle θ may lie. [2]
- 299 1980_01_EY_32 Trigonometric Graphs
- a. On the same set of axes, sketch the graphs of $y = 2 \sin x$ and $y = \cos 2x$ for the values of x in the interval $0 \leq x \leq 2\pi$. [Label each graph with its equation.] [4,4]
 - b. From the graphs sketched in part a, find one value of x in the interval $0 \leq x \leq 2\pi$ such that $2 \sin x > \cos 2x$. [2]
- 300 1980_01_EY_33 Systems: Quadratic Linear
The perimeter of a rectangle is 28 centimeters. If the diagonal of the rectangle is 10 centimeters, find the number of centimeters in the length and width of the rectangle. [Only an algebraic solution will be accepted.] [4,6]
- 301 1980_01_EY_34 Trigonometry: Law of Cosines
In triangular field RST , the length of \overline{RS} is 50 meters, the measure of angle RST is 142° , and the length of \overline{ST} is 68 meters. Find the length of \overline{RT} to the nearest meter. [10]
- 302 1980_01_EY_35 Trigonometric Formulas: Derivations of
- a. Starting with the formula for $\cos(x + y)$, derive the formula for $\cos 2x$ in terms of $\sin x$. [4]
 - b. For all values of A for which the expressions are defined, prove that $(\sin A + 1)(\csc A - 1) = \cos A \cot A$ is an identity. [6]
- 303 1980_01_EY_36a Exponential Functions and Equations
Solve for x : $4^{3x-1} = 32^x$ [3]
- 304 1980_01_EY_36b Trigonometric Functions: Logarithms of
- b. If $n = \sqrt[3]{\frac{A^2}{B \cos \theta}}$, write an equation for $\log n$ in terms of $\log A$, $\log B$, and $\log \cos \theta$. [4]
- 305 1980_01_EY_36c Equations: Logarithmic
Using logarithms, find n to the nearest hundredth if $n = \sqrt[3]{432}$ [3]
- 306 1980_01_EY_37 Systems: Other Nonlinear
- a. On the same set of axes, graph the following system of inequalities:
 $x^2 + y^2 < 16$ [8]
 $y \geq x$
 - b. Give the coordinates of one point in the graph of the solution set of the system in part a. [2]
- * This question is based on an optional topic in the syllabus.

307 1980_06_EY_01 Numbers: Complex

The sum of $\sqrt{-2}$ and $\sqrt{-18}$ is

- (1) $6i$
- (2) $2i\sqrt{5}$
- (3) $5i\sqrt{2}$
- (4) $4i\sqrt{2}$

308 1980_06_EY_02 Rationals: Solving

What is the solution set of the equation

$$\frac{1}{15} + \frac{1}{10} = \frac{1}{x}?$$

- (1) $\{12.5\}$
- (2) $\{25\}$
- (3) $\{3\}$
- (4) $\{6\}$

309 1980_06_EY_03 Logarithms

If $x = \frac{a\sqrt{b}}{c}$, the $\log x$ is equal to

- (1) $\log a + \frac{1}{2} \log b - \log c$
- (2) $\log a + 2 \log b - \log c$
- (3) $\log a - \frac{1}{2} \log b + \log c$
- (4) $\log a - 2 \log b - \log c$

310 1980_06_EY_04 Graphs: Identifying Equations of

Which is an equation of the quadratic function shown in the accompanying graph?

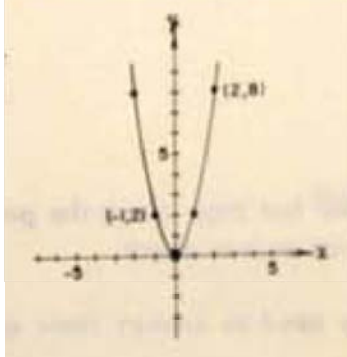

- (1) $y = \frac{1}{2}x^2$
- (2) $y = -\frac{1}{2}x^2$
- (3) $y = 2x^2$
- (4) $y = -2x^2$

311 1980_06_EY_05 Consecutive Integers

If the product of two consecutive integers is 0, one of the integers may be

- (1) 1
- (2) 2
- (3) 3
- (4) 4

312 1980_06_EY_06 Trigonometric Identities

The function $\sin \frac{9\pi}{4}$ has the same value as

- (1) $\sin 90^\circ$
- (2) $\sin 60^\circ$
- (3) $\sin 45^\circ$
- (4) $\sin 30^\circ$

313 1980_06_EY_07 Trigonometric Graphs

What is the amplitude of the graph of $y = 2 \sin \frac{1}{2}x$

- (1) 1
- (2) 2
- (3) $\frac{1}{2}$
- (4) 4

314 1980_06_EY_08 Exponents

What is the numerical value of $3^{-1} + 4^{-1}$?

- (1) $\frac{1}{7}$
- (2) 7^{-2}
- (3) $\frac{1}{12}$
- (4) $\frac{7}{12}$

315 1980_06_EY_09 Exponential Functions and Equations

The solution set of $2^{x^2+2x} = 2^{-1}$ is

- (1) $\{1\}$
- (2) $\{-1\}$
- (3) $\{1,-1\}$
- (4) $\{ \}$

- 316 1980_06_EY_10 Trigonometric Equations
Which value of B is in the solution set of the equation $\sin B = 0$?
- (1) $\frac{\pi}{6}$
 - (2) $\frac{\pi}{2}$
 - (3) $\frac{\pi}{3}$
 - (4) $\frac{\pi}{4}$
- 317 1980_06_EY_11 Inequalities: Absolute Value
Which represents the solution set for x in the inequality $|2x - 1| < 7$?
- (1) $\{x|x < -3 \text{ or } x > 4\}$
 - (2) $\{x|x < -4 \text{ or } x > 3\}$
 - (3) $\{x|x < -3 \text{ or } x < 4\}$
 - (4) $\{x|x < -4 \text{ or } x > 3\}$
- 318 1980_06_EY_12 Trigonometric Equations
If $\sin(A - 30)^\circ = \cos 60^\circ$, the number of degrees in the measure of angle A is
- (1) 30
 - (2) 60
 - (3) 90
 - (4) 120
- 319 1980_06_EY_13 Trigonometric Identities
The expression $(\cot \theta)(\sec \theta)$ is equivalent to
- (1) $\csc \theta$
 - (2) $\sin \theta$
 - (3) $\cos \theta$
 - (4) $\tan \theta$
- 320 1980_06_EY_14 Equations and Expressions: Using Substitution in
Given the equation $x^2 + bx + x + b = 0$
One value of x which satisfies the equation is $x = -b$. Which is another value of x that satisfies the equation?
- (1) 1
 - (2) 2
 - (3) -1
 - (4) -2
- 321 1980_06_EY_15 Radicals: Operations with
If b is a positive real number, then $\frac{b}{\sqrt{b}}$ is equivalent to
- (1) 1
 - (2) $\frac{1}{\sqrt{1}}$
 - (3) $\frac{1}{\sqrt{b}}$
 - (4) \sqrt{b}
- 322 1980_06_EY_16 Trigonometric Functions: Properties of
If $\sin \theta = \frac{1 - \sqrt{17}}{4}$, then angle θ lies in which quadrants?
- (1) I and II, only
 - (2) II and IV, only
 - (3) III and IV, only
 - (4) I, II, III, and IV
- 323 1980_06_EY_17 Variation: Direct
If x varies directly with y , then when x is
- (1) multiplied by 2, y is multiplied by 2
 - (2) multiplied by 2, y is divided by 2
 - (3) increased by 2, y is increased by 2
 - (4) increased by 2, y is decreased by 2
- 324 1980_06_EY_18 Quadratics: Using the Discriminant
Which value of k will make the roots of the equation $x^2 + 2kx + 16 = 0$ real, rational, and equal?
- (1) $-2\sqrt{2}$
 - (2) 2
 - (3) $4\sqrt{2}$
 - (4) -4
- 325 1980_06_EY_19 Functions: Domain and Range
What is the domain of the function $f(x) = \sqrt{x - 2}$?
- (1) $\{x|x \geq 0\}$
 - (2) $\{x|x \geq 2\}$
 - (3) $\{x|x \leq 2\}$
 - (4) $\{x|x \geq -2\}$

- 326 1980_06_EY_20 Trigonometry: Law of Cosines
In triangle ABC , $a = 2$, $b = 3$, and $c = 4$. What is the value of $\cos C$?
- (1) $-\frac{1}{16}$
 - (2) $\frac{1}{16}$
 - (3) $-\frac{1}{4}$
 - (4) $\frac{1}{4}$
- 327 1980_06_EY_21 Exponential Functions and Equations
If $f(x) = x^{\frac{2}{3}}$, find $f(-27)$.
- 328 1980_06_EY_22 Polynomials: Factoring
Factor completely: $6t^2 - 7t - 3$
- 329 1980_06_EY_23 Numbers: Complex
What is the additive inverse of $2-3i$?
- 330 1980_06_EY_24 Trigonometry: Law of Sines
In triangle ABC , $\sin A = 0.8$, $\sin B = 0.3$, and $a = 24$. Find the length of side b .
- 331 1980_06_EY_25 Circles: Radian Measure
Express 72° in radian measure. [Answer may be left in terms of π .]
- 332 1980_06_EY_26 Systems: Other Nonlinear
Solve the following system of equations for x in terms of a and b , where $a \neq 0$ and $b \neq 0$.
- $$ax + y = b$$
- $$2ax + y = 2b$$
- 333 1980_06_EY_27 Trigonometric Functions: Evaluating
If $\sin x = \frac{3}{5}$, what is the value of $\cos 2x$?
- 334 1980_06_EY_28 Trigonometric Functions: Inverses of
If $\theta = \text{Arc cos} \left(\frac{\sqrt{3}}{2} \right)$, what is the measure of angle θ ?
- 335 1980_06_EY_29 Parallel and Perpendicular Lines
What is the slope of a line that is perpendicular to the line which passes through the points $(0,0)$ and $(5,5)$?
- 336 1980_06_EY_30 Trigonometric Functions: Evaluating
Find the value of $\cos 55^\circ 23'$.
- 337 1980_06_EY_31 Quadratics: Noninteger Solutions
- a. Find to the nearest tenth the roots of the equation $3x = 2 + \frac{2}{x}$. [8]
 - b. If $x = \sin \theta$, use the answers obtained in part a to determine the quadrant(s) in which angle θ may lie. [2]
- 338 1980_06_EY_32 Trigonometric Formulas: Derivations of
- a. Starting with the formulas for $\sin(A - B)$ and for $\cos(A - B)$, derive the formula for $\tan(A - B)$ in terms of $\tan A$ and $\tan B$. [5]
 - b. For all values of B for which the expressions are defined, prove the following is an identity:
$$\tan(45^\circ - B) = \frac{\cos B - \sin B}{\cos B + \sin B}$$
 [5]
- 339 1980_06_EY_33 Systems: Writing
A shopkeeper bought a shipment of identical dresses for a total \$800. She sold all but 4 of the dresses for \$10 more than each dress cost her, and had total receipts of \$980. How many dresses were in the original shipment? [Only an algebraic solution will be accepted.] [5,5]
- 340 1980_06_EY_34 Equations: Logarithmic
- a. The volume of a cylinder is found by the formula $V = \pi r^2 h$. If the volume (V) equals 142 and the radius (r) equals 5.2, use logarithms to find h to the nearest tenth. [Use $\pi = 3.14$.] [8]
 - b. The graph of $y = \log_2 x$ lies in quadrants [2]
 - (1) I and II, only
 - (2) II and III, only
 - (3) III and IV, only
 - (4) I and IV, only

- 341 1980_06_EY_35 Trigonometry: Law of Cosines
- Two consecutive sides of a parallelogram are 8 centimeters and 10 centimeters long, respectively. If the length of the longer diagonal of the parallelogram is 14 centimeters, find the measure of the largest angle of the parallelogram to the nearest degree. [7]
 - Using your answer to part a, find the area of the parallelogram to the nearest square centimeter. [3]
- 342 1980_06_EY_36 Trigonometric Graphs
- On the same set of axes, sketch the graphs of $y = 2 \sin x$ and $y = \cos \frac{1}{2}x$ as x varies from 0 to 2π radians. [8]
 - State the number of values of x in the interval $0 \leq x \leq 2\pi$ that satisfy the equation $2 \sin x = \cos \frac{1}{2}x$. [2]
- 343 1980_06_EY_37 Inequalities: Systems of
- On a graph, indicate the solution set of $\left\{ \begin{array}{l} (x, y)xy \geq 12 \text{ and } x - 2y < 2 \end{array} \right\}$ [8]
 - From your graph in part a, give the coordinates of a point which does *not* satisfy either inequality. [2]
- * This question is based on an optional topic in the syllabus.
- 344 1980_08_EY_01 Scientific Notation
- If the number 0.0031 is written in the form 3.1×10^n , then n is equal to
- $\frac{1}{3}$
 - 2
 - 3
 - 3
- 345 1980_08_EY_02 Numbers: Imaginary
- What is the solution set for $\left| x^2 \right| = -1$?
- 346 1980_08_EY_03 Conics
- The graph of the relation $x^2 - \frac{y^2}{16} = 1$ is
- a circle
 - a hyperbola
 - an ellipse
 - a parabola
- 347 1980_08_EY_04 Trigonometric Equations
- Which value of x will satisfy the equation $\sin^2 x - 1 = 0$?
- 30°
 - 45°
 - 60°
 - 90°
- 348 1980_08_EY_05 Trigonometric Functions: Evaluating
- What is the numerical value of $6 \sin \frac{5\pi}{6}$?
- 1
 - $3\sqrt{3}$
 - 3
 - 3
- 349 1980_08_EY_06 Numbers: Properties of Real
- Which is a member of the set of rational numbers?
- i^2
 - $2i$
 - $3 + 2\sqrt{2}$
 - $\frac{2 + 3\sqrt{2}}{3}$
- 350 1980_08_EY_07 Radicals: Rationalizing Denominators
- The expression $\frac{\sqrt{2} + 1}{\sqrt{2} - 1}$ is equivalent to
- $\frac{\sqrt{2}}{3}$
 - $2 - 3\sqrt{2}$
 - $3 + 2\sqrt{2}$
 - $\frac{2 + 3\sqrt{2}}{3}$

351 1980_08_EY_08 Systems: Quadratic Linear
 The graphs of $x^2 + y^2 = 9$ and $y = -3$ are drawn on the same set of axes. How many points do these graphs have in common?

- (1) 1
- (2) 2
- (3) 0
- (4) 4

352 1980_08_EY_09 Fractions: Complex

What is the value of the expression $2 - \frac{1}{x}$ when

$x = \frac{3}{2}$?

- (1) $\frac{1}{6}$
- (2) $\frac{2}{3}$
- (3) $\frac{3}{8}$
- (4) $\frac{1}{4}$

353 1980_08_EY_10 Systems: Other Nonlinear
 Which value of B satisfies the following system of equations?

$\sin A + \cos B = 1$

$\sin A - \cos B = 0$

- (1) $B=30^\circ$
- (2) $B=45^\circ$
- (3) $B=60^\circ$
- (4) $B=90^\circ$

354 1980_08_EY_11 Trigonometric Identities

The expression $\frac{\sin^2 x + \cos^2 x}{\cos x}$ is equivalent to

- (1) $\sin x \cos x$
- (2) $\tan x \cos x$
- (3) $\csc x$
- (4) $\sec x$

355 1980_08_EY_12 Quadratics: Inequalities
 Which is the graph of the solution set of the inequality $x^2 - 4x - 5 < 0$?

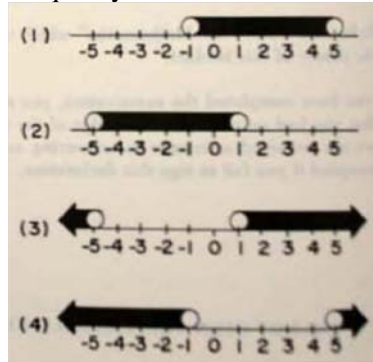

356 1980_08_EY_13 Polynomials: Factoring
 One factor of the expression $(a - 2)^2 + 3(a - 2)$ is

- (1) $a - 1$
- (2) $a - 5$
- (3) $a + 1$
- (4) $a + 2$

357 1980_08_EY_14 Trigonometric Functions: Properties of
 As an angle increases from $\frac{\pi}{2}$ to $\frac{3\pi}{2}$, its cosine will

- (1) increase, only
- (2) decrease, only
- (3) increase, then decrease
- (4) decrease, then increase

358 1980_08_EY_15 Trigonometry: Law of Cosines
 In triangle ABC , $a = \sqrt{5}$, $b = \sqrt{5}$, and $c = 2$.
 What is the value of $\cos C$?

- (1) $\frac{3}{5}$
- (2) 0
- (3) $-\frac{3}{10}$
- (4) $-\frac{1}{4}$

359 1980_08_EY_16 Trigonometric Identities
 The value of $\sin(-10^\circ)$ is equivalent to the value of

- (1) $\sin(10^\circ)$
- (2) $-\sin(10^\circ)$
- (3) $-\cos(10^\circ)$
- (4) $\csc(10^\circ)$

- 360 1980_08_EY_17 Trigonometric Equations
Which value of x satisfies the equation $\cos(3x - 10^\circ) = \sin(x + 20^\circ)$?
(1) 15°
(2) 20°
(3) 35°
(4) 50°
- 361 1980_08_EY_18 Trigonometric Identities: Angle Sum or Difference
If $\sin A = \frac{3}{5}$ and $\sin B = \frac{4}{5}$, what is the value of $\sin(A + B)$?
- 362 1980_08_EY_19 Variation: Direct
If y varies directly as the square root of x , and $y = 32$ when $x = 4$, find the value of y when $x = 5$.
- 363 1980_08_EY_20 Systems: Writing
The sum of the digits of a two-digit number is 9. If the number is divided by the sum of the digits, the quotient is 3. What is the number?
- 364 1980_08_EY_21 Trigonometric Functions: Inverses of
If $B = \text{Arc cos}(0.7071)$, what is the measure of angle B ?
- 365 1980_08_EY_22 Equations: Forming Quadratics from Roots
If 5 is a root of the equation $ax^2 - 10x - 25 = 0$, find the value of a .
- 366 1980_08_EY_23 Quadratics: Using the Discriminant
Find the numerical value of c that will make the roots of $x^2 - 6x + c = 0$ real, rational, and equal.
- 367 1980_08_EY_24 Equations: Literal
Given the equation $2x^2 - y = a$. If $x = \frac{1}{2}$, express y in terms of a .
- 368 1980_08_EY_25 Equations: Logarithmic
If $\log_{10}x = 2$, what is the value of x ?
- 369 1980_08_EY_26 Exponential Functions and Equations
Solve for x : $9^x = 27$
- 370 1980_08_EY_27 Trigonometry: Law of Sines
In triangle ABC , $a = 3$, $b = 5$, and $\sin B = \frac{1}{2}$. What is the value of $\sin A$?
- 371 1980_08_EY_28 Functional Notation
If $f(x) = \frac{2x^2 - x}{9}$, what is the numerical value of $f(1)$?
- 372 1980_08_EY_29 Numbers: Complex
Perform the indicated operations and express the result in *simplest form*: $(7i - 3) - 2(3i - 2)$
- 373 1980_08_EY_30 Circles: Arc Measure
In a circle, a central angle of 1.5 radians intercepts an arc of 4.5 centimeters. Find the number of centimeters in the length of the radius of the circle.
- 374 1980_08_EY_31 Trigonometric Equations
a. Find to the nearest tenth the values of $\tan x$ which satisfy the equation $\tan^2 x + 4 \tan x - 6 = 0$. [8]
b. Using the answers obtained in part a , determine the number of values of x in the interval $0 \leq x < 2\pi$ which satisfy the equation $\tan^2 x + 4 \tan x - 6 = 0$. [2]
- 375 1980_08_EY_32 Quadratics: Graphing
a. Draw the graph of the function $f(x) = x^2 - 4x + 2$ as x varies from -1 to +5 inclusive. [6]
b. Write an equation of the axis of symmetry. [2]
c. Find the minimum value of $x^2 - 4x + 2$. [2]

- 376 1980_08_EY_33 Trigonometry: Finding Area
- In quadrilateral $ABCD$, $m\angle DAB = 106$, $AB = 18$, $AD = 12$, $m\angle ACB = 56$, and $m\angle B = 90$.
Find AC to the nearest integer. [5]
 - Using the answer to part a, find the area of triangle ACD to the nearest integer. [5]

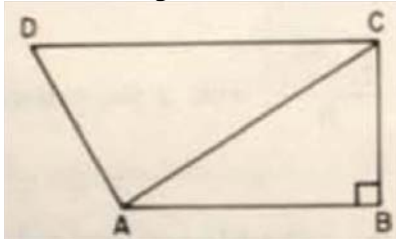

- 377 1980_08_EY_34 Trigonometric Graphs
- On the same set of axes, sketch the graphs of $y = \tan x$ and $y = \cos 2x$ for values of x in the interval $0 \leq x \leq \pi$. [4,4]
 - State the number of values of x in the interval $0 \leq x \leq \pi$ that satisfy the equation $\tan x = \cos 2x$. [2]

- 378 1980_08_EY_35a Trigonometric Formulas: Derivations of
- Starting with the formula for $\sin(x + y)$, derive the formula for $\sin 2x$. [4]

- 379 1980_08_EY_35b Logarithms
- If $\log_8 x = 1.2346$ and $\log_8 y = 2.1680$, find the value of

(1) $\log_8 xy^2$ [5]

(2) $\log_8 \frac{y}{\sqrt{x}}$ [5]

- 380 1980_08_EY_36 Systems: Writing
- A woman bought a certain number of shares of stock for \$900. If she had bought these shares one week earlier when the price per share was \$3 less, she could have bought 10 more shares for the same investment. How many shares did she buy? [Only an algebraic solution will be accepted.] [5,5]

- 381 1980_08_EY_37 Systems: Three Variables
- Solve the following system of equations and check
- $$x + y + 2z = 6 \quad [7,3]$$
- $$3x - y + 4z = 3$$
- $$3x + 2y - 6z = 20$$
- * This question is based on an optional topic in the syllabus.

EY - The Eleventh Year Curriculum (1990)

- 382 1990_01_EY_01 Scientific Notation
If the number 93,000,000 is written in the form 9.3×10^n , what is the value of n ?
- 383 1990_01_EY_02 Circles: Radian Measure
Express 140° in radian measure.
- 384 1990_01_EY_03 Exponential Functions and Equations
Solve for x : $2^{3x-2} = 4^{2x}$
- 385 1990_01_EY_04 Trigonometric Equations
If $f(x) = \cos 2x$, find $f(30^\circ)$
- 386 1990_01_EY_05 Fractions: Complex
Express in simplest form: $\frac{\frac{a}{4} - \frac{1}{2}}{\frac{a^2}{4} - 1}$
- 387 1990_01_EY_06 Parallel and Perpendicular Lines
Find the slope of a line parallel to the line whose equation is $2x + 3y = 6$.
- 388 1990_01_EY_07 Numbers: Complex
Express the product of $(3 - i)$ and $(3 + i)$ in simplest form.
- 389 1990_01_EY_08 Variation: Inverse
If x varies inversely as y and $x = 4$ when $y = 5$, find x when $y = 10$.
- 390 1990_01_EY_09 Systems: Writing
Phil is three times as old as Carrie. Five years ago, Phil was four times as old as Carrie was at that time. How old is Carrie now?
- 391 1990_01_EY_10 Radicals: Solving
Solve for x : $\sqrt{2x + 1} = 3$
- 392 1990_01_EY_11 Trigonometry: Law of Sines - The Ambiguous Case
What is the total number of distinct triangles that can be constructed if $m\angle A = 60$, $a = 9$, and $b = 10$.
- 393 1990_01_EY_12 Trigonometric Functions: Evaluating
Find the numerical value of the expression $\sin \frac{\pi}{2} + \tan \frac{\pi}{4}$.
- 394 1990_01_EY_13 Equations: Logarithmic
Find x if $\log_{16} x = \frac{3}{4}$.
- 395 1990_01_EY_14 Trigonometry: Finding Area
In $\triangle ABC$, $a = 20$, $b = 12$, and $m\angle C = 150$. Find the area of the triangle.
- 396 1990_01_EY_15 Trigonometric Equations
Find the positive acute angle that satisfies the equation $2 \sin^2 \theta + \sin \theta - 1 = 0$.
- 397 1990_01_EY_16 Circles: Radian Measure
Find the number of radians in a central angle that intercepts an arc of 28 centimeters in a circle whose radius is 7 centimeters.
- 398 1990_01_EY_17 Trigonometric Functions: Evaluating
If $\tan A = 1$, find the value of $\sin 2A$.
- 399 1990_01_EY_18 Quadratics: Sum and Product of Roots
What is the sum of the roots of the equation $2x^2 = x - 3$?
- (1) $\frac{1}{2}$
(2) $-\frac{1}{2}$
(3) $\frac{3}{2}$
(4) $-\frac{3}{2}$
- 400 1990_01_EY_19 Logarithms
If $\log 3 = x$ and $\log 5 = y$, then $\log 15$ is equal to
- (1) xy
(2) $\frac{x}{y}$
(3) $x + y$
(4) $x - y$

- 401 1990_01_EY_20 Functions: Domain and Range
In the system of real numbers, the domain of the relation $y = \frac{1}{\sqrt{x-1}}$ is
- (1) $\{x|x > 1\}$
 - (2) $\{x|x \geq 1\}$
 - (3) $\{x|x < 1\}$
 - (4) $\{x|x \leq 1\}$
- 402 1990_01_EY_21 Quadratics: Using the Discriminant
If a quadratic equation with real coefficients has a discriminant of 2, then its two roots must be
- (1) equal
 - (2) imaginary
 - (3) real and rational
 - (4) real and irrational
- 403 1990_01_EY_22 Trigonometric Identities
The value of $\cos(-60^\circ)$ is the same as the value of
- (1) $\cos 60^\circ$
 - (2) $-\cos 60^\circ$
 - (3) $\cos 30^\circ$
 - (4) $-\cos 30^\circ$
- 404 1990_01_EY_23 Systems: Other Nonlinear
In which quadrant(s) does the solution set of the system of equations $xy = 8$ and $y = x$ lie?
- (1) I, only
 - (2) III, only
 - (3) I and III
 - (4) II and IV
- 405 1990_01_EY_24 Circles: Equations of
Which is an equation of a circle?
- (1) $3x^2 = 3y - 16x$
 - (2) $xy = 3$
 - (3) $3x^2 = 6 + 3y^2$
 - (4) $3x^2 = 6 - 3y^2$
- 406 1990_01_EY_25 Equations: Literal
Given the formula $p = 2(l + w)$. Expressed in terms of p and w , l is equal to
- (1) $\frac{p-2w}{2}$
 - (2) $\frac{2w-p}{2}$
 - (3) $\frac{p}{w}$
 - (4) $p - w$
- 407 1990_01_EY_26 Trigonometry: Law of Cosines
In $\triangle RST$, $r = 3$, $s = 4$, and $m\angle T = 120$. The value of t is
- (1) 37
 - (2) $\sqrt{37}$
 - (3) 13
 - (4) $\sqrt{13}$
- 408 1990_01_EY_27 Trigonometric Graphs
What is the period of the graph of the equation $y = 2 \cos \frac{1}{2}x$?
- (1) $\frac{1}{2}$
 - (2) 2
 - (3) π
 - (4) 4π
- 409 1990_01_EY_28 Trigonometric Functions: Inverses of
The value of $\cos \left[\text{Arc sin} \left(\frac{2}{3} \right) \right]$ is
- (1) $\frac{5}{3}$
 - (2) $\frac{3}{13}$
 - (3) $\frac{\sqrt{5}}{3}$
 - (4) $\frac{3\sqrt{13}}{13}$

- 410 1990_01_EY_29 Inequalities: Linear
Which graph represents the solution set of the inequality $|2x + 1| < 7$?

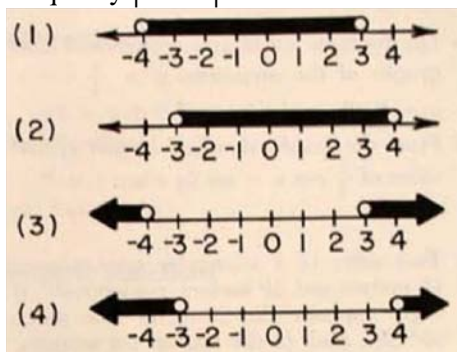

- 411 1990_01_EY_30 Trigonometric Graphs
As x increases from $-\frac{\pi}{2}$ to $\frac{\pi}{2}$ radians, the graph of the equation $y = \cos x$ will

- (1) decrease, then increase
- (2) increase, then decrease
- (3) increase throughout the interval
- (4) decrease throughout the interval

- 412 1990_01_EY_31 Quadratics: Noninteger Solutions
- a. Solve for all values of x to the *nearest tenth*:
 $2x^2 = 3(4x - 3)$ [8]
 - b. If, in the equation in part *a*, x is replaced with $\tan \theta$, in which quadrant(s) would angle θ lie? [2]

- 413 1990_01_EY_32 Trigonometric Graphs
- a. On the same set of axes, sketch and label the graphs of the equations $y = \frac{1}{2} \cos x$ and $y = \sin 2x$ in the interval $0 \leq x \leq 2\pi$. [8]
 - b. From the graphs sketched in part *a*, find the value of $\frac{1}{2} \cos x - \sin 2x$ when $x = 0$. [2]

- 414 1990_01_EY_33 Trigonometry: Law of Sines
- a. Two sides of a triangular garden measure 16 meters and 20 meters, respectively. If the angle opposite the 20-meter side measures $65^\circ 30'$, find, to the nearest ten minutes, the measure of the angle opposite the 16-meter side. [6]
 - b. Find the area of the garden to the nearest square meter. [4]

- 415 1990_01_EY_34 Systems: Other Nonlinear
Solve the following system of equations graphically:
 $x^2 + y^2 = 25$ [10]
 $4x - 3y = 0$

- 416 1990_01_EY_35 Systems: Writing
Harold and Alfred made arrangements for a summer bus trip to a Mets baseball game. The cost of the bus was \$600, to be shared equally by all participants. The day before the trip, five more people obtained tickets for the game and wanted to go on the bus. This reduced the cost per person for the bus by \$4. How many people were in the final group? [10]

- 417 1990_01_EY_36 Trigonometric Formulas: Derivations of
- a. Starting with the formula for $\sin(A + B)$, derive the formula for $\sin(A - B)$ [3]
 - b. Using the formula derived in part *a*, prove that $\sin(180^\circ - B) = \sin B$. [2]
 - c. For all values of x for which the expressions are defined, show that the following is an identity:
$$\frac{\sec x + \csc x}{\tan x + \cot x} = \sin x + \cos x$$
 [5]
- 418 1990_01_EY_37 Logarithms
- a. Using logarithms, find the value of $\sqrt[3]{0.351}$ to the *nearest thousandth*. [4]
 - b. If $\log 2 = x$ and $\log 7 = y$, express $\log \sqrt{\frac{2}{7}}$ in terms of x and y . [2]
 - c. Find the value of $\frac{3}{2} \log_4 16 + \log_4 \frac{1}{4}$. [4]

GE - The Geometry Curriculum (2009)

- 1 2009_06_GE_01 Triangles: Interior and Exterior Angles of
 Juliann plans on drawing $\triangle ABC$, where the measure of $\angle A$ can range from 50° to 60° and the measure of $\angle B$ can range from 90° to 100° . Given these conditions, what is the correct range of measures possible for $\angle C$?

- 1) 20° to 40°
- 2) 30° to 50°
- 3) 80° to 90°
- 4) 120° to 130°

- 2 2009_06_GE_02 Proofs: Triangle
 In the diagram of $\triangle ABC$ and $\triangle DEF$ below, $\overline{AB} \cong \overline{DE}$, $\angle A \cong \angle D$, and $\angle B \cong \angle E$.

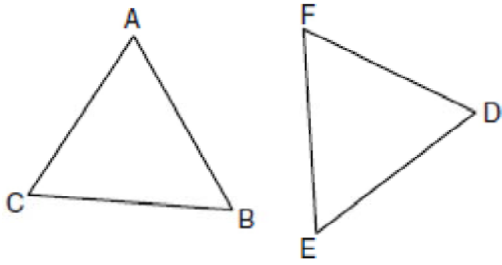

Which method can be used to prove $\triangle ABC \cong \triangle DEF$?

- 1) SSS
- 2) SAS
- 3) ASA
- 4) HL

- 3 2009_06_GE_03 Transformations: Classifications of
 In the diagram below, under which transformation will $\triangle A'B'C'$ be the image of $\triangle ABC$?

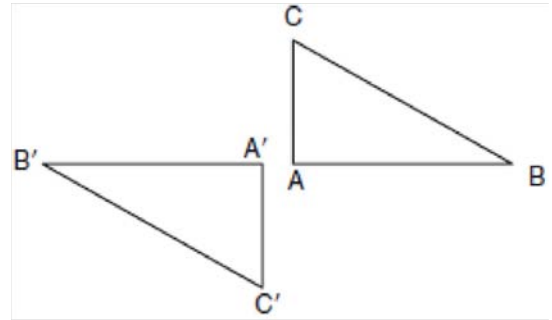

- 1) rotation
 - 2) dilation
 - 3) translation
 - 4) glide reflection
- 4 2009_06_GE_04 Solid Geometry: Pyramids and Cones
 The lateral faces of a regular pyramid are composed of
- 1) squares
 - 2) rectangles
 - 3) congruent right triangles
 - 4) congruent isosceles triangles
- 5 2009_06_GE_05 Transformations: Reflections
 Point A is located at $(4, -7)$. The point is reflected in the x -axis. Its image is located at
- 1) $(-4, 7)$
 - 2) $(-4, -7)$
 - 3) $(4, 7)$
 - 4) $(7, -4)$

6 2009_06_GE_06 Circles: Chords

In the diagram of circle O below, chords \overline{AB} and \overline{CD} are parallel, and \overline{BD} is a diameter of the circle.

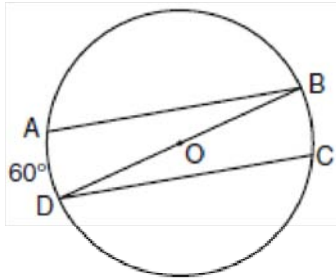

If $m\widehat{AD} = 60$, what is $m\angle CDB$?

- 1) 20
- 2) 30
- 3) 60
- 4) 120

7 2009_06_GE_07 Parallel and Perpendicular Lines

What is an equation of the line that passes through the point $(-2, 5)$ and is perpendicular to the line

whose equation is $y = \frac{1}{2}x + 5$?

- 1) $y = 2x + 1$
- 2) $y = -2x + 1$
- 3) $y = 2x + 9$
- 4) $y = -2x - 9$

8 2009_06_GE_08 Transformations: Compositions of

After a composition of transformations, the coordinates $A(4, 2)$, $B(4, 6)$, and $C(2, 6)$ become $A''(-2, -1)$, $B''(-2, -3)$, and $C''(-1, -3)$, as shown on the set of axes below.

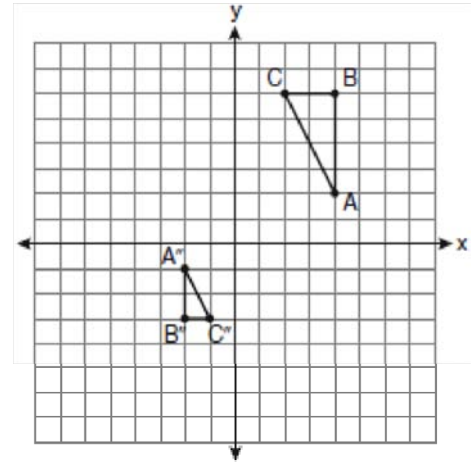

Which composition of transformations was used?

- 1) $R_{180^\circ} \circ D_2$
- 2) $R_{90^\circ} \circ D_2$
- 3) $D_{\frac{1}{2}} \circ R_{180^\circ}$
- 4) $D_{\frac{1}{2}} \circ R_{90^\circ}$

9 2009_06_GE_09 Triangles: Interior and Exterior Angles of

In an equilateral triangle, what is the difference between the sum of the exterior angles and the sum of the interior angles?

- 1) 180°
- 2) 120°
- 3) 90°
- 4) 60°

10 2009_06_GE_10 Circles: Equations of

What is an equation of a circle with its center at $(-3, 5)$ and a radius of 4?

- 1) $(x - 3)^2 + (y + 5)^2 = 16$
- 2) $(x + 3)^2 + (y - 5)^2 = 16$
- 3) $(x - 3)^2 + (y + 5)^2 = 4$
- 4) $(x + 3)^2 + (y - 5)^2 = 4$

- 11 2009_06_GE_11 Triangles: Interior and Exterior Angles of
 In $\triangle ABC$, $m\angle A = 95$, $m\angle B = 50$, and $m\angle C = 35$.
 Which expression correctly relates the lengths of
 the sides of this triangle?
 1) $AB < BC < CA$
 2) $AB < AC < BC$
 3) $AC < BC < AB$
 4) $BC < AC < AB$

- 12 2009_06_GE_12 Locus
 In a coordinate plane, how many points are both 5
 units from the origin and 2 units from the x -axis?
 1) 1
 2) 2
 3) 3
 4) 4

- 13 2009_06_GE_13 Logical Reasoning: Contrapositive
 What is the contrapositive of the statement, "If I am
 tall, then I will bump my head"?
 1) If I bump my head, then I am tall.
 2) If I do not bump my head, then I am tall.
 3) If I am tall, then I will not bump my head.
 4) If I do not bump my head, then I am not tall.

- 14 2009_06_GE_14 Means, Altitudes, Bisectors and Midsegments
 In the diagram of $\triangle ABC$ below, Jose found
 centroid P by constructing the three medians. He
 measured CF and found it to be 6 inches.

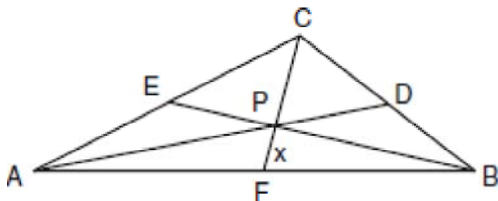

- If $PF = x$, which equation can be used to find x ?
 1) $x + x = 6$
 2) $2x + x = 6$
 3) $3x + 2x = 6$
 4) $x + \frac{2}{3}x = 6$

- 15 2009_06_GE_15 Triangles: Mean Proportionals
 In the diagram below, the length of the legs \overline{AC} and
 \overline{BC} of right triangle $\triangle ABC$ are 6 cm and 8 cm,
 respectively. Altitude \overline{CD} is drawn to the
 hypotenuse of $\triangle ABC$.

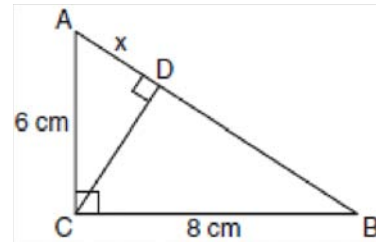

- What is the length of AD to the nearest tenth of a
 centimeter?
 1) 3.6
 2) 6.0
 3) 6.4
 4) 4.0

- 16 2009_06_GE_16 Circles: Chords, Secants and Tangents
 In the diagram below, tangent \overline{AB} and secant \overline{ACD}
 are drawn to circle O from an external point A ,
 $AB = 8$, and $AC = 4$.

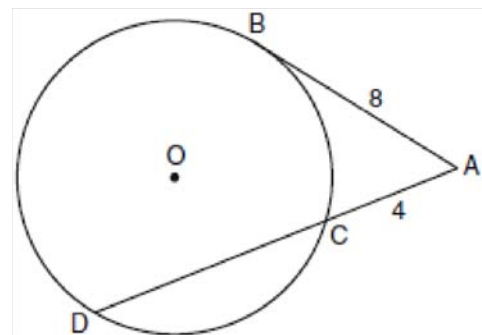

- What is the length of \overline{CD} ?
 1) 16
 2) 13
 3) 12
 4) 10

17 2009_06_GE_17 Proofs: Triangle

In the diagram of $\triangle ABC$ and $\triangle EDC$ below, \overline{AE} and \overline{BD} intersect at C , and $\angle CAB \cong \angle CED$.

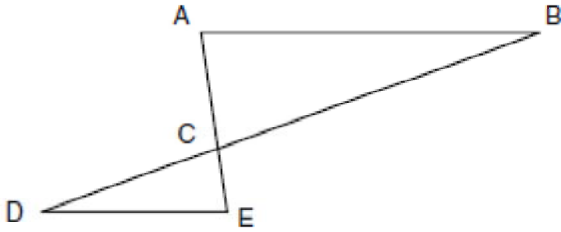

Which method can be used to show that $\triangle ABC$ must be similar to $\triangle EDC$?

- 1) SAS
- 2) AA
- 3) SSS
- 4) HL

18 2009_06_GE_18 Solid Geometry: Lines and Planes in Space
Point P is on line m . What is the total number of planes that are perpendicular to line m and pass through point P ?

- 1) 1
- 2) 2
- 3) 0
- 4) infinite

19 2009_06_GE_19 Midpoint

Square $LMNO$ is shown in the diagram below.

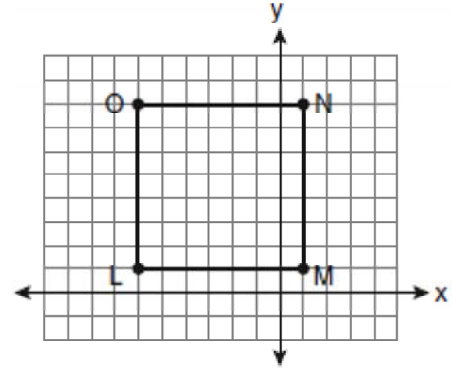

What are the coordinates of the midpoint of diagonal \overline{LN} ?

- 1) $\left(4\frac{1}{2}, -2\frac{1}{2}\right)$
- 2) $\left(-3\frac{1}{2}, 3\frac{1}{2}\right)$
- 3) $\left(-2\frac{1}{2}, 3\frac{1}{2}\right)$
- 4) $\left(-2\frac{1}{2}, 4\frac{1}{2}\right)$

- 20 2009_06_GE_20 Circles: Equations of
Which graph represents a circle with the equation $(x - 5)^2 + (y + 1)^2 = 9$?

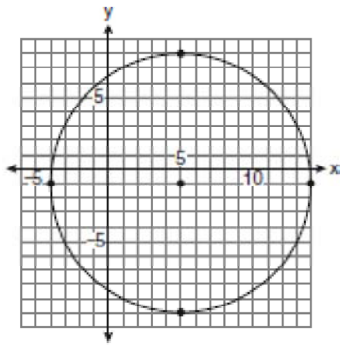
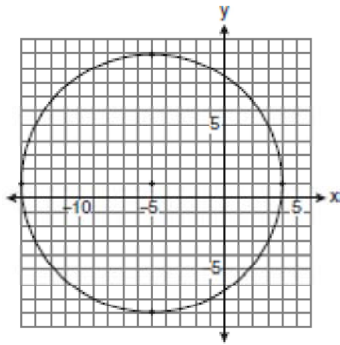
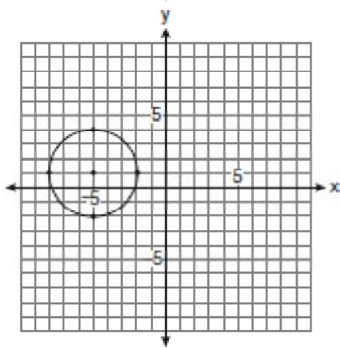
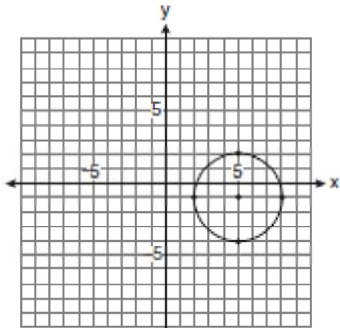

- 21 2009_06_GE_21 Solid Geometry: Pyramids and Cones
In the diagram below, a right circular cone has a diameter of 8 inches and a height of 12 inches.

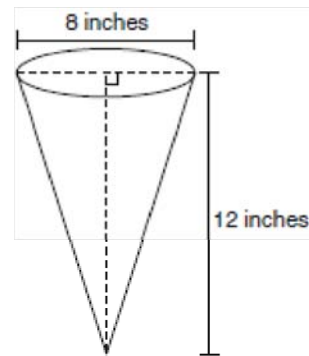

What is the volume of the cone to the *nearest cubic inch*?

- 1) 201
2) 481
3) 603
4) 804
- 22 2009_06_GE_22 Circles: Center, Radius and Circumference
A circle is represented by the equation $x^2 + (y + 3)^2 = 13$. What are the coordinates of the center of the circle and the length of the radius?

- 1) (0, 3) and 13
2) (0, 3) and $\sqrt{13}$
3) (0, -3) and 13
4) (0, -3) and $\sqrt{13}$

- 23 2009_06_GE_23 Systems: Quadratic Linear
Given the system of equations:

$$y = x^2 - 4x$$

$$x = 4$$

The number of points of intersection is

- 1) 1
2) 2
3) 3
4) 0

- 24 2009_06_GE_24 Triangle Inequalities
Side PQ of $\triangle PQR$ is extended through Q to point T . Which statement is *not* always true?
- 1) $m\angle RQT > m\angle R$
 - 2) $m\angle RQT > m\angle P$
 - 3) $m\angle RQT = m\angle P + m\angle R$
 - 4) $m\angle RQT > m\angle PQR$

- 25 2009_06_GE_25 Constructions
Which illustration shows the correct construction of an angle bisector?

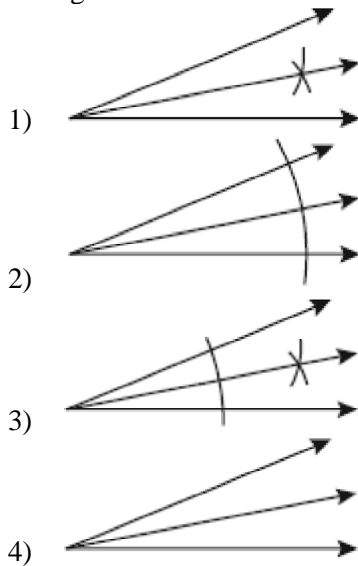

- 26 2009_06_GE_26 Parallel and Perpendicular Lines
Which equation represents a line perpendicular to the line whose equation is $2x + 3y = 12$?
- 1) $6y = -4x + 12$
 - 2) $2y = 3x + 6$
 - 3) $2y = -3x + 6$
 - 4) $3y = -2x + 12$

- 27 2009_06_GE_27 Similarity
In $\triangle ABC$, point D is on \overline{AB} , and point E is on \overline{BC} such that $DE \parallel AC$. If $DB = 2$, $DA = 7$, and $DE = 3$, what is the length of \overline{AC} ?
- 1) 8
 - 2) 9
 - 3) 10.5
 - 4) 13.5

- 28 2009_06_GE_28 Solid Geometry: Lines and Planes in Space
In three-dimensional space, two planes are parallel and a third plane intersects both of the parallel planes. The intersection of the planes is a
- 1) plane
 - 2) point
 - 3) pair of parallel lines
 - 4) pair of intersecting lines

- 29 2009_06_GE_29 Medians, Altitudes, Bisectors and Midsegments
In the diagram of $\triangle ABC$ below, $AB = 10$, $BC = 14$, and $AC = 16$. Find the perimeter of the triangle formed by connecting the midpoints of the sides of $\triangle ABC$.

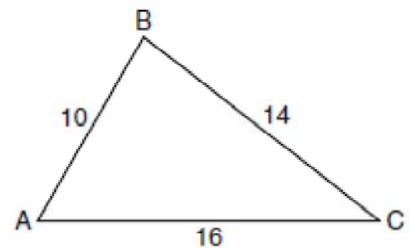

- 30 2009_06_GE_30 Constructions
Using a compass and straightedge, construct a line that passes through point P and is perpendicular to line m . [Leave all construction marks.]

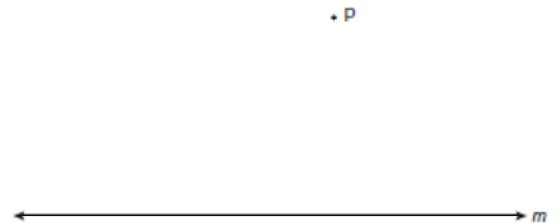

- 31 2009_06_GE_31 Parallel and Perpendicular Lines
Find an equation of the line passing through the point $(5, 4)$ and parallel to the line whose equation is $2x + y = 3$.

32 2009_06_GE_32 Locus

The length of AB is 3 inches. On the diagram below, sketch the points that are equidistant from A and B and sketch the points that are 2 inches from A . Label with an **X** all points that satisfy both conditions.



33 2009_06_GE_33 Logical Reasoning

Given: Two is an even integer or three is an even integer.

Determine the truth value of this disjunction. Justify your answer.

34 2009_06_GE_34 Similarity

In the diagram below, $\triangle ABC \sim \triangle EFG$, $m\angle C = 4x + 30$, and $m\angle G = 5x + 10$. Determine the value of x .

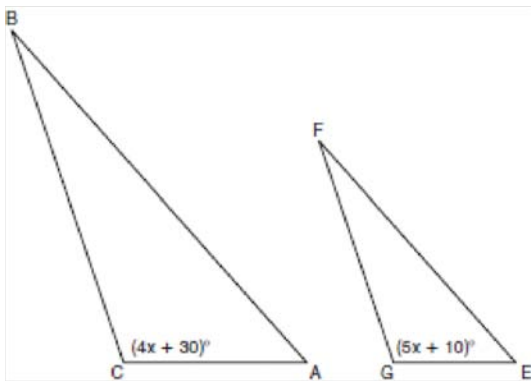

35 2009_06_GE_35 Circles: Tangents

In the diagram below, circles X and Y have two tangents drawn to them from external point T . The points of tangency are C , A , S , and E . The ratio of TA to AC is $1:3$. If $TS = 24$, find the length of SE .

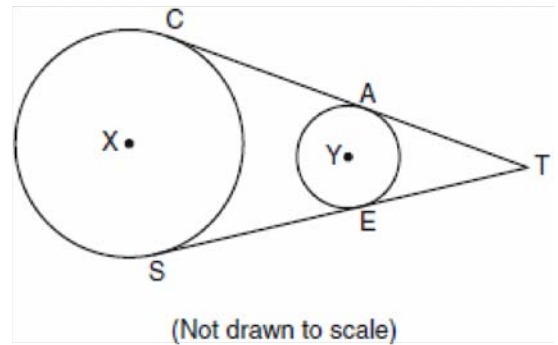

36 2009_06_GE_36 Perimeter

Triangle ABC has coordinates $A(-6, 2)$, $B(-3, 6)$, and $C(5, 0)$. Find the perimeter of the triangle. Express your answer in simplest radical form. [The use of the grid below is optional.]

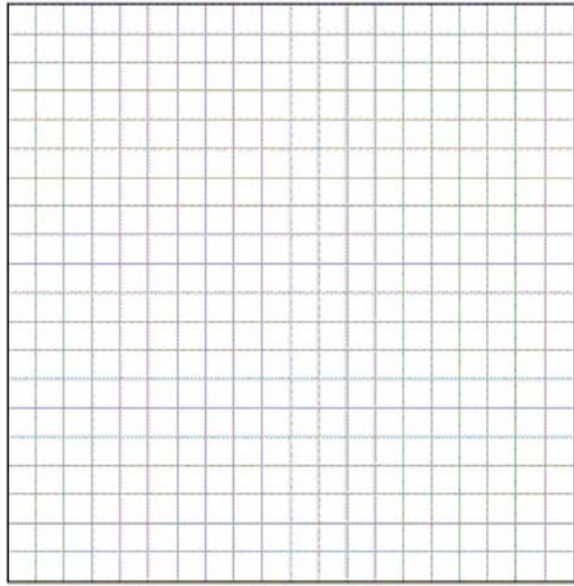

37 2009_06_GE_37 Transformations: Compositions of

The coordinates of the vertices of parallelogram $ABCD$ are $A(-2, 2)$, $B(3, 5)$, $C(4, 2)$, and $D(-1, -1)$. State the coordinates of the vertices of parallelogram $A''B''C''D''$ that result from the transformation $r_{y\text{-axis}} \circ T_{2, -3}$. [The use of the set of axes below is optional.]

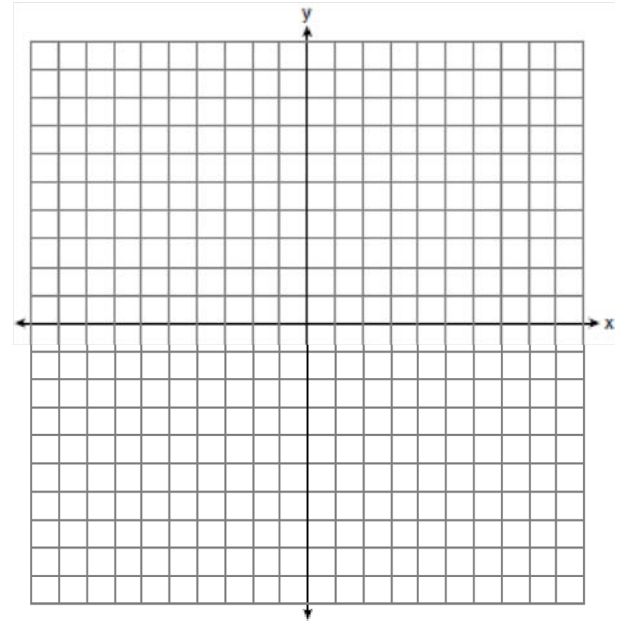

38 2009_06_GE_38 Proofs: Triangle

Given: $\triangle ABC$ and $\triangle EDC$, C is the midpoint of \overline{BD} and \overline{AE}

Prove: $\overline{AB} \parallel \overline{DE}$

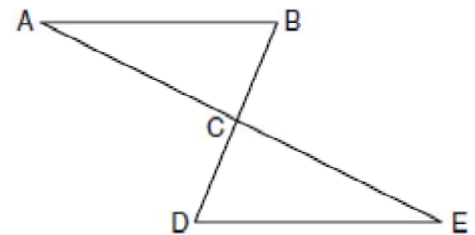

- 39 2009_08_GE_01 Parallel Lines: Angles Involving
Based on the diagram below, which statement is true?

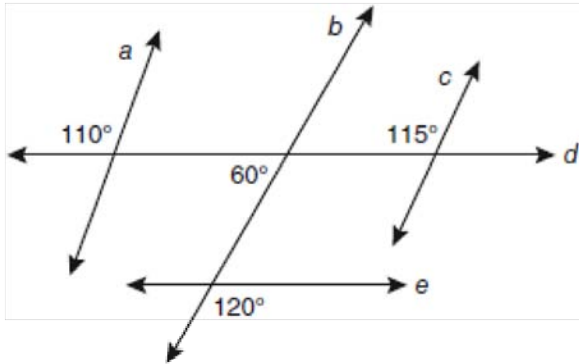

- 1) $a \parallel b$
 - 2) $a \parallel c$
 - 3) $b \parallel c$
 - 4) $d \parallel e$
- 40 2009_08_GE_02 Constructions
The diagram below shows the construction of the bisector of $\angle ABC$.

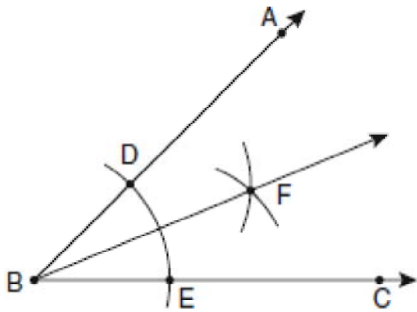

Which statement is *not* true?

- 1) $m\angle EBF = \frac{1}{2} m\angle ABC$
- 2) $m\angle DBF = \frac{1}{2} m\angle ABC$
- 3) $m\angle EBF = m\angle ABC$
- 4) $m\angle DBF = m\angle EBF$

- 41 2009_08_GE_03 Triangles: Isosceles
In the diagram of $\triangle ABC$ below, $\overline{AB} \cong \overline{AC}$. The measure of $\angle B$ is 40° .

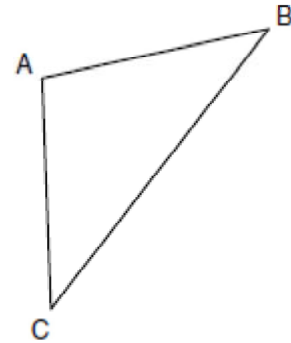

What is the measure of $\angle A$?

- 1) 40°
 - 2) 50°
 - 3) 70°
 - 4) 100°
- 42 2009_08_GE_04 Circles: Chords
In the diagram of circle O below, chord \overline{CD} is parallel to diameter \overline{AOB} and $m\widehat{AC} = 30$.

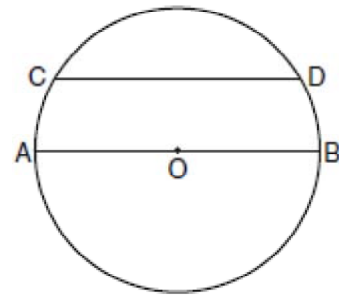

What is $m\widehat{CD}$?

- 1) 150
- 2) 120
- 3) 100
- 4) 60

- 43 2009_08_GE_05 Special Quadrilaterals: Trapezoids
 In the diagram of trapezoid $ABCD$ below, diagonals \overline{AC} and \overline{BD} intersect at E and $\triangle ABC \cong \triangle DCB$.

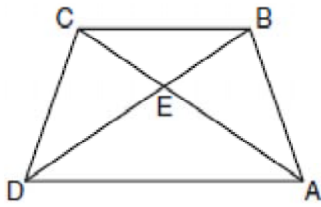

Which statement is true based on the given information?

- 1) $\overline{AC} \cong \overline{BC}$
 - 2) $\overline{CD} \cong \overline{AD}$
 - 3) $\angle CDE \cong \angle BAD$
 - 4) $\angle CDB \cong \angle BAC$
- 44 2009_08_GE_06 Transformations: Classifications of
 Which transformation produces a figure similar but not congruent to the original figure?
- 1) $T_{1,3}$
 - 2) $D \frac{1}{2}$
 - 3) R_{90°
 - 4) $r_{y=x}$
- 45 2009_08_GE_07 Special Quadrilaterals: Parallelograms
 In the diagram below of parallelogram $ABCD$ with diagonals \overline{AC} and \overline{BD} , $m\angle 1 = 45$ and $m\angle DCB = 120$.

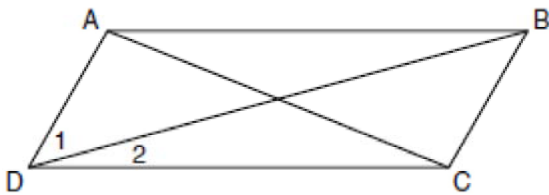

What is the measure of $\angle 2$?

- 46 2009_08_GE_08 Transformations: Compositions of
 On the set of axes below, Geoff drew rectangle $ABCD$. He will transform the rectangle by using the translation $(x, y) \rightarrow (x + 2, y + 1)$ and then will reflect the translated rectangle over the x -axis.

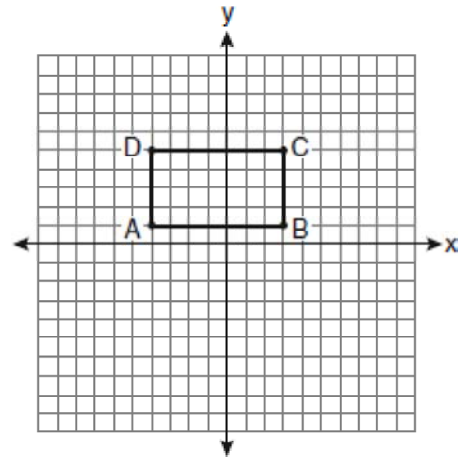

What will be the area of the rectangle after these transformations?

- 1) exactly 28 square units
 - 2) less than 28 square units
 - 3) greater than 28 square units
 - 4) It cannot be determined from the information given.
- 47 2009_08_GE_09 Parallel and Perpendicular Lines
 What is the equation of a line that is parallel to the line whose equation is $y = x + 2$?
- 1) $x + y = 5$
 - 2) $2x + y = -2$
 - 3) $y - x = -1$
 - 4) $y - 2x = 3$
- 48 2009_08_GE_10 Midpoint
 The endpoints of \overline{CD} are $C(-2, -4)$ and $D(6, 2)$.
 What are the coordinates of the midpoint of \overline{CD} ?
- 1) (2, 3)
 - 2) (2, -1)
 - 3) (4, -2)
 - 4) (4, 3)

49 2009_08_GE_11 Circles: Center, Radius and Circumference

What are the center and the radius of the circle

whose equation is $(x - 3)^2 + (y + 3)^2 = 36$

- 1) center = $(3, -3)$; radius = 6
- 2) center = $(-3, 3)$; radius = 6
- 3) center = $(3, -3)$; radius = 36
- 4) center = $(-3, 3)$; radius = 36

50 2009_08_GE_12 Systems: Quadratic Linear

Given the equations: $y = x^2 - 6x + 10$

$$y + x = 4$$

What is the solution to the given system of equations?

- 1) $(2, 3)$
- 2) $(3, 2)$
- 3) $(2, 2)$ and $(1, 3)$
- 4) $(2, 2)$ and $(3, 1)$

51 2009_08_GE_13 Proofs: Polygon

The diagonal AC is drawn in parallelogram $ABCD$.

Which method can *not* be used to prove that

$\triangle ABC \cong \triangle CDA$?

- 1) SSS
- 2) SAS
- 3) SSA
- 4) ASA

52 2009_08_GE_14 Solid Geometry: Lines and Planes in Space

In the diagram below, line k is perpendicular to plane \mathcal{P} at point T .

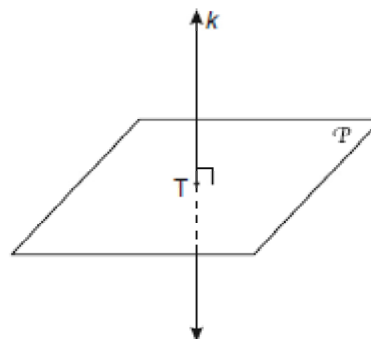

Which statement is true?

- 1) Any point in plane \mathcal{P} also will be on line k .
- 2) Only one line in plane \mathcal{P} will intersect line k .
- 3) All planes that intersect plane \mathcal{P} will pass through T .
- 4) Any plane containing line k is perpendicular to plane \mathcal{P} .

53 2009_08_GE_15 Transformations: Classifications of

In the diagram below, which transformation was used to map $\triangle ABC$ to $\triangle A'B'C'$?

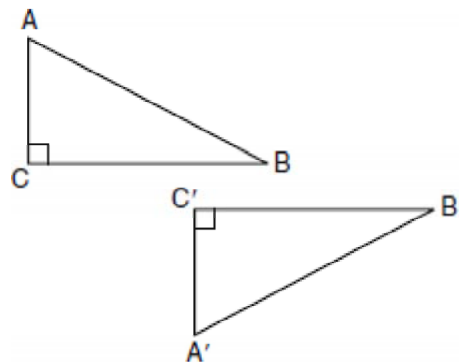

- 1) dilation
- 2) rotation
- 3) reflection
- 4) glide reflection

- 54 2009_08_GE_16 Triangle Inequalities
Which set of numbers represents the lengths of the sides of a triangle?
- 1) {5, 18, 13}
 - 2) {6, 17, 22}
 - 3) {16, 24, 7}
 - 4) {26, 8, 15}

- 55 2009_08_GE_17 Parallel and Perpendicular Lines
What is the slope of a line perpendicular to the line whose equation is $y = -\frac{2}{3}x - 5$?
- 1) $-\frac{3}{2}$
 - 2) $-\frac{2}{3}$
 - 3) $\frac{2}{3}$
 - 4) $\frac{3}{2}$

- 56 2009_08_GE_18 Special Quadrilaterals: Rhombuses
A quadrilateral whose diagonals bisect each other and are perpendicular is a
- 1) rhombus
 - 2) rectangle
 - 3) trapezoid
 - 4) parallelogram

- 57 2009_08_GE_19 Distance
If the endpoints of \overline{AB} are $A(-4, 5)$ and $B(2, -5)$, what is the length of \overline{AB} ?
- 1) $2\sqrt{34}$
 - 2) 2
 - 3) $\sqrt{61}$
 - 4) 8

- 58 2009_08_GE_20 Medians, Altitudes, Bisectors and Midsegments
In the diagram below of $\triangle ACT$, D is the midpoint of \overline{AC} , O is the midpoint of \overline{AT} , and G is the midpoint of \overline{CT} .

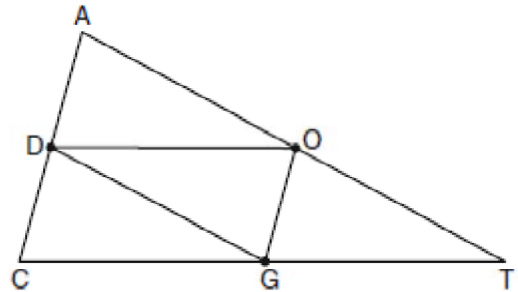

- If $AC = 10$, $AT = 18$, and $CT = 22$, what is the perimeter of parallelogram $CDOG$?
- 1) 21
 - 2) 25
 - 3) 32
 - 4) 40

- 59 2009_08_GE_21 Circles: Equations of
Which equation represents circle K shown in the graph below?

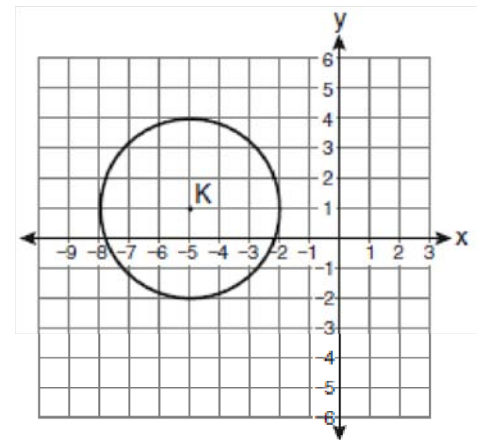

- 1) $(x + 5)^2 + (y - 1)^2 = 3$
- 2) $(x + 5)^2 + (y - 1)^2 = 9$
- 3) $(x - 5)^2 + (y + 1)^2 = 3$
- 4) $(x - 5)^2 + (y + 1)^2 = 9$

- 60 2009_08_GE_22 Triangles: Mean Proportionals
 In the diagram below of right triangle ACB , altitude CD is drawn to hypotenuse AB .

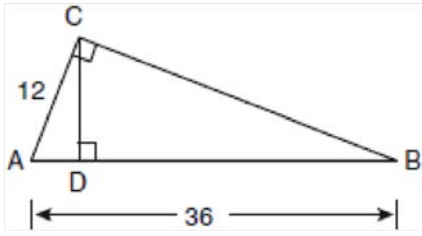

If $AB = 36$ and $AC = 12$, what is the length of AD ?

- 1) 32
 - 2) 6
 - 3) 3
 - 4) 4
- 61 2009_08_GE_23 Circles: Chords
 In the diagram of circle O below, chord AB intersects chord CD at E , $DE = 2x + 8$, $EC = 3$, $AE = 4x - 3$, and $EB = 4$.

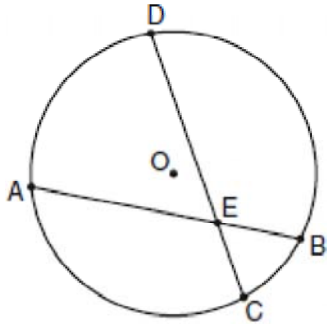

What is the value of x ?

- 1) 1
 - 2) 3.6
 - 3) 5
 - 4) 10.25
- 62 2009_08_GE_24 Logical Reasoning
 What is the negation of the statement "Squares are parallelograms"?
- 1) Parallelograms are squares.
 - 2) Parallelograms are not squares.
 - 3) It is not the case that squares are parallelograms.
 - 4) It is not the case that parallelograms are squares.

- 63 2009_08_GE_25 Medians, Altitudes, Bisectors and Midsegments
 The diagram below shows the construction of the center of the circle circumscribed about $\triangle ABC$.

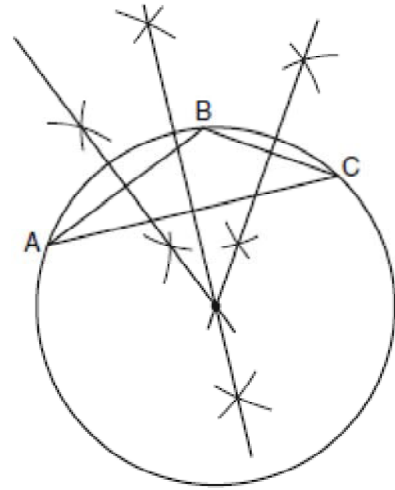

This construction represents how to find the intersection of

- 1) the angle bisectors of $\triangle ABC$
 - 2) the medians to the sides of $\triangle ABC$
 - 3) the altitudes to the sides of $\triangle ABC$
 - 4) the perpendicular bisectors of the sides of $\triangle ABC$
- 64 2009_08_GE_26 Solid Geometry: Prisms and Cylinders
 A right circular cylinder has a volume of 1,000 cubic inches and a height of 8 inches. What is the radius of the cylinder to the nearest tenth of an inch?
- 1) 6.3
 - 2) 11.2
 - 3) 19.8
 - 4) 39.8
- 65 2009_08_GE_27 Solid Geometry: Lines and Planes in Space
 If two different lines are perpendicular to the same plane, they are
- 1) collinear
 - 2) coplanar
 - 3) congruent
 - 4) consecutive

- 66 2009_08_GE_28 Circles: Tangents
How many common tangent lines can be drawn to the two externally tangent circles shown below?

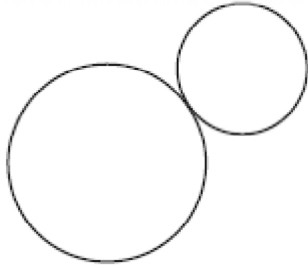

- 1) 1
2) 2
3) 3
4) 4
- 67 2009_08_GE_29 Special Quadrilaterals: Trapezoids
In the diagram below of isosceles trapezoid $DEFG$, $\overline{DE} \parallel \overline{GF}$, $DE = 4x - 2$, $EF = 3x + 2$, $FG = 5x - 3$, and $GD = 2x + 5$. Find the value of x .

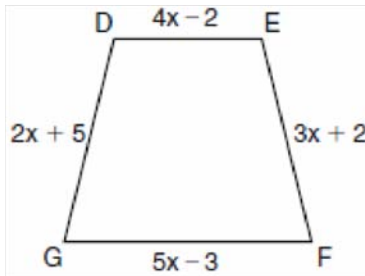

- 68 2009_08_GE_30 Solid Geometry: Pyramids and Cones
A regular pyramid with a square base is shown in the diagram below.

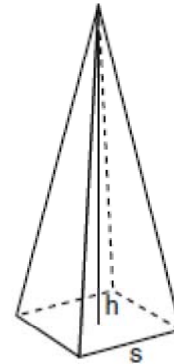

- A side, s , of the base of the pyramid is 12 meters, and the height, h , is 42 meters. What is the volume of the pyramid in cubic meters?
- 69 2009_08_GE_31 Parallel and Perpendicular Lines
Write an equation of the line that passes through the point $(6, -5)$ and is parallel to the line whose equation is $2x - 3y = 11$.
- 70 2009_08_GE_32 Constructions
Using a compass and straightedge, construct the angle bisector of $\angle ABC$ shown below. [Leave all construction marks.]

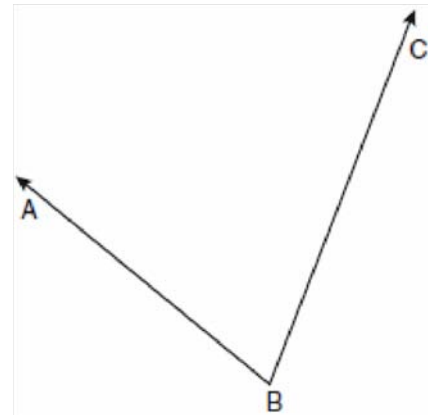

- 71 2009_08_GE_33 Triangles: Interior and Exterior Angles of
The degree measures of the angles of $\triangle ABC$ are represented by x , $3x$, and $5x - 54$. Find the value of x .

72 2009_08_GE_34 Triangles: Interior and Exterior Angles of

In the diagram below of $\triangle ABC$ with side AC extended through D , $m\angle A = 37$ and $m\angle BCD = 117$. Which side of $\triangle ABC$ is the longest side? Justify your answer.

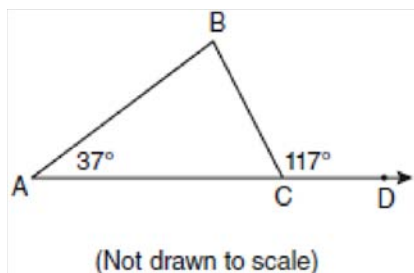

73 2009_08_GE_35 Parallel and Perpendicular Lines

Write an equation of the perpendicular bisector of the line segment whose endpoints are $(-1, 1)$ and $(7, -5)$. [The use of the grid below is optional]

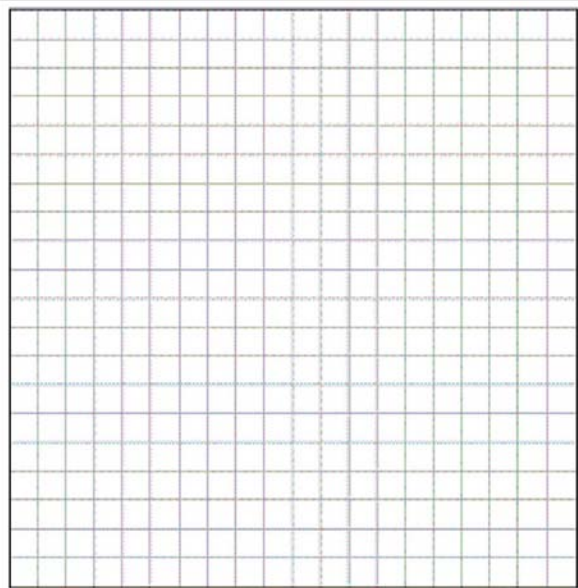

74 2009_08_GE_36 Locus

On the set of axes below, sketch the points that are 5 units from the origin and sketch the points that are 2 units from the line $y = 3$. Label with an **X** all points that satisfy both conditions.

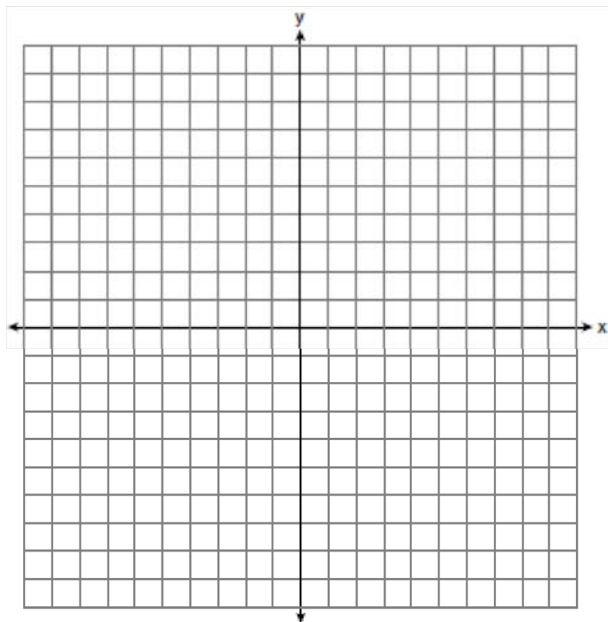

75 2009_08_GE_37 Transformations: Rotations

Triangle DEG has the coordinates $D(1, 1)$, $E(5, 1)$, and $G(5, 4)$. Triangle DEG is rotated 90° about the origin to form $\triangle D'E'G'$. On the grid below, graph and label $\triangle DEG$ and $\triangle D'E'G'$. State the coordinates of the vertices D' , E' , and G' . Justify that this transformation preserves distance.

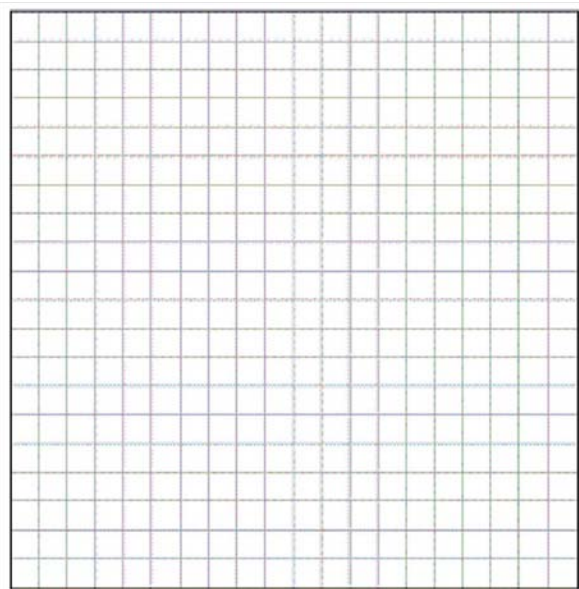

76 2009_08_GE_38 Proofs: Polygon

Given: Quadrilateral $ABCD$, diagonal $AFEC$,
 $\overline{AE} \cong \overline{FC}$, $\overline{BF} \perp \overline{AC}$, $\overline{DE} \perp \overline{AC}$, $\angle 1 \cong \angle 2$
Prove: $ABCD$ is a parallelogram.

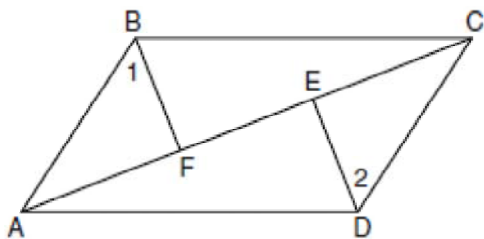

HA - The Higher Algebra Curriculum (1890)

- 1 1890_01_HA_01 Radicals: Square Roots
Find the square root of $28 + 10\sqrt{3}$.
- 2 1890_01_HA_02 Exponents: Operations with
Multiply $a^{\frac{4}{3}} - 2 + a^{-\frac{4}{3}}$ by $a^{\frac{2}{3}} - a^{-\frac{2}{3}}$
- 3 1890_01_HA_03 Quadratics: Completing the Square
Find the quadratic equation whose roots are 7 and -6. And use this equation to illustrate two methods of completing the square.
- 4 1890_01_HA_04 Radicals: Operations with
Solve $\frac{\sqrt{a^2 + x^2} - a}{\sqrt{a^2 + x^2} + a} = b$
- 5 1890_01_HA_05 Systems: Other Nonlinear
Solve $x^2 + xy = 56$
 $xy + 2y = 60$
- 6 1890_01_HA_06 Systems: Other Nonlinear
The sum of the cubes of two numbers is to the difference of their cubes as 559 to 127, and the squares of the first multiplied by the second is equal to 294. Find the numbers.
- 7 1890_01_HA_07 Progressions: Arithmetic
The first term of an arithmetical progression is $n^2 - n + 1$ and the common difference is 2. Find the sum of n terms.
- 8 1890_01_HA_08 Progressions: Geometric
The product of three numbers in geometrical progression is 64, and the sum of their cubes is 584. Find the numbers.
- 9 1890_01_HA_09 Logarithms
What is meant by the base of a system of logarithms; the modulus; the mantissa?
- 10 1890_01_HA_10 Binomial Expansions
Expand by the binomial theorem $\left(a^4 + b^{\frac{1}{2}}\right)^{-\frac{7}{2}}$ giving the first six terms.
- 11 1890_01_HA_11 Combinatorics: Combinations
How many different combinations may be formed from the letters in the name New York, taking three at a time?
- 12 1890_01_HA_12 Fractions: Partial
Separate $\frac{x^2}{(x^2 - 1)(x - 2)}$ into its partial fractions
- 13 1890_01_HA_13 Series: Infinite
Develop $\frac{1 + x}{x - 2x^2 + 6x^3}$ into an infinite series.
- 14 1890_01_HA_14 Equations: Higher Order
Solve $x^4 - 6x^3 + 3x^2 + 26x - 24 = 0$.
- 15 1890_03_HA_01 Radicals: Rationalizing Denominators
Rationalize the denominator of the following fraction: $\frac{\sqrt{x} - 4\sqrt{x-2}}{2\sqrt{x} + 3\sqrt{x-2}}$
- 16 1890_03_HA_02 Exponents: Operations with
Divide $6a^{-1}b^{\frac{2}{3}}$ by $-3ab^{-\frac{1}{5}}$.
- 17 1890_03_HA_03 Equations: Forming Higher Order from Roots
Form the equation whose roots are $\pm 3, \pm \sqrt{-13}$, and solve the equation.

- 18 1890_03_HA_04 Radicals: Operations with
Solve $\sqrt{x^2 - 3x + 5} - \sqrt{x^2 - 5x - 2} = 1$.
- 19 1890_03_HA_05 Systems: Other Nonlinear
Solve $x^2 + y = 5(x - y)$
 $x + y^2 = 2(x - y)$
- 20 1890_03_HA_06 Systems: Other Nonlinear
Find two numbers such that their difference added to the difference of their squares shall make 150 and their sum added to the sum of their squares shall make 330.
- 21 1890_03_HA_07 Progressions: Arithmetic
A traveler has a journey of 132 miles to perform. He goes 27 miles the first day, 24 the second, and so on, traveling 3 miles less each day than the day before. In how many days will he complete the journey?
- 22 1890_03_HA_08 Progressions: Arithmetic and Geometric
Show that if, in a geometrical progression, each term be added to or subtracted from that next following, the sums or the remainders will form a geometrical progression.
- 23 1890_03_HA_09 Logarithms
Show that $\log_b b$ to the base a multiplied by $\log_a a$ to the base $b = 1$ for any values of a and b .
- 24 1890_03_HA_10 Binomial Expansions
Find the 5th term of $(1 - a^2)^{12}$.
- 25 1890_03_HA_11 Combinatorics: Multiplication Counting Principle
If there are three routes between each successive two of the five cities, Boston, New York, Philadelphia, Baltimore, Washington, by how many routes could we travel from Boston to Washington?
- 26 1890_03_HA_12 Fractions: Partial
Resolve the fraction $\frac{5x - 12}{x^2 - 5x + 6}$ into partial fractions.
- 27 1890_03_HA_13 Series: Infinite
Expand $\frac{1 - x}{1 - 2x - 3x^2}$ into an infinite series.
- 28 1890_03_HA_14 Equations: Logarithmic
Find the value of x in $2^x = 16$ when $\log 2 = .30103$.
- 29 1890_03_HA_15 Equations: Roots of Higher Order
Required the three roots of the equations $x^3 = a^3$, or $x^3 - a^3 = 0$.

IA - The Integrated Algebra Curriculum (2009)

1 2009_01_IA_01 Conversions

On a certain day in Toronto, Canada, the temperature was 15° Celsius (C). Using the formula $F = \frac{9}{5}C + 32$, Peter converts this temperature to degrees Fahrenheit (F). Which temperature represents 15°C in degrees Fahrenheit?

- 1) -9
- 2) 35
- 3) 59
- 4) 85

2 2009_01_IA_02 Rate, Time and Distance

What is the speed, in meters per second, of a paper airplane that flies 24 meters in 6 seconds?

- 1) 144
- 2) 30
- 3) 18
- 4) 4

3 2009_01_IA_03 Probability: Theoretical

The faces of a cube are numbered from 1 to 6. If the cube is rolled once, which outcome is *least* likely to occur?

- 1) rolling an odd number
- 2) rolling an even number
- 3) rolling a number less than 6
- 4) rolling a number greater than 4

4 2009_01_IA_04 Inequalities: Writing Systems of

Tamara has a cell phone plan that charges \$0.07 per minute plus a monthly fee of \$19.00. She budgets \$29.50 per month for total cell phone expenses without taxes. What is the maximum number of minutes Tamara could use her phone each month in order to stay within her budget?

- 1) 150
- 2) 271
- 3) 421
- 4) 692

5 2009_01_IA_05 Graphic Representation of Data

Antwaan leaves a cup of hot chocolate on the counter in his kitchen. Which graph is the best representation of the change in temperature of his hot chocolate over time?

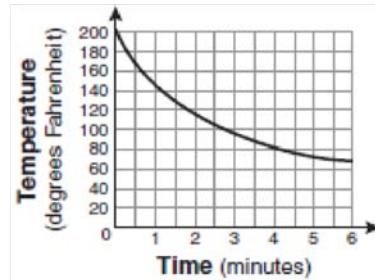

1)

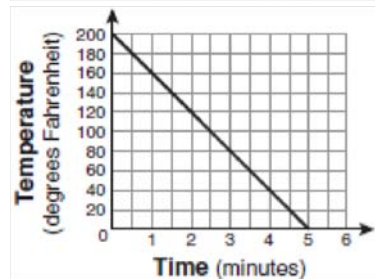

2)

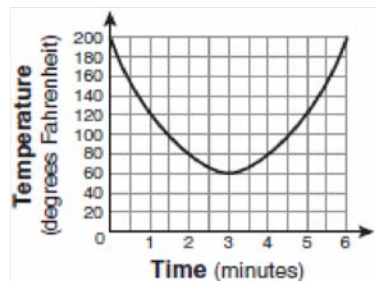

3)

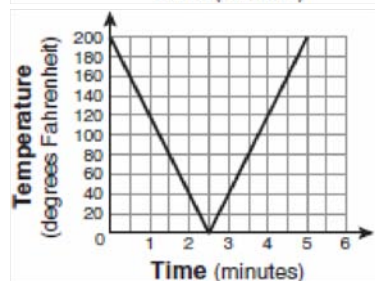

4)

6 2009_01_IA_06 Equations: Simple with Fractional Expressions

What is the solution of $\frac{k+4}{2} = \frac{k+9}{3}$?

- 1) 1
- 2) 5
- 3) 6
- 4) 14

7 2009_01_IA_07 Central Tendency
 Alex earned scores of 60, 74, 82, 87, 87, and 94 on his first six algebra tests. What is the relationship between the measures of central tendency of these scores?

- 1) median < mode < mean
- 2) mean < mode < median
- 3) mode < median < mean
- 4) mean < median < mode

8 2009_01_IA_08 Exponential Functions and Equations
 The New York Volleyball Association invited 64 teams to compete in a tournament. After each round, half of the teams were eliminated. Which equation represents the number of teams, t , that remained in the tournament after r rounds?

- 1) $t = 64(r)^{0.5}$
- 2) $t = 64(-0.5)^r$
- 3) $t = 64(1.5)^r$
- 4) $t = 64(0.5)^r$

9 2009_01_IA_09 Quadratics: Difference of Perfect Squares
 The expression $9x^2 - 100$ is equivalent to

- 1) $(9x - 10)(x + 10)$
- 2) $(3x - 10)(3x + 10)$
- 3) $(3x - 100)(3x - 1)$
- 4) $(9x - 100)(x + 1)$

10 2009_01_IA_10 Equations: Writing Linear
 What is an equation of the line that passes through the points $(3, -3)$ and $(-3, -3)$?

- 1) $y = 3$
- 2) $x = -3$
- 3) $y = -3$
- 4) $x = y$

11 2009_01_IA_11 Equations: Literal
 If the formula for the perimeter of a rectangle is $P = 2l + 2w$, then w can be expressed as

- 1) $w = \frac{2l - P}{2}$
- 2) $w = \frac{P - 2l}{2}$
- 3) $w = \frac{P - l}{2}$
- 4) $w = \frac{P - 2w}{2l}$

12 2009_01_IA_12 Trigonometry: Finding Sides
 In the right triangle shown in the diagram below, what is the value of x to the nearest whole number?

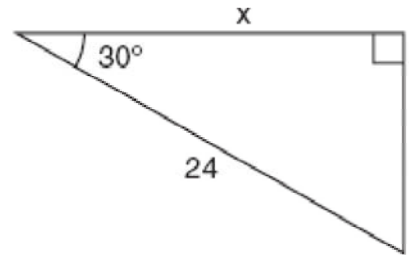

- 1) 12
- 2) 14
- 3) 21
- 4) 28

13 2009_01_IA_13 Slope
 What is the slope of the line that passes through the points $(2, 5)$ and $(7, 3)$?

- 1) $-\frac{5}{2}$
- 2) $-\frac{2}{5}$
- 3) $\frac{8}{9}$
- 4) $\frac{9}{8}$

14 2009_01_IA_14 Quadratics: Solving by Factoring
 What are the roots of the equation

$$x^2 - 10x + 21 = 0?$$

- 1) 1 and 21
- 2) -5 and -5
- 3) 3 and 7
- 4) -3 and -7

15 2009_01_IA_15 Equations and Expressions: Modeling
 Rhonda has \$1.35 in nickels and dimes in her pocket. If she has six more dimes than nickels, which equation can be used to determine x , the number of nickels she has?

- 1) $0.05(x + 6) + 0.10x = 1.35$
- 2) $0.05x + 0.10(x + 6) = 1.35$
- 3) $0.05 + 0.10(6x) = 1.35$
- 4) $0.15(x + 6) = 1.35$

- 16 2009_01_IA_16 Quadratics: Axis of Symmetry
Which equation represents the axis of symmetry of the graph of the parabola below?

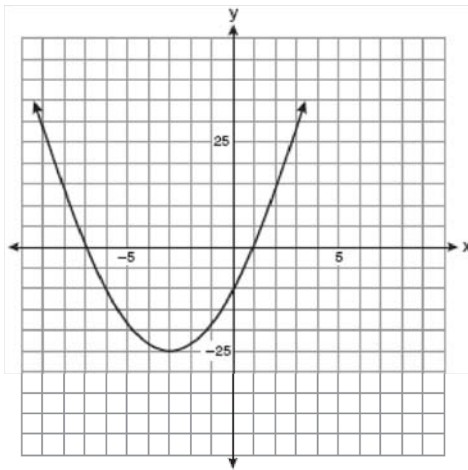

- 1) $y = -3$
 - 2) $x = -3$
 - 3) $y = -25$
 - 4) $x = -25$
- 17 2009_01_IA_17 Set Theory
The set $\{1, 2, 3, 4\}$ is equivalent to
- 1) $\{x | 1 < x < 4, \text{ where } x \text{ is a whole number}\}$
 - 2) $\{x | 0 < x < 4, \text{ where } x \text{ is a whole number}\}$
 - 3) $\{x | 0 < x \leq 4, \text{ where } x \text{ is a whole number}\}$
 - 4) $\{x | 1 < x \leq 4, \text{ where } x \text{ is a whole number}\}$

- 18 2009_01_IA_18 Rationals: Solving
What is the value of x in the equation $\frac{2}{x} - 3 = \frac{26}{x}$?

- 1) -8
- 2) $-\frac{1}{8}$
- 3) $\frac{1}{8}$
- 4) 8

- 19 2009_01_IA_19 Trigonometric Ratios: Basic
The diagram below shows right triangle UPC .

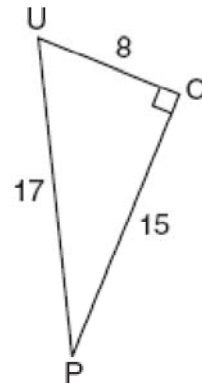

- Which ratio represents the sine of $\angle U$?
- 1) $\frac{15}{8}$
 - 2) $\frac{15}{17}$
 - 3) $\frac{8}{15}$
 - 4) $\frac{8}{17}$
- 20 2009_01_IA_20 Radicals: Simplifying
What is $\sqrt{72}$ expressed in simplest radical form?
- 1) $2\sqrt{18}$
 - 2) $3\sqrt{8}$
 - 3) $6\sqrt{2}$
 - 4) $8\sqrt{3}$
- 21 2009_01_IA_21 Rationals: Addition and Subtraction of
What is $\frac{6}{5x} - \frac{2}{3x}$ in simplest form?
- 1) $\frac{8}{15x^2}$
 - 2) $\frac{8}{15x}$
 - 3) $\frac{4}{15x}$
 - 4) $\frac{4}{2x}$

- 22 2009_01_IA_22 Systems: Quadratic Linear
Which ordered pair is a solution of the system of equations $y = x^2 - x - 20$ and $y = 3x - 15$?

- 1) $(-5, -30)$
- 2) $(-1, -18)$
- 3) $(0, 5)$
- 4) $(5, -1)$

- 23 2009_01_IA_23 Analysis of Data
A survey is being conducted to determine which types of television programs people watch. Which survey and location combination would likely contain the most bias?

- 1) surveying 10 people who work in a sporting goods store
- 2) surveying the first 25 people who enter a grocery store
- 3) randomly surveying 50 people during the day in a mall
- 4) randomly surveying 75 people during the day in a clothing store

- 24 2009_01_IA_24 Quadratics: Solving
The length of a rectangular room is 7 less than three times the width, w , of the room. Which expression represents the area of the room?

- 1) $3w - 4$
- 2) $3w - 7$
- 3) $3w^2 - 4w$
- 4) $3w^2 - 7w$

- 25 2009_01_IA_25 Rationals: Undefined
The function $y = \frac{x}{x^2 - 9}$ is undefined when the

- value of x is
- 1) 0 or 3
 - 2) 3 or -3
 - 3) 3, only
 - 4) -3 , only

- 26 2009_01_IA_26 Parallel and Perpendicular Lines
Which equation represents a line that is parallel to the line $y = 3 - 2x$?

- 1) $4x + 2y = 5$
- 2) $2x + 4y = 1$
- 3) $y = 3 - 4x$
- 4) $y = 4x - 2$

- 27 2009_01_IA_27 Scientific Notation
What is the product of 8.4×10^8 and 4.2×10^3 written in scientific notation?

- 1) 2.0×10^5
- 2) 12.6×10^{11}
- 3) 35.28×10^{11}
- 4) 3.528×10^{12}

- 28 2009_01_IA_28 Probability: Independent Events
Keisha is playing a game using a wheel divided into eight equal sectors, as shown in the diagram below. Each time the spinner lands on orange, she will win a prize.

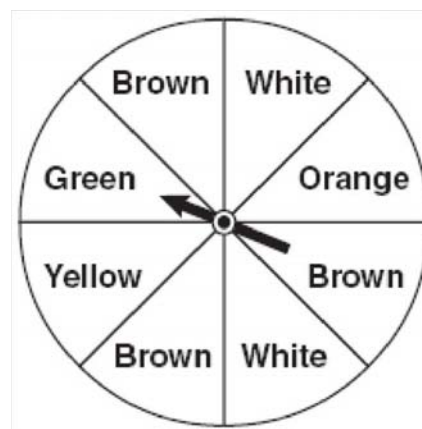

If Keisha spins this wheel twice, what is the probability she will win a prize on *both* spins?

- 1) $\frac{1}{64}$
- 2) $\frac{1}{56}$
- 3) $\frac{1}{16}$
- 4) $\frac{1}{4}$

29 2009_01_IA_29 Graphic Representation of Data

A movie theater recorded the number of tickets sold daily for a popular movie during the month of June. The box-and-whisker plot shown below represents the data for the number of tickets sold, in hundreds.

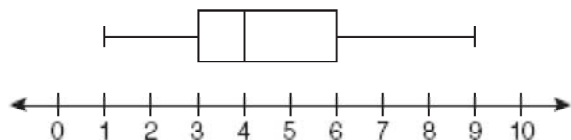

Which conclusion can be made using this plot?

- 1) The second quartile is 600.
- 2) The mean of the attendance is 400.
- 3) The range of the attendance is 300 to 600.
- 4) Twenty-five percent of the attendance is between 300 and 400.

30 2009_01_IA_30 Functions: Defining

Which graph represents a function?

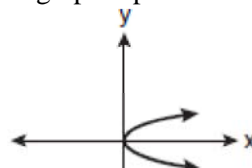

1)

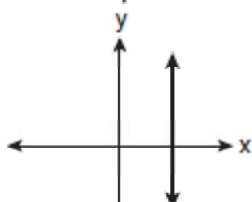

2)

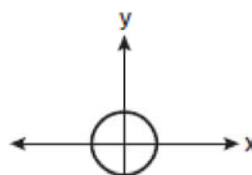

3)

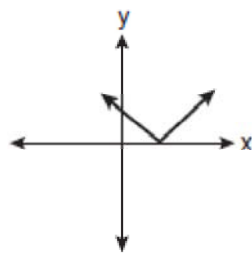

4)

- 31 2009_01_IA_31 Polygons and Circles: Compositions of
A window is made up of a single piece of glass in the shape of a semicircle and a rectangle, as shown in the diagram below. Tess is decorating for a party and wants to put a string of lights all the way around the outside edge of the window.

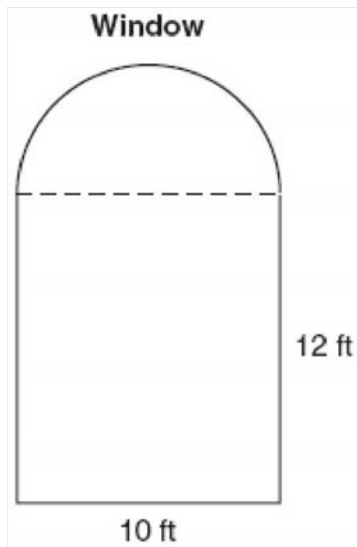

To the *nearest foot*, what is the length of the string of lights that Tess will need to decorate the window?

- 32 2009_01_IA_32 Exponents

Simplify: $\frac{27k^5m^8}{(4k^3)(9m^2)}$

- 33 2009_01_IA_33 Equations: Modeling from a Table
The table below represents the number of hours a student worked and the amount of money the student earned.

Number of Hours (h)	Dollars Earned (d)
8	\$50.00
15	\$93.75
19	\$118.75
30	\$187.50

Write an equation that represents the number of dollars, d , earned in terms of the number of hours, h , worked. Using this equation, determine the number of dollars the student would earn for working 40 hours.

- 34 2009_01_IA_34 Error

Sarah measures her rectangular bedroom window for a new shade. Her measurements are 36 inches by 42 inches. The actual measurements of the window are 36.5 inches and 42.5 inches. Using the measurements that Sarah took, determine the number of square inches in the area of the window. Determine the number of square inches in the actual area of the window. Determine the relative error in calculating the area. Express your answer as a decimal to the *nearest thousandth*.

- 35 2009_01_IA_35 Fractions: Complex

Perform the indicated operation and simplify:

$$\frac{3x+6}{4x+12} \div \frac{x^2-4}{x+3}$$

- 36 2009_01_IA_36 Solid Geometry: Prisms and Cylinders

A soup can is in the shape of a cylinder. The can has a volume of 342 cm^3 and a diameter of 6 cm. Express the height of the can in terms of π . Determine the maximum number of soup cans that can be stacked on their base between two shelves if the distance between the shelves is exactly 36 cm. Explain your answer.

37 2009_01_IA_37 Systems: Linear

Solve the following system of equations algebraically:

$$3x + 2y = 4$$

$$4x + 3y = 7$$

[Only an algebraic solution can receive full credit.]

38 2009_01_IA_38 Inequalities: Graphing Systems of

On the set of axes below, graph the following system of inequalities and state the coordinates of a point in the solution set.

$$2x - y \geq 6$$

$$x > 2$$

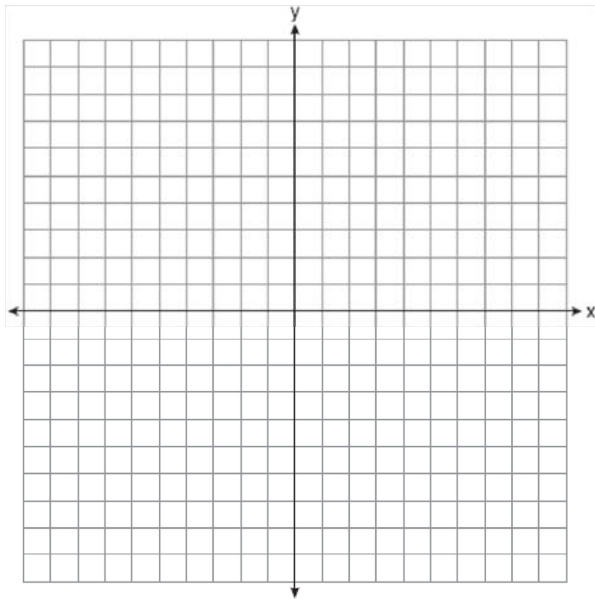

39 2009_01_IA_39 Probability: Sample Space

A restaurant sells kids' meals consisting of one main course, one side dish, and one drink, as shown in the table below.

Kids' Meal Choices

Main Course	Side Dish	Drink
hamburger	French fries	milk
chicken nuggets	applesauce	juice
turkey sandwich		soda

Draw a tree diagram or list the sample space showing all possible kids' meals. How many different kids' meals can a person order? Jose does not drink juice. Determine the number of different kids' meals that do *not* include juice. Jose's sister will eat *only* chicken nuggets for her main course. Determine the number of different kids' meals that include chicken nuggets.

40 2009_06_IA_01 Rate, Time and Distance

It takes Tammy 45 minutes to ride her bike 5 miles. At this rate, how long will it take her to ride 8 miles?

- 1) 0.89 hour
- 2) 1.125 hours
- 3) 48 minutes
- 4) 72 minutes

41 2009_06_IA_02 Quadratics: Solving

What are the roots of the equation $x^2 - 7x + 6 = 0$?

- 1) 1 and 7
- 2) -1 and 7
- 3) -1 and -6
- 4) 1 and 6

42 2009_06_IA_03 Exponents

Which expression represents $\frac{27x^{18}y^5}{9x^6y}$ in simplest

form?

- 1) $3x^{12}y^4$
- 2) $3x^3y^5$
- 3) $18x^{12}y^4$
- 4) $18x^3y^5$

- 43 2009_06_IA_04 Equations and Expressions: Modeling
 Marie currently has a collection of 58 stamps. If she buys s stamps each week for w weeks, which expression represents the total number of stamps she will have?
- 1) $58sw$
 - 2) $58 + sw$
 - 3) $58s + w$
 - 4) $58 + s + w$

- 44 2009_06_IA_05 Analysis of Data
 Which data set describes a situation that could be classified as qualitative?
- 1) the ages of the students in Ms. Marshall's Spanish class
 - 2) the test scores of the students in Ms. Fitzgerald's class
 - 3) the favorite ice cream flavor of each of Mr. Hayden's students
 - 4) the heights of the players on the East High School basketball team

- 45 2009_06_IA_06 Inequalities: Linear
 The sign shown below is posted in front of a roller coaster ride at the Wadsworth County Fairgrounds.

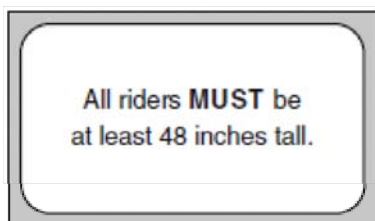

If h represents the height of a rider in inches, what is a correct translation of the statement on this sign?

- 1) $h < 48$
- 2) $h > 48$
- 3) $h \leq 48$
- 4) $h \geq 48$

- 46 2009_06_IA_07 Equations: Simple with Fractional Expressions
 Which value of x is the solution of the equation $\frac{2x}{3} + \frac{x}{6} = 5$?
- 1) 6
 - 2) 10
 - 3) 15
 - 4) 30

- 47 2009_06_IA_08 Probability: Experimental
 Students in Ms. Nazzeer's mathematics class tossed a six-sided number cube whose faces are numbered 1 to 6. The results are recorded in the table below.

Result	Frequency
1	3
2	6
3	4
4	6
5	4
6	7

Based on these data, what is the empirical probability of tossing a 4?

- 1) $\frac{8}{30}$
- 2) $\frac{6}{30}$
- 3) $\frac{5}{30}$
- 4) $\frac{1}{30}$

48 2009_06_IA_09 Triangles: Pythagoras

What is the value of x , in inches, in the right triangle below?

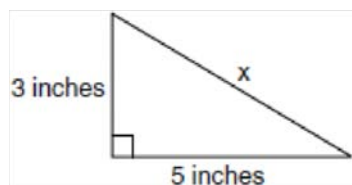

- 1) $\sqrt{15}$
- 2) 8
- 3) $\sqrt{34}$
- 4) 4

49 2009_06_IA_10 Radicals: Simplifying

What is $\sqrt{32}$ expressed in simplest radical form?

- 1) $16\sqrt{2}$
- 2) $4\sqrt{2}$
- 3) $4\sqrt{8}$
- 4) $2\sqrt{8}$

50 2009_06_IA_11 Conversions

If the speed of sound is 344 meters per second, what is the approximate speed of sound, in meters per hour?

60 seconds = 1 minute
60 minutes = 1 hour

- 1) 20,640
- 2) 41,280
- 3) 123,840
- 4) 1,238,400

51 2009_06_IA_12 Systems: Writing

The sum of two numbers is 47, and their difference is 15. What is the larger number?

- 1) 16
- 2) 31
- 3) 32
- 4) 36

52 2009_06_IA_13 Equations: Literal

If $a + ar = b + r$, the value of a in terms of b and r can be expressed as

- 1) $\frac{b}{r} + 1$
- 2) $\frac{1+b}{r}$
- 3) $\frac{b+r}{1+r}$
- 4) $\frac{1+b}{r+b}$

53 2009_06_IA_14 Sets: Replacement

Which value of x is in the solution set of

$$\frac{4}{3}x + 5 < 17?$$

- 1) 8
- 2) 9
- 3) 12
- 4) 16

54 2009_06_IA_15 Graphic Representation of Data

The box-and-whisker plot below represents students' scores on a recent English test.

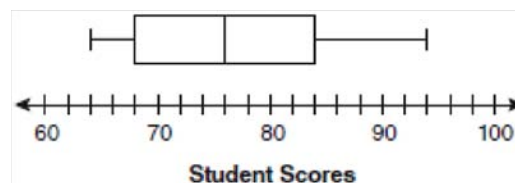

What is the value of the upper quartile?

- 1) 68
- 2) 76
- 3) 84
- 4) 94

55 2009_06_IA_16 Rationals: Undefined

Which value of n makes the expression $\frac{5n}{2n-1}$ undefined?

- 1) 1
- 2) 0
- 3) $-\frac{1}{2}$
- 4) $\frac{1}{2}$

56 2009_06_IA_17 Systems: Writing

At Genesee High School, the sophomore class has 60 more students than the freshman class. The junior class has 50 fewer students than twice the students in the freshman class. The senior class is three times as large as the freshman class. If there are a total of 1,424 students at Genesee High School, how many students are in the freshman class?

- 1) 202
- 2) 205
- 3) 235
- 4) 236

57 2009_06_IA_18 Quadratics: Find Vertex Given Equation

What are the vertex and axis of symmetry of the parabola $y = x^2 - 16x + 63$?

- 1) vertex: $(8, -1)$; axis of symmetry: $x = 8$
- 2) vertex: $(8, 1)$; axis of symmetry: $x = 8$
- 3) vertex: $(-8, -1)$; axis of symmetry: $x = -8$
- 4) vertex: $(-8, 1)$; axis of symmetry: $x = -8$

58 2009_06_IA_19 Functions: Defining

Which statement is true about the relation shown on the graph below?

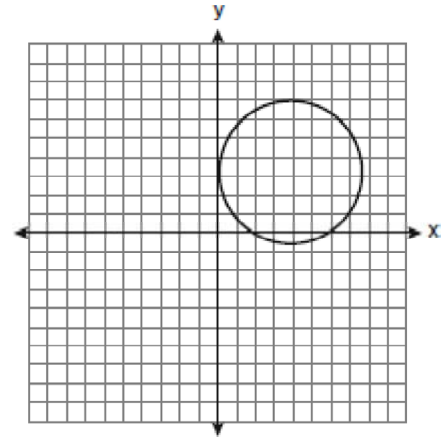

- 1) It is a function because there exists one x -coordinate for each y -coordinate.
- 2) It is a function because there exists one y -coordinate for each x -coordinate.
- 3) It is *not* a function because there are multiple y -values for a given x -value.
- 4) It is *not* a function because there are multiple x -values for a given y -value.

Which graph represents the solution of $3y - 9 \leq 6x$?

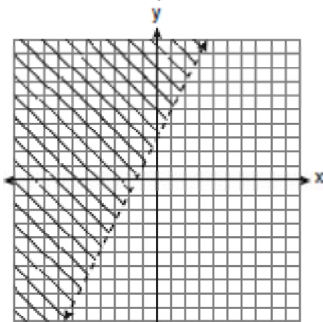
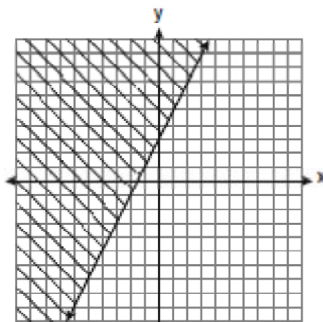
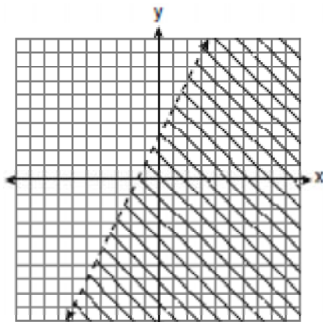
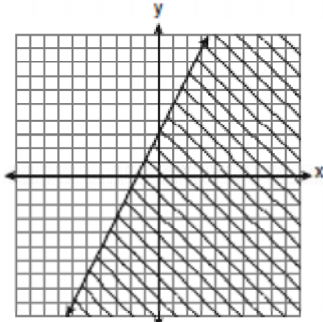

Which expression represents $\frac{x^2 - 2x - 15}{x^2 + 3x}$ in

simplest form?

- 1) -5
- 2) $\frac{x-5}{x}$
- 3) $\frac{-2x-5}{x}$
- 4) $\frac{-2x-15}{3x}$

What is an equation of the line that passes through the point $(4, -6)$ and has a slope of -3 ?

- 1) $y = -3x + 6$
- 2) $y = -3x - 6$
- 3) $y = -3x + 10$
- 4) $y = -3x + 14$

When $4x^2 + 7x - 5$ is subtracted from $9x^2 - 2x + 3$, the result is

- 1) $5x^2 + 5x - 2$
- 2) $5x^2 - 9x + 8$
- 3) $-5x^2 + 5x - 2$
- 4) $-5x^2 + 9x - 8$

63 2009_06_IA_24 Quadratics: Graphing

The equation $y = x^2 + 3x - 18$ is graphed on the set of axes below.

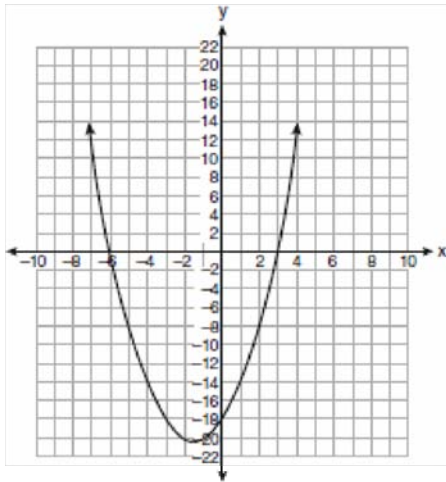

Based on this graph, what are the roots of the equation $x^2 + 3x - 18 = 0$?

- 1) -3 and 6
- 2) 0 and -18
- 3) 3 and -6
- 4) 3 and -18

64 2009_06_IA_25 Systems: Linear

What is the value of the y -coordinate of the solution to the system of equations $x + 2y = 9$ and $x - y = 3$?

- 1) 6
- 2) 2
- 3) 3
- 4) 5

65 2009_06_IA_26 Numbers: Properties of Real

What is the additive inverse of the expression $a - b$?

- 1) $a + b$
- 2) $a - b$
- 3) $-a + b$
- 4) $-a - b$

66 2009_06_IA_27 Scientific Notation

What is the product of 12 and 4.2×10^6 expressed in scientific notation?

- 1) 50.4×10^6
- 2) 50.4×10^7
- 3) 5.04×10^6
- 4) 5.04×10^7

67 2009_06_IA_28 Error

To calculate the volume of a small wooden cube, Ezra measured an edge of the cube as 2 cm. The actual length of the edge of Ezra's cube is 2.1 cm. What is the relative error in his volume calculation to the nearest hundredth?

- 1) 0.13
- 2) 0.14
- 3) 0.15
- 4) 0.16

68 2009_06_IA_29 Rationals: Addition and Subtraction of

What is $\frac{6}{4a} - \frac{2}{3a}$ expressed in simplest form?

- 1) $\frac{4}{a}$
- 2) $\frac{5}{6a}$
- 3) $\frac{8}{7a}$
- 4) $\frac{10}{12a}$

69 2009_06_IA_30 Set Theory

The set $\{11, 12\}$ is equivalent to

- 1) $\{x \mid 11 < x < 12, \text{ where } x \text{ is an integer}\}$
- 2) $\{x \mid 11 < x \leq 12, \text{ where } x \text{ is an integer}\}$
- 3) $\{x \mid 10 \leq x < 12, \text{ where } x \text{ is an integer}\}$
- 4) $\{x \mid 10 < x \leq 12, \text{ where } x \text{ is an integer}\}$

70 2009_06_IA_31 Combinatorics: Permutations

Determine how many three-letter arrangements are possible with the letters $A, N, G, L,$ and E if no letter may be repeated.

71 2009_06_IA_32 Quadratics: Difference of Perfect Squares

Factor completely: $4x^3 - 36x$

72 2009_06_IA_33 Probability: Conditional
 Some books are laid on a desk. Two are English, three are mathematics, one is French, and four are social studies. Theresa selects an English book and Isabelle then selects a social studies book. Both girls take their selections to the library to read. If Truman then selects a book at random, what is the probability that he selects an English book?

73 2009_06_IA_34 Polygons and Circles: Inscribed
 In the diagram below, the circumference of circle O is 16π inches. The length of \overline{BC} is three-quarters of the length of diameter \overline{AD} and $CE = 4$ inches. Calculate the area, in square inches, of trapezoid $ABCD$.

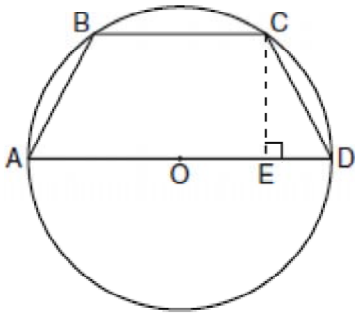

74 2009_06_IA_35 Notes and Interest
 A bank is advertising that new customers can open a savings account with a $3\frac{3}{4}\%$ interest rate compounded annually. Robert invests \$5,000 in an account at this rate. If he makes no additional deposits or withdrawals on his account, find the amount of money he will have, to the *nearest cent*, after three years.

75 2009_06_IA_36 Graphic Representation of Data
 The table below shows the number of prom tickets sold over a ten-day period.

Day (x)	1	2	5	7	10
Number of Prom Tickets Sold (y)	30	35	55	60	70

Plot these data points on the coordinate grid below. Use a consistent and appropriate scale. Draw a reasonable line of best fit and write its equation.

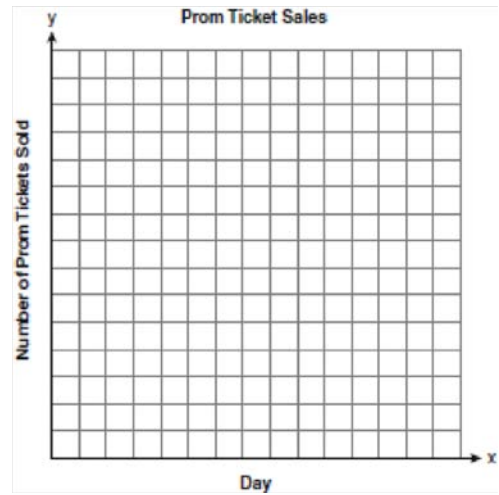

76 2009_06_IA_37 Trigonometry: Finding Sides

A stake is to be driven into the ground away from the base of a 50-foot pole, as shown in the diagram below. A wire from the stake on the ground to the top of the pole is to be installed at an angle of elevation of 52° .

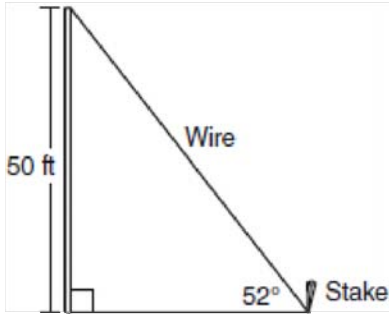

How far away from the base of the pole should the stake be driven in, to the *nearest foot*?
 What will be the length of the wire from the stake to the top of the pole, to the *nearest foot*?

77 2009_06_IA_38 Graphic Representation: Histograms and Tables

The Fahrenheit temperature readings on 30 April mornings in Stormville, New York, are shown below.

$41^\circ, 58^\circ, 61^\circ, 54^\circ, 49^\circ, 46^\circ, 52^\circ, 58^\circ, 67^\circ, 43^\circ,$
 $47^\circ, 60^\circ, 52^\circ, 58^\circ, 48^\circ,$
 $44^\circ, 59^\circ, 66^\circ, 62^\circ, 55^\circ, 44^\circ, 49^\circ, 62^\circ, 61^\circ, 59^\circ,$
 $54^\circ, 57^\circ, 58^\circ, 63^\circ, 60^\circ$

Using the data, complete the frequency table below.

Interval	Tally	Frequency
40–44		
45–49		
50–54		
55–59		
60–64		
65–69		

On the grid below, construct and label a frequency histogram based on the table.

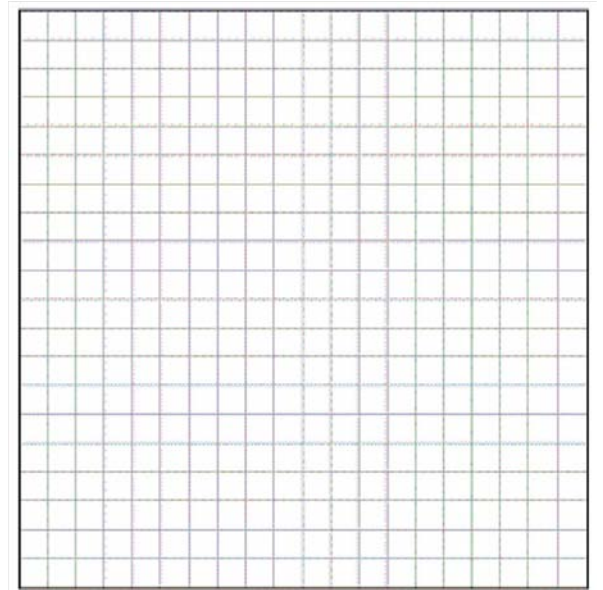

78 2009_06_IA_39 Systems: Quadratic Linear

On the set of axes below, solve the following system of equations graphically for all values of x and y .

$$y = x^2 - 6x + 1$$

$$y + 2x = 6$$

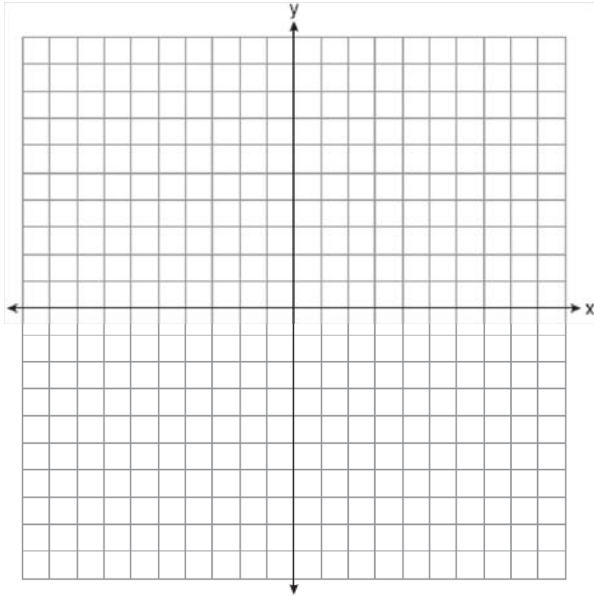

79 2009_08_IA_01 Equations and Expressions: Modeling

If h represents a number, which equation is a correct translation of "Sixty more than 9 times a number is 375"?

- 1) $9h = 375$
- 2) $9h + 60 = 375$
- 3) $9h - 60 = 375$
- 4) $60h + 9 = 375$

80 2009_08_IA_02 Quadratics: Difference of Perfect Squares

Which expression is equivalent to $9x^2 - 16$?

- 1) $(3x + 4)(3x - 4)$
- 2) $(3x - 4)(3x - 4)$
- 3) $(3x + 8)(3x - 8)$
- 4) $(3x - 8)(3x - 8)$

81 2009_08_IA_03 Exponents: Operations with

Which expression represents $(3x^2y^4)(4xy^2)$ in simplest form?

- 1) $12x^2y^8$
- 2) $12x^2y^6$
- 3) $12x^3y^8$
- 4) $12x^3y^6$

82 2009_08_IA_04 Inequalities: Writing Systems of

An online music club has a one-time registration fee of \$13.95 and charges \$0.49 to buy each song. If Emma has \$50.00 to join the club and buy songs, what is the maximum number of songs she can buy?

- 1) 73
- 2) 74
- 3) 130
- 4) 131

83 2009_08_IA_05 Probability: Conditional

The local ice cream stand offers three flavors of soft-serve ice cream: vanilla, chocolate, and strawberry; two types of cone: sugar and wafer; and three toppings: sprinkles, nuts, and cookie crumbs. If Dawn does not order vanilla ice cream, how many different choices can she make that have one flavor of ice cream, one type of cone, and one topping?

- 1) 7
- 2) 8
- 3) 12
- 4) 18

- 84 2009_08_IA_06 Triangles: Pythagoras
Nancy's rectangular garden is represented in the diagram below.

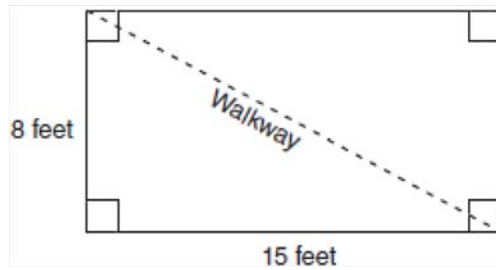

If a diagonal walkway crosses her garden, what is its length, in feet?

- 1) 17
 - 2) 22
 - 3) $\sqrt{161}$
 - 4) $\sqrt{529}$
- 85 2009_08_IA_07 Probability: Theoretical
The spinner below is divided into eight equal regions and is spun once. What is the probability of *not* getting red?

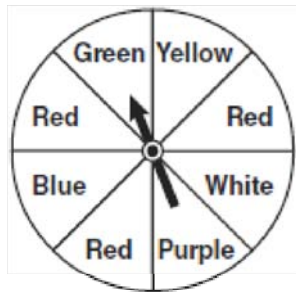

- 1) $\frac{3}{5}$
- 2) $\frac{3}{8}$
- 3) $\frac{5}{8}$
- 4) $\frac{7}{8}$

- 86 2009_08_IA_08 Analysis of Data
Which relationship can best be described as causal?
- 1) height and intelligence
 - 2) shoe size and running speed
 - 3) number of correct answers on a test and test score
 - 4) number of students in a class and number of students with brown hair

- 87 2009_08_IA_09 Equations: Simple with Fractional Expressions

Solve for x : $\frac{3}{5}(x + 2) = x - 4$

- 1) 8
 - 2) 13
 - 3) 15
 - 4) 23
- 88 2009_08_IA_10 Analysis of Data
Erica is conducting a survey about the proposed increase in the sports budget in the Hometown School District. Which survey method would likely contain the most bias?
- 1) Erica asks every third person entering the Hometown Grocery Store.
 - 2) Erica asks every third person leaving the Hometown Shopping Mall this weekend.
 - 3) Erica asks every fifth student entering Hometown High School on Monday morning.
 - 4) Erica asks every fifth person leaving Saturday's Hometown High School football game.

- 89 2009_08_IA_11 Parallel and Perpendicular Lines
Which equation represents a line parallel to the x -axis?

- 1) $y = -5$
- 2) $y = -5x$
- 3) $x = 3$
- 4) $x = 3y$

90 2009_08_IA_12 Set Theory

Given:

$A = \{\text{All even integers from 2 to 20, inclusive}\}$

$B = \{10, 12, 14, 16, 18\}$

What is the complement of set B within the universe of set A ?

- 1) $\{4, 6, 8\}$
- 2) $\{2, 4, 6, 8\}$
- 3) $\{4, 6, 8, 20\}$
- 4) $\{2, 4, 6, 8, 20\}$

91 2009_08_IA_13 Sets: Replacement

Which value of x is in the solution set of the inequality $-2(x - 5) < 4$?

- 1) 0
- 2) 2
- 3) 3
- 4) 5

92 2009_08_IA_14 Trigonometry: Finding Sides

A tree casts a 25-foot shadow on a sunny day, as shown in the diagram below.

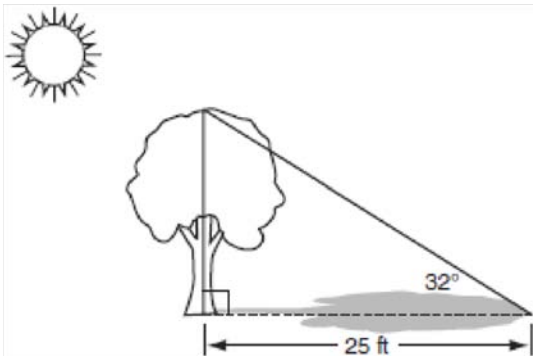

If the angle of elevation from the tip of the shadow to the top of the tree is 32° , what is the height of the tree to the nearest tenth of a foot?

- 1) 13.2
- 2) 15.6
- 3) 21.2
- 4) 40.0

93 2009_08_IA_15 Slope

What is the slope of the line that passes through the points $(-5, 4)$ and $(15, -4)$?

- 1) $-\frac{2}{5}$
- 2) 0
- 3) $-\frac{5}{2}$
- 4) undefined

94 2009_08_IA_16 Quadratics: Graphing

The equation $y = -x^2 - 2x + 8$ is graphed on the set of axes below.

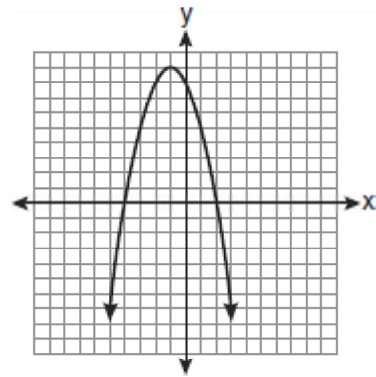

Based on this graph, what are the roots of the equation $-x^2 - 2x + 8 = 0$?

- 1) 8 and 0
- 2) 2 and -4
- 3) 9 and -1
- 4) 4 and -2

95 2009_08_IA_17 Rationals: Addition and Subtraction of

What is the sum of $\frac{3}{2x}$ and $\frac{4}{3x}$ expressed in simplest form?

- 1) $\frac{12}{6x^2}$
- 2) $\frac{17}{6x}$
- 3) $\frac{7}{5x}$
- 4) $\frac{17}{12x}$

- 96 2009_08_IA_18 Rationals: Undefined
Which value of x makes the expression

$$\frac{x^2 - 9}{x^2 + 7x + 10} \text{ undefined?}$$

- 1) -5
- 2) 2
- 3) 3
- 4) -3

- 97 2009_08_IA_19 Functions: Defining
Which relation is *not* a function?

- 1) $\{(1, 5), (2, 6), (3, 6), (4, 7)\}$
- 2) $\{(4, 7), (2, 1), (-3, 6), (3, 4)\}$
- 3) $\{(-1, 6), (1, 3), (2, 5), (1, 7)\}$
- 4) $\{(-1, 2), (0, 5), (5, 0), (2, -1)\}$

- 98 2009_08_IA_20 Systems: Linear
What is the value of the y -coordinate of the solution to the system of equations $x - 2y = 1$ and $x + 4y = 7$?

- 1) 1
- 2) -1
- 3) 3
- 4) 4

- 99 2009_08_IA_21 Quadratics: Solving by Factoring
The solution to the equation $x^2 - 6x = 0$ is

- 1) 0 , only
- 2) 6 , only
- 3) 0 and 6
- 4) $\pm\sqrt{6}$

- 100 2009_08_IA_22 Radicals: Simplifying
When $5\sqrt{20}$ is written in simplest radical form, the result is $k\sqrt{5}$. What is the value of k ?

- 1) 20
- 2) 10
- 3) 7
- 4) 4

- 101 2009_08_IA_23 Absolute Value
What is the value of the expression $|-5x + 12|$ when $x = 5$?

- 1) -37
- 2) -13
- 3) 13
- 4) 37

- 102 2009_08_IA_24 Polygons and Circles: Compositions of
A playground in a local community consists of a rectangle and two semicircles, as shown in the diagram below.

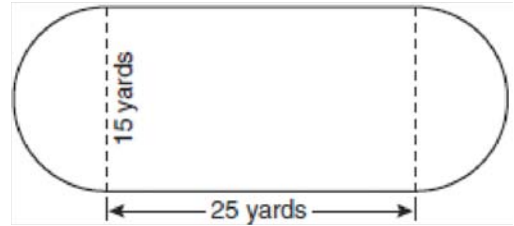

Which expression represents the amount of fencing, in yards, that would be needed to completely enclose the playground?

- 1) $15\pi + 50$
- 2) $15\pi + 80$
- 3) $30\pi + 50$
- 4) $30\pi + 80$

- 103 2009_08_IA_25 Graphs: Identifying Equations of
Which equation is represented by the graph below?

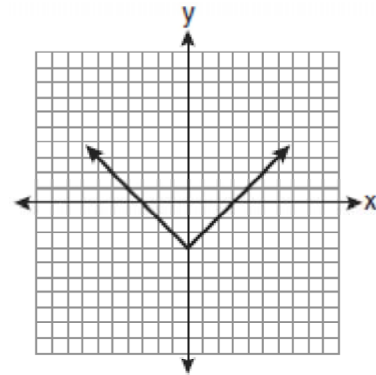

- 1) $y = x^2 - 3$
- 2) $y = (x - 3)^2$
- 3) $y = |x| - 3$
- 4) $y = |x - 3|$

- 104 2009_08_IA_26 Error
Carrie bought new carpet for her living room. She calculated the area of the living room to be 174.2 square feet. The actual area was 149.6 square feet. What is the relative error of the area to the *nearest ten-thousandth*?
- 1) 0.1412
 - 2) 0.1644
 - 3) 1.8588
 - 4) 2.1644

- 105 2009_08_IA_27 Equations: Writing Linear
What is an equation of the line that passes through the point $(3, -1)$ and has a slope of 2?
- 1) $y = 2x + 5$
 - 2) $y = 2x - 1$
 - 3) $y = 2x - 4$
 - 4) $y = 2x - 7$

- 106 2009_08_IA_28 Consecutive Integers
The ages of three brothers are consecutive even integers. Three times the age of the youngest brother exceeds the oldest brother's age by 48 years. What is the age of the youngest brother?
- 1) 14
 - 2) 18
 - 3) 22
 - 4) 26

- 107 2009_08_IA_29 Exponential Functions and Equations
Cassandra bought an antique dresser for \$500. If the value of her dresser increases 6% annually, what will be the value of Cassandra's dresser at the end of 3 years to the *nearest dollar*?
- 1) \$415
 - 2) \$590
 - 3) \$596
 - 4) \$770

- 108 2009_08_IA_30 Graphic Representation of Data
The number of hours spent on math homework each week and the final exam grades for twelve students in Mr. Dylan's algebra class are plotted below.

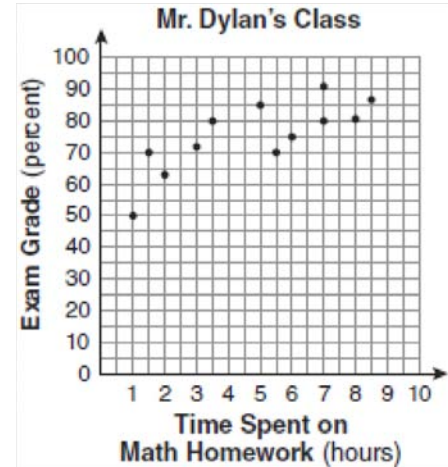

Based on a line of best fit, which exam grade is the best prediction for a student who spends about 4 hours on math homework each week?

- 1) 62
- 2) 72
- 3) 82
- 4) 92

- 109 2009_08_IA_31 Definitions: Algebra

Chad complained to his friend that he had five equations to solve for homework. Are all of the homework problems equations? Justify your answer.

Math Homework

1. $3x^2 \cdot 2x^4$
2. $5 - 2x = 3x$
3. $3(2x + 7)$
4. $7x^2 + 2x - 3x^2 - 9$
5. $\frac{2}{3} = \frac{x+2}{6}$

Name Chad

- 110 2009_08_IA_32 Volume

The diagram below represents Joe's two fish tanks.

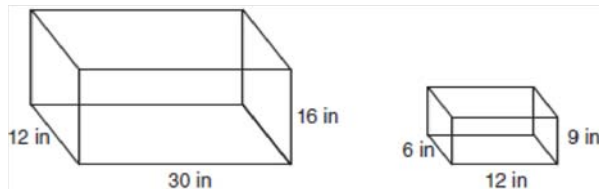

Joe's larger tank is completely filled with water. He takes water from it to completely fill the small tank. Determine how many cubic inches of water will remain in the larger tank.

- 111 2009_08_IA_33 Probability: Theoretical

Clayton has three fair coins. Find the probability that he gets two tails and one head when he flips the three coins.

- 112 2009_08_IA_34 Quadratics: Find Vertex Given Equation

Find algebraically the equation of the axis of symmetry and the coordinates of the vertex of the parabola whose equation is $y = -2x^2 - 8x + 3$.

- 113 2009_08_IA_35 Percent

At the end of week one, a stock had increased in value from \$5.75 a share to \$7.50 a share. Find the percent of increase at the end of week one to the nearest tenth of a percent. At the end of week two, the same stock had decreased in value from \$7.50 to \$5.75. Is the percent of decrease at the end of week two the same as the percent of increase at the end of week one? Justify your answer.

- 114 2009_08_IA_36 Rate, Time and Distance

The chart below compares two runners.

Runner	Distance, in miles	Time, in hours
Greg	11	2
Dave	16	3

Based on the information in this chart, state which runner has the faster rate. Justify your answer.

- 115 2009_08_IA_37 Fractions: Complex

Express in simplest form: $\frac{2x^2 - 8x - 42}{6x^2} \div \frac{x^2 - 9}{x^2 - 3x}$

116 2009_08_IA_38 Systems: Linear

On the grid below, solve the system of equations graphically for x and y .

$$4x - 2y = 10$$

$$y = -2x - 1$$

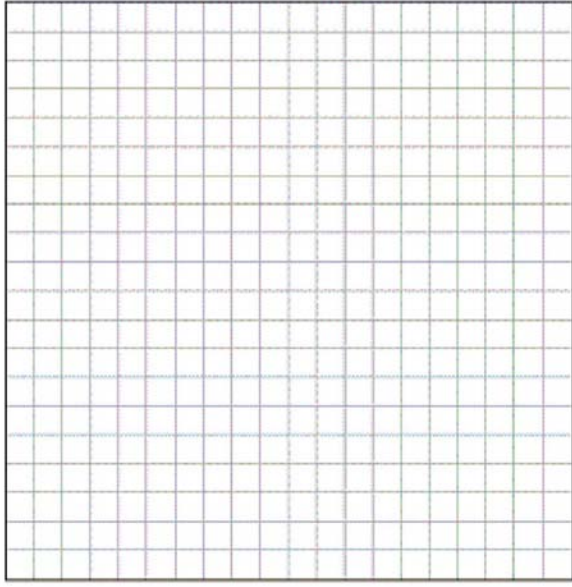

117 2009_08_IA_39 Graphic Representation of Data

The test scores from Mrs. Gray's math class are shown below.

72, 73, 66, 71, 82, 85, 95, 85, 86, 89, 91, 92

Construct a box-and-whisker plot to display these data.

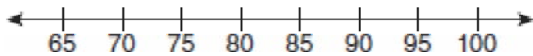

IN - The Intermediate Algebra Curriculum (1909-1940)

- 1 1909_01_IN_01 Quadratics: Solving by Factoring
Solve as a quadratic equation
 $x^2 + 2x + 10 - \sqrt{x^2 + 2x + 10} = 20$
Verify *two* values of x obtained.
- 2 1909_01_IN_02 Systems: Other Nonlinear
A laborer received \$15 for a certain number of days work; if he had received 25 cents less a day, it would have taken him 2 days longer to earn the same amount. How long did he work?
- 3 1909_01_IN_03 Systems: Other Nonlinear
Solve
$$\begin{cases} x + y + \sqrt{x + y} = 12 \\ x - y + \sqrt{x - y} = 2 \end{cases}$$
- 4 1909_01_IN_04 Polynomials: Factoring
Factor three of the following: $x^4 + 4$;
 $m^2 - 2mn + n^2 + 5m - 5n$;
 $a^2 - x^2 - m^2 - 2ab + 2mx + b^2$;
 $x^6 + 7x^4 - 7x^3 - 49x^2 + 6x + 42$
- 5 1909_01_IN_05 Radicals: Operations with
Find the value of $\frac{\sqrt{a} - \sqrt{x}}{\sqrt{a - x}}$ when $x = a$. Interpret your result.
- 6 1909_01_IN_06 Radicals: Square Roots
Extract the square root of each of two of the following: $7 + 4\sqrt{3}$; $3 + \sqrt{5}$; $2a + 2\sqrt{a^2 - b^2}$
- 7 1909_01_IN_07 Radicals: Operations with
Simplify two of the following: $\left(3^3\sqrt{\frac{1}{8}}\right)^2$,
 $\sqrt[3]{\frac{a}{bd}} \cdot \sqrt{\frac{a}{bd}}$; $\frac{5\sqrt{11}}{2\sqrt{33}} - \frac{7\sqrt{33}}{5}$;
 $\sqrt{24} + \sqrt{64} - \sqrt{6}$
- 8 1909_01_IN_08 Exponents: Operations with
Multiply $a^{\frac{3}{4}} + a^{\frac{3}{8}} - 3a^{\frac{1}{4}} + 1 - a^{-\frac{1}{4}} + a^{-\frac{3}{8}}$ by
 $a^{\frac{3}{4}} - 2 + a^{-\frac{1}{2}}$
- 9 1909_01_IN_09 Progressions: Arithmetic
Derive the formula for the last term and for the sum of an arithmetical progression.
- 10 1909_01_IN_10 Progressions: Geometric
In a geometrical progression $a = 2$, $r = \frac{1}{2}$, $S = \frac{5}{36}$;
find s and n .
- 11 1909_01_IN_11 Systems: Writing
What two numbers whose difference is d are to each other as $a:b$?
- 12 1909_06_IN_01 Equations and Expressions: Using Substitution in
Solve $\frac{ax + b}{cx + d} = 1$. Determine the value of x when $a = c$, when $b = d$, when $a = c$ and $b = d$
- 13 1909_06_IN_02a Radicals: Operations with
Simplify $\frac{3 + 2\sqrt{-1}}{3 - 2\sqrt{-1}}$; $(x + 3\sqrt{-1})(x - 4\sqrt{-1})$
- 14 1909_06_IN_02b Equations and Expressions: Using Substitution in
Find the value of $x^2 - 6x + 14$ if $x = 3 - \sqrt{-5}$
- 15 1909_06_IN_03 Radicals: N-Roots
a. Find the square root of $8 + \sqrt{(a)^2}$
b. Without extracting the roots determine which is the greater $\sqrt{7}$ or $\sqrt[3]{18}$

- 16 1909_06_IN_04 Radicals: Solving
Free the following equation from radicals and find the value of x when $q = 0$:

$$x = -\frac{1}{2}q + \sqrt{-\frac{3}{4}q^2 + \sqrt{q^4 + r^4}}$$

- 17 1909_06_IN_05 Trigonometry: Finding Sides
The hypotenuse of a right triangle is 20; the sum of the other two sides is 28. Find the lengths of the sides.

- 18 1909_06_IN_06 Progressions: Geometric
In a geometric progression the sum of the first and second terms is 12; the sum of the third and fourth terms is 108. Find (a) the ratio, (b) the sum of the first seven terms.

- 19 1909_06_IN_07 Progressions: Arithmetic
The sum of all the even integers from 2 to a certain number inclusive is 702; find the last of these integers.

- 20 1909_06_IN_08 Systems: Quadratic Linear
Plot the graphs of the following system of equations:

$$x^2 + y^2 = 4$$

$$3x - 2y = 6$$

From the graphs find the approximate values of x and y that satisfy both equations.

- 21 1909_06_IN_09 Quadratics: Noninteger Solutions
Find the roots of the equation $ax^2 + bx + c = 0$ and discuss their values when c and a are both positive.

- 22 1909_06_IN_10 Quadratics: $a > 1$
Solve as a quadratic $\left(x - \frac{1}{x}\right)^2 + \frac{5}{6}\left(x - \frac{1}{x}\right) = 1$

- 23 1920_01_IN_01 Factors: Prime
Find the prime factors of *each* of the following:
 $16y^4 = 0.0081$
 $(2x - 3)^2 + 3(2x - 3) - 10$
 $4a^2 - 16b^2 + 4a + 1$
 $x^3 + x^2 - 14x - 24$

- 24 1920_01_IN_02 Fractions: Complex
In *each* of the following perform the indicated operations and write the result in its simplest form:

$$\frac{c^2 - 22}{c^2 - 2c - 8} + \frac{c - 5}{4 - c};$$

$$\frac{x^2 - 4x + 4}{10x - 21} \div \frac{x^2 + x - 6}{10x^2 + 9x - 63}$$

- 25 1920_01_IN_03 Radicals: Rationalizing Denominators
Rationalize the denominator in *each* of the following and express the result in its simplest form:

$$\frac{6}{\sqrt[3]{4a^2}}; \quad \frac{2\sqrt{3} + 3\sqrt{2}}{\sqrt{6} + \sqrt{3}}$$

- 26 1920_01_IN_04 Quadratics: Sum and Product of Roots
a Without solving, show how to find the sum of the roots and the product of the roots of the equation $4x^2 - 12x = 3$
b Determine from the result whether $\frac{3}{2} - \sqrt{3}$ and $\frac{3}{2} + \sqrt{3}$ are the roots of this equation.

- 27 1920_01_IN_05 Polynomials: Multiplication and Division of
a Multiply $2x^2 - 3x + 5$ by $3x^2 + 2x^{-1} - 6$
b Express the result in descending powers of x .
c Write this result, using positive exponents only.

- 28 1920_01_IN_06 Quadratics: Solving
A piece of tin 9" by 12" is to be made into an open box with a base area of 60 square inches by cutting equal squares from the four corners and then bending up the edges; what is the size, to the nearest tenth of an inch, of the square cut from each corner?

- 29 1920_01_IN_07 Binomial Expansions
Writing $(1.06)^6$ as $(1 + .06)^6$, (a) expand by the binomial formula, (b) find the value to *two* decimal places. [Carry the work far enough to be sure that the terms neglected do not affect the second decimal place.] In this example what terms will be neglected?

- 30 1920_01_IN_08 Exponents: Operations with
 a Unite into a single term:

$$6\sqrt{2\frac{2}{3}a^3 - 2(24ab)\frac{1}{2}} + a\sqrt{54a}$$
- b Evaluate $(0.125)^{-\frac{2}{3}} + \frac{3}{2 + 2^{-1}}$
- c Evaluate 0.6×32^0 ; 0.8×4^{-2} ; $12 \times 9^{-\frac{1}{2}}$
- 31 1920_01_IN_09a Progressions: Arithmetic
 How many terms must constitute the series $7 + 10 + 13 + \dots$ in order that the sum may be 242?
- 32 1920_01_IN_09b Logarithms
 (1) Multiply, using logarithms: 27.3×0.96
 (2) Solve for n : $4 = (1.04)^n$
- 33 1920_01_IN_10 Rate, Time and Distance
 Two trains run at uniform rates over the same 120 miles of rail; one of the trains travels 5 miles an hour faster than the other and takes 20 minutes less time to run the distance. Find the rate of the faster train.
- 34 1920_01_IN_11 Systems: Quadratic Linear
 Solve the following set of equations, correctly group your answers and check either group:

$$\begin{aligned} x^2 + y^2 &= 20 \\ x + 2y &= 5 \end{aligned}$$
- 35 1920_01_IN_12 Systems: Quadratic Linear
 Represent graphically the following set of equations and from the graph draw a conclusion as to the nature of the solutions to this set:

$$\begin{aligned} y^2 &= 8x + 1 \\ 4x - 5y &= -13 \end{aligned}$$
- 36 1920_09_IN_01 Factors: Prime
 Find the prime factors of *each* of the following:

$$\begin{aligned} 10a^2c - 15a^2c^2 - 70ac^2 \\ x^3 - 8x^2 + 17x - 10 \\ x^4y^4 - 64 \\ 4k^{2x} - 20k^xy^k + 25y^{2k} \end{aligned}$$
- 37 1920_09_IN_01 Factors: Prime
 Find the prime factors of *each* of the following:

$$\begin{aligned} 10a^2c - 15a^2c^2 - 70ac^2 \\ x^3 - 8x^2 + 17x - 10 \\ x^4y^4 - 64 \\ 4k^{2x} - 20k^xy^k + 25y^{2k} \end{aligned}$$
- 38 1920_09_IN_02 Exponents: Operations with
 a Solve without the use of tables: $\frac{1}{2}x^{-\frac{2}{3}} = 2$
 b Divide $x^4 + x^4 - 2$ by $x^2 - x^{-2}$
- 39 1920_09_IN_03 Equations: Forming Quadratics from Roots
 a State *two* distinct ways of forming an equation when the roots are given. Using *one* of these methods, form the equation whose roots are $2 + \sqrt{2}$ and $2 - \sqrt{2}$
 b What must be the value of k in the equation $3x^2 - 6x - 17 + k = 0$ to make both roots equal?
 Leave on the paper all work for both *a* and *b*.
- 40 1920_09_IN_04 Systems: Other Nonlinear
 Solve the following, correctly group your answers and check *one* set of answers:

$$\begin{cases} 4x^2 - 13xy + 9y^2 = 9 \\ xy - y^2 = 3 \end{cases}$$
- 41 1920_09_IN_05 Systems: Quadratic Linear
 Represent graphically each equation in the following set and from the graph determine the common solutions:

$$y^2 = 3x + 9; \quad 2x - 3y = 0$$
- 42 1920_09_IN_06a Progressions: Arithmetic and Geometric
 Three numbers whose sum is 24 are in arithmetic progression, but if 3, 4, and 7 are added to these respectively, the result forms a geometric progression; find the numbers. Leave all work on paper.

- 43 1920_09_IN_06b Logarithms
By the use of logarithms find the value of

$$\sqrt[3]{\frac{.0632 \times 176.25}{(.824)^3}}$$
- 44 1920_09_IN_07 Exponents: Operations with
Simplify $\left(\frac{4}{3}\right)^{\frac{1}{2}} - \left(\frac{2}{3}\right)^{-\frac{3}{2}} + \sqrt{\left(\frac{8}{27}\right)^{-1}} + \sqrt{1.35} - \sqrt[4]{\left(1\frac{2}{3}\right)^{-2}}$
Multiply $2\sqrt{6} - 3\sqrt{5}$ by $4\sqrt{3} - \sqrt{10}$
- 45 1920_09_IN_08 Equations: Literal
In the formula $P = \frac{nd^2}{2.3}$
a Solve for d .
b Find the value of d to the *nearest tenth* when $P = 51.84$ and $n = 4.32$.
- 46 1920_09_IN_09 Quadratics: Noninteger Solutions
The dimensions of a rectangle are 5' by 2'. Find the amounts to the *nearest hundredth* by which each dimension must be changed in order that both area and perimeter shall be doubled.
- 47 1920_09_IN_10 Rate, Time and Distance
A boatman trying to row up a river drifted back at the rate of 2 miles per hour, but when rowing down the river his rate was $12\frac{1}{2}$ miles per hour; find the rate of the current.
- 48 1930_01_IN_01 Polynomials: Factoring
Factor $x^{2a} - x^a - 6$
- 49 1930_01_IN_02 Fractions: Complex
Simplify $\left(a + \frac{1}{b}\right)\left(b - \frac{1}{a}\right) \div \frac{a^2b^2 - 1}{3ab}$
- 50 1930_01_IN_03 Equations: Degrees of
If the equation $x + \frac{1}{x} = 2$ is cleared of fractions, what is the degree of the resulting equation?
- 51 1930_01_IN_04 Quadratics: Sum and Product of Roots
If $x^2 - 5x + 2 = 0$, by what amount does the sum of the roots exceed the product of the roots?
- 52 1930_01_IN_05 Quadratics: Using the Discriminant
Find the value of the discriminant of the equation $4x^2 - 3x - 1 = 0$
- 53 1930_01_IN_06 Equations: Forming Quadratics from Roots
If one root of $x^2 - 2x + k = 0$ is zero, what is the value of k ?
- 54 1930_01_IN_07 Quadratics: Using the Discriminant
Are the roots of the equation $x(x-4) = 4$ equal?
[Answer *yes* or *no*]
- 55 1930_01_IN_08 Radicals: Operations with
Simplify $(\sqrt{2} - \sqrt{3})^2 + (\sqrt{2} + \sqrt{3})^2$
- 56 1930_01_IN_09 Exponents
Simplify $8^{\frac{2}{3}} \times 16^{-\frac{3}{4}} \times 2^0$
- 57 1930_01_IN_10 Logarithms
Find the value of $\log 7132 - \log 7.132$
- 58 1930_01_IN_11 Logarithms
Given $\log n = 9.3316 - 10$; what is the characteristic?

- 59 1930_01_IN_12 Ratio
If $x:y = 2:3$, find the value of $\frac{x^2}{y^2}$
- 60 1930_01_IN_13 Equations: Literal
Solve for s in the following formula: $t = \sqrt{\frac{2s}{g}}$
- 61 1930_01_IN_14 Rate, Time and Distance
A man must travel a distance of 100 miles. During the first 2 hours he travels at the rate of m miles an hour. At what rate must he then travel to complete his journey in 3 hours more?
- 62 1930_01_IN_15 Definitions: Algebra
The coordinates of a point P are $x = 3$, $y = 4$; what is the abscissa of the point?
- 63 1930_01_IN_16 Quadratics: Using the Discriminant
Does the graph of $y = x^2 + 1$ cut the x -axis?
[Answer *yes* or *no*]
- 64 1930_01_IN_17 Progressions: Geometric
What is the *fifth* term of a geometric progression whose first and second terms are 2 and 6 respectively?
- 65 1930_01_IN_18 Progressions: Arithmetic
In an arithmetic progression, what is the formula for s in terms of n , a , and d ?
- 66 1930_01_IN_19 Fractions: Complex
Is the value of a positive fraction increased or decreased if the denominator is divided by 2?
- 67 1930_01_IN_20 Quadratics: Find Vertex Given Equation
Is there any value of x for which $x^2 - 2x + 2$ is negative? [Answer *yes* or *no*]
- 68 1930_01_IN_21 Systems: Writing
If three times the larger of two numbers is divided by the smaller, the quotient is 6 and the remainder is 6. If five times the smaller is divided by the larger, the quotient is 2 and the remainder is 3. Find the numbers. [6,4]
- 69 1930_01_IN_22 Quadratics: Solving by Factoring
The inside dimensions of a picture frame are 18 inches by 24 inches. If the area of the frame is 184 square inches, find its width. [6,4]
- 70 1930_01_IN_23 Progressions: Geometric
A ball starting from rest rolls down an inclined plane, passing over 3 inches during the first second, 5 inches during the second second, 7 inches during the third second, etc. How many second will it take the ball to pass over a distance of 120 inches?
[10]
[No credit will be allowed for mere addition of successive distances.]
- 71 1930_01_IN_24 Systems: Other Nonlinear
An edge of one cube exceeds an edge of another cube by 2 inches. If their volumes differ by 98 cubic inches, find an edge of each cube. [4,6]
- 72 1930_01_IN_25a Factorig Polynomials
Factor $x^3 - 17x - 40$ [6]
- 73 1930_01_IN_25b Radicals: Rationalizing Denominators
Rationalize the denominator of the expression $\frac{\sqrt{5}}{\sqrt{5} - 1}$ and compute its value to the *nearest tenth*.
[2,2]
- 74 1930_01_IN_26 Equations: Logarithmic
The formula for the volume of a sphere is $V = \frac{4}{3} \pi R^3$. By the use of logarithms find the radius R of a sphere when $V = 2610$ cubic inches and $\pi = 3.142$ [10]

- 75 1930_01_IN_27 Systems: Linear
Solve the following graphically:
a Through point $P(3, 4)$ draw a straight line parallel to the x -axis. [3]
b Using the same axes as in *a*, draw the graph that represents the equation $2x - y = 4$ [5]
c From the graphs made in answer to *a* and *b*, determine the coordinates of their point of intersection. [2]
- 76 1930_01_IN_28 Systems: Quadratic Linear
The combined area of the two square pieces of tin is 25 square feet. A side of the larger square is 1 foot longer than a side of the smaller square.
a Using x and y as sides of the two squares, write the two equations that express the relations stated above. [2,2]
b Using the same axes, draw the graphs of the equations formed in answer to *a*. [5]
c From the graphs drawn in answer to *b*, determine the side of each square. [1]
- 77 1930_06_IN_01 Equations: Forming Quadratics from Roots
Write the quadratic equation whose roots are 3 and -7.
- 78 1930_06_IN_02 Numbers: Imaginary
Express $2\sqrt{-12}$ in terms of i and simplify.
- 79 1930_06_IN_03 Rationals: Addition and Subtraction of
Simplify: $\frac{3x-4}{x-1} + \frac{2x-3}{1-x}$
- 80 1930_06_IN_04 Polynomials: Factoring
Find the three factors of $x^{a+2} - x^a$
- 81 1930_06_IN_05 Polynomials: Factoring
Write the binomial factor of $x^2 - 5x + 2$
- 82 1930_06_IN_06 Radicals: Operations with
Find the value of $2 \times 8^{\frac{2}{3}} - 4 \times 16^{-\frac{1}{2}}$
- 83 1930_06_IN_07 Radicals: Operations with
Find the value of $\frac{\sqrt{a}}{\sqrt[6]{a^5}} \times a^{-\frac{2}{3}}$
- 84 1930_06_IN_08 Quadratics: Graphing
If $y = x^2 - 5x + 3$, does y increase or decrease as x increases in value from -1 to 2?
- 85 1930_06_IN_09 Quadratics: Using the Discriminant
Determine the character of the roots of $3x - x^2 = 4$
- 86 1930_06_IN_10 Polynomials: Factoring
Factor $12x^2 - x - 6$
- 87 1930_06_IN_11 Points on a Line: Identification of
What is the value of y for the point where the graph of $3x - 2y = 8$ cuts the y -axis?
- 88 1930_06_IN_12 Equations: Literal
Solve for c the formula $m = \sqrt{2a^2 + 2b^2 - c^2}$
- 89 1930_06_IN_13 Logarithms
How many figures or digits are there in the number obtained by multiplying out 3^{50} ? [Log3 = .4771]
- 90 1930_06_IN_14 Radicals: Solving
Solve for x the following equation:
 $4 = x + \sqrt{x^2 - 8}$
- 91 1930_06_IN_15 Radicals: Rationalizing Denominators
Rationalize the denominator of $\frac{11}{2\sqrt{5} + 3}$
- 92 1930_06_IN_16 Logarithms
Express $\log(a\sqrt{b})$ in terms of $\log a$ and $\log b$.
- 93 1930_06_IN_17 Summations
Find the sum of all the positive integers smaller than 1000 that are divisible by 3.

- 94 1930_06_IN_18 Progressions: Geometric
Find the fifth term of the series $2, 3, 4\frac{1}{2}, \dots$
- 95 1930_06_IN_19 Arithmetic: Division
If the dividend is D , the divisor d and the remainder R , express the quotient Q in terms of D , d and R .
- 96 1930_06_IN_20 Systems: Quadratic Linear
From the following set of equations obtain a quadratic equation in x only:
 $x^2 + y^2 = 10$
 $x + y = 7$
- 97 1930_06_IN_21 Triangles: Pythagoras
A and B start from the same point and travel along roads that are at right angles to each other. A travels 4 miles an hour faster than B and at the end of two hours they are 40 miles apart. Find their rates. [6,4]
- 98 1930_06_IN_22 Notes and Interest
Mr. Smith inherited \$25,000, \$5,000 of which is invested in bonds paying 4% annually. He invests part of the remainder in a mortgage that pays 6% annually and the rest in stock paying 7% annually. His total annual income from the three sources is \$1450; how much does he invest in the mortgage? [7,3]
- 99 1930_06_IN_23 Quadratics: Noninteger Solutions
Find to the *nearest tenth* the roots of
 $3x^2 - 3x - 4 = 0$ [10]
- 100 1930_06_IN_24 Notes and Interest
Mrs. Brown puts \$6990 into a savings bank that pays interest at the rate of 4% compounded semiannually. What amount to the nearest dollar will she have in the bank at the end of 7 years? Use the formula $A = P(1 + r)^n$ where A is the amount, P the principal, n the number of interest periods and r the rate of interest for each period.
- 101 1930_06_IN_25 Fractions: Complex
Simplify $\frac{x - \frac{9}{x}}{\frac{6}{x^2} + \frac{1}{x} - 1} \times \left(\frac{2 - x^2}{3x + x^3} + 1 \right)$ [10]
- 102 1930_06_IN_26 Progressions: Arithmetic
Find three numbers in arithmetic progression such that the sum of the first and third is 12 and the product of the first and second is 24. [10]
- 103 1930_06_IN_27 Alligation
A milkman has 1000 quarts of milk that tests 4% butter fat, but the city in which he sells this milk requires only 3% butter fat. How many quarts of cream testing 23% butter fat may be separate from the milk and still satisfy the city requirements? [8,2]
- 104 1930_06_IN_28 Quadratics: Graphing
a. Form a table of values for $y = x^2 - 3x$ by giving all integral values from -1 to 4 inclusive. [2]
b. Draw the graph of the equation in a between the given limits. [5]
Indicate on the graph by the letters P and Q the points from which the roots of the equation $x^2 - 3x = 2$ are read. Estimate these roots to the *nearest tenth*. [3]
- 105 1930_08_IN_01 Quadratics: Sum and Product of Roots
Write the quadratic equation with integral coefficients, the sum of whose roots is $\frac{1}{3}$ and the product of whose roots is $-\frac{2}{3}$
- 106 1930_08_IN_02 Quadratics: Using the Discriminant
What value must y have in order that $x^2 + 2x + 3 = y$ shall be a quadratic equation having equal roots?

- 107 1930_08_IN_03 Progressions: Geometric
Write the general formula for finding the n th term of the series 6, 9, 13 $\frac{1}{2}$
- [Do not substitute numbers in your formula]
- 108 1930_08_IN_04 Quadratics: Using the Discriminant
The roots of a quadratic equation are $3 + \sqrt{-5}$ and $3 - \sqrt{-5}$; is the discriminant positive, zero, or negative?
- 109 1930_08_IN_05 Progressions: Arithmetic
Which term of the progression 3, 7, 11, is 383?
- 110 1930_08_IN_06 Numbers: Imaginary
Express as a single term $3\sqrt{-49} - 4\sqrt{-9}$
- 111 1930_08_IN_07 Points on a Line: Identification of
The graph of $y = 3x^2 - 2x + k$ cuts the x -axis at the point whose abscissa is 3; find the value of k .
- 112 1930_08_IN_08 Radicals: Rationalizing Denominators
Rationalize the denominator of $\frac{8}{3 + \sqrt{5}}$
- 113 1930_08_IN_09 Radicals: Operations with
Express as a single term $2^{\frac{4}{3}} \times 2^{\frac{3}{4}} + 2^{-\frac{2}{3}}$
- 114 1930_08_IN_10 Polynomials: Factoring
Find the trinomial factor of $x^3 - x^2 - 3x + 6$
- 115 1930_08_IN_11 Polynomials: Factoring
Find the trinomial factor of $x^4 + 5x^3 - 24$
- 116 1930_08_IN_12 Logarithms
If $x = \sqrt[n]{10}$, find the value of $\log x^2$
- 117 1930_08_IN_13 Logarithms
Given $y = \log x$; if y is doubled, by what quantity is x multiplied?
- 118 1930_08_IN_14 Radicals: Solving
Solve for x : $3 = x + \sqrt{x^2 - 3}$
- 119 1930_08_IN_15 Exponents: Operations with
Find the value of $8^{\frac{2}{3}} + 3(3^2 + x)^0$
- 120 1930_08_IN_16 Systems: Other Nonlinear
Solve for x :
$$\frac{1}{x} + \frac{1}{y} = 5$$

$$\frac{1}{x^2} - \frac{1}{y^2} = 5$$
- 121 1930_08_IN_17 Rationals: Addition and Subtraction of
Simplify $x^2 - \left(\frac{2x+1}{3}\right) + \left(\frac{3x+1}{6}\right)$
- 122 1930_08_IN_18 Radicals: Operations with
Find the value of $x^2 - 2x$ when $x = 3 - 2\sqrt{2}$
- 123 1930_08_IN_19 Equations and Expressions: Modeling
If p pounds of sugar cost c cents, how many pounds can be bought for d dollars?
- 124 1930_08_IN_20 Equations: Literal
From the two equations, $r = \frac{1}{2}gt^2$ and $v = gt$, derive an equation containing only r , v , and g .

- 125 1930_08_IN_21 Radicals: Solving
Solve for x and check: $\sqrt{x+15} - \sqrt{x} = \frac{10}{\sqrt{x+15}}$
[8, 2]
- 126 1930_08_IN_22 Progressions: Arithmetic
Find three numbers in the ratio 2 : 5 : 7, such that if 7 is subtracted from the second number they will be in arithmetic progression. [7,3]
- 127 1930_08_IN_23 Systems: Writing
A real-estate agent bought a number of acres of land for \$900. He kept 10 acres for himself and sold the remainder at an advance of \$10 an acre. If he received \$1050 for the land he sold, how many acres did he buy? [6,4]
- 128 1930_08_IN_24 Rate
A can do a piece of work in 10 days. After he worked 3 days alone on it, he and B finished the work in $2\frac{1}{3}$ days. How many days would it take B alone to do the piece of work? [7,3]
- 129 1930_08_IN_25 Notes and Interest
What sum of money will amount to \$1476 in 10 years at 6% interest, compounded annually? [Find the answer to the *nearest dollar*.] [10]
- 130 1930_08_IN_26 Quadratics: Solving
Find the roots of $x = \frac{1}{5x-2}$ to the *nearest hundredth*.
- 131 1930_08_IN_27 Systems: Other Nonlinear
On the same set of axes, plot the graphs of $xy = 12$ and $x - y = 1$. From the graph find the common solutions of this pair of equations and indicate the positions of these solutions on the graph. [10]
- 132 1940_01_IN_01 Polynomials: Factoring
The three factors of $x^3 - 9x$ are...
- 133 1940_01_IN_02 Numbers: Imaginary
Expressed in terms of i , $\sqrt{-9}$ is...
- 134 1940_01_IN_03 Slope Intercept Form of a Line
The slope of the line whose equation is $y = 2x + 3$ is...
- 135 1940_01_IN_04 Progressions: Arithmetic
The formula for S , the sum of an arithmetic series, in terms of the first term a , and the last term l and the number of terms n , is $S = \dots$
- 136 1940_01_IN_05 Rationals: Addition and Subtraction of
The sum of $\frac{a}{b}$ and 1, expressed as a single fraction, is...
- 137 1940_01_IN_06 Radicals: Solving
The value of x which satisfies the equation $\sqrt{x-2} = 5$ is...
- 138 1940_01_IN_07 Radicals: Rationalizing Denominators
The fraction $\frac{1}{\sqrt{3}+1}$ expressed with a rational denominator is...
- 139 1940_01_IN_08 Quadratics: Sum and Product of Roots
The product of the roots of the equation $x^2 + px - 3 = 0$ is...
- 140 1940_01_IN_09 Central Tendency: Averages
The arithmetic mean between 4 and 7 is ...
- 141 1940_01_IN_10 Quadratics: Solving
The positive root of the equation $x^2 - 2x - 3 = 0$ is...
- 142 1940_01_IN_11 Logarithms
The logarithm of 234.3 is ...
- 143 1940_01_IN_12 Logarithms
The number whose logarithm is 1.6518. expressed to the nearest hundredth, is ...

144 1940_01_IN_13 Trigonometry: Finding Sides
In triangle ABC , and $C=90^\circ$, angle $A=35^\circ$, $AB=100$;
the length of BC correct to the *nearest integer* is

145 1940_01_IN_14 Exponents: Operations with
 $a^{2n} \div a = \dots$

146 1940_01_IN_15 Binomial Expansions
The first three terms of the expansion $(a + b)^8$ are
...

150 1940_01_IN_19 Equations: Modeling from a Table
Write the equation which expresses the relation between x and y shown in the table...

X	0	1	2	3...
Y	1	4	7	10...

151 1940_01_IN_20 Equations: Forming Quadratics from Roots
Write in the form $x^2 + px + q = 0$, the equation
whose roots are 2 and -1

152 1940_01_IN_21 Progressions: Geometric
Insert two geometric means between 3 and 192.

153 1940_01_IN_22 Variation: Direct
If y varies directly with x and if $x = 2$ when $y = 8$,
find the value of y when $x = 7$

154 1940_01_IN_23 Parallel and Perpendicular Lines
The graph of the equations $2x + 3y = 12$ and
 $2x + 3y = 6$ are straight lines which (a) coincide, (b)
intersect or (c) are parallel.

155 1940_01_IN_24 Quadratics: Using the Discriminant
If the discriminant of a quadratic equation is -9, the
roots of the equation are (a) real and equal, (b) real
and unequal or (c) imaginary.

156 1940_01_IN_25 Logarithms
The expression $\log \sqrt{a}$ is equal to (a) $2 \log a$, (b)
 $\frac{1}{2} \log a$ or (c) $\log \frac{1}{2} a$.

147 1940_01_IN_16 Exponents: Operations with
The value of $(16)^{-\frac{1}{2}} \times 4(3)^0$ is...

148 1940_01_IN_17 Equations: Literal
The formula $S = \frac{a}{1-r}$ when solved for r is $r = \dots$

149 1940_01_IN_18 Circles: Equations of
Write the equation of the circle whose center is at
the origin and whose radius is 7.

157 1940_01_IN_26 Quadratics: $a > 1$
Find, correct to the *nearest tenth*, the roots of the
equation $2x^2 - 4x - 1 = 0$ [10]

158 1940_01_IN_27 Systems: Other Nonlinear
Solve the following pair of equations, group the
answers, and check *one* set of answers:
 $x^2 + y^2 = 13$ [7,2,1]
 $3x^2 + 2y^2 = 30$

159 1940_01_IN_28 Logarithms
Using logarithms, find, correct to the nearest
hundredth, the value of
a $\sqrt[3]{.1632}$ [6]
b $\frac{\tan 42^\circ}{26.1}$ [4]

160 1940_01_IN_29 Progressions: Geometric
Derive the formula for S , the sum of a geometric
series, in terms of the first term a , the common ratio
 r and the number of terms n . [10]

- 161 1940_01_IN_30 Quadratics: Graphing
 a) Draw the graph of the equation $y = x^2 - 4x$ from $x = -1$ to $x = 5$ inclusive. [6]
 b) Write the equation of the axis of symmetry. [1]
 c) Write the coordinates of the minimum point. [1]
 d) Using the graph made in answer to a, estimate, correct to the nearest tenth, the roots of the equation $x^2 - 4x = 4$ [2]
- 162 1940_01_IN_31 Equations: Roots of Higher Order
 Find the three roots of the equation $x^3 - 2x^2 - x - 6 = 0$ [10]
 * This question is based on one of the optional topics in the syllabus.
- 163 1940_01_IN_32 Systems: Writing Quadratic
 A piece of wire 40 inches long is bent into the form of a right triangle whose hypotenuse is 17 inches. Find the other two sides of the triangle. [6, 4]
- 164 1940_01_IN_33 Systems: Writing
 Write the equations that would be used in solving the following problems. In each case state what the unknown letter or letters represent. (Solution of the equations is not required.)
 a) The sum of the numerator and the denominator of a certain fraction is 14. If the numerator is increased by 3, the resulting fraction exceeds the original fraction by $\frac{3}{8}$. Find the fraction. [5]
 b) An airplane flew a distance of 480 miles in 2 hours when traveling with the wind. Returning against the wind, it was able to travel the same distance in 3 hours. Find the velocity of the wind. [5]
- 165 1940_01_IN_34a Radicals: Simplifying
 Explain why the following statement is in general false:
 $\sqrt{a^2 + b^2} = a + b$ [2]
- 166 1940_01_IN_34b Polynomials: Multiplication and Division of
 Explain why the following statement is in general false:
 $\frac{ac}{a+b} = \frac{c}{b}$ [2]
- 167 1940_01_IN_34c Logarithms
 Explain why the following statement is in general false:
 $\frac{\log a}{\log b} = \log a - \log b$ [2]
- 168 1940_01_IN_34d Numbers: Imaginary
 Explain why the following statement is in general false:
 $\sqrt{-a} = ia$ [2]
- 169 1940_01_IN_34e Exponents: Operations with
 Explain why the following statement is in general false:
 $3^a \times 3^b = 9^{a+b}$ [2]
- 170 1940_01_IN_35 Polygons: Area of
 The perimeter of a parallelogram is 70 feet.
 a) If one side of the parallelogram is represented by y , represent the adjacent side in terms of y . [2]
 b) If the altitudes on two adjacent sides of the parallelogram as bases are in the ratio 3:4, represent these two altitudes in terms of the letter x . [1]
 c) In terms of x and y write two expressions for the area K of the parallelogram. [2]
 If $K = 240$ square feet, find the sides and the altitudes of the parallelogram. [5]
- 171 1940_06_IN_01 Radicals: Rationalizing Denominators
 Express the fraction $\frac{2}{\sqrt{3}}$ with a rational denominator.
- 172 1940_06_IN_02 Radicals: Operations with
 Find the product of $(\sqrt{5} - 2)$ and $(\sqrt{5} + 2)$.
- 173 1940_06_IN_03 Slope Intercept Form of a Line
 Write the slope of the line whose equation is $y = -2x + 3$
- 174 1940_06_IN_04 Numbers: Imaginary
 Express $\sqrt{-16}$ in terms of i .

- 175 1940_06_IN_05 Progressions: Geometric
The formula for the sum S of an infinite geometric series, whose first term is a and whose common ratio r is less than 1, is $S = \dots$
- 176 1940_06_IN_06 Polynomials: Factoring
Factor $3x^2 - 10x + 3$
- 177 1940_06_IN_07 Equations: Literal
Solve for c in the formula $P = \frac{c-d}{a}$
- 178 1940_06_IN_08 Quadratics: Sum and Product of Roots
Write the product of the roots of the equation $2x^2 + px + 3 = 0$
- 179 1940_06_IN_09 Logarithms
Find the logarithm of .06386.
- 180 1940_06_IN_10 Logarithms
Find, correct to the nearest tenth, the number whose logarithm is 2.9358.
- 181 1940_06_IN_11 Trigonometry: Finding Sides
In the triangle ABC , angle $C = 90^\circ$, angle $A = 37^\circ$, and $AC = 10$. Find the length of BC , correct to the nearest tenth.
- 182 1940_06_IN_12 Progressions: Geometric
Insert *two* geometric means between 5 and 135.
- 183 1940_06_IN_13 Equations: Simple with Fractional Expressions
If $x = \frac{4-y}{y}$, does x increase or decrease as y increases from +1 to +4?
- 184 1940_06_IN_14 Progressions: Arithmetic
Find the 15th term of the series 2, 5, 8, ...
- 185 1940_06_IN_15 Radicals: Solving
Solve for x : $\sqrt{2x-3} = 4$
- 186 1940_06_IN_16 Radicals: Operations with
Simplify: $\left(\frac{1}{2a} - \frac{a}{2}\right) \div \left(\frac{1}{a} - 1\right)$
- 187 1940_06_IN_17 Exponents: Operations with
Write the product of a^{3m} and a .
- 188 1940_06_IN_18 Binomial Expansions
Write the first three terms in the expansion of $(x-2)^6$
- 189 1940_06_IN_19 Exponents
Find the value of $4 \times \left(\frac{1}{2}\right)^0 + 2^{-1}$
- 190 1940_06_IN_20 Equations: Modeling from a Table
Write the equation expressing the relation between x and y as shown in the table.
- | | | | | |
|-----|----|---|---|---|
| x | -1 | 1 | 3 | 5 |
| y | 0 | 1 | 2 | 3 |
- 191 1940_06_IN_21 Equations: Forming Quadratics from Roots
Write in the form $x^2 + px = 0$ the equation whose roots are -3 and 0.
- 192 1940_06_IN_22 Quadratics: Using the Discriminant
If the discriminant of a quadratic equation is 17, the roots are (a) real, rational and unequal, (b) real, rational and equal or (c) real, irrational and unequal.
- 193 1940_06_IN_23 Conics
The graph of the equation $xy = 12$ is (a) a circle, (b) an ellipse or (c) a hyperbola.
- 194 1940_06_IN_24 Radicals: Simplifying
The fraction $\frac{4 + \sqrt{8}}{2}$ is equal to (a) $2 + \sqrt{8}$, (b) $2 + \sqrt{2}$ or (c) $3\sqrt{2}$.

- 195 1940_06_IN_25 Logarithms
 Log a^3 is equal to (a) $\log 3a$, (b) $\frac{1}{3} \log a$ or (c) $3 \log a$.
- 196 1940_06_IN_26 Quadratics: Noninteger Solutions
 Find correct to the *nearest tenth*, the roots of the equation $3x^2 - 4x - 5 = 0$ [10]
- 197 1940_06_IN_27 Systems: Quadratic Linear
 Solve the following set of equations, group your answers and check one set:
 $5x^2 - 3xy = 14$ [7,1,2]
 $y = 4x - 7$
- 198 1940_06_IN_28 Trigonometric Functions: Logarithms of
 Using Logarithms Involving Trigonometric Functions, find, correct to the *nearest thousandth*, the value of
 $\sqrt[3]{\frac{3.14 \times \sin 41^\circ}{79.3}}$ [10]
- 199 1940_06_IN_29 Systems: Other Nonlinear
 a) Using the same set of axes, draw the graphs of the equations $x^2 + y^2 = 16$ and $y = x^2$ [3,5]
 b) From the graphs made in answer to a, estimate, correct to the *nearest tenth*, two solutions common to the equations. [2]
- 200 1940_06_IN_30 Quadratics: Completing the Square
 Given the equation $ax^2 + bx + c = 0$; derive the formula for the roots of this equation in terms of a , b and c .
- 201 1940_06_IN_31 Systems: Three Variables
 Solve the following set of equations:
 $2x - 5y + 6z = 11$ [10]
 $3x - 2y + 3z = 9$
 $2x + 4y - 9z = -3$
 * This question is based on one of the optional topics in the syllabus.
- 202 1940_06_IN_32 Systems: Writing Quadratic
 When a certain number consisting of two digits is multiplied by the sum of its digits, the product is 63. If the tens digit is twice the units digit, what is the number? [7, 3]
- 203 1940_06_IN_33a Equations and Expressions: Modeling
 Write the equation that would be used in solving the following problem. State what the unknown letter or letters represent. [Solution of the equation is not required.]
 Find the dimensions of a rectangle if its perimeter is 56 inches and its diagonal is 20 inches. [5]
- 204 1940_06_IN_33b Progressions: Arithmetic
 Write the equation that would be used in solving the following problem. State what the unknown letter or letters represent. [Solution of the equation is not required.]
 Three numbers are in the ratio 2 : 5 : 7. If 7 is subtracted from the second number, the resulting numbers will be in arithmetic progression. Find the three numbers. [5]
- 205 1940_06_IN_34a Radicals: Square Roots
 The following statement is sometimes true and sometimes false. Give one illustration in which it is true and one illustration in which it is false.
 The positive square root of a number is less than the number. [2]
- 206 1940_06_IN_34b Parallel and Perpendicular Lines
 The following statement is sometimes true and sometimes false. Give one illustration in which it is true and one illustration in which it is false.
 The graphs of two equations of the first degree intersect in one point. [2]
- 207 1940_06_IN_34c Circles: Equations of
 The following statement is sometimes true and sometimes false. Give one illustration in which it is true and one illustration in which it is false.
 If a , b and c are each greater than 1, the graph of the equation $ax^2 + by^2 = c$ is a circle. [2]

- 208 1940_06_IN_34d Numbers: Imaginary
The following statement is sometimes true and sometimes false. Give one illustration in which it is true and one illustration in which it is false. A root of a negative number is an imaginary number. [2]
- 209 1940_06_IN_34e Slope
The following statement is sometimes true and sometimes false. Give one illustration in which it is true and one illustration in which it is false. If y is a function of x , y increases as x increases from 0. [2]
- 210 1940_06_IN_35 Rate, Time and Distance
Two points move at different but constant rates along a circle whose circumference is 150 feet. Starting at the same time and from the same point, when they move in opposite directions they coincide every 5 seconds; when they move in the same direction they coincide every 25 seconds. Find their rates in feet per second. [10]
- 211 1940_08_IN_01 Quadratics: Using the Discriminant
If the discriminant of a quadratic equation is -4 , the roots of the equation are (a) rational and equal, (b) rational and unequal, (c) irrational and unequal or (d) imaginary.
- 212 1940_08_IN_02 Conics
The graph of $x^2 + 4y^2 = 25$ is (a) an ellipse, (b) a hyperbola, (c) a parabola or (d) a circle.
- 213 1940_08_IN_03 Progressions: Geometric
Two geometric means between 2 and 128 are (a) 16 and 64, (b) 44 and 86, (c) -8 and 32 or (d) 8 and 32,
- 214 1940_08_IN_04 Logarithms
 $\text{Log } \frac{a^2}{b}$ equals (a) $2 \log a + \log b$, (b) $\frac{1}{2} \log a - \log b$, (c) $2 \log a - \log b$ or (d) $2 \log a + \log b$.
- 215 1940_08_IN_05 Equations: Literal
Using the formula $A = P(1 + rt)$, express r in terms of A , P and t .
- 216 1940_08_IN_06 Radicals: Solving
Solve for x in the equation $\sqrt{6x + 7} - 3 = 0$
- 217 1940_08_IN_07 Radicals: Rationalizing Denominators
Express $\frac{5}{3 + \sqrt{2}}$ as an equivalent fraction with a rational denominator.
- 218 1940_08_IN_08 Radicals: Simplifying
Combine $2\sqrt{18} - \frac{3}{2}\sqrt{2} + \sqrt{\frac{1}{2}}$ into a single term.
- 219 1940_08_IN_09 Equations: Forming Quadratics from Roots
Write the quadratic equation the sum of whose roots is 6 and the product of whose roots is 7.
- 220 1940_08_IN_10 Polynomials: Factoring
Of what binomials are $x^n + 1$ and $x^n - 1$ factors?
- 221 1940_08_IN_11 Progressions: Geometric
Complete the formula $S = \dots$ for a geometric progression in terms of a , r and n .
- 222 1940_08_IN_12 Progressions: Arithmetic
Find the 37th term of the progression $3, 4\frac{1}{2}, 6, \dots$
- 223 1940_08_IN_13 Binomial Expansions
Write the first *three* terms in the expansion of $(a - b)^7$.
- 224 1940_08_IN_14 Equations: Graphing
Find the two values of y corresponding to the given values of x that could be used in plotting the graph of $x + 3y = 5$.
- | | | |
|-----|----|---|
| x | -1 | 5 |
| y | | |
- 225 1940_08_IN_15 Quadratics: Solving
Which, if any, of the sets of x and y values given below are *not* roots of $x^2 - 3x = y$?
- | | | | |
|-----|----|---|---|
| x | -1 | 2 | 3 |
| y | 4 | 2 | 0 |

- 226 1940_08_IN_16 Trigonometry: Finding Sides
At a point 30 feet from the base of a tree the angle of elevation of its top is 53° . Find, correct to the nearest foot, the height of the tree.
- 227 1940_08_IN_17 Logarithms
Find the logarithm of .03306.
- 228 1940_08_IN_18 Logarithms
Find correct to the nearest integer, the number whose logarithm is 3.6593.
- 229 1940_08_IN_19 Variation: Inverse
In the equation $y = 2 - \frac{1}{x}$, does y increase or decrease as x increases from 1?
- 230 1940_08_IN_20 Equations and Expressions: Using Substitution in
Find the value of $x^{\frac{2}{3}} + 3x^2$ when $x = 8$.
- 231 1940_08_IN_21 Fractions: Complex
Simplify $\left(1 - \frac{2}{x^2 + 1}\right) \div (x - 1)$.
- 232 1940_08_IN_22 Equations: Modeling from a Table
Write an equation expressing the relation between x and y shown in the table below:
- | | | | | |
|-----|---|---|---|---|
| x | 1 | 3 | 4 | 5 |
| y | 0 | 4 | 6 | 8 |
- 233 1940_08_IN_23 Equations: Simple
For what value of x do $x + 4$ and $2x - 3$ represent the same number?
- 234 1940_08_IN_24 Points on a Line: Identification of
What is the y intercept of the line represented by the equation $2y = x + 4$?
- 235 1940_08_IN_25 Equations and Expressions: Modeling
A dealer bought radios for \$ A apiece. He sold them at a price that gave him a profit of 40% of the selling price. Using x to represent the selling price, write an equation that expresses the relation between cost, profit, and selling price.
- 236 1940_08_IN_26 Quadratics: Noninteger Solutions
Solve the equation $3x^2 - 2x - 6 = 0$ for values of x correct to the nearest tenth. [10]
- 237 1940_08_IN_27 Systems: Other Nonlinear
Solve the following simultaneous equations and check *one* set of answers:
 $x^2 - 2y = 11$ [8,2]
 $x = y + 4$
- 238 1940_08_IN_28 Logarithms
Find, correct to the nearest thousandth, the value of $\frac{408 \times \sqrt[3]{\tan 16^\circ}}{37.5}$
[Use logarithms.] [10]
- 239 1940_08_IN_29 Equations and Expressions: Modeling
In a certain school system the salary scale for teachers starts at \$1400 and provides for a yearly increase of \$75 for the next five years. Miss A, starting at the minimum salary, plans on making \$1350 cover her entire expenses for each year. How much will she be able to save if she stays five years? [Use formula in solution.] [10]
- 240 1940_08_IN_30 Systems: Other Nonlinear
a Plot the graph of $x = y^2 - 2y$ from $y = -2$ to $y = 4$ inclusive. [6]
b On the same set of axes, plot the graph of $2y = 3x$. [2]
c From the graphs made in answer to *a* and *b*, find the values of x and y common to the two equations. [2]

- 241 1940_08_IN_31 Systems: Writing
Write the equations that would be used in solving the following problems. In each case state what the unknown letter or letters represent. [Solution of the equations is not required.]
a The units digit of a two-digit number is twice the tens digit. If the digits are reversed, the resulting number exceeds the original number by 27. Find the original number. [5]
b How many pounds of coffee worth 16¢ a pound must be mixed with 20 pounds of coffee worth 25¢ a pound to have a mixture worth 18¢ a pound? [5]
- 242 1940_08_IN_32 Rate, Time and Distance
The distance from A to B is 90 miles. An autoist starting from A drives at a uniform rate per hour until he is 15 miles from B , when he slows down to one third of his initial rate. He reaches B 40 minutes later than he had planned. Find his original rate.
- 243 1940_08_IN_33a Equations: Logarithmic
Find the value of x if $\log x = 2 + \log 3$ [3]
- 244 1940_08_IN_33b Circles: Area of
A circular pool is surrounded by a walk of uniform width. The difference in the circumferences of the two circles is 22 feet. Find the width of the walk.
[Use $\pi = \frac{22}{7}$] [7]
- 245 1940_08_IN_34a Equations and Expressions: Modeling
Is each of the lettered items, (a) , (b) , (c) , and (d) , in the following problem necessary for the solution? Explain your answer. [Solution of the problem is not required.]
An open tank having (a) a capacity of 15 gallons contains (b) 10 gallons of a solution of salt and water which is (c) 85% salt. How many gallons of water must be evaporated so that the solution shall be (d) 12% salt?[3]
- 246 1940_08_IN_34b Quadratics: Writing
Three hundred rods of fencing are to be used to inclose the largest possible rectangular yard $ABCD$. The fence on side AB is to be made double height. [7]
(1) If x equals the length in rods of side AB , express in terms of x the length of side AD .
(2) If y equals the area of $ABCD$, express y in terms of x .
(3) Graph the equation written in answer to (2) from $x = 0$ to $x = 100$ inclusive, at intervals of 20.
(4) Estimate from the graph the maximum area that the yard can have.

IN - The Intermediate Algebra Curriculum (1950-1960)

- 247 1950_01_IN_01 Polynomials: Factoring
Factor $2x^2 - 3x - 9$
- 248 1950_01_IN_02 Equations: Roots of Higher Order
Is 2 a root of the equation $2x^3 - 7x - 2 = 0$?
Answer *yes* or *no*.
- 249 1950_01_IN_03 Numbers: Imaginary
In terms of i write $\sqrt{-16}$ in its simplest form.
- 250 1950_01_IN_04 Radicals: Operations with
Express as a single term the sum of $\sqrt{27}$ and $\sqrt{12}$
- 251 1950_01_IN_05 Radicals: Solving
Solve for x the equation $\sqrt{2x} + 2 = 6$
- 252 1950_01_IN_06 Radicals: Rationalizing Denominators
Write $\frac{7}{\sqrt{7}-2}$ as a fraction with a rational denominator.
- 253 1950_01_IN_07 Exponents: Operations with
Find the value of $x^{\frac{3}{2}} - x^0$ if $x = 0$
- 254 1950_01_IN_08 Binomial Expansions
Write in simplest form the first two terms in the expansion of $(x + 2y)^5$.
- 262 1950_01_IN_16 Equations: Modeling from a Table
Write an equation of the straight line which passes through the points whose coordinates are given in the following table:
- | | | | | |
|---|---|---|---|----|
| X | 0 | 1 | 2 | 3 |
| Y | 5 | 7 | 9 | 11 |
- 263 1950_01_IN_17 Slope
Find the slope of the straight line whose equation is $2y = 6x + 5$
- 255 1950_01_IN_09 Equations: Literal
Solve for a the formula $S = \frac{1}{2}n(a + l)$
- 256 1950_01_IN_10 Equations and Expressions: Using Substitution in
Using the formula $T = 2\pi r(r + h)$, find T if $\pi = 3.14$, $r = 10$, and $h = 5$.
- 257 1950_01_IN_11 Radicals: Operations with
Express as a single fraction in its lowest terms
 $\frac{5}{a} - \frac{a-b}{6a^2}$
- 258 1950_01_IN_12 Logarithms
Find the logarithm of 4.827
- 259 1950_01_IN_13 Logarithms
If $\log x = 2.8403$, find x to the *nearest tenth*.
- 260 1950_01_IN_14 Systems: Linear
Solve the following pair of equations for x and y :
 $2x + y = 32$
 $x - 3y = 7$
- 261 1950_01_IN_15 Trigonometry: Finding Sides
At a point 20 feet from the base of a flagpole the angle of elevation of its top is 58° . Find, to the *nearest foot*, the height of the flagpole.
- 264 1950_01_IN_18 Variation: Direct
If x varies directly as y^2 and if $x = 9$ when $y = 2$, find x when $y = 8$

- 265 1950_01_IN_19 Equations and Expressions: Modeling
Paul was r years old m years ago. Express his age b years from now.
- 266 1950_01_IN_20 Progressions: Arithmetic
Find the 13th term of the progression 7, 4, 1...
- 267 1950_01_IN_21 Progressions: Geometric
Find two positive numbers which, when inserted between $\frac{1}{2}$ and 32, form with those numbers a geometric progression.
- 268 1950_01_IN_22 Progressions: Geometric
Find the sum of the infinite geometric progression
 $3, \frac{3}{2}, \frac{3}{4}, \dots$
- 269 1950_01_IN_23 Quadratics: Sum and Product of Roots
The sum of the roots of a quadratic equation is -2 and their product is 5. Write this equation in the form $x^2 + px + q = 0$
- 270 1950_01_IN_24 Quadratics: Using the Discriminant
If the discriminant of a quadratic equation is -49, the roots are (a) imaginary (b) real and unequal (c) real and equal.
- 271 1950_01_IN_25 Conics
The graph of the equation $2x^2 - 2y^2 = 15$ is (a) a circle (b) an ellipse (c) a hyperbola
- 272 1950_01_IN_26 Quadratics: Noninteger Solutions
Find, to the *nearest tenth*, the roots of the equation $2x^2 - 7x + 2 = 0$ [10]
- 273 1950_01_IN_27 Systems: Quadratic Linear
Solve the following system of equations, group your answers and check both sets:
 $y^2 + 4x = 21$ [7, 1, 2]
 $y - 2x + 3 = 0$
- 274 1950_01_IN_28 Trigonometric Functions: Logarithms of
Using logarithms, find, to the *nearest tenth*, the value of $\frac{212\sqrt[3]{.492}}{\sin 40^\circ}$ [10]
- 275 1950_01_IN_29 Systems: Other Nonlinear
a) On the same set of axes draw the graphs of $y = 2x - 1$ and $xy = 8$ [2, 6]
b) From the graphs made in answer to a, estimate, to the *nearest tenth*, the values of x and y common to the two equations. [2]
- 276 1950_01_IN_30 Exponential Functions and Equations
a) If $2^{3x+1} = 4^x$, find x [3]
b) If $2^{3x} = 7$, find x to the *nearest tenth*. [7]
*This question is based on one of the optional topics in the syllabus.
- 277 1950_01_IN_31 Systems: Writing
Write the equations that would be used in solving the following problems. In *each* case state what the letter or letters represent. [Solution of the equations is not required.]
a The sum of the digits of a two-digit number is 9. If the number is divided by the units digit, the result is 21. Find the number. [5]
b A man in a motorboat finds it takes him one hour longer to travel 24 miles upstream than it takes him to return. If the rate of the boat is 10 miles per hour in still water, find the rate of the stream. [5]
- 278 1950_01_IN_32 Quadratics: Writing
A man had a rectangular garden whose dimensions were 20 feet by 30 feet. In order to double the area of the garden he added a border of uniform width around it. How wide was the border? [6, 4]
- 279 1950_01_IN_33 Progressions: Arithmetic
The sum of the 2d and the 9th terms of an arithmetic progression is s , and the sum of the 8th and the 10th terms is t . Find the first term of the progression in terms of s and t . [4, 6]

- 280 1950_01_IN_34 Conversions
Each of the expressions in parts (1) - (5) is equivalent to *two* of the four choices given. Write on your answer paper the numbers (1) through (5) and after *each* indicate the correct choice by writing *two* of the letters *a, b, c* and *d*.
- (1) $(x^2)^{-3}$ equals (a) x^{-6} , (b) $\frac{1}{(x^2)^3}$, (c) x^{-8} ,
(d) $\frac{1}{\sqrt[3]{x^2}}$ [2]
- (2) .000027 equals (a) $\frac{27}{1000000}$, (b) 2.7×10^{-6} ,
(c) $(.003)^3$, (d) 2.7×10^{-5} [2]
- (3) $\frac{1 - \frac{1}{a}}{1 - \frac{1}{a^2}}$ equals (a) $\frac{1}{1 + \frac{1}{a}}$, (b) $\frac{1}{1 - \frac{1}{a}}$, (c)
 $\frac{a}{a+1}$, (d) $\frac{1}{a+1}$ [2]
- (4) $2^x \bullet 4^x$ equals (a) 8^x , (b) 8^{2x} , (c) 2^{3x} , (d) 4^{3x}
[2]
- (5) $\text{Log}10x^2$ equals (a) $2 \log 10x$, (b) $20 \log x$, (c)
 $\log 5x + \log 2x$, (d) $1 + 2 \log x$ [2]
- 283 1950_06_IN_03 Radicals: Rationalizing Denominators
Write the fraction $\frac{1}{\sqrt{3}-1}$ with a rational denominator.
- 284 1950_06_IN_04 Fractions: Complex
Simplify the complex fraction $\frac{\frac{1}{x} + \frac{1}{y}}{\frac{1}{xy}}$
- 285 1950_06_IN_05 Equations and Expressions: Using Substitution
in
Using the formula $A = P(1 + rt)$, find *A* when $P = 500$, $r = .03$ and $t = 15$.
- 286 1950_06_IN_06 Variation: Direct
If *r* varies directly as *s* and if $r = 3$ when $s = 8$, find *r* when $s = 12$.
- 281 1950_06_IN_01 Polynomials: Multiplication and Division of
Reduce to lowest terms: $\frac{x-2}{x^2-4}$
- 282 1950_06_IN_02 Numbers: Imaginary
Express in terms of *i* the sum of $\sqrt{-16}$ and $\sqrt{-9}$
- 287 1950_06_IN_07 Radicals: Solving
Solve for *x* the equation $\sqrt{x+2} = 3$
- 288 1950_06_IN_08 Systems: Linear
Solve the following system of equations for *x* and *y*:
 $y - x = 4$
 $y - 2x = 0$
- 289 1950_06_IN_09 Quadratics: Solving
Find the positive root of the equation
 $2x^2 - 3x - 2 = 0$.

- 290 1950_06_IN_10 Quadratics: Sum and Product of Roots
Find the sum of the roots of the equation
 $x^2 - 3x = k$
- 291 1950_06_IN_11 Quadratics: Sum and Product of Roots
Find the product of the roots of the equation
 $x^2 - 3x = 0$.
- 292 1950_06_IN_12 Equations: Literal
Solve the formula $T = 2\pi r^2 + 2\pi rh$ for h .
- 293 1950_06_IN_13 Logarithms
Find the logarithm of 8.324.
- 294 1950_06_IN_14 Logarithms
Find the number whose logarithm is 9.4356 - 10.
- 295 1950_06_IN_15 Trigonometry: Finding Sides
The hypotenuse of a right triangle is 12 and one of the acute angles is 28° . Find, to the *nearest tenth*, the longer leg of the triangle.
- 296 1950_06_IN_16 Progressions: Arithmetic
The first term of an arithmetic progression is $\frac{5}{2}$ and the sixth term is 20. Find the common difference.
- 297 1950_06_IN_17 Progressions: Geometric
Find the sum of the infinite geometric progression whose first term is 3 and whose common ratio is $\frac{1}{3}$.
- 298 1950_06_IN_18 Binomial Expansions
Write the first *two* terms of the expansion of $(x + y)^5$.
- 299 1950_06_IN_19 Equations: Modeling from a Table
Write the linear equation expressing the relationship between x and y shown in the following table:

x	-1	0	2	6
y	-5	-2	4	16

- 300 1950_06_IN_20 Exponents
Assume that x and y are real and not equal to zero. Indicate whether the following statement is True or False.
The expression $x^2 - y^0$ is equal to $\frac{1}{x^2} - 1$.
- 301 1950_06_IN_21 Radicals: Operations with
Assume that x and y are real and not equal to zero. Indicate whether the following statement is True or False.
The expression $\sqrt{x} + \sqrt{y}$ is equal to $\sqrt{x+y}$
- 302 1950_06_IN_23 Quadratics: Using the Discriminant
The roots of the equation $2x^2 - 8x + 3 = 0$ are (a) equal and rational (b) unequal and rational (c) unequal and irrational
- 303 1950_06_IN_24 Systems: Quadratic Linear
The straight line $y = mx$ and the circle $x^2 + y^2 = 9$, when drawn on the same set of axes, (a) intersect regardless of what value m may have (b) may be tangent (c) may not intersect
- 304 1950_06_IN_25 Logarithms
If $\log r + \log s = \log t$, then
(a) $\log(r+s) = \log t$
(b) $r+s = t$
(c) $rs = t$
- 305 1950_06_IN_26 Quadratics: Noninteger Solutions
Find, to the *nearest tenth*, the roots of the equation $3x^2 - 7x = 2$. [10]
- 306 1950_06_IN_27 Systems: Quadratic Linear
Solve the following system of equations, group your answers and check both sets:
 $x^2 + 4y^2 = 13$ [7, 2, 1]
 $x - 2y = 5$

- 307 1950_06_IN_28 Equations: Logarithmic
Given the formula $T = \pi \sqrt{\frac{1}{mgh}}$. Using logarithms, find T to the *nearest hundredth* when $I = 53,400$, $M = 278$, $g = 980$ and $h = 4.3$. [Use $\pi = 3.14$.] [10]
- 308 1950_06_IN_29 Quadratics: Find Vertex Given Equation
a Draw the graph of $y = x^2 - 2x - 8$ from $x = -3$ to $x = +5$. [7]
b Write the equation of the axis of symmetry. [2]
c Find the minimum value of $x^2 - 2x - 8$. [1]
- 309 1950_06_IN_30 Notes and Interest
In how many years (n) will \$500 amount to \$1000 if interest is compounded annually at 4%? Use the formula $A = P(1 + r)^n$ and give your answer to the *nearest year*. [10]
- 310 1950_06_IN_31 Equations: Higher Order
Find the three roots of the equation $2x^3 - 3x^2 - 11x + 6 = 0$. [10]
*This question is based upon one of the optional topics in the syllabus.
- 311 1950_06_IN_32 Alligation
How many pounds of pure water should be evaporated from 70 pounds of salt water, 4% of which (by weight) is pure salt, to increase it to a 5% solution? [7, 3]
- 312 1950_06_IN_33 Equations and Expressions: Modeling
Write the equations that would be used in solving the following problems. In *each* case state what the letter or letters represent. [Solution of the equations is not required.]
a A man invested \$6000 in two enterprises. At the end of the first year he found that he had gained 6% on one of the sums invested and had lost 4% on the other. His net profit for the year was \$160. How much did he invest at each rate? [5]
b Three numbers are in the ratio 1:2:5. If 3 is subtracted from the first number, the second is left unchanged and 9 is added to the third, these three numbers taken in the same order then form a geometric progression. Find the numbers. [5]
- 313 1950_06_IN_34a Slope Intercept Form of a Line
In the following statement, a , b and c are real numbers. Indicate whether the information given is *too little*, *just enough* or *more than is necessary*, to justify the conclusion.
If the graph of $y = mx + b$ is parallel to a line whose equation is given, then the value of m and the value of b are determined. [2]
- 314 1950_06_IN_34b Circles: Center, Radius and Circumference
In the following statement, a , b and c are real numbers. Indicate whether the information given is *too little*, *just enough* or *more than is necessary*, to justify the conclusion.
If the center of a circle is at the origin and the circle passes through the point (a, b) , then the radius of the circle is $\sqrt{a^2 + b^2}$ [2]
- 315 1950_06_IN_34c Conics
In the following statement, a , b and c are real numbers. Indicate whether the information given is *too little*, *just enough* or *more than is necessary*, to justify the conclusion.
If the graph of $ax^2 + by^2 = c$ is an ellipse, then a , b and c have the same sign. [2]
- 316 1950_06_IN_34d Quadratics: Using the Discriminant
In the following statement, a , b and c are real numbers. Indicate whether the information given is *too little*, *just enough* or *more than is necessary*, to justify the conclusion.
If, in the equation $y = ax^2 + bx + c$, a and c are opposite in sign, then the graph of the equation intersects the x - axis. [2]
- 317 1950_06_IN_34e Conics
In following statement, in which a , b and c are real numbers, indicate whether the information given is *too little*, *just enough* or *more than is necessary*, to justify the conclusion.
If, in the equation $ax^2 - by^2 = c$, a , b and c are positive and a is not equal to b , then the graph of the equation is a hyperbola. [2]

- 318 1950_06_IN_35 Equations and Expressions: Modeling
A group of men agreed to contribute equally toward purchasing a gift which was to cost C dollars. Later n men joined the group, thus causing the individual contribution to be d dollars less. These facts are represented graphically in the accompanying figure.

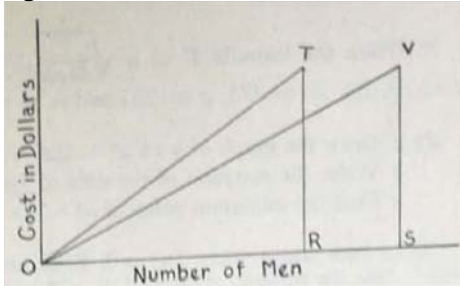

- OR represents the number of men in the group originally, OS the number after n joined the group, and RT (equal to SV) the cost of the gift. Let OR be represented by x .
- Express OS in terms of x and n . [1]
 - Express the slope of line OT in terms of c and x . [2]
 - Express the slope of line OV in terms of c , x and n . [2]
 - Write an equation that would be used to find x in terms of c , d and n . [5]

- 319 1950_08_IN_01 Quadratics: Difference of Perfect Squares
Factor $x^2 - 16$

- 320 1950_08_IN_02 Numbers: Imaginary
Express, in terms of i , one of the roots of the equation $x^2 + 3 = 0$

- 321 1950_08_IN_03 Radicals: Solving
Solve the equation $2\sqrt{x} + 1 = 6$

- 322 1950_08_IN_04 Radicals: Rationalizing Denominators
Write $\frac{1}{3 - \sqrt{2}}$ as a fraction with a rational denominator.

- 323 1950_08_IN_05 Logarithms
Find the logarithm of 0.7352

- 324 1950_08_IN_06 Logarithms
Find the number whose logarithm is 1.7416

- 325 1950_08_IN_07 Fractions: Complex

Simplify the complex fraction $\frac{a + \frac{a}{b}}{1 + \frac{1}{b}}$

- 326 1950_08_IN_08 Rationals: Addition and Subtraction of
Express as a single fraction in its simplest form the sum of $\frac{3}{c-d}$ and $\frac{2}{d-c}$

- 327 1950_08_IN_09 Binomial Expansions
Write the first *three* terms in the expansion of $(x + y)^6$

- 328 1950_08_IN_10 Equations: Modeling from a Table
Write an equation of the straight line which passes through the points whose coordinates are given in the following table:

x	0	2	4	5
y	2	6	10	12

- 329 1950_08_IN_11 Slope Intercept Form of a Line
Find the y-intercept of the straight line whose equation is $y = 2x + 3$

- 330 1950_08_IN_12 Quadratics: Sum and Product of Roots
Find the sum of the roots of the equation $3x^2 - 5x - 21 = 0$

- 331 1950_08_IN_13 Equations: Literal
Solve the formula $T = \pi r(l + r)$ for l .

- 332 1950_08_IN_14 Polynomials: Factoring
One factor of $(x + y)^2 + c(x + y)$ is $(x + y)$. Find the other factor.

- 333 1950_08_IN_15 Exponents
Find the value of $8^{\frac{1}{3}} + 4^0 + 3^{-1}$

- 334 1950_08_IN_16 Variation: Direct
If y varies directly as x and $x = 8$ when $y = 12$, find the value of x when $y = 18$
- 335 1950_08_IN_17 Progressions: Geometric
If 2 and 54 are the first and the fourth terms respectively of a geometric progression, find the ratio.
- 336 1950_08_IN_18 Progressions: Arithmetic
Find the sum of the first 15 terms of the progression -26, -22, -18.....
- 337 1950_08_IN_19 Progressions: Geometric
Find the sum of the infinite geometric progression $2, 1, \frac{1}{2}, \dots$
- 338 1950_08_IN_20 Trigonometry: Finding Sides
A flagpole stands on level ground. The angle of elevation of the top of the flagpole at a point 100 feet from the foot of the pole is 31° . Find, to the nearest foot, the height of the pole.
- 339 1950_08_IN_21 Perimeter
If the perimeter of a rectangle is $4a$ and its length is b , then its width is
(a) $4a - b$ (b) $2a - b$ (c) $\frac{4a}{b}$
- 340 1950_08_IN_22 Exponents: Operations with
The product of $2^a \times 2^b$ is (a) 4^{a+b} (b) 2^{a+b} (c) 2^{ab}
- 341 1950_08_IN_23 Quadratics: Using the Discriminant
If the discriminant of a quadratic equation is 21, then the roots of the equation are (a) real and equal (b) rational and unequal (c) real and unequal
- 342 1950_08_IN_24 Conics
The graph of the equation $10x^2 + y^2 = 100$ is (a) a circle (b) an ellipse (c) a hyperbola
- 343 1950_08_IN_25 Logarithms
If $\log N = k$, then $\log 100N$ equals (a) $2 + k$
(b) $100k$ (c) $2k$
- 344 1950_08_IN_26 Quadratics: Noninteger Solutions
Find, to the nearest tenth, the roots of the equation $2x^2 - 8x - 3 = 0$ [10]
- 345 1950_08_IN_27 Systems: Quadratic Linear
Solve the following system of equations, group your answers and check both sets:
 $x^2 + xy = 12$ [7, 1, 2]
 $2x + y = 7$
- 346 1950_08_IN_28 Solving Logarithm Equations
In the formula $T = \pi \sqrt{\frac{l}{g}}$, $g = 32.2$, $\pi = 3.14$. If $l = 2.16$, find by the use of logarithms the value of T to the nearest hundredth. [10]
- 347 1950_08_IN_29 Systems: Quadratic Linear
a On the same set of axes draw the graphs of $y = x^2 - 3x$ and $x + y = 2$ [6, 2]
b From the graphs made in answer to a, estimate, to the nearest tenth, the values of x and y common to the two equations. [2]
- 348 1950_08_IN_30 Systems: Three Variables
Solve the following system of equations for x , y and z :
 $x + 2y + z = 7$ [10]
 $3x - y + 2z = 11$
 $2x + 3y - 3z = -2$
*This question is based upon one of the optional topics in the syllabus.
- 349 1950_08_IN_31 Equations: Higher Order
Find the roots of the equation:
 $2x^3 + 3x^2 - 11x - 6 = 0$ [10]
*This question is based upon one of the optional topics in the syllabus.

- 350 1950_08_IN_32 Equations and Expressions: Modeling
Write the equations that would be used in solving the following problems. In *each* case state what the letter or letters represent. [Solution of the equations is not required.]
a Flying with the wind, an airplane can travel 480 miles in 2 hours. Returning against the wind, it requires 3 hours to travel the same distance. Find the speed of the plane in calm air. [5]
b A group of boys decided to buy a motor boat that cost \$240. When 2 more boys joined the group it was found that each boy had to pay \$4 less. How many boys were in the original group? [5]
- 351 1950_08_IN_33 Alligation
How much pure alcohol must be added to 3 quarts of a 7% solution of alcohol and water to make it a 28% solution? [10]
- 352 1950_08_IN_34a Quadratics: Axis of Symmetry
For the following statement, indicate whether the information given is *too little*, *just enough*, or *more than is necessary*, to justify the conclusion.
If in the equation $y = x^2 - 4x - c$ the value of c is known, then the axis of symmetry of the graph of $y = x^2 - 4x - c$ can be found. [2]
- 353 1950_08_IN_34b Numbers: Properties of Real
For the following statement, indicate whether the information given is *too little*, *just enough*, or *more than is necessary*, to justify the conclusion.
If $a = 0$ and $b = 0$, then $ab = 0$ [2]
- 354 1950_08_IN_34c Quadratics: Using the Discriminant
For the following statement, indicate whether the information given is *too little*, *just enough*, or *more than is necessary*, to justify the conclusion.
If, in the equation $y = ax^2 + bx + c$, b^2 is less than $4ac$, the graph of the equation does not intersect the x -axis. [2]
- 355 1950_08_IN_34d Radicals: Square Roots
For the following statement, indicate whether the information given is *too little*, *just enough*, or *more than is necessary*, to justify the conclusion.
If a is a real number, then a^2 is greater than a . [2]
- 356 1950_08_IN_34e Slope
For the following statement, indicate whether the information given is *too little*, *just enough*, or *more than is necessary*, to justify the conclusion.
If, in the equation $ax + by = c$, a and b are opposite in sign, then y always increases as x increases. [Consider a , b and c real numbers.] [2]
- 357 1950_08_IN_35 Rate, Time and Distance
Two points A and B are on the sides of a right angle whose vertex is C . $AC = 6$ feet and $BC = 11$ feet. A starts to move away from C at 2 feet per second, and at the same time B starts to move toward C at the same rate of speed.
a How far is A from C at the end of x seconds? [2]
b How far is B from C at the end of x seconds? [2]
c Write an equation expressing the fact that the distance between A and B is 13 feet at the end of x seconds. [4]
d Find the value of x in the equation written in answer to c . [2]
- 358 1960_01_IN_01 Radicals: Rationalizing Denominators
Express $\frac{3}{4 - \sqrt{3}}$ as an equivalent fraction with a rational denominator.
- 359 1960_01_IN_02 Systems: Linear
Solve the following set of equations:
 $2x + 3y = 7$
 $3x - y = -6$
- 360 1960_01_IN_03 Polynomials: Factoring
Factor: $6x^2 - 7x - 10$
- 361 1960_01_IN_04 Exponents
Find the value of $(x + 2)^0 + (x + 1)^{-\frac{2}{3}}$ when $x = 7$.
- 362 1960_01_IN_05 Equations: Literal
Solve the equation $ax + b = bx + c$ for x .
- 363 1960_01_IN_06 Logarithms
Find the logarithm of 0.2247

- 364 1960_01_IN_07 Logarithms
Find the number whose logarithm is 2.8124.
- 365 1960_01_IN_08 Progressions: Arithmetic
Find the 33rd term in the arithmetic progression, 9, 6, 3,
- 366 1960_01_IN_09 Progressions: Geometric
Find two numbers which, when inserted between 24 and 81, from with these numbers a geometric progression.
- 367 1960_01_IN_10 Progressions: Geometric
Find the sum of the infinite geometric progression 9, 6, 4,
- 368 1960_01_IN_11 Rationals: Addition and Subtraction of
Combine into a single fraction $\frac{4}{x-2} - \frac{3}{x}$
- 369 1960_01_IN_12 Variation: Inverse
If b varies inversely as h and if $b = 8$ when $h = 9$, find b when $h = 6$.
- 370 1960_01_IN_13 Equations: Writing Linear
Write an equation of the line which has a slope of 2 and which passes through the point (2, -1).
- 371 1960_01_IN_14 Equations: Modeling from a Table
Write a linear equation which expresses the relationship between x and y shown in the following table:
- | | | | | |
|-----|----|---|---|---|
| x | -1 | 1 | 4 | 8 |
| y | -2 | 4 | 1 | 2 |
| | | | 3 | 5 |
- 372 1960_01_IN_15 Numbers: Imaginary
Express the sum of $\sqrt{-12}$ and $i\sqrt{3}$ as a monomial in terms of i .
- 373 1960_01_IN_16 Scientific Notation
The number 0.0000017 is to be expressed in the form of 1.7×10^n . Find the value of n .

- 374 1960_01_IN_17 Binomial Expansions
Write in simplest form the third term *only* in the expansion of $(x + 2)^7$.
- 375 1960_01_IN_18 Quadratics: Sum and Product of Roots
Find the products of the roots of the equation $3x^2 + 7x - 6 = 0$
- 376 1960_01_IN_19 Radicals: Solving
The value of x which satisfies the equation $\sqrt{x-1} + x = 7$ is
(1) 10 only (2) -10 only (3) both 5 and 10 (4) 5 only
- 377 1960_01_IN_20 Logarithms
If $x = \log m$, then $x + 2$ equals
(1) $\log m^2$ (2) $\log 2m$ (3) $\log 100m$ (4) $\log (m + 2)$
- 378 1960_01_IN_21 Equations: Forming Quadratics from Roots
The roots of the equation $x^2 + px + q = 0$ are -1 and 3. The value of p is
(1) -2 (2) 2 (3) 3 (4) -3
- 379 1960_01_IN_22 Quadratics: Axis of Symmetry
An equation of the axis of symmetry of the graph of the equation $y = 2x^2 + 6x - 5$ is
(1) $x = -\frac{3}{2}$ (2) $x = -3$ (3) $y = -\frac{3}{2}$ (4) $y = -3$
- 380 1960_01_IN_23 Conics
The graph of the equation $4x^2 = 25 + 4y^2$ is
(a) an ellipse (2) a parabola (3) a hyperbola (4) a circle
- 381 1960_01_IN_24 Fractions: Complex
The fraction $\frac{x^{-1}}{x^{-1} + y^{-1}}$ is equal to
(1) y (2) $\frac{y}{x+y}$ (3) $\frac{x+y}{x}$ (4) $\frac{x}{x+y}$

- 382 1960_01_IN_25 Quadratics: Using the Discriminant
The roots of the equation $3x^2 - 7x + 4 = 0$ are
(1) real, rational, equal (2) real, rational, unequal
(3) real, irrational, unequal (4) imaginary
- 383 1960_01_IN_26 Systems: Quadratic Linear
Solve the following system of equations, group
your answers and check them in both equations: [6,
2, 2]
 $x^2 - 3xy = 10$
 $x + y = 1$
- 384 1960_01_IN_27 Systems: Other Nonlinear
a Draw the graph of $y = x^2 - 5x + 4$ from $x =$
 -1 to $x = 6$. [6]
b On the same set of axes used in *a*, draw the
graph of $x^2 + y^2 = 16$. [2]
c From the graphs made in answer to *a* and *b*,
determine the values of x and y common to both
equations. [2]
- 385 1960_01_IN_28 Quadratics: Noninteger Solutions
Find to the *nearest tenth* the roots of $x^2 + 4x + 2 =$
 0 . [10]
- 386 1960_01_IN_29 Trigonometric Functions: Logarithms of
Using logarithms, find to the *nearest tenth* the value
of $\frac{\tan 75^\circ (4.66)^2}{\sqrt[3]{0.941}}$. [10]
- 387 1960_01_IN_30 Exponential Functions and Equations
a Solve for x : $8^{x-2} = 2^{2x}$ [4]
b Solve for x to the *nearest tenth*: $3^{2x} = 50$
[6]
* This question is based on one of the optional
topics in the syllabus.
- 388 1960_01_IN_31 Systems: Three Variables
Solve the following set of equations for x , y and z
and check: [8,2]
 $3x + 2y - 4z = 11$
 $2x - y + 3z = 0$
 $x + 3y - 5z = 8$
* This question is based on one of the optional
topics in the syllabus.
- 389 1960_01_IN_32 Systems: Writing
Write the equation or equations that would be used
to solve the following problems. In *each* case state
what the letter or letters represent. [Solution of the
questions is not required.]
a John can do a job in 10 minutes
less time than William. One day John worked
alone for 15 minutes; then William worked alone
for 20 minutes to finish the job. How long would it
take each working alone to do the job? [5]
b If a two-digit number is divided by
the sum of the digits, the result is 4. If the digits are
reversed, the new number exceeds the original
number by 36. Find the original number. [5]
- 390 1960_01_IN_33 Progressions: Geometric
Three numbers are in the ratio of 1:2:3. If 2 is
added to the smallest number, the resulting number
together with the other two numbers form a
geometric progression. Find the original numbers.
[5,5]
- 391 1960_01_IN_34 Volume
A rectangular piece of cardboard is twice as long as
it is wide. From each of its four corners a square
piece 3 inches on a side is cut out. The flaps are
then turned up to form an open box. If the volume
of the box is 168 cubic inches, find the original
dimensions of the piece of cardboard. [6, 4]
- 392 1960_01_IN_35 Alligation
A chemist wishes to make 30 ounces of 12%
solution of disinfectant. To do this he mixes a 33%
solution of disinfectant with a 10% solution. Find
to the *nearest tenth* the number of ounces of *each*
that he uses. [5, 5]
- 393 1960_06_IN_01 Numbers: Imaginary
Express as a single term the sum of $6i$ and $\sqrt{-9}$.
- 394 1960_06_IN_02 Quadratics: Solving
Find the positive root of the equation $2t^2 + 5t - 33 =$
 0 .

- 395 1960_06_IN_03 Equations: Literal
Solve for t the formula $A = P(1 + rt)$.
- 396 1960_06_IN_04 Radicals: Rationalizing Denominators
Express $\frac{2}{4 - \sqrt{7}}$ as an equivalent fraction with a rational denominator.
- 397 1960_06_IN_05 Binomial Expansions
Write in *simplest form* the second term *only* in the expansion of $(2a + b)^4$.
- 398 1960_06_IN_06 Logarithms
Find $\log 0.6638$.
- 399 1960_06_IN_07 Logarithms
Find N if $\log N = 0.4226$.
- 400 1960_06_IN_08 Trigonometry: Finding Angles
Find to the *nearest degree* the angle of elevation of the sun when a 21-foot vertical pole casts a 30-foot shadow on level ground.
- 401 1960_06_IN_09 Variation: Inverse
If x varies inversely as y and if $x = 12$ when $y = 8$, find x when $y = 10$.
- 402 1960_06_IN_10 Polynomials: Multiplication and Division of
Perform the indicated operations and express the result in *simplest form*:

$$\left(1 + \frac{1}{x}\right)\left(\frac{1}{x+1} - 1\right)$$
- 403 1960_06_IN_11 Progressions: Arithmetic
Find the 57th term of the arithmetic progression 20, 16, 12,
- 404 1960_06_IN_12 Progressions: Geometric
Insert *two* geometric means between 36 and $4\frac{1}{2}$.
- 405 1960_06_IN_13 Exponents
If $x = 4$, find the value of $4x^{\frac{1}{2}} + (x^0 + 3)^{-1}$.
- 406 1960_06_IN_14 Equations: Forming Quadratics from Roots
If the roots of the equation $x^2 + kx + t = 0$ are $3 + \sqrt{2}$ and $3 - \sqrt{2}$, find the value of k .
- 407 1960_06_IN_15 Slope Intercept Form of a Line
Write an equation of the line which passes through the point $(0, -3)$ and which has the same slope as the line whose equation is $y = 2x + 6$.
- 408 1960_06_IN_16 Quadratics: Axis of Symmetry
Write an equation of the axis of symmetry of the graph of the equation

$$y = x^2 - 6x + 5$$
- 409 1960_06_IN_17 Exponential Functions and Equations
Solve for x : $x^{\frac{1}{2}} = 64$
- 410 1960_06_IN_18 Equations: Modeling from a Table
Write a linear equation expressing the relationship between x and y shown in the following table:
- | | | | | |
|-----|----|---|---|---|
| x | -1 | 1 | 3 | 6 |
| y | 2 | 6 | 1 | 1 |
| | | | 0 | 6 |
- 411 1960_06_IN_19 Logarithms
If $\log N^3 = 9.3643 - 10$, find $\log N$
- 412 1960_06_IN_20 Systems: Other Nonlinear
Solve the following set of equations:

$$5x + y = 2$$

$$3x = -y$$
- 413 1960_06_IN_21 Consecutive Integers
If the sum of three consecutive numbers is S , express in terms of S the smallest of these numbers.
- 414 1960_06_IN_22 Progressions: Geometric
Find the sum of the infinite geometric progression

$$2, \frac{2}{3}, \frac{2}{9}, \dots$$

- 415 1960_06_IN_23 Radicals: Solving
The equation $x + \sqrt{x-2} = 2$ has
(1) both 2 and 3 as roots
(2) 2 as its only root
(3) 3 as its only root
(4) neither 2 nor 3 as its roots
- 416 1960_06_IN_24 Logarithms
If $T = 10x^2$, then $\log T$ equals
(1) $1 + 2 \log x$ (2) $1 + 2x$ (3) $10 + 2 \log x$
(4) $20 \log x$
- 417 1960_06_IN_25 Quadratics: Using the Discriminant
If the roots of the equation $2x^2 - 3x + c = 0$ are real and irrational, the value of c may be
(1) 1 (2) 2 (3) 0 (4) -1
- 418 1960_06_IN_26 Numbers: Properties of Real
An illustration of the distributive law is
(1) $ab + ac = ac + ab$
(2) $(a + b) + c = a + (b + c)$
(3) $a(b + c) = ab + ac$
(4) $(ab)c = a(bc)$
- 419 1960_06_IN_28 Systems: Other Nonlinear
The graphs of the equations $x^2 + y^2 = 25$ and $y = x^2$ are drawn on the same set of axes. The total number of points common to the graphs is
(1) one (2) two (3) three (4) four
- 420 1960_06_IN_29 Quadratics: Sum and Product of Roots
Of the equations given below, the one which has the product of its roots equal to 4 is
(1) $2x^2 - 3x + 4 = 0$
(2) $2x^2 - 8x + 5 = 0$
(3) $x^2 - 4 = 0$
(4) $2x^2 - 3x + 8 = 0$
- 421 1960_06_IN_30 Ratio
If t represents the tens digit and u represents the units digit of a two-digit number, the ratio of the number to the number with the digits reversed is
(1) $\frac{tu}{ut}$ (2) $\frac{t+u}{u+t}$ (3) $\frac{10t+u}{10u+t}$ (4) $\frac{10u+t}{10t+u}$
- 422 1960_06_IN_31 Systems: Other Nonlinear
With respect to a certain rectangle and a certain square these facts are known : The sum of their areas is 68; the length of the rectangle is twice its width and a side of the square exceeds the width of the rectangle by 2. Find the dimensions of the rectangle and the length of a side of the square. *Only algebraic solutions will be accepted.* [5, 5]
- 423 1960_06_IN_32 Quadratics: $a > 1$
Find to the *nearest tenth* the roots of the equation $3x^2 + 5x - 4 = 0$. [10]
- 424 1960_06_IN_33 Systems: Quadratic Linear
Solve the following set of equations, group your answers and check in both equations. [7, 1, 2]
 $xy + y^2 = 3$
 $2x + y = 1$
- 425 1960_06_IN_34 Quadratics: Graphing
 a Draw the graph of $y = x^2 + 4x - 5$ for values of x from $x = -6$ to $x = 2$. [6]
 b From the graph made in answer to a , estimate to the *nearest tenth* the positive root of the equation $x^2 + 4x - 5 = -1$ [2]
 c From the graph made in answer to a , find a value of k for which both roots of the equation $x^2 + 4x - 5 = k$ will be negative. [2]

426 1960_06_IN_35 Rate, Time and Distance
 At 9 a.m. Mike started from home on a hike to a town 12 miles away. He took one hour for lunch and then returned home over the same route, arriving home at 5 p.m. If his average rate returning was one mile per hour *less* than his rate going, find his rate on the return trip. *Only algebraic solutions will be accepted.* [5,5]

427 1960_06_IN_36 Equations: Logarithmic
 Given the formula $V = \pi r^2 h$. By means of logarithms, find to the *nearest tenth* the value of r when $V = 5340$ and $h = 14.6$.
 [Use the approximation $\pi = 3.14$]

428 1960_06_IN_37 Systems: Three Variables
 Solve the following set of equations and check:
 [7,3]

$$x + 3y + z = 0$$

$$x + 4z = -2$$

$$-6y + z = 1$$

* This question is based on one of the optional topics in the syllabus.

429 1960_08_IN_01 Radicals: Rationalizing Denominators
 Express $\frac{3}{\sqrt{5} + 1}$ as an equivalent fraction with a rational denominator.

430 1960_08_IN_02 Exponents
 Write in *simplest form* the value of $3x^0 + x^{\frac{2}{3}}$ if $x = 8$.

431 1960_08_IN_03 Logarithms
 Find the logarithm of 29.06.

432 1960_08_IN_04 Logarithms
 Find the number whose logarithm is 8.8472-10.

433 1960_08_IN_05 Binomial Expansions
 Write in *simplest form* the third term in the expansion of $(1 - x)^6$

434 1960_08_IN_06 Quadratics: Solving
 Find the positive root of the equation $2x^2 - 3x - 2 = 0$

435 1960_08_IN_07 Equations: Forming Quadratics from Roots
 If a root of the equation $x^2 - 6x + k = 0$ is 2, find the value of k .

436 1960_08_IN_08 Equations: Modeling from a Table
 Write an equation of the straight line which passes through the points whose coordinates are given in the table below.

x	0	2	5
y	-1	5	14

437 1960_08_IN_09 Points on a Line: Identification of
 Find the coordinates of the point where the graph of the equation $2x + 3y = 12$ intersects the x-axis.

438 1960_08_IN_10 Progressions: Arithmetic
 Find the three numbers which, when inserted between 6 and 12, form with them an arithmetic progression.

439 1960_08_IN_11 Progressions: Geometric
 Express as a fraction the sum of the infinite geometric progression 2, 0.2, 0.02,

440 1960_08_IN_12 Variation: Direct
 If s varies directly as t and if $s = 10$ when $t = 12$, find the value of s when $t = 18$.

441 1960_08_IN_13 Rationals: Solving
 Solve for x : $\frac{1}{a} - \frac{1}{x} = \frac{1}{b}$

442 1960_08_IN_14 Conversions
 Using the formula $C = \frac{5}{9}(F - 32)$, find F if $C = 80$.

- 443 1960_08_IN_15 Scientific Notation
If the number 0.0068 is expressed in the form 6.8×10^n , find the value of n .
- 444 1960_08_IN_16
The base of an isosceles triangle is 24 inches and one of the base angles is 53° . Find to the *nearest inch* the altitude drawn to the base.
- 445 1960_08_IN_17 Quadratics: Axis of Symmetry
What is the abscissa of the turning point of the graph whose equation is $y = x^2 + 6x + 8$?
- 446 1960_08_IN_18 Quadratics: Sum and Product of Roots
Find the sum of the roots of the equation $x^2 + 2x + 5 = 0$.
- 447 1960_08_IN_19 Slope
Find the slope of the line whose equation is $x + 2y = 4$.
- 448 1960_08_IN_20 Central Tendency: Averages
If a man travels y miles in x hours, express his average speed in miles per hour in terms of x and y .
- 449 1960_08_IN_21 Numbers: Imaginary
When expressed in terms of the imaginary unit i , $\sqrt{-3}$ is
(1) $i\sqrt{3}$ (2) $-i\sqrt{3}$ (3) $3i$
(4) $-3i$
- 450 1960_08_IN_22 Fractions: Complex
The expression $\frac{1}{1 + \frac{1}{x}}$ is equivalent to
(1) $\frac{x}{x+1}$ (2) $\frac{x+1}{x}$ (3) x (4) $\frac{1}{x}$
- 451 1960_08_IN_23 Conics
The graph of $2x^2 + 3y^2 = 6$ is
(1) a circle (2) an ellipse (3) a hyperbola (4) a parabola
- 452 1960_08_IN_24 Radicals: Solving
The equation $\sqrt{x} + 5 = 2$ has
(1) an integral root (2) an irrational root (3) an imaginary root (4) no root
- 453 1960_08_IN_25 Quadratics: Using the Discriminant
If the discriminant of the equation $ax^2 + bx + c = 0$ is positive (a , b , and c being integers), then the roots of the equation must be
(1) positive (2) rational (3) equal (4) real
- 454 1960_08_IN_26 Logarithms
 $\text{Log } \frac{10}{x}$ is equal to
(1) $\frac{1}{\log x}$ (2) $1 - \log x$ (3) $\frac{1}{x}$
(4) $1 - x$
- 455 1960_08_IN_27 Equations and Expressions: Modeling
The ten digits of a two digit number is twice the units digit. If the units digit is represented by x , the number can be represented by
(1) $3x$ (2) $12x$ (3) $21x$ (4) $30x$
- 456 1960_08_IN_28 Perimeter
If the length of a side of a square is multiplied by 2,
(1) the perimeter is multiplied by 2 and the area by 4
(2) the perimeter is multiplied by 4 and the area by 2
(3) both the perimeter and area are multiplied by 2
(4) both the perimeter and area are multiplied by 4
- 457 1960_08_IN_29 Quadratics: Difference of Perfect Squares
Indicate whether the following statement is true for
 a all real values of x
 b some, but not all, real values of x ,
 c no real values of x
 $x^2 - 4 = (x + 2)(x - 2)$

- 458 1960_08_IN_30 Numbers: Imaginary
Indicate whether the following statement is true for
a all real values of x
b some, but not all, real values of x ,
c no real values of x
 $x^2 + 4 = 0$

- 459 1960_08_IN_31 Quadratics: $a > 1$
Find to the *nearest tenth* the roots of the equation
 $2x^2 - 9x = 1$. [10]

- 460 1960_08_IN_32 Systems: Other Nonlinear
Solve the following set of equations, group your
answers and check them in both equations: [7, 1, 2]
 $x^2 - 3xy + 8y^2 = 9$
 $x - 2y = 3$

- 461 1960_08_IN_33 Quadratics: Graphing
a Draw the graph of $y = x^2 + 3x - 2$, using all
integral values from $x = -5$ to $x = 2$, inclusive. [6]
b Using the graph made in answer to part *a*,
find to the *nearest tenth* the roots of the equation x^2
 $+ 3x - 2 = 1$. [4]

- 462 1960_08_IN_34 Trigonometric Functions: Logarithms of
A formula for finding the base edge of a regular
square pyramid is given by the equation
$$b = \sqrt[3]{\frac{6V}{\tan A}}$$

Using logarithms, find b to the *nearest tenth* if $V =$
 98.7 and $A = 23^\circ$. [10]

- 463 1960_08_IN_35 Systems: Writing Quadratic
A piece of wire 36 inches long is bent into the form
of a right triangle. If one of the legs is 12 inches
long, find the length of the other leg. [6, 4]

- 464 1960_08_IN_36 Rate, Time and Distance
John left New York for a town in the mountains.
He traveled 60 miles and then returned to New
York over the same route. His average speed
returning was 10 miles per hour more than his
speed going. He spent a total of 5 hours traveling.
What was his average speed in miles per hour on
the return trip? [5,5]

- 465 1960_08_IN_37 Equations: Higher Order
Solve for x : $x^3 + x^2 - 8x - 12 = 0$
[10]

* This question is based on one of the optional
topics in the syllabus.

MA - The Mathematics A Curriculum (2000 - 2009)

- 1 2000_01_MA_01 Radicals: Square Roots

The expression $\sqrt{93}$ is a number between

- 1) 3 and 9
- 2) 8 and 9
- 3) 9 and 10
- 4) 46 and 47

- 2 2000_01_MA_02 Numbers: Comparing Real

Which number has the greatest value?

- 1) $1\frac{2}{3}$
- 2) $\sqrt{2}$
- 3) $\frac{\pi}{2}$
- 4) 1.5

- 3 2000_01_MA_03 Logical Reasoning

Mary says, "The number I am thinking of is divisible by 2 or is divisible by 3." Mary's statement is false if the number she is thinking of is

- 1) 6
- 2) 8
- 3) 11
- 4) 15

- 4 2000_01_MA_04 Polynomials: Factoring

Which expression is a factor of $x^2 + 2x - 15$?

- 1) $(x - 3)$
- 2) $(x + 3)$
- 3) $(x + 15)$
- 4) $(x - 5)$

- 5 2000_01_MA_05 Central Tendency

What was the median high temperature in Middletown during the 7-day period shown in the table below?

Daily High Temperature in Middletown	
Day	Temperature (°F)
Sunday	68
Monday	73
Tuesday	73
Wednesday	75
Thursday	69
Friday	67
Saturday	63

- 1) 69
- 2) 70
- 3) 73
- 4) 75

- 6 2000_01_MA_06 Consecutive Integers

If the number represented by $n - 3$ is an odd integer, which expression represents the next greater odd integer?

- 1) $n - 5$
- 2) $n - 2$
- 3) $n - 1$
- 4) $n + 1$

- 7 2000_01_MA_07 Transformations: Reflections

When the point $(2, -5)$ is reflected in the x -axis, what are the coordinates of its image?

- 1) $(-5, 2)$
- 2) $(-2, 5)$
- 3) $(2, 5)$
- 4) $(5, 2)$

8 2000_01_MA_08 Exponents: Operations with

The expression $(x^2z^3)(xy^2z)$ is equivalent to

- 1) $x^2y^2z^3$
- 2) $x^3y^2z^4$
- 3) $x^3y^3z^4$
- 4) $x^4y^2z^5$

9 2000_01_MA_09 Percent

Twenty-five percent of 88 is the same as what percent of 22?

- 1) $12\frac{1}{2}\%$
- 2) 40%
- 3) 50%
- 4) 100%

10 2000_01_MA_10 Triangle Inequalities

A plot of land is in the shape of rhombus $ABCD$ as shown below.

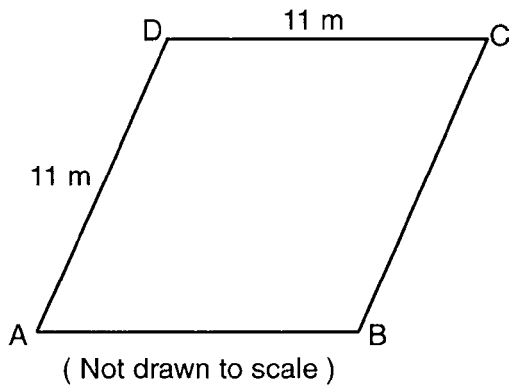

Which can *not* be the length of diagonal AC ?

- 1) 24 m
- 2) 18 m
- 3) 11 m
- 4) 4 m

11 2000_01_MA_11 Equations: Literal

If $9x + 2a = 3a - 4x$, then x equals

- 1) a
- 2) $-a$
- 3) $\frac{5a}{12}$
- 4) $\frac{a}{13}$

12 2000_01_MA_12 Circles: Area of

If the circumference of a circle is 10π inches, what is the area, in square inches, of the circle?

- 1) 10π
- 2) 25π
- 3) 50π
- 4) 100π

13 2000_01_MA_13 Combinatorics: Permutations

How many different 4-letter arrangements can be formed using the letters of the word "JUMP," if each letter is used only once?

- 1) 24
- 2) 16
- 3) 12
- 4) 4

14 2000_01_MA_14 Ratio

Sterling silver is made of an alloy of silver and copper in the ratio of 37:3. If the mass of a sterling silver ingot is 600 grams, how much silver does it contain?

- 1) 48.65 g
- 2) 200 g
- 3) 450 g
- 4) 555 g

15 2000_01_MA_15 Equations and Expressions: Using Substitution in

If $t = -3$, then $3t^2 + 5t + 6$ equals

- 1) -36
- 2) -6
- 3) 6
- 4) 18

16 2000_01_MA_16 Rationals: Addition and Subtraction of

The expression $\frac{y}{x} - \frac{1}{2}$ is equivalent to

- 1) $\frac{2y - x}{2x}$
- 2) $\frac{x - 2y}{2x}$
- 3) $\frac{1 - y}{2x}$
- 4) $\frac{y - 1}{x - 2}$

- 17 2000_01_MA_17 Probability: Experimental
The party registration of the voters in Jonesville is shown in the table below.

Registered Voters in Jonesville	
Party Registration	Number of Voters Registered
Democrat	6,000
Republican	5,300
Independent	3,700

If one of the registered Jonesville voters is selected at random, what is the probability that the person selected is *not* a Democrat?

- 1) 0.333
2) 0.400
3) 0.600
4) 0.667
- 18 2000_01_MA_18 Scientific Notation
If the number of molecules in 1 mole of a substance is 6.02×10^{23} , then the number of molecules in 100 moles is
- 1) 6.02×10^{21}
2) 6.02×10^{22}
3) 6.02×10^{24}
4) 6.02×10^{25}
- 19 2000_01_MA_19 Polynomials: Addition and Subtraction of
When $3a^2 - 2a + 5$ is subtracted from $a^2 + a - 1$, the result is

- 1) $2a^2 - 3a + 6$
2) $-2a^2 + 3a - 6$
3) $2a^2 + 3a - 6$
4) $-2a^2 + 3a + 6$

- 20 2000_01_MA_20 Locus
The distance between parallel lines ℓ and m is 12 units. Point A is on line ℓ . How many points are equidistant from lines ℓ and m and 8 units from point A .

- 1) 1
2) 2
3) 3
4) 4

- 21 2000_01_MA_21 Midpoint
The midpoint M of line segment AB has coordinates $(-3, 4)$. If point A is the origin, $(0, 0)$, what are the coordinates of point B ? [The use of the accompanying grid is optional.]

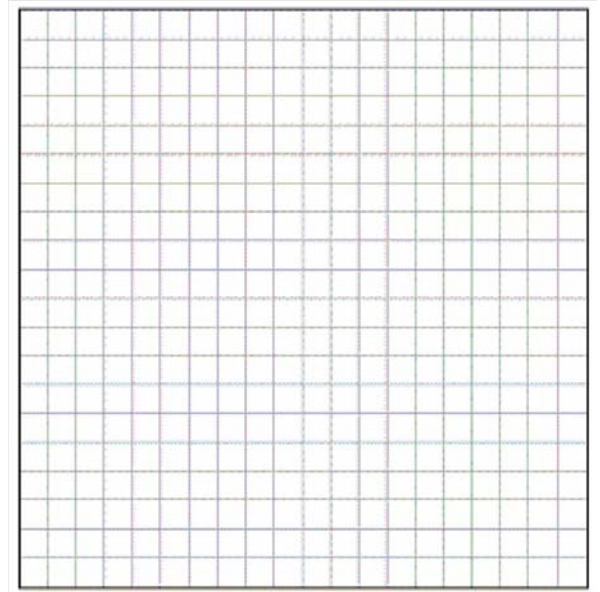

- 22 2000_01_MA_22 Systems: Writing
Mary and Amy had a total of 20 yards of material from which to make costumes. Mary used three times more material to make her costume than Amy used, and 2 yards of material was not used. How many yards of materials did Amy use for her costumer?

- 23 2000_01_MA_23 Triangles: Pythagoras
A wall is supported by a brace 10 feet long, as shown in the diagram below. If one end of the brace is placed 6 feet from the base of the wall, how many feet up the wall does the brace reach?

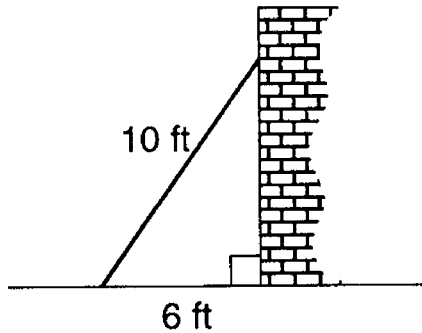

- 24 2000_01_MA_24 Points on a Line: Identification of
A straight line with slope 5 contains the points $(1, 2)$ and $(3, K)$. Find the value of K . [The use of the accompanying grid is optional.]

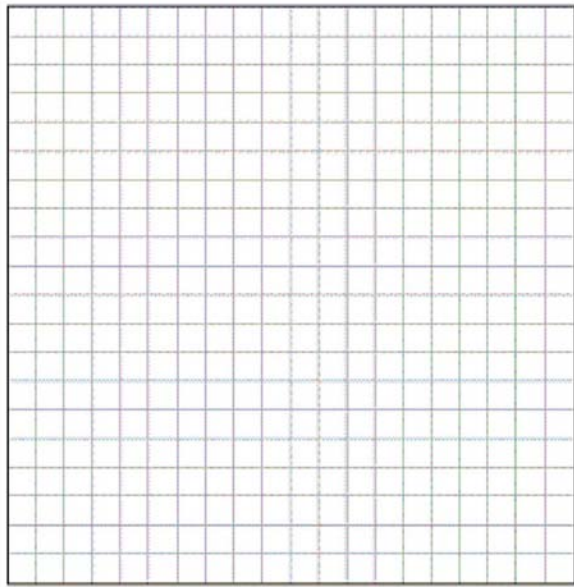

- 25 2000_01_MA_25 Special Quadrilaterals: Parallelograms
Al says, "If $ABCD$ is a parallelogram, then $ABCD$ is a rectangle." Sketch a quadrilateral $ABCD$ that shows that Al's statement is *not* always true. Your sketch must show the length of each side and the measure of each angle for the quadrilateral you draw.

- 26 2000_01_MA_26 Central Tendency: Average Known with Missing Data
Judy needs a mean (average) score of 86 on four tests to earn a midterm grade of B. If the mean of her scores for the first three tests was 83, what is the lowest score on a 100-point scale that she can receive on the fourth test to have a midterm grade of B?

- 27 2000_01_MA_27 Rate, Time and Distance
A truck traveling at a constant rate of 45 miles per hour leaves Albany. One hour later a car traveling at a constant rate of 60 miles per hour also leaves Albany traveling in the same direction on the same highway. How long will it take for the car to catch up to the truck, if both vehicles continue in the same direction on the highway?

- 28 2000_01_MA_28 Polynomials: Multiplication and Division of
In the figure below, the large rectangle, $ABCD$, is divided into four smaller rectangles. The area of rectangle $AEHG = 5x$, the area of rectangle $GHFB = 2x^2$, the area of rectangle $HJCF = 6x$, segment $AG = 5$, and segment $AE = x$.

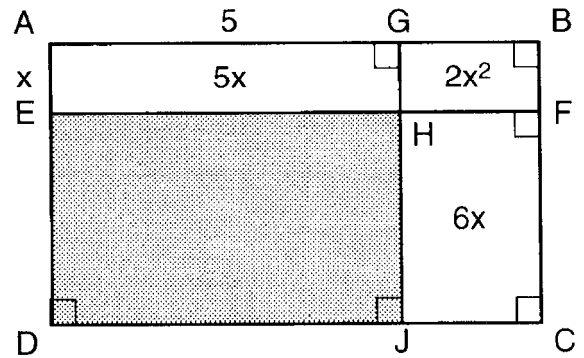

- a Find the area of the shaded region.
b Write an expression for the area of the rectangle $ABCD$ in terms of x .

- 29 2000_01_MA_29 Systems: Other Nonlinear
 a On the set of axes provided below, sketch a circle with a radius of 3 and center at (2, 1) and also sketch the graph of the line $2x + y = 8$.

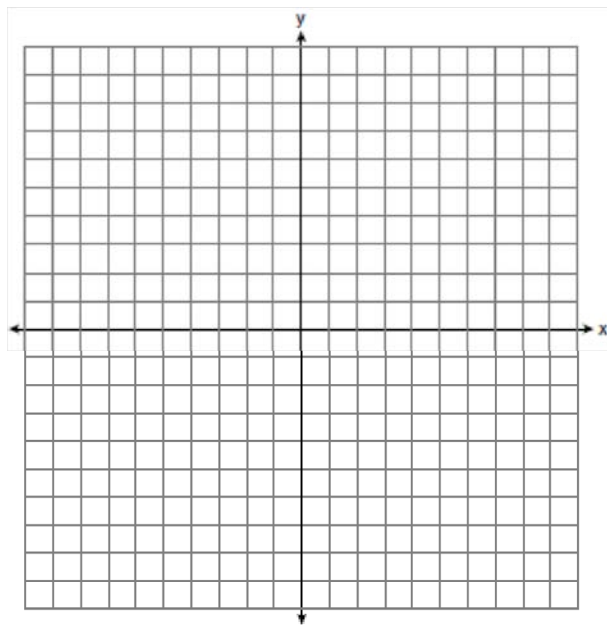

b What is the total number of points of intersection of the two graphs?

- 30 2000_01_MA_30 Volume
 The volume of a rectangular pool is 1,080 cubic meters. Its length, width, and depth are in the ratio 10:4:1. Find the number of meters in each of the three dimensions of the pool.

- 31 2000_01_MA_31 Quadratics: Graphing
 Amy tossed a ball in the air in such a way that the path of the ball was modeled by the equation $y = x^2 + 6x$. In the equation, y represents the height of the ball in feet and x is the time in seconds.
 a Graph $y = x^2 + 6x$ for $0 \leq x \leq 6$ on the grid provided below.

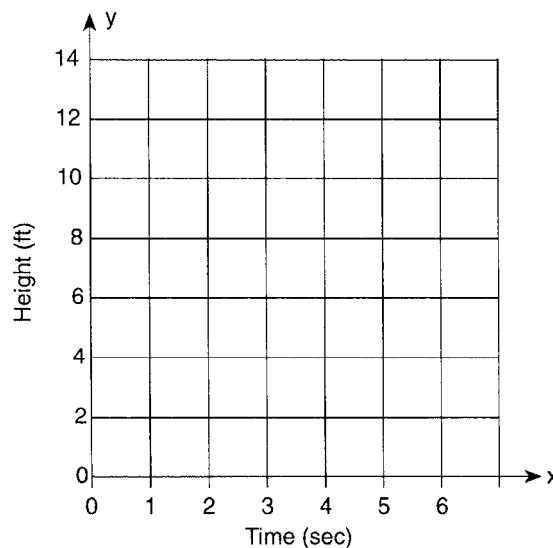

b At what time, x , is the ball at its highest point?

- 32 2000_01_MA_32 Graphic Representations: Histograms and Tables
 In the time trials for the 400-meter run at the state sectionals, the 15 runners recorded the times shown in the table below.

400-Meter Run	
Time (sec)	Frequency
50.0–50.9	
51.0–51.9	
52.0–52.9	
53.0–53.9	
54.0–54.9	

- a Using the data from the frequency column, draw a frequency histogram on the grid provided below.

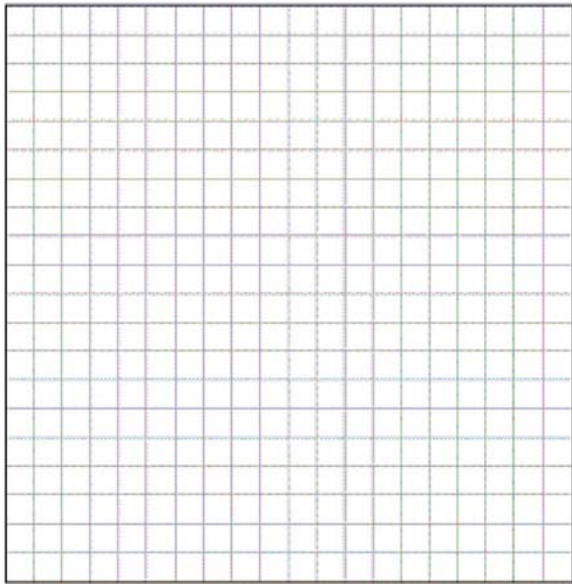

- b What percent of runners completed the time trial between 52.0 and 53.9 seconds?

- 33 2000_01_MA_33 Systems: Writing
 A group of 148 people is spending five days at a summer camp. The cook ordered 12 pounds of food for each adult and 9 pounds of food for each child. A total of 1,410 pounds of food was ordered.
- Write an equation or a system of equations that describes the above situation and define your variables.
 - Using your work from part *a*, find:
 - the total number of adults in the group
 - the total number of children in the group

- 34 2000_01_MA_34 Probability: Theoretical
 Three roses will be selected for a flower vase. The florist has 1 red rose, 1 white rose, 1 yellow rose, 1 orange rose and 1 pink rose from which to choose.
- How many different three rose selections can be formed from the 5 roses?
 - What is the probability that 3 roses selected at random will contain 1 red rose, 1 white rose, and 1 pink rose?
 - What is the probability that 3 roses selected at random will *not* contain an orange rose?

- 35 2000_01_MA_35 Systems: Linear
 The Excel Cable Company has a monthly fee of \$32.00 and an additional charge of \$8.00 for each premium channel. The Best Cable Company has a monthly fee of \$26.00 and an additional charge of \$10.00 for each premium channel. The Horton family is deciding which of these two cable companies to subscribe to.
- For what number of premium channels will the total monthly subscription fee for the Excel and Best Cable companies be the same?
 - The Horton family decides to subscribe to 2 premium channels for a period of one year.
 - Which cable company should they subscribe to in order to spend less money?
 - How much money will the Hortons save in one year by using the less expensive company?

- 36 2000_06_MA_01 Inequalities: Linear
Which inequality is represented in the graph below?

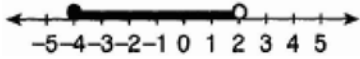

- 1) $-4 < x < 2$
 - 2) $-4 \leq x < 2$
 - 3) $-4 < x \leq 2$
 - 4) $-4 \leq x \leq 2$
- 37 2000_06_MA_02 Symmetry
Which geometric figure has one and only one line of symmetry?

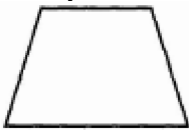

- 1) **Isosceles trapezoid**

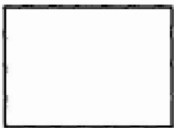

- 2) **Rectangle**



- 3) **Square**

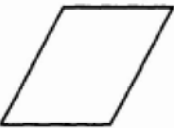

- 4) **Rhombus**

- 38 2000_06_MA_03 Numbers: Properties of Real
Which number is rational?

- 1) π
- 2) $\frac{5}{4}$
- 3) $\sqrt{7}$
- 4) $\sqrt{\frac{3}{2}}$

- 39 2000_06_MA_04 Systems: Writing
Two numbers are in the ratio 2:5. If 6 is subtracted from their sum, the result is 50. What is the larger number?

- 1) 55
- 2) 45
- 3) 40
- 4) 35

- 40 2000_06_MA_05 Exponents

The quotient of $-\frac{15x^8}{5x^2}$, $x \neq 0$, is

- 1) $-3x^4$
- 2) $-10x^4$
- 3) $-3x^6$
- 4) $-10x^6$

- 41 2000_06_MA_06 Logical Reasoning: Inverse

What is the inverse of the statement "If it is sunny, I will play baseball"?

- 1) If I play baseball, then it is sunny.
- 2) If it is not sunny, I will not play baseball.
- 3) If I do not play baseball, then it is not sunny.
- 4) I will play baseball if and only if it is sunny.

- 42 2000_06_MA_07 Systems: Linear

Which ordered pair is the solution of the following system of equations?

$$3x + 2y = 4$$

$$-2x + 2y = 24$$

- 1) (2, -1)
- 2) (2, -5)
- 3) (-4, 8)
- 4) (-4, -8)

- 43 2000_06_MA_08 Circles: Equations of

Which equation represents a circle whose center is (3, -2)?

- 1) $(x + 3)^2 + (y - 2)^2 = 4$
- 2) $(x - 3)^2 + (y + 2)^2 = 4$
- 3) $(x + 2)^2 + (y - 3)^2 = 4$
- 4) $(x - 2)^2 + (y + 3)^2 = 4$

- 44 2000_06_MA_09 Triangles: Pythagoras
The set of integers $\{3, 4, 5\}$ is a Pythagorean triple.
Another such set is
- 1) $\{6, 7, 8\}$
 - 2) $\{6, 8, 12\}$
 - 3) $\{6, 12, 13\}$
 - 4) $\{8, 15, 17\}$

- 45 2000_06_MA_10 Rate, Time and Distance
A truck travels 40 miles from point A to point B in exactly 1 hour. When the truck is halfway between point A and point B , a car starts from point A and travels at 50 miles per hour. How many miles has the car traveled when the truck reaches point B ?
- 1) 25
 - 2) 40
 - 3) 50
 - 4) 60

- 46 2000_06_MA_11 Numbers: Properties of Real
If $a \neq 0$ and the sum of x and $\frac{1}{a}$ is 0, then
- 1) $x = a$
 - 2) $x = -a$
 - 3) $x = -\frac{1}{a}$
 - 4) $x = 1 - a$

- 47 2000_06_MA_12 Slope
The accompanying figure shows the graph of the equation $x = 5$.

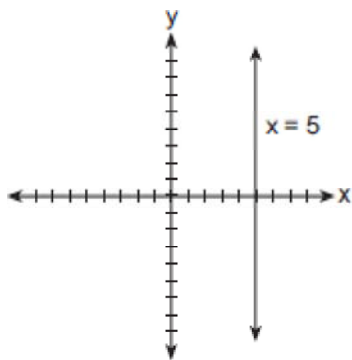

What is the slope of the line $x = 5$?

- 1) 5
- 2) -5
- 3) 0
- 4) undefined

- 48 2000_06_MA_13 Transformations: Isometries
Which transformation does *not* always produce an image that is congruent to the original figure?
- 1) translation
 - 2) dilation
 - 3) rotation
 - 4) reflection

- 49 2000_06_MA_14 Conversions
If rain is falling at the rate of 2 inches per hour, how many inches of rain will fall in x minutes?
- 1) $2x$
 - 2) $\frac{30}{x}$
 - 3) $\frac{60}{x}$
 - 4) $\frac{x}{30}$

- 50 2000_06_MA_15 Polynomials: Multiplication and Division of
The expression $(x - 6)^2$ is equivalent to
- 1) $x^2 - 36$
 - 2) $x^2 + 36$
 - 3) $x^2 - 12x + 36$
 - 4) $x^2 + 12x + 36$

- 51 2000_06_MA_16 Combinatorics: Permutations
How many different five-digit numbers can be formed from the digits 1, 2, 3, 4, and 5 if each digit is used only once?
- 1) 120
 - 2) 60
 - 3) 24
 - 4) 20

- 52 2000_06_MA_17 Central Tendency: Average Known with Missing Data
For five algebra examinations, Maria has an average of 88. What must she score on the sixth test to bring her average up to exactly 90?
- 1) 92
 - 2) 94
 - 3) 98
 - 4) 100

53 2000_06_MA_18 Systems: Quadratic Linear

The graphs of the equations $y = x^2 + 4x - 1$ and $y + 3 = x$ are drawn on the same set of axes. At which point do the graphs intersect?

- 1) (1, 4)
- 2) (1, -2)
- 3) (-2, 1)
- 4) (-2, -5)

54 2000_06_MA_19 Polynomials: Addition and Subtraction of

If $2x^2 - 4x + 6$ is subtracted from $5x^2 + 8x - 2$, the difference is

- 1) $3x^2 + 12x - 8$
- 2) $-3x^2 - 12x + 8$
- 3) $3x^2 + 4x + 4$
- 4) $-3x^2 + 4x + 4$

55 2000_06_MA_20 Exponents

What is the value of 3^{-2} ?

- 1) $\frac{1}{9}$
- 2) $-\frac{1}{9}$
- 3) 9
- 4) -9

56 2000_06_MA_21 Conversions

The formula for changing Celsius (C) temperature to Fahrenheit (F) temperature is $F = \frac{9}{5}C + 32$.

Calculate, to the *nearest degree*, the Fahrenheit temperature when the Celsius temperature is -8.

57 2000_06_MA_22 Constructions

Using only a ruler and compass, construct the bisector of angle BAC in the accompanying diagram.

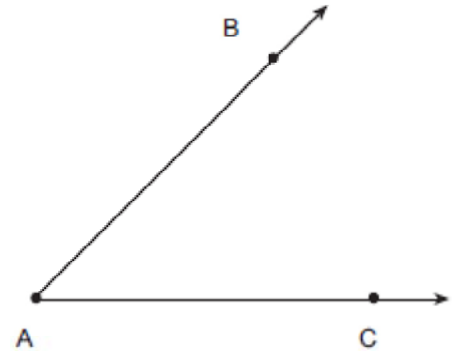

58 2000_06_MA_23 Combinatorics: Permutations

All seven-digit telephone numbers in a town begin with 245. How many telephone numbers may be assigned in the town if the last four digits do *not* begin or end in a zero?

59 2000_06_MA_24 Similarity

The Rivera family bought a new tent for camping. Their old tent had equal sides of 10 feet and a floor width of 15 feet, as shown in the accompanying diagram.

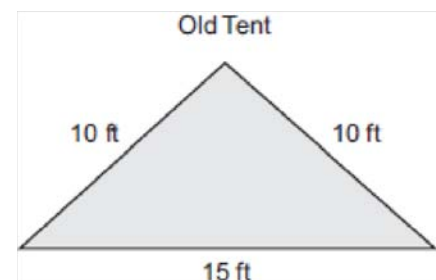

If the new tent is similar in shape to the old tent and has equal sides of 16 feet, how wide is the floor of the new tent?

- 60 2000_06_MA_25 Points on a Line: Identification of
The accompanying graph represents the yearly cost of playing 0 to 5 games of golf at the Shadybrook Golf Course. What is the total cost of joining the club and playing 10 games during the year?

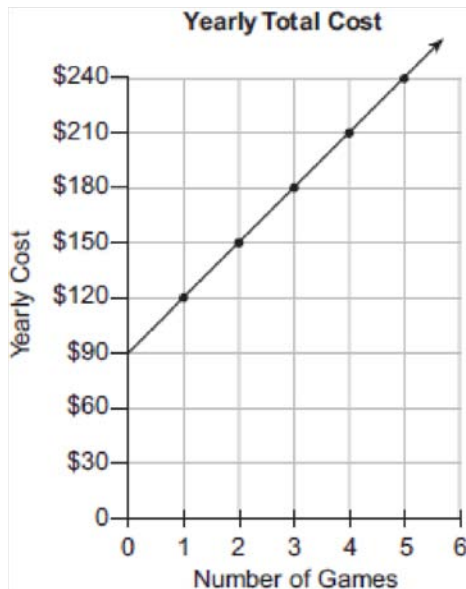

- 61 2000_06_MA_26 Logical Reasoning: Venn Diagrams
The accompanying Venn diagram shows the number of students who take various courses. All students in circle *A* take mathematics. All in circle *B* take science. All in circle *C* take technology. What percentage of the students take mathematics or technology?

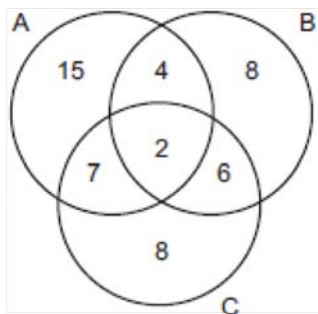

- 62 2000_06_MA_27 Triangles: Isosceles
Hersch says if a triangle is an obtuse triangle, then it cannot also be an isosceles triangle. Using a diagram, show that Hersch is incorrect, and indicate the measures of all the angles and sides to justify your answer.

- 63 2000_06_MA_28 Volume
Tamika has a hard rubber ball whose circumference measures 13 inches. She wants to box it for a gift but can only find cube shaped boxes of sides 3 inches, 4 inches, 5 inches, or 6 inches. What is the *smallest* box that the ball will fit into with the top on?

- 64 2000_06_MA_29 Rate, Time and Distance
The distance from Earth to the imaginary planet Med is 1.7×10^7 miles. If a spaceship is capable of traveling 1,420 miles per hour, how many days will it take the spaceship to reach the planet Med? Round your answer to the *nearest day*.

- 65 2000_06_MA_30 Trigonometry: Finding Sides
A surveyor needs to determine the distance across the pond shown in the accompanying diagram. She determines that the distance from her position to point *P* on the south shore of the pond is 175 meters and the angle from her position to point *X* on the north shore is 32° . Determine the distance, *PX*, across the pond, rounded to the *nearest meter*.

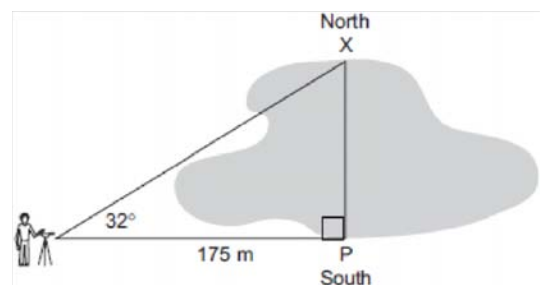

- 66 2000_06_MA_31 Systems: Writing
The owner of a movie theater was counting the money from 1 day's ticket sales. He knew that a total of 150 tickets were sold. Adult tickets cost \$7.50 each and children's tickets cost \$4.75 each. If the total receipts for the day were \$891.25, how many of *each* kind of ticket were sold?

67 2000_06_MA_32 Locus

A treasure map shows a treasure hidden in a park near a tree and a statue. The map indicates that the tree and the statue are 10 feet apart. The treasure is buried 7 feet from the base of the tree and also 5 feet from the base of the statue. How many places are possible locations for the treasure to be buried? Draw a diagram of the treasure map, and indicate with an **X** *each* possible location of the treasure.

68 2000_06_MA_33 Graphic Representation: Histograms and Tables

The scores on a mathematics test were 70, 55, 61, 80, 85, 72, 65, 40, 74, 68, and 84. Complete the accompanying table, and use the table to construct a frequency histogram for these scores.

Score	Tally	Frequency
40–49		
50–59		
60–69		
70–79		
80–89		

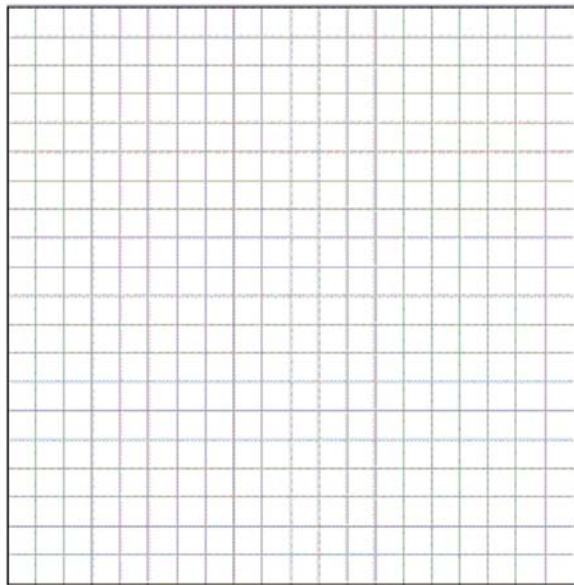

69 2000_06_MA_34 Probability: Theoretical

Paul orders a pizza. Chef Carl randomly chooses two different toppings to put on the pizza from the following: pepperoni, onion, sausage, mushrooms, and anchovies. If Paul will not eat pizza with mushrooms, determine the probability that Paul will *not* eat the pizza Chef Carl has made.

70 2000_06_MA_35 Quadratics: Solving

The area of the rectangular playground enclosure at South School is 500 square meters. The length of the playground is 5 meters longer than the width. Find the dimensions of the playground, in meters. [Only an algebraic solution will be accepted.]

71 2000_08_MA_01 Exponents: Operations with

The product of $2x^3$ and $6x^5$ is

- 1) $10x^8$
- 2) $12x^8$
- 3) $10x^{15}$
- 4) $12x^{15}$

72 2000_08_MA_02 Ratio

A hockey team played n games, losing four of them and winning the rest. The ratio of games won to games lost is

- 1) $\frac{n-4}{4}$
- 2) $\frac{4}{n-4}$
- 3) $\frac{4}{n}$
- 4) $\frac{n}{4}$

73 2000_08_MA_03 Locus

In the coordinate plane, what is the total number of points 5 units from the origin and equidistant from both the x - and y -axes?

- 1) 1
- 2) 2
- 3) 0
- 4) 4

74 2000_08_MA_04 Scientific Notation

Expressed in decimal notation, 4.726×10^{-3} is

- 1) 0.004726
- 2) 0.04726
- 3) 472.6
- 4) 4,726

75 2000_08_MA_05 Variation: Direct

Which table does *not* show an example of direct variation?

1)

<i>x</i>	<i>y</i>
1	4
2	8
3	12
4	16

2)

<i>x</i>	<i>y</i>
2	24
4	12
6	8
8	6

3)

<i>x</i>	<i>y</i>
1	$\frac{1}{2}$
2	1
3	$\frac{3}{2}$
4	2

4)

<i>x</i>	<i>y</i>
-4	-20
-3	-15
-2	-10
-1	-5

76 2000_08_MA_06 Numbers: Comparing Real

If $a < b$, $c < d$, and a , b , c , and d are all greater than 0, which expression is always true?

- 1) $a - c + b - d = 0$
- 2) $a + c > b + d$
- 3) $\frac{a}{d} > \frac{b}{c}$
- 4) $ac < bd$

77 2000_08_MA_07 Volume

The volume of a cube is 64 cubic inches. Its total surface area, in square inches, is

- (1) 16
- (2) 48
- (3) 96
- (4) 576

78 2000_08_MA_08 Central Tendency: Averages

On an English examination, two students received scores of 90, five students received 85, seven students received 75, and one student received 55. The average score on this examination was

- 1) 75
- 2) 76
- 3) 77
- 4) 79

79 2000_08_MA_09 Parallel and Perpendicular Lines

Which equation represents a line parallel to the line $y = 2x - 5$?

- 1) $y = 2x + 5$
- 2) $y = -\frac{1}{2}x - 5$
- 3) $y = 5x - 2$
- 4) $y = -2x - 5$

80 2000_08_MA_10 Numbers: Properties of Real

The operation $*$ for the set $\{p, r, s, v\}$ is defined in the accompanying table. What is the inverse element of r under the operation $*$?

$*$	<i>p</i>	<i>r</i>	<i>s</i>	<i>v</i>
<i>p</i>	<i>s</i>	<i>v</i>	<i>p</i>	<i>r</i>
<i>r</i>	<i>v</i>	<i>p</i>	<i>r</i>	<i>s</i>
<i>s</i>	<i>p</i>	<i>r</i>	<i>s</i>	<i>v</i>
<i>v</i>	<i>r</i>	<i>s</i>	<i>v</i>	<i>p</i>

- 1) *p*
- 2) *r*
- 3) *s*
- 4) *v*

- 81 2000_08_MA_11 Probability: Theoretical
A box contains six black balls and four white balls. What is the probability of selecting a black ball at random from the box?

- 1) $\frac{1}{10}$
- 2) $\frac{6}{10}$
- 3) $\frac{4}{6}$
- 4) $\frac{6}{4}$

- 82 2000_08_MA_12 Quadratics: Solving by Factoring
The solution set for the equation $x^2 - 2x - 15 = 0$ is

- 1) $\{5, 3\}$
- 2) $\{5, -3\}$
- 3) $\{-5, 3\}$
- 4) $\{-5, -3\}$

- 83 2000_08_MA_13 Systems: Linear
What is the value of y in the following system of equations?

$$2x + 3y = 6$$

$$2x + y = -2$$

- 1) 1
- 2) 2
- 3) -3
- 4) 4

- 84 2000_08_MA_14 Logical Reasoning: Converse
What is the converse of the statement "If it is sunny, I will go swimming"?

- 1) If it is not sunny, I will not go swimming.
- 2) If I do not go swimming, then it is not sunny.
- 3) If I go swimming, it is sunny.
- 4) I will go swimming if and only if it is sunny.

- 85 2000_08_MA_15 Equations: Simple
Solve for x : $15x - 3(3x + 4) = 6$

- 1) 1
- 2) $-\frac{1}{2}$
- 3) 3
- 4) $\frac{1}{3}$

- 86 2000_08_MA_16 Radicals: Operations with
The expression $2\sqrt{50} - \sqrt{2}$ is equivalent to

- 1) $2\sqrt{48}$
- 2) 10
- 3) $9\sqrt{2}$
- 4) $49\sqrt{2}$

- 87 2000_08_MA_17 Graphs: Identifying Equations of
Which is an equation of the parabola shown in the accompanying diagram?

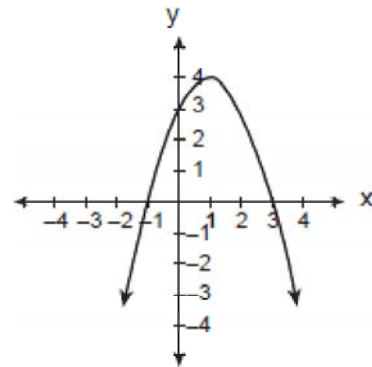

- 1) $y = -x^2 + 2x + 3$
- 2) $y = -x^2 - 2x + 3$
- 3) $y = x^2 + 2x + 3$
- 4) $y = x^2 - 2x + 3$

- 88 2000_08_MA_18 Triangle Inequalities
If two sides of a triangle are 1 and 3, the third side may be

- 1) 5
- 2) 2
- 3) 3
- 4) 4

- 89 2000_08_MA_19 Rate, Time and Distance

A girl can ski down a hill five times as fast as she can climb up the same hill. If she can climb up the hill and ski down in a total of 9 minutes, how many minutes does it take her to climb up the hill?

- 1) 1.8
- 2) 4.5
- 3) 7.2
- 4) 7.5

- 90 2000_08_MA_20 Polynomials: Addition and Subtraction of
When $3x^2 - 2x + 1$ is subtracted from $2x^2 + 7x + 5$, the result will be
- 1) $-x^2 + 9x + 4$
 - 2) $x^2 - 9x - 4$
 - 3) $-x^2 + 5x + 6$
 - 4) $x^2 + 5x + 6$

- 91 2000_08_MA_21 Similarity
The accompanying diagram shows a section of the city of Tacoma. High Road, State Street, and Main Street are parallel and 5 miles apart. Ridge Road is perpendicular to the three parallel streets. The distance between the intersection of Ridge Road and State Street and where the railroad tracks cross State Street is 12 miles. What is the distance between the intersection of Ridge Road and Main Street and where the railroad tracks cross Main Street?

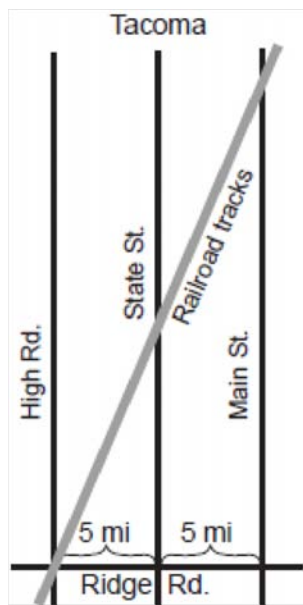

- 92 2000_08_MA_22 Fractions: Complex
Perform the indicated operation and express the result in simplest terms: $\frac{x}{x+3} \div \frac{3x}{x^2-9}$

- 93 2000_08_MA_23 Polygons: Area of
Kerry is planning a rectangular garden that has dimensions of 4 feet by 6 feet. Kerry wants one-half of the garden to have roses, and she says that the rose plot will have dimensions of 2 feet by 3 feet. Is she correct? Explain.
- 94 2000_08_MA_24 Equations and Expressions: Modeling
The sum of the ages of the three Romano brothers is 63. If their ages can be represented as consecutive integers, what is the age of the middle brother?
- 95 2000_08_MA_25 Combinatorics: Combinations
Alan, Becky, Jesus, and Mariah are four students in the chess club. If two of these students will be selected to represent the school at a national convention, how many combinations of two students are possible?
- 96 2000_08_MA_26 Logical Reasoning
John, Dan, Karen, and Beth went to a costume ball. They chose to go as Anthony and Cleopatra, and Romeo and Juliet. John got the costumes for Romeo and Cleopatra, but not his own costume. Dan saw the costumes for Juliet and himself. Karen went as Anthony. Beth drove two of her friends, who were dressed as Anthony and Cleopatra, to the ball. What costume did John wear?
- 97 2000_08_MA_27 Circles: Center, Radius and Circumference
To measure the length of a hiking trail, a worker uses a device with a 2-foot-diameter wheel that counts the number of revolutions the wheel makes. If the device reads 1,100.5 revolutions at the end of the trail, how many miles long is the trail, to the nearest tenth of a mile?

- 98 2000_08_MA_28 Transformations: Compositions of
The coordinates of the endpoints of \overline{AB} are $A(2, 6)$ and $B(4, 2)$. Is the image $\overline{A''B''}$ the same if it is reflected in the x -axis, then dilated by $\frac{1}{2}$ as the image is if it is dilated by $\frac{1}{2}$, then reflected in the x -axis? Justify your answer. (The use of the accompanying grid is optional.)

- 99 2000_08_MA_29 Fraction Madness
 After an ice storm, the following headlines were reported in the *Glacier County Times*:
Monday: Ice Storm Devastates County — 8 out of every 10 homes lose electrical power
Tuesday: Restoration Begins — Power restored to $\frac{1}{2}$ of affected Homes
Wednesday: More Freezing Rain — Power lost by 20% of homes that had power on Tuesday
 Based on these headlines, what fractional portion of homes in Glacier County had electrical power on Wednesday?

- 100 2000_08_MA_30 Distance
 Katrina hikes 5 miles north, 7 miles east, and then 3 miles north again. To the *nearest tenth of a mile*, how far, in a straight line, is Katrina from her starting point?

- 101 2000_08_MA_31 Polygons: Area of
 Mr. Santana wants to carpet exactly half of his rectangular living room. He knows that the perimeter of the room is 96 feet and that the length of the room is 6 feet longer than the width. How many square feet of carpeting does Mr. Santana need?

- 102 2000_08_MA_32 Proofs: Coordinate
 Ashanti is surveying for a new parking lot shaped like a parallelogram. She knows that three of the vertices of parallelogram $ABCD$ are $A(0, 0)$, $B(5, 2)$, and $C(6, 5)$. Find the coordinates of point D and sketch parallelogram $ABCD$ on the accompanying set of axes. Justify mathematically that the figure you have drawn is a parallelogram.

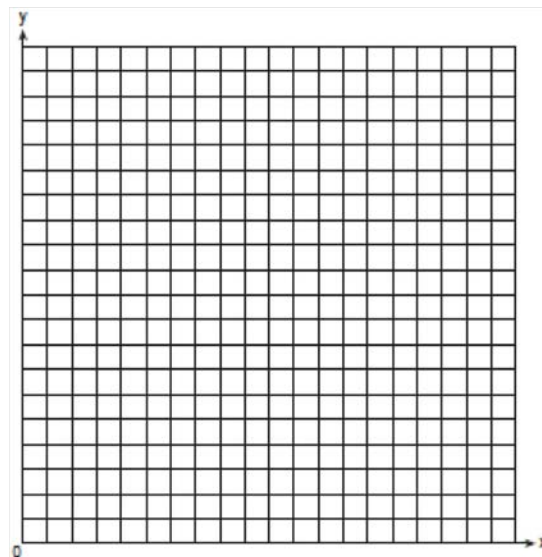

- 103 2000_08_MA_33 Trigonometry: Finding Sides
 A 10-foot ladder is to be placed against the side of a building. The base of the ladder must be placed at an angle of 72° with the level ground for a secure footing. Find, to the *nearest inch*, how far the base of the ladder should be from the side of the building *and* how far up the side of the building the ladder will reach.
- 104 2000_08_MA_34 Combinatorics: Permutations
 The telephone company has run out of seven-digit telephone numbers for an area code. To fix this problem, the telephone company will introduce a new area code. Find the number of new seven-digit telephone numbers that will be generated for the new area code if both of the following conditions must be met:
- The first digit cannot be a zero or a one.
 - The first three digits cannot be the emergency number (911) or the number used for information (411).

- 105 2000_08_MA_35 Quadratics: Solving
Jack is building a rectangular dog pen that he wishes to enclose. The width of the pen is 2 yards less than the length. If the area of the dog pen is 15 square yards, how many yards of fencing would he need to completely enclose the pen?

- 106 2009_01_MA_01 Logical Reasoning
Given the true statements:
"Rob plays basketball or tennis."
"Rob does not play tennis."
Which statement must also be true?
- 1) Rob plays basketball.
 - 2) Rob does not play basketball.
 - 3) Rob does not play basketball, and he does not play tennis.
 - 4) Rob plays football.

- 107 2009_01_MA_02 Variation: Direct
Granola bars cost \$0.55 each. Which table represents this relationship?

1)

Number of Bars	Total Cost
0	\$0.00
2	1.00
4	2.00

2)

Number of Bars	Total Cost
0	\$0.00
2	1.10
4	2.20

3)

Number of Bars	Total Cost
0	\$0.55
2	0.55
4	0.55

4)

Number of Bars	Total Cost
0	\$0.55
2	1.10
4	2.20

- 108 2009_01_MA_03 Equations and Expressions: Modeling
A ship sailed t miles on Tuesday and w miles on Wednesday. Which expression represents the average distance per day traveled by the ship?

- 1) $2(t + w)$
- 2) $t + \frac{w}{2}$
- 3) $\frac{t + w}{2}$
- 4) $t - w$

- 109 2009_01_MA_04 Equations: Simple
What is the value of x in the equation $2(x - 3) + 1 = 19$?

- 1) 6
- 2) 9
- 3) 10.5
- 4) 12

- 110 2009_01_MA_05 Equations: Writing Linear
Which equation represents the line whose slope is 2 and whose y -intercept is 6?

- 1) $y = 2x + 6$
- 2) $y = 6x + 2$
- 3) $2y + 6x = 0$
- 4) $y + 2x = 6$

- 111 2009_01_MA_06 Equations: Simple with Decimals
If $0.02x + 0.7 = 0.8$, then x is equal to

- 1) 0.5
- 2) 2
- 3) 5
- 4) 50

- 112 2009_01_MA_07 Probability: Theoretical
If the probability of a spinner landing on red in a game is $\frac{1}{5}$, what is the probability of it *not* landing on red?

- 1) 20%
- 2) 25%
- 3) 50%
- 4) 80%

- 113 2009_01_MA_08 Equations: Simple
What is the solution for the equation $x + 1 = x + 2$?
- 1) -1
 - 2) $\frac{1}{2}$
 - 3) all real numbers
 - 4) There is no solution.
- 114 2009_01_MA_09 Equations and Expressions: Modeling
If five times the measure of an angle is decreased by 30° , the result is the same as when two times the measure of the angle is increased by 18° . What is the measure of the angle?
- 1) -16°
 - 2) -4°
 - 3) 16°
 - 4) 4°
- 115 2009_01_MA_10 Exponents: Operations with
The expression $(-2a^2b^3)(4ab^5)(6a^3b^2)$ is equivalent to
- 1) $8a^6b^{30}$
 - 2) $48a^5b^{10}$
 - 3) $-48a^6b^{10}$
 - 4) $-48a^5b^{10}$
- 116 2009_01_MA_11 Scientific Notation
What is the value of n if the number 0.0000082 is written in the form 8.2×10^n ?
- 1) -6
 - 2) -5
 - 3) 5
 - 4) 6
- 117 2009_01_MA_12 Radicals: Operations with
The sum of $\sqrt{27}$ and $\sqrt{108}$ is
- 1) $\sqrt{135}$
 - 2) $9\sqrt{3}$
 - 3) $3\sqrt{3}$
 - 4) $4\sqrt{27}$
- 118 2009_01_MA_13 Quadratics: Solving by Factoring
Which equation has the solution set $\{1, 3\}$?
- 1) $x^2 - 4x + 3 = 0$
 - 2) $x^2 - 4x - 3 = 0$
 - 3) $x^2 + 4x + 3 = 0$
 - 4) $x^2 + 4x - 3 = 0$
- 119 2009_01_MA_14 Midpoint
The midpoint of \overline{AB} has coordinates of $(5, -1)$. If the coordinates of A are $(2, -3)$, what are the coordinates of B ?
- 1) $(8, 1)$
 - 2) $(8, -5)$
 - 3) $(7, 0)$
 - 4) $(3.5, -2)$
- 120 2009_01_MA_15 Equations and Expressions: Using Substitution
in
If $x = 2$ and $y = -3$, what is the value of $2x^2 - 3xy - 2y^2$?
- 1) -20
 - 2) -2
 - 3) 8
 - 4) 16

- 121 2009_01_MA_16 Graphic Representation of Data
The accompanying box-and-whisker plots can be used to compare the annual incomes of three professions.

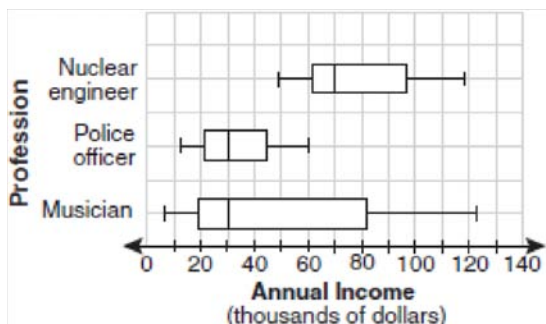

Based on the box-and-whisker plots, which statement is true?

- 1) The median income for nuclear engineers is greater than the income of all musicians.
 - 2) The median income for police officers and musicians is the same.
 - 3) All nuclear engineers earn more than all police officers.
 - 4) A musician will eventually earn more than a police officer.
- 122 2009_01_MA_17 Rationals: Undefined

For which value of m is the expression $\frac{15m^2n}{3-m}$ undefined?

- 1) 1
 - 2) 0
 - 3) 3
 - 4) -3
- 123 2009_01_MA_18 Transformations: Reflections
What is the image of point $(-3, 7)$ after a reflection in the x -axis?
- 1) $(3, 7)$
 - 2) $(-3, -7)$
 - 3) $(3, -7)$
 - 4) $(7, -3)$

- 124 2009_01_MA_19 Special Quadrilaterals: Rectangles and Squares
Which statement is *false*?

- 1) All parallelograms are quadrilaterals.
- 2) All rectangles are parallelograms.
- 3) All squares are rhombuses.
- 4) All rectangles are squares.

- 125 2009_01_MA_20 Systems: Other Nonlinear
The graphs of the equations $x^2 + y^2 = 4$ and $y = x$ are drawn on the same set of axes. What is the total number of points of intersection?

- 1) 1
- 2) 2
- 3) 3
- 4) 0

- 126 2009_01_MA_21 Rationals: Addition and Subtraction of
Expressed as a single fraction, $\frac{3}{4x} - \frac{2}{5x}$ is equal to

- 1) $-\frac{1}{x}$
- 2) $\frac{1}{9x}$
- 3) $\frac{1}{20x}$
- 4) $\frac{7}{20x}$

- 127 2009_01_MA_22 Inequalities: Graphing Systems of
Which point is a solution for the system of
inequalities shown on the accompanying graph?

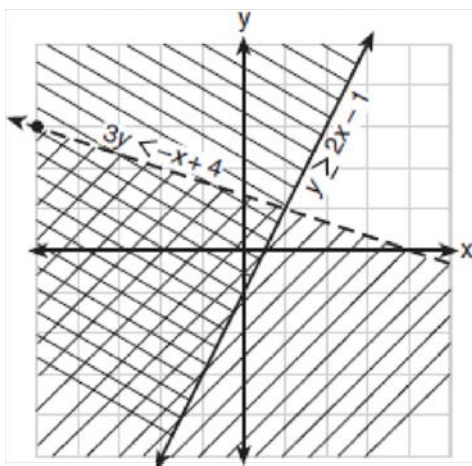

- 1) $(-4, -1)$
2) $(2, 3)$
3) $(1, 1)$
4) $(-2, 2)$
- 128 2009_01_MA_23 Logical Reasoning: Biconditional
Which statement is an example of a biconditional
statement?
1) If Craig has money, he buys a car.
2) Craig buys a car if and only if he has money.
3) Craig has money or he buys a car.
4) Craig has money and he buys a car.
- 129 2009_01_MA_24 Numbers: Properties of Real
Which property of real numbers is illustrated by the
equation $52 + (27 + 36) = (52 + 27) + 36$?
1) commutative property
2) associative property
3) distributive property
4) identity property of addition
- 130 2009_01_MA_25 Combinatorics: Permutations
How many different two-letter arrangements can be
formed using the letters in the word "BROWN"?
1) 10
2) 12
3) 20
4) 25

- 131 2009_01_MA_26 Using Trigonometry to Find a Side
In the accompanying diagram of right triangle ABC ,
 $BC = 12$ and $m\angle C = 40^\circ$.

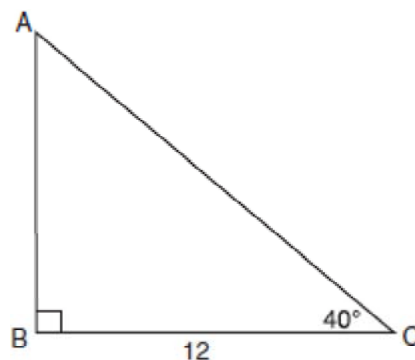

- Which single function could be used to find AB ?
1) $\tan 50$
2) $\sin 50$
3) $\cos 40$
4) $\sin 40$
- 132 2009_01_MA_27 Rationals: Solving
When 5 is divided by a number, the result is 3 more
than 7 divided by twice the number. What is the
number?
1) 1
2) 2
3) $\frac{1}{2}$
4) 5
- 133 2009_01_MA_28 Numbers: Properties of Real
Under which operation is the set of odd integers
closed?
1) addition
2) subtraction
3) multiplication
4) division
- 134 2009_01_MA_29 Combinatorics: Combinations
A basketball squad has ten players. Which
expression represents the number of five-player
teams that can be made if John, the team captain,
must be on every team?
1) ${}_{10}C_5$
2) ${}_9C_4$
3) ${}_9P_4$
4) ${}_{10}P_5$

- 135 2009_01_MA_30 Logical Reasoning: Contrapositive
Which statement is logically equivalent to "If I am in a mathematics class, then I am having fun"?
- 1) If I am not in a mathematics class, then I am not having fun.
 - 2) If I am having fun, then I am in a mathematics class.
 - 3) If I am not having fun, then I am not in a mathematics class.
 - 4) If I am in a mathematics class, then I am not having fun.

- 136 2009_01_MA_31 Similarity
In the accompanying diagram, $\triangle QRS$ is similar to $\triangle LMN$, $RQ = 30$, $QS = 21$, $SR = 27$, and $LN = 7$.
What is the length of ML ?

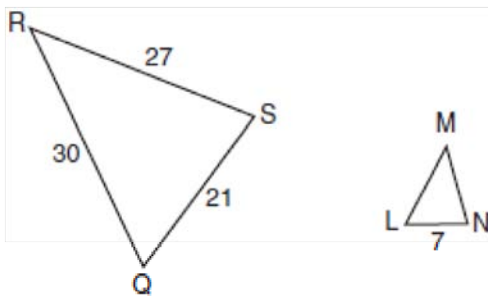

- 137 2009_01_MA_32 Complementary, Supplementary and Vertical Angles
The support beams on a bridge intersect in the pattern shown in the accompanying diagram. If \overline{AB} and \overline{CD} intersect at point E , $m\angle AED = 3x + 30$, and $m\angle CEB = 7x - 10$, find the value of x .

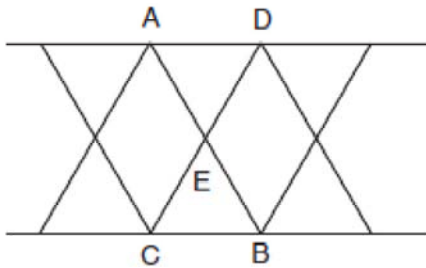

- 138 2009_01_MA_33 Triangles: Pythagoras
The "Little People" day care center has a rectangular, fenced play area behind its building. The play area is 30 meters long and 20 meters wide. Find, to the nearest meter, the length of a pathway that runs along the diagonal of the play area.

- 139 2009_01_MA_34 Polynomials: Addition and Subtraction of
Subtract $2x^2 - 5x + 8$ from $6x^2 + 3x - 2$ and express the answer as a trinomial.

- 140 2009_01_MA_35 Fractions: Complex
Express in simplest form: $\frac{8x}{x^2 - 16} \div \frac{2x}{x + 4}$

- 141 2009_01_MA_36 Central Tendency: Average Known with Missing Data
Juan received scores of 82, 76, 93, and 80 on his first four chemistry tests of the year. His goal is to have an 86 average in chemistry for his first five tests. What score must he earn on the next test to achieve an average of exactly 86?

- 142 2009_01_MA_37 Transformations: Dilations
On the accompanying grid, graph and label quadrilateral $ABCD$, whose coordinates are $A(-1, 3)$, $B(2, 0)$, $C(2, -1)$, and $D(-3, -1)$. Graph, label, and state the coordinates of $A'B'C'D'$, the image of $ABCD$ under a dilation of 2, where the center of dilation is the origin.

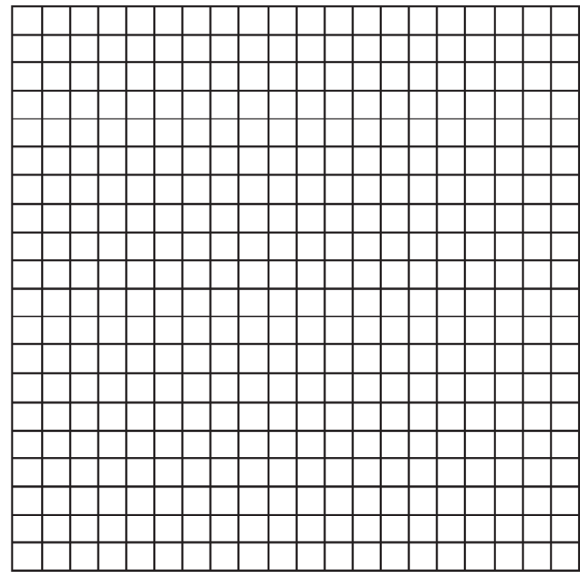

- 143 2009_01_MA_38 Systems: Writing
Mr. Braun has \$75.00 to spend on pizzas and soda pop for a picnic. Pizzas cost \$9.00 each and the drinks cost \$0.75 each. Five times as many drinks as pizzas are needed. What is the maximum number of pizzas that Mr. Braun can buy?

The daily high temperatures for the month of February in New York City were: 34°, 37°, 31°, 36°, 30°, 32°, 32°, 34°, 30°, 37°, 31°, 30°, 30°, 31°, 36°, 34°, 36°, 32°, 32°, 30°, 37°, 31°, 36°, 32°, 31°, 36°, 31°, and 35°.

Complete the table below. Use the table to construct a frequency histogram for these temperatures on the accompanying grid.

Temperature, in Degrees	Tally	Frequency
30		
31		
32		
33		
34		
35		
36		
37		



MB - The Mathematics B Curriculum (2009)

- 1 2009_01_MB_01 Transformations: Reflections
The parabola shown in the accompanying diagram undergoes a reflection in the y -axis.

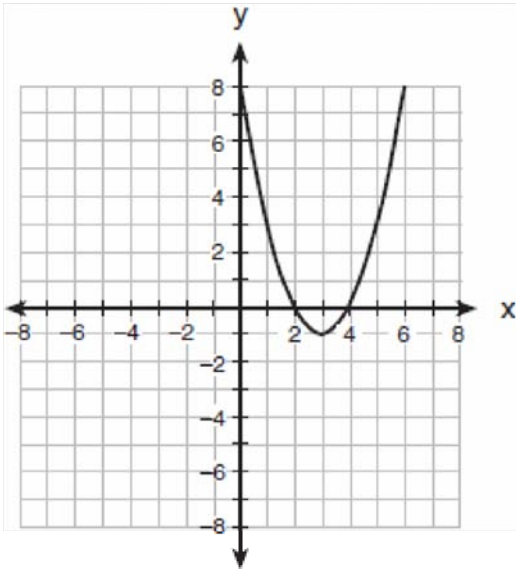

What will be the coordinates of the turning point after the reflection?

- 1) $(3, -1)$
 - 2) $(3, 1)$
 - 3) $(-3, 1)$
 - 4) $(-3, -1)$
- 2 2009_01_MB_02 Radicals: Rationalizing Denominators
The expression $\frac{5}{3 + \sqrt{2}}$ is equivalent to

- 1) $\frac{\sqrt{2} - 15}{3}$
- 2) $\frac{5\sqrt{2} - 15}{5}$
- 3) $\frac{15 - 5\sqrt{2}}{7}$
- 4) $15 - 5\sqrt{2}$

- 3 2009_01_MB_03 Probability: Binomial with "Exactly"
If the probability that the Islanders will beat the Rangers in a game is $\frac{2}{5}$, which expression represents the probability that the Islanders will win *exactly* four out of seven games in a series against the Rangers?

- 1) $\left(\frac{2}{5}\right)^4 \left(\frac{3}{5}\right)^3$
- 2) ${}_5C_2 \left(\frac{4}{7}\right)^2 \left(\frac{3}{7}\right)^3$
- 3) ${}_7C_4 \left(\frac{2}{5}\right)^4 \left(\frac{2}{5}\right)^3$
- 4) ${}_7C_4 \left(\frac{2}{5}\right)^4 \left(\frac{3}{5}\right)^3$

- 4 2009_01_MB_04 Quadratics: Inequalities
What is the solution of the inequality

- $$x^2 - x - 6 < 0?$$
- 1) $-3 < x < -2$
 - 2) $-2 < x < 3$
 - 3) $1 < x < 6$
 - 4) $-3 < x < 2$

- 5 2009_01_MB_05 Numbers: Imaginary
Which expression is equivalent to i^{55} ?

- 1) 1
- 2) -1
- 3) i
- 4) $-i$

- 6 2009_01_MB_06 Transformations: Translations
What is the translation that maps the function $f(x) = x^2 - 1$ onto the function $g(x) = x^2 + 1$?

- 1) $T_{0,2}$
- 2) $T_{0,1}$
- 3) $T_{1,-1}$
- 4) $T_{-1,1}$

- 7 2009_01_MB_07 Quadratics: Find Vertex Given Equation
The height of a swimmer's dive off a 10-foot platform into a diving pool is modeled by the equation $y = 2x^2 - 12x + 10$, where x represents the number of seconds since the swimmer left the diving board and y represents the number of feet above or below the water's surface. What is the farthest depth below the water's surface that the swimmer will reach?
- 1) 6 feet
 - 2) 8 feet
 - 3) 10 feet
 - 4) 12 feet

- 8 2009_01_MB_08 Circles: Chords
The accompanying diagram shows two intersecting paths within a circular garden.

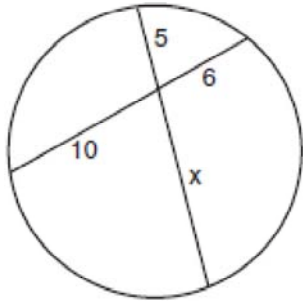

What is the length of the portion of the path marked x ?

- 1) $8\frac{1}{3}$
 - 2) 11
 - 3) 3
 - 4) 12
- 9 2009_01_MB_09 Functions: Compositions of
If $f(x) = 3x - 5$ and $g(x) = x - 9$, which expression is equivalent to $(f \circ g)(x)$?
- 1) $4x - 14$
 - 2) $3x - 14$
 - 3) $3x - 32$
 - 4) $3x^2 - 32x + 45$

- 10 2009_01_MB_10 Circles: Center, Radius and Circumference
A central angle of a circular garden measures 2.5 radians and intercepts an arc of 20 feet. What is the radius of the garden?
- 1) 8 ft
 - 2) 50 ft
 - 3) 100 ft
 - 4) 125 ft

- 11 2009_01_MB_11 Trigonometric Functions: Inverses of

What is a value of $\text{Arc sin}\left(-\frac{\sqrt{2}}{2}\right)$?

- 1) $\frac{\pi}{4}$
 - 2) $-\frac{\pi}{4}$
 - 3) $\frac{\pi}{2}$
 - 4) $-\frac{\pi}{2}$
- 12 2009_01_MB_12 Circles: Equations of
A graphic designer is drawing a pattern of four concentric circles on the coordinate plane. The center of the circles is located at $(-2, 1)$. The smallest circle has a radius of 1 unit. If the radius of each of the circles is one unit greater than the largest circle within it, what would be the equation of the fourth circle?
- 1) $(x - 2)^2 + (y + 1)^2 = 4$
 - 2) $(x + 2)^2 + (y - 1)^2 = 4$
 - 3) $(x - 2)^2 + (y + 1)^2 = 16$
 - 4) $(x + 2)^2 + (y - 1)^2 = 16$
- 13 2009_01_MB_13 Variation: Inverse
Carol notices that the number of customers who visit her coffee shop varies inversely with the average daily temperature. Yesterday, the average temperature was 40° and she had 160 customers. If today's average temperature is 25° , how many customers should she expect?
- 1) 100
 - 2) 145
 - 3) 256
 - 4) 1,000

14 2009_01_MB_14 Functions: Inverses of
 Given the relation $A: \{(3, 2), (5, 3), (6, 2), (7, 4)\}$
 Which statement is true?

- 1) Both A and A^{-1} are functions.
- 2) Neither A nor A^{-1} is a function.
- 3) Only A is a function.
- 4) Only A^{-1} is a function.

15 2009_01_MB_15 Trigonometric Identities
 The expression $\cot \theta \cdot \sec \theta$ is equivalent to

- 1) $\frac{\cos \theta}{\sin^2 \theta}$
- 2) $\frac{\sin \theta}{\cos^2 \theta}$
- 3) $\csc \theta$
- 4) $\sin \theta$

16 2009_01_MB_16 Numbers: Complex
 If $z_1 = -3 + 2i$ and $z_2 = 4 - 3i$, in which quadrant
 does the graph of $(z_2 - z_1)$ lie?

- 1) I
- 2) II
- 3) III
- 4) IV

17 2009_01_MB_17 Conics
 Which graph represents the equation
 $9x^2 = 36 - 4y^2$?

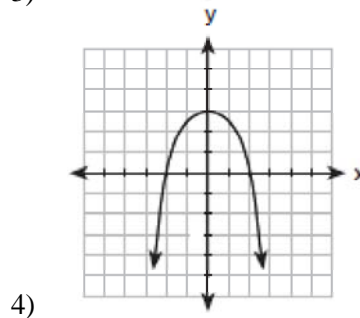
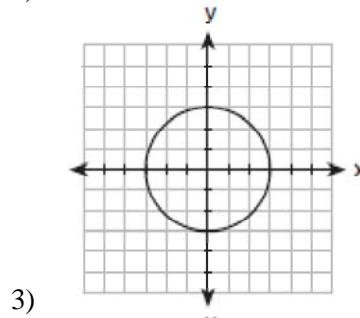
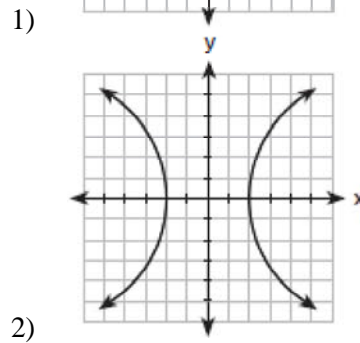
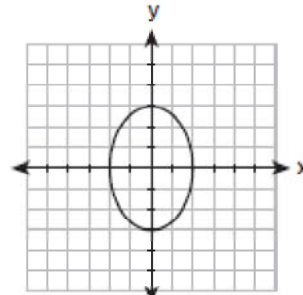

18 2009_01_MB_18 Functions: Domain and Range

The accompanying graph illustrates the presence of a certain strain of bacteria at various pH levels.

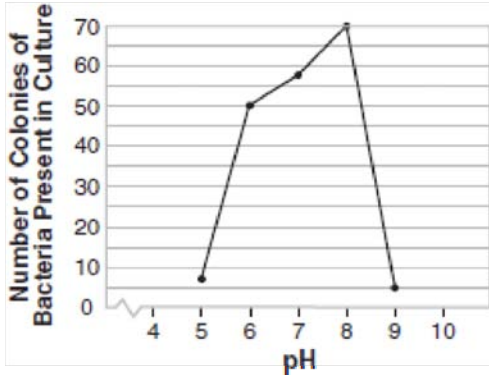

What is the range of this set of data?

- 1) $5 \leq x \leq 9$
- 2) $5 \leq x \leq 70$
- 3) $0 \leq y \leq 70$
- 4) $5 \leq y \leq 70$

19 2009_01_MB_19 Quadratics: Sum and Product of Roots

Juan has been told to write a quadratic equation where the sum of the roots is equal to -3 and the product of the roots is equal to -9 . Which equation meets these requirements?

- 1) $x^2 + 3x + 9 = 0$
- 2) $x^2 - 12x + 27 = 0$
- 3) $2x^2 + 6x - 18 = 0$
- 4) $(x + 3)(x + 9) = 0$

20 2009_01_MB_20 Triangles: Mean Proportionals

The accompanying diagram shows part of the architectural plans for a structural support of a building. $PLAN$ is a rectangle and $\overline{AS} \perp \overline{LN}$.

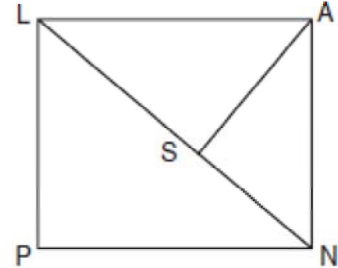

Which equation can be used to find the length of AS ?

- 1) $\frac{LS}{AS} = \frac{AS}{SN}$
- 2) $\frac{AN}{LN} = \frac{AS}{LS}$
- 3) $\frac{AS}{SN} = \frac{AS}{LS}$
- 4) $\frac{AS}{LS} = \frac{LS}{SN}$

21 2009_01_MB_21 Radicals: Solving

Solve for x : $\sqrt{x + 18} - 2 = 2$

22 2009_01_MB_22 Summations

Evaluate: $\sum_{n=1}^3 \left(\sin \frac{n\pi}{2} \right)$

23 2009_01_MB_23 Exponential Growth

Given a starting population of 100 bacteria, the formula $b = 100(2^t)$ can be used to find the number of bacteria, b , after t periods of time. If each period is 15 minutes long, how many minutes will it take for the population of bacteria to reach 51,200?

- 24 2009_01_MB_24 Trigonometry: Finding Area
In the accompanying diagram of parallelogram $ABCD$, $m\angle A = 30^\circ$, $AB = 10$, and $AD = 6$. What is the area of parallelogram $ABCD$?

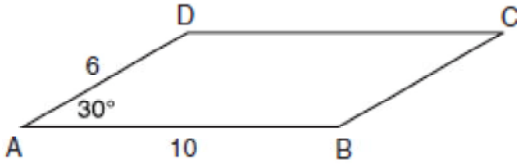

- 25 2009_01_MB_25 Inequalities: Absolute Value
What is the solution of the inequality $|2x - 5| \leq 11$?

- 26 2009_01_MB_26 Equations: Literal
The volume of Earth can be calculated by using the formula $V = \frac{4}{3}\pi r^3$. Solve for r in terms of V .

- 27 2009_01_MB_27 Central Tendency: Dispersion
The average monthly high temperatures, in degrees Fahrenheit, for Binghamton, New York, are given below.

January	28	July	78
February	31	August	76
March	41	September	68
April	53	October	57
May	68	November	44
June	73	December	33

For these temperatures, find, to the *nearest tenth*, the mean, the population standard deviation, and the number of months that fall within one standard deviation of the mean.

- 28 2009_01_MB_28 Fractions: Complex
Perform the indicated operations and express in simplest form: $\frac{3x^2 + 12x - 15}{x^2 + 2x - 15} \div \frac{3x^2 - 3x}{3x - x^2}$

- 29 2009_01_MB_29 Trigonometry: Law of Cosines
In $\triangle ABC$, $a = 24$, $b = 36$, and $c = 30$. Find $m\angle A$ to the *nearest tenth of a degree*.

- 30 2009_01_MB_30 Transformations: Compositions of
Farmington, New York, has plans for a new triangular park. If plotted on a coordinate grid, the vertices would be $A(3, 3)$, $B(5, -2)$, and $C(-3, -1)$. However, a tract of land has become available that would enable the planners to increase the size of the park, which is based on the following transformation of the original triangular park, $R_{270^\circ} \circ D_2$. On the grid below, graph and label both the original park $\triangle ABC$ and its image, the new park $\triangle A''B''C''$, following the transformation.

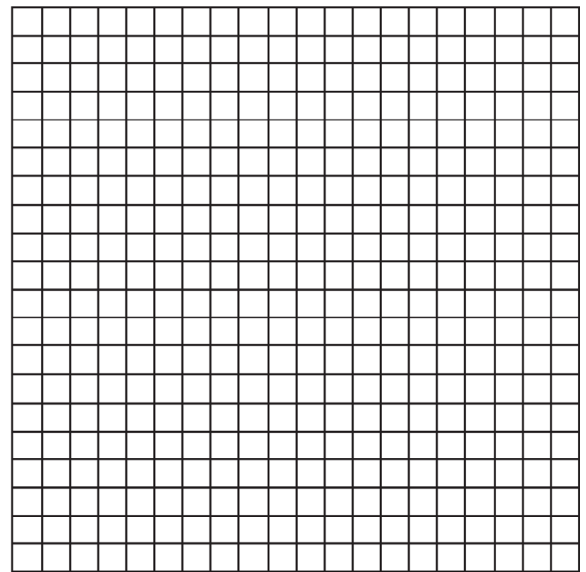

- 31 2009_01_MB_31 Quadratics: Imaginary Solutions
Find the roots of the equation $x^2 + 7 = 2x$ and express your answer in simplest $a + bi$ form.

32 2009_01_MB_32 Systems: Other Nonlinear

On the accompanying grid, graph the following system of equations over the interval $-6 \leq x \leq 6$.

$$x^2 + y^2 = 25$$

$$xy = 12$$

State the points of intersection.

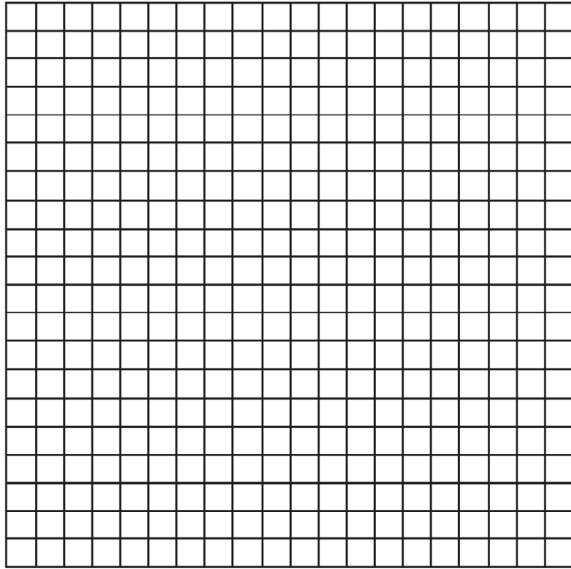

33 2009_01_MB_33 Regression: Logarithmic

The accompanying table shows wind speed and the corresponding wind chill factor when the air temperature is 10°F.

Wind Speed (mi/h) x	Wind Chill Factor (°F) y
4	3
5	1
12	-5
16	-7
22	-10
31	-12

Write the logarithmic regression equation for this set of data, rounding coefficients to the *nearest ten thousandth*. Using this equation, find the wind chill factor, to the *nearest degree*, when the wind speed is 50 miles per hour. Based on your equation, if the wind chill factor is 0, what is the wind speed, to the *nearest mile per hour*?

34 2009_01_MB_34 Proofs: Polygon

Given: $PROE$ is a rhombus, \overline{SEO} , \overline{PEV} , $\angle SPR \cong \angle VOR$

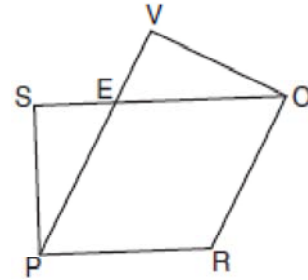

Prove: $\overline{SE} \cong \overline{EV}$

35 2009_06_MB_01 Circles: Radian Measure

The number of degrees equal to $\frac{5}{9} \pi$ radians is

- 1) 45
- 2) 90
- 3) 100
- 4) 900

36 2009_06_MB_02 Functions: Defining

The accompanying graph shows the curves of best fit for data points comparing temperature to altitude in four different regions, represented by the relations A , B , C , and D .

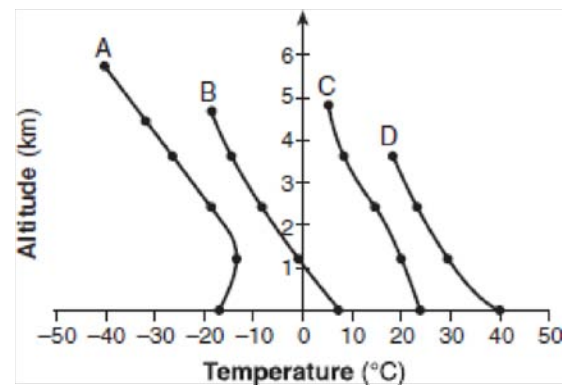

Which relation is *not* a function?

- 1) A
- 2) B
- 3) C
- 4) D

- 37 2009_06_MB_04 Trigonometric Ratios: Cofunction and Reciprocal

If $\sin x = \frac{1}{a}$, $a \neq 0$, which statement must be true?

- 1) $\csc x = a$
- 2) $\csc x = -\frac{1}{a}$
- 3) $\sec x = a$
- 4) $\sec x = -\frac{1}{a}$

- 38 2009_06_MB_05 Radicals: Rationalizing Denominators

The expression $\frac{5 + \sqrt{7}}{5 - \sqrt{7}}$ is equivalent to

- 1) $\frac{16 + 5\sqrt{7}}{16}$
- 2) $\frac{16 + 5\sqrt{7}}{9}$
- 3) $\frac{16 - 5\sqrt{7}}{16}$
- 4) $\frac{16 - 5\sqrt{7}}{9}$

- 39 2009_06_MB_06 Numbers: Complex

When the sum of $-4 + 8i$ and $2 - 9i$ is graphed, in which quadrant does it lie?

- 1) I
- 2) II
- 3) III
- 4) IV

- 40 2009_06_MB_07 Inequalities: Absolute Value

What is the solution of the inequality $|2x - 5| < 1$?

- 1) $x < 3$
- 2) $2 < x < 3$
- 3) $x > -3$
- 4) $x \leq 2$ or $x \geq 3$

- 41 2009_06_MB_08 Transformations: Reflections

Point $A(1, 0)$ is a point on the graph of the equation

$y = x^2 - 4x + 3$. When point A is reflected across the axis of symmetry, what are the coordinates of its image, point A' ?

- 1) $(-1, 2)$
- 2) $(0, 3)$
- 3) $(2, -1)$
- 4) $(3, 0)$

- 42 2009_06_MB_09 Exponential Growth

The accompanying diagram represents the biological process of cell division.

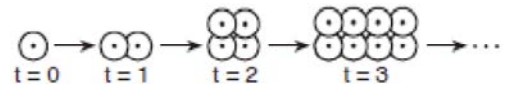

If this process continues, which expression best represents the number of cells at any time, t ?

- 1) $t + 2$
- 2) $2t$
- 3) t^2
- 4) 2^t

- 43 2009_06_MB_10 Quadratics: Using the Discriminant

The roots of $x^2 - 5x + 1 = 0$ are

- 1) real, rational, and unequal
- 2) real, rational, and equal
- 3) real, irrational, and unequal
- 4) imaginary

- 44 2009_06_MB_11 Transformations: Dilations

Using a drawing program, a computer graphics designer constructs a circle on a coordinate plane on her computer screen. She determines that the equation of the circle's graph is

$(x - 3)^2 + (y + 2)^2 = 36$. She then dilates the circle with the transformation D_3 . After this

transformation, what is the center of the new circle?

- 1) $(6, -5)$
- 2) $(-6, 5)$
- 3) $(9, -6)$
- 4) $(-9, 6)$

45 2009_06_MB_12 Exponents

Which expression is equivalent to $\left(\sqrt{a^2 b^{\frac{1}{2}}}\right)^{-1}$?

- 1) $a^{-2} b^{-\frac{1}{2}}$
- 2) $-ab^{\frac{1}{4}}$
- 3) $-ab^2$
- 4) $\frac{1}{ab^{\frac{1}{4}}}$

46 2009_06_MB_13 Families of Functions

The accompanying graph shows the average daily readership, in thousands, of the newspaper "El Diario La Prensa."

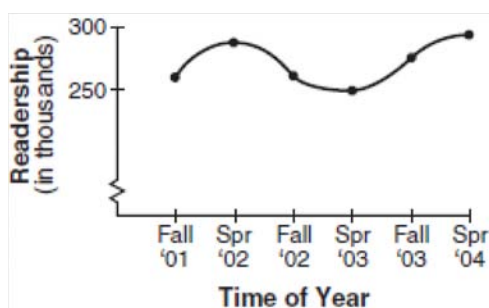

Which type of function best represents this graph?

- 1) exponential
- 2) logarithmic
- 3) trigonometric
- 4) quadratic

47 2009_06_MB_14 Trigonometric Identities: Double and Half Angle

The expression $\frac{\sin 2A}{2 \cos A}$ is equivalent to

- 1) $\cos A$
- 2) $\tan A$
- 3) $\sin A$
- 4) $\frac{1}{2} \sin A$

48 2009_06_MB_15 Radicals: Solving

What is the solution set of the equation

$$y = 2 + \sqrt{y^2 - 12}$$

- 1) $\{ \}$
- 2) $\{2\}$
- 3) $\{-4, 4\}$
- 4) $\{4\}$

49 2009_06_MB_16 Binomial Expansions

What is the third term in the expansion $(2x - 3)^5$?

- 1) $-1080x^2$
- 2) $-720x^3$
- 3) $720x^3$
- 4) $1080x^3$

50 2009_06_MB_17 Central Tendency: Dispersion

The accompanying table shows the scores on a classroom test.

x_j	f_j
100	7
90	10
80	4
70	4

What is the population standard deviation for this set of scores?

- 1) 10.2
- 2) 10.4
- 3) 25
- 4) 88

51 2009_06_MB_18 Variation: Inverse

The manager of Stuart Siding Company found that the number of workers used to side a house varies inversely with the number of hours needed to finish the job. If four workers can side the house in 48 hours, how many hours will it take six workers working at the same speed to do the same job?

- 1) 32
- 2) 36
- 3) 42
- 4) 72

52 2009_06_MB_19 Fractions: Complex

The expression $\frac{1 - \frac{x}{x-y}}{\frac{1}{x-y}}$

- 1) $1 - x$
- 2) $1 - y$
- 3) y
- 4) $-y$

53 2009_06_MB_20 Trigonometric Functions: Properties of
The Sea Dragon, a pendulum ride at an amusement park, moves from its central position at rest according to the trigonometric function

$$P(t) = -10 \sin\left(\frac{\pi}{3} t\right), \text{ where } t \text{ represents time, in}$$

seconds. How many seconds does it take the pendulum to complete one full cycle?

- 1) 5
- 2) 6
- 3) 3
- 4) 10

54 2009_06_MB_21 Functions: Compositions of

If $f(x) = x^2 + 4$ and $g(x) = 2x + 3$, find $f(g(-2))$.

55 2009_06_MB_22 Trigonometry: Law of Sines

In $\triangle ABC$, $\sin A = 0.6$, $a = 10$, and $b = 7$. Find $\sin B$.

56 2009_06_MB_23 Exponential Functions and Equations

Solve algebraically for x : $9^{3x} = 3^{3x+1}$

57 2009_06_MB_24 Circles: Tangents

The accompanying diagram shows two lengths of wire attached to a wheel, so that \overline{AB} and \overline{AC} are tangent to the wheel. If the major arc \widehat{BC} has a measure of 220° , find the number of degrees in $m\angle A$.

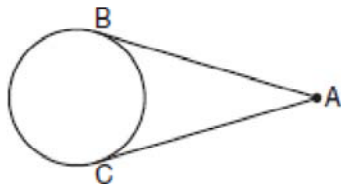

58 2009_06_MB_25 Equations: Logarithmic

Solve for x : $\log_8(x + 1) = \frac{2}{3}$

59 2009_06_MB_26 Functions: Inverses of

The accompanying graph shows the relationship between the cooling time of magma and the size of the crystals produced after a volcanic eruption. On the same graph, sketch the inverse of this function.

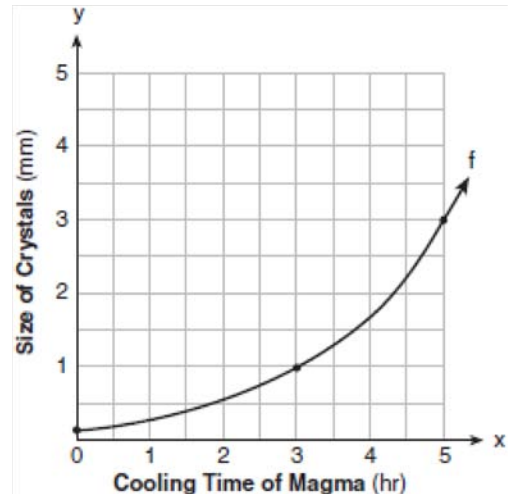

60 2009_06_MB_27 Regression: Linear

The number of newly reported crime cases in a county in New York State is shown in the accompanying table. Write the linear regression equation that represents this set of data. (Let $x = 0$ represent 1999.) Using this equation, find the projected number of new cases for 2009, rounded to the nearest whole number.

Year (x)	New Cases (y)
1999	440
2000	457
2001	369
2002	351

- 61 2009_06_MB_28 Transformations: Compositions of
 On the accompanying grid, graph and label $\triangle ABC$ with vertices $A(3, 1)$, $B(0, 4)$, and $C(-5, 3)$. On the same grid, graph and label $\triangle A''B''C''$, the image of $\triangle ABC$ after the transformation $r_{x\text{-axis}} \circ r_{y=x}$.

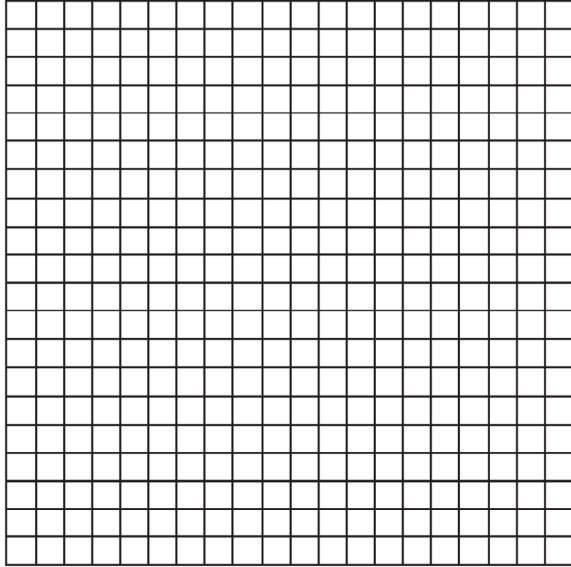

- 65 2009_06_MB_32 Trigonometric Equations
 Solve the equation $\cos \theta = 2 + 3 \cos 2\theta$ for all values of θ , to the nearest tenth of a degree, in the interval $0^\circ \leq \theta < 360^\circ$.

- 66 2009_06_MB_33 Polygons: Area of
 The accompanying diagram shows a triangular plot of land located in Moira's garden.

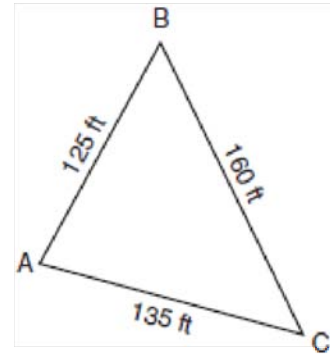

Find the area of the plot of land, and round your answer to the nearest hundred square feet.

- 62 2009_06_MB_29 Rationals: Addition and Subtraction of
 Express in simplest form: $\frac{3x}{2x-6} + \frac{9}{6-2x}$

- 63 2009_06_MB_30 Probability: Binomial with "At Least or At Most"
 Dave does *not* tell the truth $\frac{3}{4}$ of the time. Find the probability that he will tell the truth *at most* twice out of the next five times.

- 64 2009_06_MB_31 Perimeter
 In the accompanying diagram, \overline{CD} is an altitude of $\triangle ABC$. If $CD = 8$, $m\angle A = 45^\circ$, and $m\angle B = 30^\circ$, find the perimeter of $\triangle ABC$ in simplest radical form.

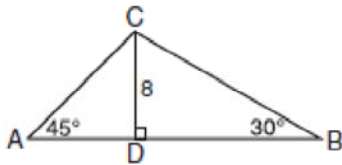

- 67 2009_06_MB_34 Proofs: Circle
 In the accompanying diagram of circle O , \overline{AD} is a diameter with \overline{AD} parallel to chord \overline{BC} , chords \overline{AB} and \overline{CD} are drawn, and chords \overline{BD} and \overline{AC} intersect at E .
 Prove: $\overline{BE} \cong \overline{CE}$

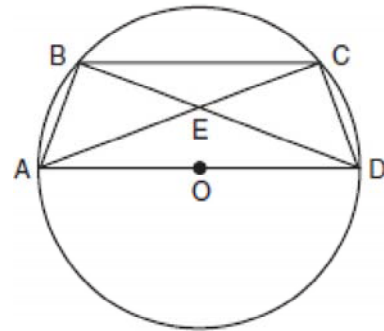

- 68 2009_08_MB_01 Graphs: Identifying Equations of
Which equation is represented by the accompanying graph?

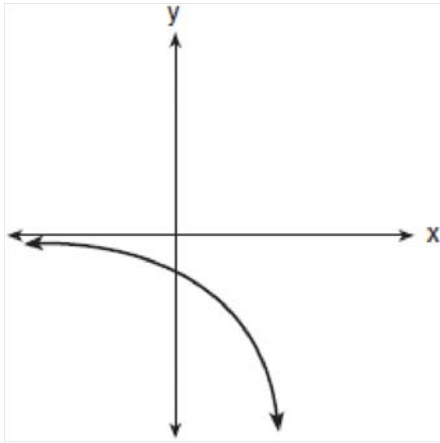

- 1) $y = 2^x$
 2) $y = -2^x$
 3) $y = 2^{-x}$
 4) $y = x^2 - 2$
- 69 2009_08_MB_02 Quadratics: Find Vertex Given Equation
What are the coordinates of the turning point of the parabola whose equation is $y = -x^2 + 4x + 1$?
- 1) $(-2, -11)$
 2) $(-2, -3)$
 3) $(2, 5)$
 4) $(2, 13)$

- 70 2009_08_MB_03 Trigonometric Functions: Properties of
The graph of the equation $y = |\sin x|$ will contain *no* points in Quadrants
- 1) I and II
 2) II and III
 3) III and IV
 4) I and IV

- 71 2009_08_MB_04 Summations

What is the value of $\sum_{k=0}^2 3(2)^k$?

- (1) 15
 (2) 19
 (3) 21
 (4) 43

- 72 2009_08_MB_05 Numbers: Complex
Expressed in simplest form, $\frac{\sqrt{-20}}{\sqrt{5}}$ is equivalent

to

- 1) $-2i$
 2) $2i$
 3) $\sqrt{2}i$
 4) $\frac{2i}{\sqrt{5}}$

- 73 2009_08_MB_06 Numbers: Complex
On a graph, if point A represents $2 - 3i$ and point B represents $-2 - 5i$, which quadrant contains $3A - 2B$?

- 1) I
 2) II
 3) III
 4) IV

- 74 2009_08_MB_07 Proofs: Triangle
In the accompanying diagram of triangles BAT and FLU , $\angle B \cong \angle F$ and $BA \cong FL$.

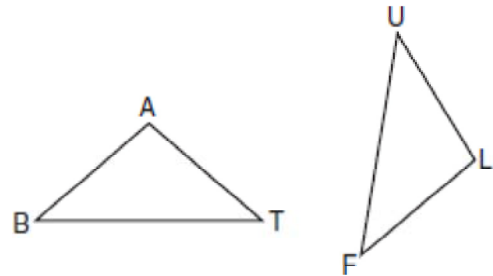

Which statement is needed to prove $\triangle BAT \cong \triangle FLU$?

- 1) $\underline{\angle A} \cong \underline{\angle L}$
 2) $\underline{AT} \cong \underline{LU}$
 3) $\underline{\angle A} \cong \underline{\angle U}$
 4) $\underline{BA} \parallel \underline{FL}$

- 75 2009_08_MB_08 Transformations: Classifications of
Which type of transformation is

$(x, y) \rightarrow (x + 2, y - 2)$?

- 1) dilation
 2) reflection
 3) rotation
 4) translation

- 76 2009_08_MB_09 Trigonometric Functions: Properties of
Which functions are positive for angles terminating in Quadrant II?
- 1) sine and cosine
 - 2) sine and secant
 - 3) sine and tangent
 - 4) sine and cosecant

- 77 2009_08_MB_10 Radicals: Rationalizing Denominators
What is $\sqrt{\frac{4}{3}} - \sqrt{\frac{3}{4}}$ expressed in simplest form?

- 1) 1
- 2) 0
- 3) $\frac{\sqrt{3}}{6}$
- 4) $2\sqrt{3}$

- 78 2009_08_MB_11 Logarithms
Banks use the formula $A = P(1 + r)^x$ when they compound interest annually. If P represents the amount of money invested and r represents the rate of interest, which expression represents $\log A$, where A represents the amount of money in the account after x years?
- 1) $x \log P + \log(1 + r)$
 - 2) $\log P + x \log(1 + r)$
 - 3) $\log P + x \log 1 + r$
 - 4) $\log P + \log x + \log(1 + r)$

- 79 2009_08_MB_12 Quadratics: Axis of Symmetry
If the equation of the axis of symmetry of a parabola is $x = 2$, at which pair of points could the parabola intersect the x -axis?
- 1) (3,0) and (5,0)
 - 2) (3,0) and (2,0)
 - 3) (3,0) and (1,0)
 - 4) (-3,0) and (-1,0)

- 80 2009_08_MB_13 Variation: Inverse
Jack is driving from New York to Florida. The number of hours that he drives and the speed at which he drives are inversely proportional. Which graph could be used to describe this situation if one axis represents speed and the other represents hours?

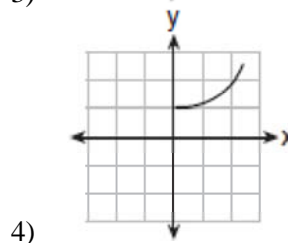
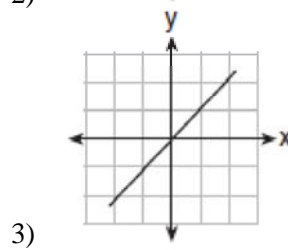
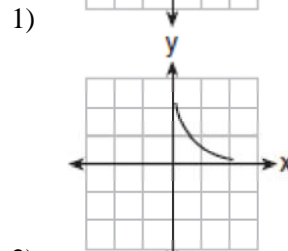
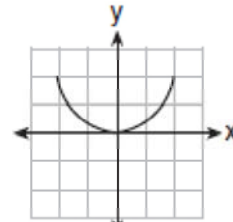

- 81 2009_08_MB_14 Triangles: Equilateral
What is the length of the altitude of an equilateral triangle whose side has a length of 8?
- 1) 32
 - 2) $4\sqrt{2}$
 - 3) $4\sqrt{3}$
 - 4) 4

82 2009_08_MB_15 Binomial Expansions
What is the third term in the expansion of $(3x - 2)^5$?

- 1) $1,080x^2$
- 2) $270x^3$
- 3) $540x^3$
- 4) $1,080x^3$

83 2009_08_MB_16 Transformations: Isometries
If the dilation D_k is an isometry, what must be the value of k ?

- 1) 1
- 2) 2
- 3) -2
- 4) 0

84 2009_08_MB_17 Functions: Compositions of
If $f(x) = x^2$ and $g(x) = 2x + 1$, which expression is equivalent to $(f \circ g)(x)$?

- 1) $2x^2 + 1$
- 2) $2(x + 1)^2$
- 3) $4x^2 + 1$
- 4) $4x^2 + 4x + 1$

85 2009_08_MB_18 Functions: Inverses of
What is the inverse of the function $y = 2x - 3$?

- 1) $y = \frac{x+3}{2}$
- 2) $y = \frac{x}{2} + 3$
- 3) $y = -2x + 3$
- 4) $y = \frac{1}{2x-3}$

86 2009_08_MB_19 Transformations: Reflections
If $a > 0$, which function represents the reflection of $y = a^x$ in the y -axis?

- 1) $y = -a^x$
- 2) $y = \left(\frac{1}{a}\right)^x$
- 3) $y = \left(\frac{1}{a}\right)^{-x}$
- 4) $x = a^y$

87 2009_08_MB_20 Conics
The graph of the equation $2x^2 - 3y^2 = 4$ forms

- 1) a circle
- 2) an ellipse
- 3) a hyperbola
- 4) a parabola

88 2009_08_MB_21 Exponents
Evaluate the expression

$$(x+3)^{\frac{1}{2}} + (x-3)^0 + (x+2)^{-\frac{2}{3}} \text{ when } x = 6.$$

89 2009_08_MB_22 Exponential Functions and Equations
Solve algebraically for x : $27^x = 9^{x+2}$

90 2009_08_MB_23 Equations: Absolute Value
Solve for the negative value of x : $|2x + 5| + 1 = 13$

91 2009_08_MB_24 Equations: Literal
In physics class, Esther learned that force due to gravity can be determined by using the formula $F = \frac{Gm_1m_2}{r^2}$. Solve for r in terms of F , G , m_1 , and m_2 .

92 2009_08_MB_25 Circles: Chords, Secants and Tangents
In the accompanying diagram of circle O , \overline{PC} is a tangent, \overline{PBA} is a secant, $m\widehat{AB} = 132$, and $m\widehat{CB} = 46$. Find $m\angle P$.

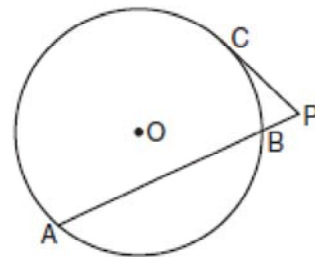

- 93 2009_08_MB_26 Graphs: Identifying Equations of
The accompanying graph shows a trigonometric function. State an equation of this function.

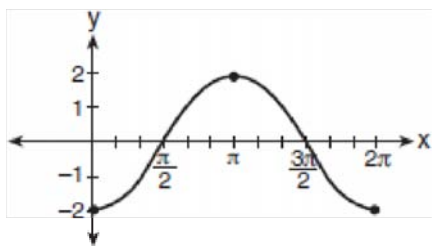

- 94 2009_08_MB_27 Regression: Power
Kathy swims laps at the local fitness club. As she times her laps, she finds that each succeeding lap takes a little longer as she gets tired. If the first lap takes her 33 seconds, the second lap takes 38 seconds, the third takes 42 seconds, the fifth takes 50 seconds, and the seventh lap takes 54 seconds, state the power regression equation for this set of data, rounding all coefficients to the *nearest hundredth*. Using your written regression equation, estimate the number of seconds that it would take Kathy to complete her tenth lap, to the *nearest tenth of a second*.

- 95 2009_08_MB_28 Probability: Binomial with "At Least or At Most"
Dave is the manager of a construction supply warehouse and notes that 60% of the items purchased are heating items, 25% are electrical items, and 15% are plumbing items. Find the probability that *at least* three out of the next five items purchased are heating items.

- 96 2009_08_MB_29 Central Tendency: Normal Distributions
The heights of a sample of female students at Oriskany High School are normally distributed with a mean height of 65 inches and a standard deviation of 0.6 inch. What percent of this sample is between 63.8 inches and 66.2 inches? Above what height, in inches, would the top 2.3% of this sample population be found?

- 97 2009_08_MB_30 Fractions: Complex

Express in simplest form:
$$\frac{\frac{5}{a+b} - \frac{5}{a-b}}{\frac{10}{a^2 - b^2}}$$

- 98 2009_08_MB_31 Quadratics: $a > 1$
Solve the equation $3x^2 + 5 = 4x$ and express the roots in simplest $a + bi$ form.

- 99 2009_08_MB_32 Similarity: Right Triangles
The drawing for a right triangular roof truss, represented by $\triangle ABC$, is shown in the accompanying diagram. If $\angle ABC$ is a right angle, altitude $\overline{BD} = 4$ meters, and \overline{DC} is 6 meters longer than \overline{AD} , find the length of base \overline{AC} in meters.

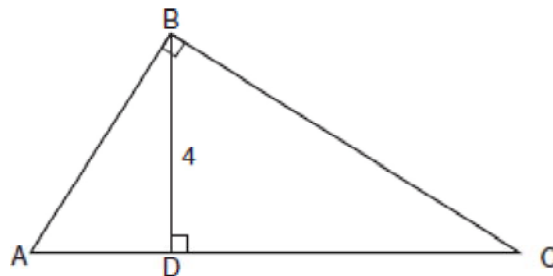

100 2009_08_MB_33 Proofs: Coordinate

Given: $T(-1, 1)$, $R(3, 4)$, $A(7, 2)$, and $P(-1, -4)$

Prove: $TRAP$ is a trapezoid.

$TRAP$ is not an isosceles trapezoid.

[The use of the grid is optional.]

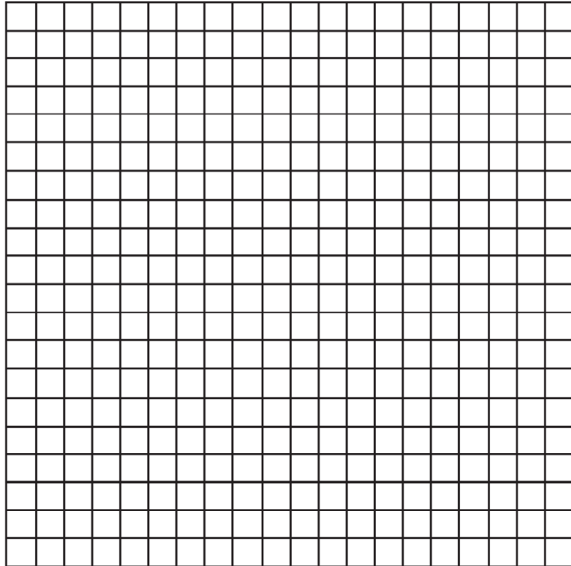

101 2009_08_MB_34 Trigonometry: Law of Cosines

Firefighters dug three trenches in the shape of a triangle to prevent a fire from completely destroying a forest. The lengths of the trenches were 250 feet, 312 feet, and 490 feet. Find, to the *nearest degree*, the *smallest* angle formed by the trenches. Find the area of the plot of land within the trenches, to the *nearest square foot*.

MP - The Preliminary Math Curriculum (1950)

- 1 1950_01_MP_01 Arithmetic: Addition
Add 6498; 825; 57; 907; 6870; 8781; 968
- 2 1950_01_MP_02 Arithmetic: Multiplication
Multiply \$39.50 by 10
- 3 1950_01_MP_03 Arithmetic: Division
Divide 6.9525 by 7.5
- 4 1950_01_MP_04 Arithmetic: Subtraction
Subtract 387.5 from 400
- 5 1950_01_MP_05 Fractions
Add $82\frac{2}{3}$; $15\frac{3}{4}$; $11\frac{1}{6}$
- 6 1950_01_MP_06 Fractions
Find the product of $16\frac{2}{3}$ and 18
- 7 1950_01_MP_07 Proportions
If lemons sell at 3 for 19 cents, what is the cost per dozen?
- 8 1950_01_MP_08 Central Tendency: Averages
In six tests Walter had scores of 80, 90, 100, 70, 90 and 80. What was his average score?
- 9 1950_01_MP_09 Special Quadrilaterals
The area of a square flower bed is 64 square feet. What is the length of one side?
- 10 1950_01_MP_10 Mensuration
If the temperature dropped from 2 degrees above zero to 10 degrees below zero, how many degrees did it drop?
- 11 1950_01_MP_11 Percent
If a boy makes 16 free throws out of 20 tries, what per cent does he make?
- 12 1950_01_MP_12 Proportions
A certain school has a one-quarter mile track on its playground. How many times around the track would a boy have to run to complete a mile?
- 13 1950_01_MP_13 Proportions
At 25 cents each, how many school lunches can be bought for \$6?
- 14 1950_01_MP_14 Proportions
On Thursday, a family had spent \$48, which was 80% of its weekly budget. How much was the budget?
- 15 1950_01_MP_15 Mensuration
A girl was born on June 2, 1937. How old will she be on her next birthday?
- 16 1950_01_MP_16 Proportions
Billy is making a knot exhibit. If he allows 20 inches of rope for each knot, how many feet of rope will he need to make 18 knots?
- 17 1950_01_MP_17 Proportions
How far can an airplane travel in 15 minutes if it travels at an average speed of 240 miles an hour?
- 18 1950_01_MP_18 Proportions
A house was insured for \$4000 at a premium of 60 cents per \$100. What was the premium?
- 19 1950_01_MP_19 Arithmetic: Subtraction
Mt. Marcy, the highest peak in New York State, is 5344 feet above sea level. How much higher than a mile above sea level is Mt. Marcy?
- 20 1950_01_MP_20 Percent
A piano marked to sell for \$600 is sold for \$400. What is the rate of discount based on the marked price?
- 21 1950_01_MP_21 Ratio
What is the ratio of a month to a year?

22 1950_01_MP_22 Equations and Expressions: Modeling
 Represent the cost of 40 tons of coal at d dollars per ton.

23 1950_01_MP_23 Equations: Simple
 Find the value of x in the equation: $5x - 3 = 12$

24 1950_01_MP_24 Equations and Expressions: Using Substitution in
 The formula for the area of a sphere is $A = \pi r^2$.
 Find the value of A if $\pi = \frac{22}{7}$ and $r = 7$.

25 1950_01_MP_25 Triangles: Interior and Exterior Angles of
 Two angles of a triangle measure 75° and 45° .
 How many degrees are there in the third angle?

26 1950_01_MP_ii_01 Numbers: Comparing Real
 According to the 1940 census there were five cities in the United States with populations of one million or more. Using the following figures, answer the questions below.

- Detroit 1,623,452
- New York 7,454,995
- Chicago 3,396,808
- Philadelphia 1,931,334
- Los Angeles 1,504,277

- a List the cities in order of population, from largest to smallest. [4]
- b What is the difference in population between the largest and the smallest of the cities? [3]
- c The population of 713,346 was the smallest for any state in the United States according to the 1940 census. About how many times greater was the population of New York City than that of the smallest state in 1940? [3]

27 1950_01_MP_ii_02 Bills and Receipts
 A boy who worked in Friend's Grocery made daily deposits in the bank for the store. On January 23, 1950, he took the following to the bank for deposit: \$200.00 in bills (currency) \$10.00 in half dollars
 15.00 in quarters 6.00 in nickels
 8.00 in dimes 4.00 in pennies
 and a check from Anytown Bank for \$24.50.
 Using the information above fill in the form below.
 [10]

Deposited in		
OURTOWN FIRST BANK		
Ourtown, N. Y.		
		19.....
for account of		
List each check separately.		
Bills		
Coin		
Checks :		
Total		

28 1950_01_MP_ii_03 Cost
 Jane, Who was visiting a cousin, sent her mother a 13-word telegram. The charge was 51 cents for the first ten words, and 3 cents for each additional word. There was also a 25% tax on the total cost of the telegram.
 a How much charge (without tax) was there for the additional words? [2]
 b What was the total cost of the telegram, including tax? [8]

29 1950_01_MP_ii_04 Profit and Loss
 Last year Jimmy Potter raised five puppies. After a time he sold them all for \$10 each. During the time he kept them he had the following expenses: food, \$19.75; veterinarian's fees, \$9.00; other expenses, \$11.25.

- a* What was the total expense for the care of the puppies? [2]
b What was the total income from the sale of the puppies? [2]
c How much profit did he make? [2]
d What per cent of the selling price was profit? [4]

30 1950_01_MP_ii_05 Equations and Expressions: Modeling
 A Change *each* of the following rules into formulas:

(*a*) When you multiply the Area of the base (*A*) of a cylinder by its height (*h*), you get its Volume (*V*). [3]

(*b*) When you divide the product of the base (*b*) and height (*h*) of a triangle by 2, you get its Area (*A*). [3]

B Change the following formula for the area of a circle into a rule: $A = \pi r^2$ [4]

31 1950_01_MP_ii_06 Percent

Mrs. Jones can buy a new refrigerator listed to sell for \$300 with a 10% discount for cash or \$30 down payment and \$16.50 a month for 18 months.

- a* How much will the refrigerator cost Mrs. Jones if she pays cash? [3]
b How much will Mrs. Jones pay if she buys on the installment plan? [5]
c How much can she save by paying cash? [2]

32 1950_01_MP_ii_07 Cost

a How much did it cost Mr. Williams to run his car for a year if his expenses were: license fees, \$14.50; automobile insurance, \$48; depreciation, \$230; repairs and supplies, \$29.90; garage rent at \$7 per month; gasoline, 620 gallons at 23 cents per gallon; oil, 36 quarts at 25 cents per quart? [6 J]

b If Mr. Williams drove his car 9300 miles during the year, what was the cost per mile to drive the car? [4]

33 1950_01_MP_ii_09 Solid Geometry: Prisms and Cylinders
 The cylindrical tank illustrated below has a diameter of 70 inches and a height of 96 inches.

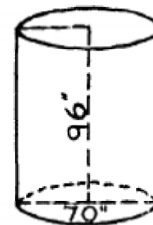

a Find the radius of the tank. [2]

b Using the formula $V = r^2 \pi h$, find the volume of the tank in cubic inches.

$$\left(\pi = \frac{22}{7} \right) \quad [4]$$

c How many gallons of water will the tank hold if one gallon of water occupies 231 cubic inches? [4]

34 1950_01_MP_ii_08a Mensuration

How great is the change in temperature from -8° to 20° ? [2]

35 1950_01_MP_ii_08b Equations and Expressions: Using Substitution in

If $x = 3$ and $y = 4$, what is the value of $x^2 + 2y - x$? [2]

36 1950_01_MP_ii_08c Equations: Simple

If $2x = 6$, what is the value of $3x$? [2]

37 1950_01_MP_ii_08d Equations: Simple

Solve for x in the equation: $3x = x + 6$ [2]

38 1950_01_MP_ii_08e Equations: Simple

Solve for y in the equation: $\frac{y}{4} = 3$ [2]

39 1950_06_MP_01 Arithmetic: Addition

Add 4.98; 62.5; 3.865; 587

40 1950_06_MP_02 Arithmetic: Subtraction

Find the difference between 34165 and 29602

41 1950_06_MP_03 Decimals

Multiply 37.5 by .083

- 42 1950_06_MP_04 Fractions
Add $2\frac{1}{8}$; $5\frac{3}{4}$; $8\frac{1}{2}$
- 43 1950_06_MP_05 Proportions
At the rate of 48 cents per dozen, how much will 3 eggs cost?
- 44 1950_06_MP_06 Arithmetic: Addition
Add 13812; 21305; 12429; 16496; 19763
- 45 1950_06_MP_07 Arithmetic: Division
In a certain school there are 108 boys. How many intramural baseball teams (nine boys on a team) can they form, using all the boys?
- 46 1950_06_MP_08 Central Tendency: Averages
The total weight of the eleven players on a high school football team is 1716 pounds. What is their average weight?
- 47 1950_06_MP_09 Notes and Interest
Mr. White's farm is mortgaged for \$2200. At a rate of 5%, what is the annual interest charge for the mortgage?
- 48 1950_06_MP_10 Arithmetic: Division
How many times greater is 90 than 15?
- 49 1950_06_MP_11 Fraction Madness
A boy spent one third of his money for a tennis racquet and one fifth of his money for balls. What fractional part of his money did he spend?
- 50 1950_06_MP_12 Arithmetic: Subtraction
Joe used 7 ft. 4 in. of leather lacing to bind his scrapbook and Jim used 9 ft. 2 in. for his. How much more did Jim use than Joe?
- 51 1950_06_MP_13 Numbers: Comparing Real
Which is the greatest: $\frac{3}{4}$; .80; 66%?
- 52 1950_06_MP_14 Percent
In a group of 21 girls were 14 Girl Scouts. What per cent of the 21 were Scouts?
- 53 1950_06_MP_15 Equations: Simple
What is the value of x in the equation $5x + 14 = 24$?
- 54 1950_06_MP_16 Volume
If a rectangle 12 feet long has an area of 108 square feet, what is the width of the rectangle?
- 55 1950_06_MP_17 Cost
At 10 cents a square foot, what is the cost of cleaning a rug that is 9 feet long and 6 feet wide?
- 56 1950_06_MP_18 Equations: Simple
If $3x = 18$, what does $2x$ equal?
- 57 1950_06_MP_19 Arithmetic: Multiplication
30 inches of leather will make one belt. How many feet of leather would be needed to make 12 belts?
- 58 1950_06_MP_20 Equations: Simple
If $x - 2 = 5$, what is the value of x ?
- 59 1950_06_MP_21 Proportions
The ratio of the width of a banner to its length is 11 to 19. If the banner is 44 inches wide, what is its length?
- 60 1950_06_MP_22 Proportions
The scale of miles on a certain map is 1 in. = 50 miles. How long a line will have to be drawn on the map to show a distance of 1000 miles?
- 61 1950_06_MP_23 Equations and Expressions: Modeling
Write the formula for the number of minutes (m) in h hours.
- 62 1950_06_MP_24 Complementary, Vertical and Supplementary Angles
How many degrees less than a right angle is an angle of 74° ?
- 63 1950_06_MP_25 Brokerage and Commission
A salesman sold \$1850 worth of merchandise on a commission of 35%. How much was his commission?

64 1950_06_MP_ii_01 Cost

A boy who works in a grocery store finds that he often has to figure prices on odd units of weight. Following are some typical sales. In each case figure the cost to the nearest penny, making sure that any fractional part of one cent is counted as an extra cent.

- a 5 lb. 3 oz. of cabbage @ 4¢ per pound [2]
- b 8 lemons @ 2 for 11¢ [2]
- c 6 lb. of sweet potatoes @ 2 lb. for 17¢ [2]
- d 8 oz. of cheese @ 59¢ per pound [2]
- e 15 lb. of potatoes @ \$3 per hundred lb. [2]

65 1950_06_MP_ii_02 Ratio

Two boys went into the window cleaning business on a partnership basis. Joe invested 40% of the money to buy equipment and Jim invested 60%. They agreed to divide their earnings in proportion to their investments. Their investments totaled \$30. During the year they took in a total of \$420.

- a How much did each boy invest? [4]
- b How much profit did each boy receive? [4]
- c How many times greater were Joe's earnings than his original investment? [2]

66 1950_06_MP_ii_03 Graphic Representation: Histograms and Tables

On the accompanying form make a bar graph to show a comparison of the heights of some of the notable tall buildings in New York City. [10]

Structure No.	Name	Height
1	Empire State	1250 ft.
2	Chrysler	1046 ft.
3	60 Wall Tower	950 ft.
4	Bank of Manhattan	927 ft.
5	RCA (Rockefeller Center)	850 ft.
6	Woolworth	792 ft.
7	Farmers Trust	741 ft.
8	Metropolitan Life	700 ft.
9	Chanin	680 ft.
10	Lincoln	673 ft.

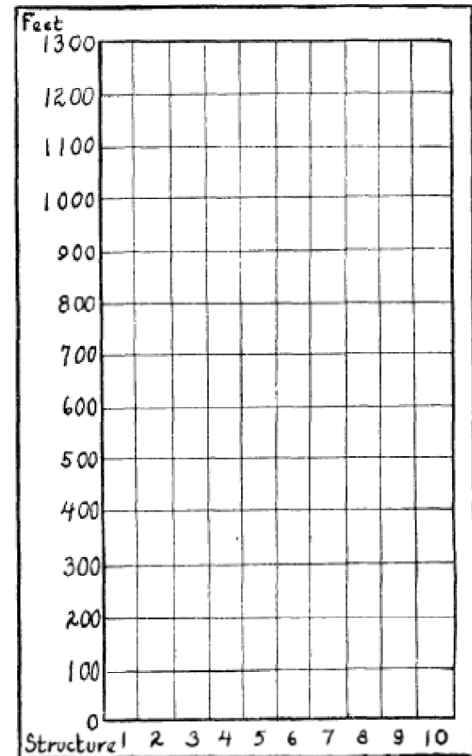

- 67 1950_06_MP_ii_04 Cost
Mr. Jones with his wife and three children took a vacation trip. The expenses were as follows: gasoline, 100 gallons at 24 cents a gallon; oil, 6 quarts at 40 cents a quart; car repairs, \$19; hotel bill, \$10 for the family per night for 5 nights; food, \$12 for the family per day for 6 days; entertainment, \$35.40 for the entire trip; miscellaneous, \$12.50.
a What was the total expense for the trip? (8J)
b What was the average cost of the trip for each member of the family? [2]

- 68 1950_06_MP_ii_05 Proportions
In each of the following problems you will find a fact missing. In each case add a fact that will make the problem complete and then solve the problem. [Example: How far can an airplane travel if it travels at an average speed of 240 miles per hour?
240 miles per hour
× 2 hours _____
480 miles Ans
a If you buy five pounds of butter, how much change should you receive from a five-dollar bill? [2]
b At \$20 per ton, what is the cost of a load of coal? [2]
c What is the interest on \$200 for one year? [2]
d How many square feet are there in a rectangle that is 20 feet long? [2]
e A basketball team played 16 games. What per cent of the games played did this team win? [2]

- 69 1950_06_MP_ii_06 Brokerage and Commission
Miss Helen Jones is employed as a saleslady in a department store. She is paid \$30 a week salary and a commission of 4% on all sales above \$200. During a certain week Miss Jones sold merchandise totalling \$730.
a How much commission did Miss Jones earn during the week? [8]
b What were Miss Jones' total earnings for the week? [2]

- 70 1950_06_MP_ii_07 Cost
Mr. Brown purchased a television set listed for \$199.50. He made a down payment of \$19.50 and made a contract to pay the balance in 18 installments of \$12 each.
a How much did the television set really cost when all payments were complete? [8]
b How much could Mr. Brown have saved by paying cash? [2]

- 71 1950_06_MP_ii_08 Equations: Simple
a Solve for n in the following equations:
(1) $\frac{n}{5} = 20$ [2]
(2) $n - 5 = 20$ [2]
b Add: $2x + y + 3y - x - y$ [2]
c Choose the correct equation for each of the following:
(1) A caddy had n golf balls. After finding 14 more, he had 37. How many balls did he have before he added the ones found? [2]
 $n - 14 = 37$ $\frac{n}{14} = 37$
 $n + 14 = 37$
(2) A boy spends \$2 or $\frac{1}{4}$ of his money
(m). How much money did he have in the beginning? [2]
 $\frac{m}{4} = \$2$ $m + \frac{1}{4} = 14$
 $4m = 14$

- 72 1950_06_MP_ii_09 Circles: Area of

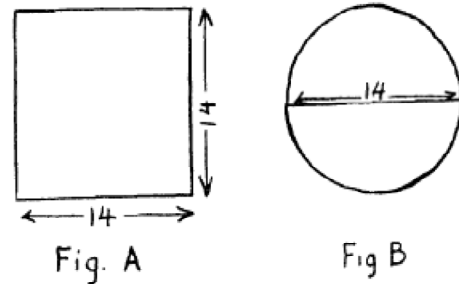

Using $\pi = \frac{22}{7}$;

- a Find the area of each of the above figures. [5]
b Find the perimeter of each of the above figures. [5]

NY - The Ninth Year Curriculum (1970-1980)

- 1 1970_06_NY_01 Quadratics: Using the Discriminant
Evaluate the expression $b^2 - 4ac$ when $b = -3$, $a = 1$, and $c=2$.
- 2 1970_06_NY_02 Numbers: Properties of Real
What number is the additive inverse of 9?
- 3 1970_06_NY_03 Rationals: Addition and Subtraction of
Express as a single fraction: $\frac{2}{3x} + \frac{a}{2x}$
- 4 1970_06_NY_04 Equations: Simple
Solve for x : $7x + 6 = 3x - 14$
- 5 1970_06_NY_05 Equations: Simple with Decimals
Find the solution set of $.08x = 72$.
- 6 1970_06_NY_06 Rationals: Solving
Solve for x : $\frac{2}{3} = \frac{8}{x}$
- 7 1970_06_NY_07 Equations and Expressions: Modeling
Express in terms of x the perimeter of a rectangle whose width is represented by x and whose length is represented by $2x$.
- 8 1970_06_NY_08 Radicals: Square Roots
Find the positive square root of 61 to the *nearest tenth*.
- 9 1970_06_NY_09 Rationals: Addition and Subtraction of
Perform the indicated operations and express the result in *simplest form*:
 $\frac{x+1}{2y-2} + \frac{x+1}{y-1}$
- 10 1970_06_NY_10 Slope
What is the slope of the line whose equation is $3y = 2x - 5$?
- 11 1970_06_NY_11 Quadratics: Difference of Perfect Squares
Factor $9x^2 - 16$
- 12 1970_06_NY_12 Rate
Represent in terms of m , the number of seconds in m minutes and 8 seconds.
- 13 1970_06_NY_13 Polynomials: Multiplication and Division of
Express as a trinomial: $(2x + 1)(3x - 2)$
- 14 1970_06_NY_14 Trigonometric Functions: Inverses of
If $\cos x = .5446$, what is the number of degrees in the measure of angle x ?
- 15 1970_06_NY_15 Equations: Literal
Solve for x in terms of a , b , and c : $ax + bx = c$
- 16 1970_06_NY_16 Complementary, Supplementary and Vertical Angles
If two supplementary angles are in the ratio of 1:3, find the number of degrees in the measure of the *smaller* angle.
- 17 1970_06_NY_17 Exponents: Operations with
Express in *lowest terms*: $\frac{-35x^2y^2}{45x^2y^2}$
- 18 1970_06_NY_18 Absolute Value
Find the value of $|-8| - |2|$.
- 19 1970_06_NY_19 Arithmetic: Place Value
If t represents the tens digit of a two-digit number and u is the units digit, represent the number in terms of t and u .
- 20 1970_06_NY_20 Set Theory
The set $\{a, b, c, d\}$ is equivalent to which set?
(1) $\{d\}$
(2) $\{a,b,c\}$
(3) $\{5,9,13\}$
(4) $\{1,2,3,4\}$

- 21 1970_06_NY_21 Sets: Replacement
If the replacement set for x is the set of positive integers, then the solution set for $\frac{\pi}{4} + 4 < 2$ is
- (1) { }
 - (2) {1,2,3,...7}
 - (3) {1,2,3,...8}
 - (4) {1,2,3,...23}
- 22 1970_06_NY_22 Equations and Expressions: Using Substitution in
The expression $x - 4$ has the same value as $3x - 10$ when
- (1) $3x - 10 = 0$
 - (2) $x + 3 = 0$
 - (3) $x = 3$
 - (4) $x = 3\frac{1}{2}$
- 23 1970_06_NY_23 Systems: Linear
Which ordered pair is in the solution of the following system of equations?
 $2x + 3y = 7$
 $x + y = 3$
- (1) (2,1)
 - (2) (1,2)
 - (3) 5,-1
 - (4) (0,3)
- 24 1970_06_NY_24 Quadratics: Solving by Factoring
The solution set for $x^2 + 7x + 12 = 0$ is
- (1) {1,6}
 - (2) {-1,-6}
 - (3) {3,4}
 - (4) {-3,-4}
- 25 1970_06_NY_25 Radicals: Operations with
The expression $\sqrt{125} - \sqrt{20}$ is equivalent to
- (1) $5\sqrt{3}$
 - (2) $3\sqrt{5}$
 - (3) $21\sqrt{5}$
 - (4) $\sqrt{105}$
- 26 1970_06_NY_26 Numbers: Properties of Real
A subset of the set of integers is the set of
- (1) rational numbers
 - (2) irrational numbers
 - (3) whole numbers
 - (4) real numbers
- 27 1970_06_NY_27 Notes and Interest
If the yearly income from a \$1,000 investment is \$30, the annual interest rate is
- (1) $33\frac{1}{3}\%$
 - (2) 30%
 - (3) 3%
 - (4) .3%
- 28 1970_06_NY_28 Points on a Line: Identification of
The coordinates of the point where the graph of $y = 2x - 1$ intersects the y -axis are
- (1) (0, -1)
 - (2) (-1, 0)
 - (3) $\left(\frac{1}{2}, 0\right)$
 - (4) $\left(0, \frac{1}{2}\right)$
- 29 1970_06_NY_29 Numbers: Properties of Real
Which is an illustration of the distributive property?
- (1) $a(b + c) = ab + ac$
 - (2) $ab = ba$
 - (3) $a + (b + c) = (a + b) + c$
 - (4) $a + b = b + a$

30 1970_06_NY_30 Inequalities: Linear

A graph of $2x \leq 6$ is

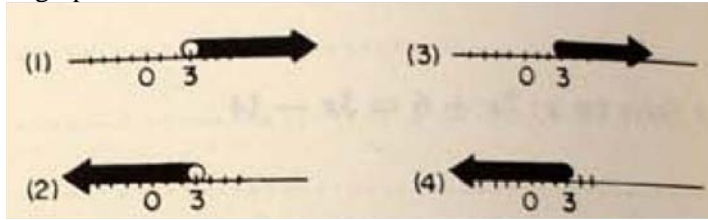

31 1970_06_NY_31a Inequalities: Graphing Systems of

Using a set of coordinate axes, graph the solution set of the following system of inequalities and label the solution set A: [8,2]

$$y \leq x - 3$$

$$y > -x + 1$$

32 1970_06_NY_31b Systems: Linear

Solve graphically and check: [8,2]

$$y = -x$$

$$2x - y = 3$$

33 1970_06_NY_32a Systems: Linear

Find algebraically the solution set of the following system of equations and check: [4,2]

$$\frac{x - y}{2} = 1$$

$$\frac{x + y}{2} = 4$$

34 1970_06_NY_32b Rationals: Addition and Subtraction of

Express as a single fraction in lowest terms: [4]

$$\frac{5y - 1}{2y} - \frac{5y + 2}{3y}$$

35 1970_06_NY_33 Equations and Expressions: Modeling

Find three consecutive positive integers such that the square of the smallest integer exceeds the largest integer by 10. [Only an algebraic solution will be accepted.] [5,5]

36 1970_06_NY_34 Equations and Expressions: Modeling

Write an equation or a system of equations which can be used to solve each of the following problems. In each case state what the variable or variables represent, [Solution of the equations is not required.]

- A man invested one-half of a certain sum of money at 6% and one-fifth of it at 5%. At the end of one year his income from these investments was \$200. What was the original sum of money? [5]
- At a sale of fur coats Mrs. Brown paid \$360 for a coat that had been reduced by 20% of the original price. What was the original price? [5]

37 1970_06_NY_35a Triangles: Pythagoras

The isosceles right triangle shown below has two equal sides each of which measures 10.

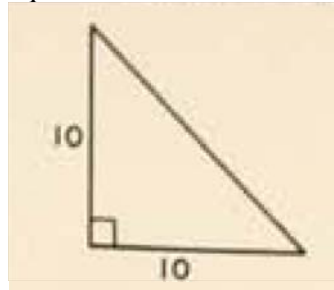

Find the length of the hypotenuse to the nearest integer. [5]

38 1970_06_NY_35b Trigonometry: Finding Sides

In right triangle ABC , $\angle A = 38^\circ$, $\angle C = 90^\circ$, and $BC = 10$. Find AC to the nearest integer.

- 39 1970_06_NY_36 Rate, Time and Distance
Mr. Smith drove his automobile at an average speed 15 miles per hour faster than Mr. Jones. Mr. Smith drove 225 miles in the same time that Mr. Jones drove 150 miles. Find the average speed in miles per hour at which Mr. Jones drove. [Only an algebraic solution will be accepted.] [5,5]

- 40 1970_06_NY_37 Sets: Replacement
The replacement set for x for each of the open sentences listed below is $\{-3, -2, -1, 0, 1, 2, 3\}$. On your answer paper, write the letters a through e , and next to each write the solution set of each open sentence. [Each answer must be a subset of the replacement set.]

- a. $5x + 2 < 2x + 5$ [2]
b. $x^2 = 9$ [1, 1]
c. $2x - 1 = 0$ [2]
d. $-1 < x \leq 1$ [1, 1]
e. $|x| = 2$ [1, 1]

- 41 1970_08_NY_01 Similarity: Right Triangles
A tree which is 60 feet tall casts a shadow of 12 feet. Under the same conditions how many feet tall is a tower that casts a shadow of 50 feet?

- 42 1970_08_NY_02 Equations and Expressions: Using Substitution in

If $b = -2$ and $c = 5$, evaluate $c(b^2 - 2)$.

- 43 1970_08_NY_03 Equations: Simple
Find the root of the equation $5x - 6 = 34$.

- 44 1970_08_NY_04 Rationals: Solving

Solve for n : $\frac{2n}{3} - 2 = 8$

- 45 1970_08_NY_05 Equations: Simple

Solve for x : $2(x + 5) = 8$

- 46 1970_08_NY_06 Quadratics: Solving by Factoring

The area of a rectangle is represented by $n^2 + 3n - 10$. If the length of the rectangle is $n + 5$, express the width in terms of n .

- 47 1970_08_NY_07 Absolute Value

Find the value of $|-8| + 2$.

- 48 1970_08_NY_08 Rate

It takes Tom x hours to paint his house. Express in terms of x the part of the job Tom completes in one hour.

- 49 1970_08_NY_09 Quadratics: Difference of Perfect Squares

Factor: $x^2 - 25$

- 50 1970_08_NY_10 Proportions

A line 28 inches in length is divided into two parts in the ratio 3:1. Find the number of inches in the length of the shorter segment.

- 51 1970_08_NY_11 Radicals: Square Roots

Find the positive square root of 17 to the nearest tenth.

- 52 1970_08_NY_12 Systems: Linear

Solve for y in the following system of equations:

$$x = y - 2$$

$$x = -2y + 4$$

- 53 1970_08_NY_13 Trigonometry: Finding Sides

In right triangle ABC below, $\angle C = 90^\circ$, $\angle A = 30^\circ$, and $AB = 20$.

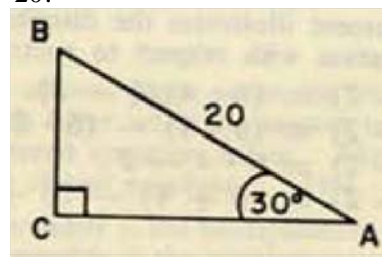

Find the length of side BC

- 54 1970_08_NY_14 Rationals: Addition and Subtraction of

Express $\frac{x}{5} + \frac{x+2}{3}$ as a single fraction.

- 55 1970_08_NY_15 Points on a Line: Identification of

The point whose coordinates are $(3, y)$ lies on the line whose equation is $2x + y = 10$. Find the value of y at that point.

- 56 1970_08_NY_16 Polynomials: Addition and Subtraction of
From $2x^2 - x + 7$ subtract $x^2 - 2x - 3$.
- 57 1970_08_NY_17 Equations: Literal
Solve for x in terms of a and b : $ax - b = 0$
- 58 1970_08_NY_18 Triangles: Pythagoras
The hypotenuse of a right triangle is 10 and one leg is 6. Find the length of the other leg of the triangle.
- 59 1970_08_NY_19 Set Theory
A set which is equal to $\{1,3,4,6\}$ is
(1) $\{2,5,7,9\}$
(2) $\{1,3,4\}$
(3) $\{6,4,1,3\}$
(4) $\{6,4,3\}$
- 60 1970_08_NY_20 Quadratics: Solving
The solution set of $(x + 5)(x - 3) = 0$ is
(1) $\left\{\frac{3}{5}\right\}$
(2) $\{2\}$
(3) $\{5, -3\}$
(4) $\{-5, 3\}$
- 61 1970_08_NY_21 Slope Intercept Form of a Line
An equation of a straight line whose y-intercept is 3 is
(1) $y = \frac{1}{2}x - \frac{3}{2}$
(2) $y = \frac{1}{2}x + \frac{3}{2}$
(3) $y = \frac{1}{2}x + 3$
(4) $y = \frac{1}{2}x - 3$
- 62 1970_08_NY_22 Polynomials: Multiplication and Division of
The fraction $\frac{2x-6}{2}$ is equivalent to
(1) $x - 6$
(2) $2x - 3$
(3) $2x - 4$
(4) $x - 3$
- 63 1970_08_NY_23 Numbers: Properties of Real
Which statement illustrates the distributive property of multiplication with respect to subtraction?
(1) $6(4 - 2) = (6 \cdot 4)(6 - 2)$
(2) $6(4 - 2) = (6 \cdot 4) - (6 \cdot 2)$
(3) $6(4 - 2) = (6 \cdot 4) - 2$
(4) $6(4 - 2) = (6 + 4) - (6 + 2)$
- 64 1970_08_NY_24 Inequalities: Linear
The solution set of $3x - 3 > 2x + 1$ is
(1) $\{x|x < 4\}$
(2) $\{x|x > -2\}$
(3) $\{x|x > 4\}$
(4) $\{x|x > -4\}$
- 65 1970_08_NY_25 Consecutive Integers
If a is an odd integer, which of the following is an odd integer?
(1) $a+1$
(2) $2a$
(3) $a+2$
(4) $a-1$
- 66 1970_08_NY_26 Polynomials: Multiplication and Division of
The quotient $(6x^6 - 9x^4 + 3x^2) \div (3x^2)$ is
(1) $2x^4 - 3x^2$
(2) $2x^3 - 3x^2$
(3) $2x^3 - 3x^2 + 1$
(4) $2x^4 - 3x^2 + 1$
- 67 1970_08_NY_27 Exponents: Operations with
An expression equivalent to $(3k^2)^3$ is
(1) $9k^6$
(2) $27k^6$
(3) $27k^5$
(4) $9k^5$

- 68 1970_08_NY_28 Radicals: Operations with
The expression $\sqrt{75} - \sqrt{48}$ is equivalent to
 (1) 1
 (2) $\sqrt{3}$
 (3) $3\sqrt{3}$
 (4) $9\sqrt{3}$

- 69 1970_08_NY_29 Equations and Expressions: Modeling
An item which normally sells for d dollars is on sale at a 10% discount. The new price in dollars is
 (1) $.10d$
 (2) $.90d$
 (3) $1.10d$
 (4) $.09d$

- 70 1970_08_NY_30 Inequalities: Linear
The figure at the right shows the graph of

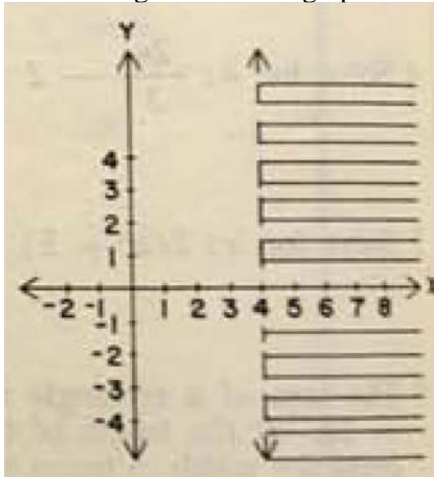

- (1) $x > 4$
 (2) $x \geq 4$
 (3) $y > 4$
 (4) $y \geq 4$

- 71 1970_08_NY_31a Systems: Linear
Solve graphically and check: [8,2]
 $x - y = 2$
 $x + 2y = 11$

- 72 1970_08_NY_32 Systems: Linear
Solve the system of equations for x and y and check in both equations: [8,2]

$$\frac{x-2}{3} + \frac{12-y}{4} = 2$$

$$2x - y = 4$$

- 73 1970_08_NY_33 Systems: Writing
A postal clerk sold 25 postal stamps for \$1.66. Some were 6-cent stamps and some were 10-cent stamps. Find the number of each sold. [Only an algebraic solution will be accepted.] [5,5]

- 74 1970_08_NY_34 Systems: Writing
Write an equation or a system of equations which can be used to solve each of the following problems. In each case state what the variable or variables represent, [Solution of the equations is not required.]

- a. A man made a trip of 280 miles, stopping once for lunch. In the morning he averaged 50 miles per hour and in the afternoon 40 miles per hour. The morning part of the trip was 3 hours longer than the afternoon part. How long did he travel before he stopped for lunch? [5]
- b. Six years ago in a state park the deer outnumbered the foxes by 80. Since then the number of deer has doubled and the number of foxes has increased by 20. If there is now a total of 240 deer and foxes in the park, how many foxes were there six years ago? [5]

75 1970_08_NY_35 Trigonometry: Finding Angles

Answer both a and b:

- a. In the diagram below, EF represents a lighthouse 120 feet high. From the top of the lighthouse the angle of depression of a boat at D is 29° .

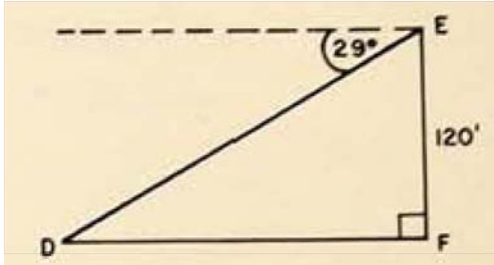

Find, to the nearest foot, the distance DF from the boat to the base of the lighthouse. [6]

- b. In right triangle ABC , the hypotenuse AB is 8 and leg BC is 3. Find angle A to the nearest degree. [4]

76 1970_08_NY_36 Equations and Expressions: Modeling

The length of a rectangle is 3 more than its width. If the length is decreased by 1 and the width is increased by 1, the area of the new rectangle will be 20. Find the width of the original rectangle. [Only an algebraic solution will be accepted.] [5,5]

77 1970_08_NY_37 Numbers: Properties of Real

On your answer paper write the letter a through e. After each letter write the answer to the correspondingly lettered question below. The replacement set is the set of real numbers. [10]

- What number is the multiplicative identity element?
- What number is the multiplicative inverse of $-\frac{3}{2}$?
- What number has no multiplicative inverse?
- What is the additive inverse of 2?
- Write a number which is equal to its multiplicative inverse.

78 1980_01_NY_01 Rationals: Solving

Solve for x : $\frac{3}{5} = \frac{9}{x}$

79 1980_01_NY_02 Equations: Simple

Solve for x : $3(2x - 1) = 21$

80 1980_01_NY_03 Polynomials: Multiplication and Division of

Express as a trinomial: $(2x + 3)(x - 4)$

81 1980_01_NY_04 Polynomials: Addition and Subtraction of

What is the sum of $3a + 4b - 6c$ and $2a - 4b + 2c$?

82 1980_01_NY_05 Equations: Simple with Decimals

Solve for x : $x - 0.1 = 1.6$

83 1980_01_NY_06 Quadratics: Difference of Perfect Squares

Factor: $4x^2 - 25$

84 1980_01_NY_07 Polynomials: Factoring

Factor: $x^2 - 2x - 8$

85 1980_01_NY_08 Perimeter

If the sides of a triangle are represented by $2x$, $x + 5$, and $3x - 6$, express the perimeter of the triangle in terms of x .

86 1980_01_NY_09 Similarity

In the accompanying diagram of triangles ABC and DGF , $\angle A = \angle D$ and $\angle B = \angle G$. If $AC = 3$, $AB = 4$, and $DF = 9$, what is the length of DG ?

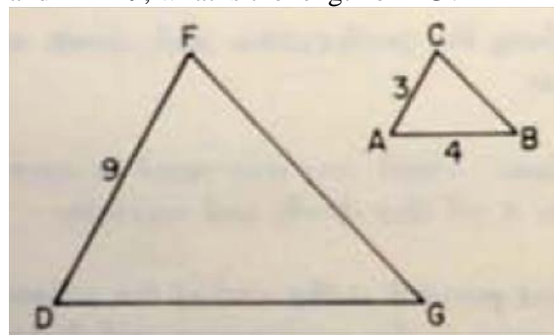

87 1980_01_NY_10 Equations and Expressions: Modeling

If Sally's weekly allowance is t dollars, express in dollars her allowance for c weeks in terms of t and c .

88 1980_01_NY_11 Sets: Replacement

If the replacement set for x is $\{-3, -1, 0, 1, 3\}$, write the members of the solution set for $3x < 0$.

- 89 1980_01_NY_12 Systems: Linear
Solve the following system of equations for x :
 $3x + y = 5$
 $2x - y = 5$
- 90 1980_01_NY_13 Equations: Literal
Solve for x in terms of a , b , and c .
 $ax + b = c$
- 91 1980_01_NY_14 Complementary, Supplementary and Vertical Angles
If two angles of a triangle are complementary; how many degrees are there in the third angle?
- 92 1980_01_NY_15 Radicals: Square Roots
Find the value of $\sqrt{40}$ to the *nearest tenth*.
- 93 1980_01_NY_16 Equations and Expressions: Using Substitution in
If $x = -3$, and $y = 2$, find the value of $(xy)^2$.
- 94 1980_01_NY_17 Central Tendency: Averages
Express the average of $x + 1$ and $3x - 3$ as a binomial.
- 95 1980_01_NY_18 Rationals: Addition and Subtraction of
Express as a single fraction:
 $\frac{3x}{2} + \frac{4x}{3}$
- 96 1980_01_NY_19 Exponents: Operations with
The product of xy^2 and x^2y^2 is
(1) x^2y^5
(2) x^2y^6
(3) x^3y^5
(4) x^3y^6
- 97 1980_01_NY_20 Exponents: Operations with
When $-15x^6$ is divided by $-5x^3$, the quotient is
(1) $3x^2$
(2) $-3x^2$
(3) $3x^3$
(4) $-3x^3$
- 98 1980_01_NY_21 Numbers: Properties of Real
The multiplicative inverse of $-\frac{1}{3}$ is
(1) $\frac{1}{3}$
(2) -3
(3) 3
(4) $.33\frac{1}{3}$
- 99 1980_01_NY_22 Numbers: Properties of Real
Which must be added to $2x - 4$ to produce a sum of 0 ?
(1) 0
(2) $x + 2$
(3) $2x + 4$
(4) $-2x + 4$
- 100 1980_01_NY_23 Points on a Line: Identification of
Which pair of numbers represents a point that does *not* lie on the graph of $2x + 3y = 6$?
(1) $(0, 2)$
(2) $(2, 3)$
(3) $(3, 0)$
(4) $(6, -2)$
- 101 1980_01_NY_24 Set Theory
If set $A = \{1, 3, 5, 7, 9\}$ and set $B = \{3, 4, 5\}$, then a subset of B that is also a subset of A is
(1) $\{ \}$
(2) $\{1, 3, 5\}$
(3) $\{5, 7\}$
(4) $\{4\}$
- 102 1980_01_NY_25 Quadratics: Solving by Factoring
A root of the equation $x^2 - 13x - 48 = 0$ is
(1) 8
(2) 2
(3) 12
(4) 16

103 1980_01_NY_26 Radicals: Simplifying
The expression $\sqrt{90}$ is equivalent to

- (1) $6\sqrt{15}$
- (2) $9\sqrt{10}$
- (3) $3\sqrt{10}$
- (4) $10\sqrt{3}$

104 1980_01_NY_27 Inequalities: Linear
Which solution set is represented by the graph below?

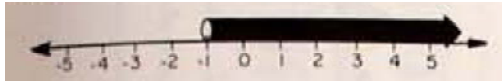

- (1) $\{x|x > -1\}$
- (2) $\{x|x < -1\}$
- (3) $\{x|x \leq -1\}$
- (4) $\{x|x \geq -1\}$

105 1980_01_NY_28 Absolute Value
The value of $|-8| + |-3|$ is

- (1) 5
- (2) 16.4
- (3) 16.5
- (4) 17

106 1980_01_NY_29 Estimation and Rounding
What is 16.47 rounded to the nearest integer?

- (1) 16
- (2) 16.4
- (3) 16.5
- (4) 17

107 1980_01_NY_30 Conversions
The number of inches in $(3x - 2)$ feet is

- (1) $12x$
- (2) $\frac{3x - 2}{12}$
- (3) $36x - 2$
- (4) $36x - 24$

108 1980_01_NY_31 Inequalities: Graphing Systems of
On the same set of coordinate axes, graph the following system of inequalities and label the set A. [8, 2]

$$2x - y \leq 3$$
$$3x + y < 7$$

109 1980_01_NY_32a Systems: Writing
Two positive numbers are in the ratio of 5 to 13. If the difference between the two numbers is 48, find the larger number. [5]

110 1980_01_NY_32b Rationals: Addition and Subtraction of
Express as a single fraction in lowest terms:

$$\frac{2x + 1}{8} - \frac{x + 2}{6} \quad [5]$$

111 1980_01_NY_33 Systems: Linear
Solve the following system of equations algebraically and check.

$$\frac{y}{2} = x + 1 \quad [8, 2]$$

$$4x - y = 6$$

112 1980_01_NY_34 Systems: Writing
The cost of a high school ring was \$45 for the large size and \$35 for the regular size. The total receipts from the sale of 120 rings were \$5,000. How many rings of each size were sold? [Only an algebraic solution will be accepted.] [5, 5]

113 1980_01_NY_35 Quadratics: Writing
The sides of a rectangle are x and $x + 6$. The area of the rectangle is 55. Find the lengths of the sides. [Only an algebraic solution will be accepted.] [5, 5]

- 114 1980_01_NY_36a Trigonometry: Finding Angles
As indicated in the accompanying diagram, a vertical flagpole 50 meters tall casts a shadow 75 meters long on level ground. What is the angle of elevation of the Sun to the *nearest degree*? [5]

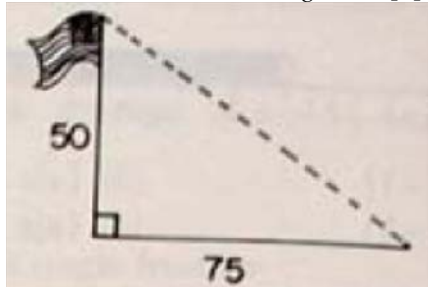

- 115 1980_01_NY_36b Trigonometry: Finding Sides
As shown in the accompanying diagram, a kite is flying at the end of a 200-meter straight string. If the string makes an angle of 68° with the ground, how high is the kite to the *nearest meter*? [5]

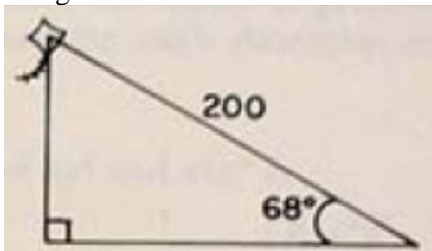

- 116 1980_01_NY_37 Numbers: Properties of Real
Each of the questions in a through e can be correctly answered by ONE and ONLY ONE of the following numbers: -2, -1, 0, 1, 2. On your answer paper, write the letters *a* through *e* and after each letter, write the number which answers the question. [10]
- What is the smallest natural number?
 - What is the additive identity element?
 - What number satisfies the inequality $2x > 3$?
 - What is the largest negative number?

For what value of y is the fraction $\frac{6}{y+2}$ meaningless?

- 117 1980_06_NY_01 Equations: Simple
Solve for x : $3x - 5 = 16$

- 118 1980_06_NY_02 Absolute Value
Find the value of $|-4| - |8|$.

- 119 1980_06_NY_03 Triangles: Pythagoras
The length of a rectangle is 8 centimeters and its width is 6 centimeters. Find the number of centimeters in the length of the diagonal.

- 120 1980_06_NY_04 Special Quadrilaterals: Rectangles and Squares
The perimeter of a square is represented by $8x - 12$. Express length of one side of the square in terms of x .

- 121 1980_06_NY_05 Conversions
Express $\frac{5}{7}$ as a decimal, rounded to the *nearest hundredth*.

- 122 1980_06_NY_06 Equations and Expressions: Using Substitution in
Find the numerical value of the expression $c + xy$ when $c = 3$, $x = 4$, and $y = -5$.

- 123 1980_06_NY_07 Radicals: Operations with
Combine into a single term: $3\sqrt{12} + 2\sqrt{3}$

- 124 1980_06_NY_08 Polynomials: Multiplication and Division of
Express the product of $(a - b)$ and $(a + b)$ as a binomial.

- 125 1980_06_NY_09 Equations: Simple with Decimals
Solve for x : $0.2x + 0.3 = 8.1$

- 126 1980_06_NY_10 Equations: Simple with Fractional Expressions
Solve for c : $\frac{1}{3}c + 2 = 4$

- 127 1980_06_NY_11 Radicals: Square Roots
Find $\sqrt{42}$ to the *nearest tenth*.

- 128 1980_06_NY_12 Percent
If 60% of a number is 144, what is the number?

- 129 1980_06_NY_13 Polynomials: Factoring
Factor: $x^2 - 10x - 56$

130 1980_06_NY_14 Quadratics: Difference of Perfect Squares
Solve for the positive value of x : $x^2 - 81 = 0$

131 1980_06_NY_15 Equations: Literal
Solve for x in terms of a and b : $3x - b = a$

132 1980_06_NY_16 Similarity: Right Triangles
A vertical flagpole casts a shadow 16 meters long at the same time that a nearby tree 5 meters in height casts a shadow 4 meters long. What is the number of meters in the height of the flagpole?

133 1980_06_NY_17 Systems: Linear
Solve the following system of equations for y :
 $3x + 2y = 7$
 $-3x + y = 8$

134 1980_06_NY_18 Trigonometric Ratios: Basic
In the accompanying figure, $AC = 4$, $BC = 3$, and $AB = 5$. Express as a single fraction: $\sin A + \cos A$

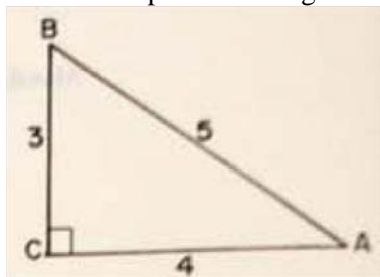

135 1980_06_NY_19 Numbers: Properties of Real
The sum of two polynomials is zero. If one of the polynomials is $3x^2 + 5x - 7$, what is the other polynomial?

136 1980_06_NY_20 Exponents: Operations with
The expression $\frac{-12x^6y^2}{3x^2y}$ is equivalent to

- (1) $9x^3y^2$
- (2) $4x^4y$
- (3) $-4x^3y$
- (4) $-4x^4y$

137 1980_06_NY_21 Polynomials: Multiplication and Division of
When $12x^3 + 8x^2 - 4x$ is divided by $4x$, the quotient is

- (1) $3x^3 + 2x^2 - 1x$
- (2) $3x^2 + 2x - 1x$
- (3) $3x^2 - 2x - 1x$
- (4) $3x^2 + 2x$

138 1980_06_NY_22 Complementary, Supplementary and Vertical Angles
Two complementary angles are in the ratio 4:5. What is the measure in degrees of the smaller angle?

- (1) 10
- (2) 40
- (3) 50
- (4) 80

139 1980_06_NY_23 Polynomials: Multiplication and Division of
The expression $-6x - 7(4 + 3x)$ is equivalent to

- (1) $-3x - 28$
- (2) $-21x - 4$
- (3) $-27x - 28$
- (4) $-9x - 28$

140 1980_06_NY_24 Rationals: Addition and Subtraction of
The expression $\frac{x}{3} + \frac{x}{5}$ is equivalent to

- (1) $\frac{8}{15}$
- (2) $\frac{8x}{15}$
- (3) $\frac{2x}{15}$
- (4) $\frac{2x}{8}$

141 1980_06_NY_25 Factors: Greatest Common
The greatest common factor of the numbers 16, 20, and 40 is

- (1) 320
- (2) 2
- (3) 40
- (4) 4

- 142 1980_06_NY_26 Graphs: Identifying Equations of
The graph of which equation is shown in the accompanying diagram?

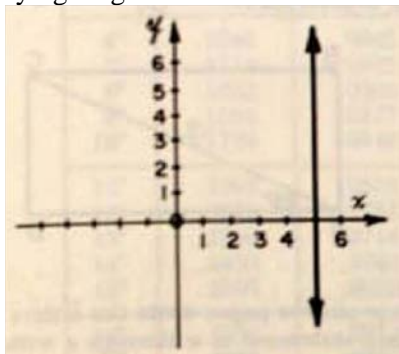

- (1) $x = 5$
 (2) $y = 5$
 (3) $y = 5x$
 (4) $y = x + 5$
- 143 1980_06_NY_27 Consecutive Integers
If $n + 1$ represents an even integer, which expression also represents an even integer?
 (1) n
 (2) $n + 2$
 (3) $n + 3$
 (4) $n - 2$
- 144 1980_06_NY_28 Sets: Replacement
Which ordered pair is in the solution set of $x < 6 - y$?
 (1) $(0, 6)$
 (2) $(6, 0)$
 (3) $(0, 5)$
 (4) $(7, 0)$
- 145 1980_06_NY_29 Numbers: Properties of Real
If a and b are natural numbers, which expression must represent a natural number?
 (1) $a - b$
 (2) $a + b$
 (3) $\frac{a}{b}$
 (4) $b \div a$

- 146 1980_06_NY_30 Numbers: Properties of Real
Which statement is true for the set of whole numbers $(0, 1, 2, 3, \text{etc.})$?
 (1) The multiplicative identity element is 0.
 (2) The additive identity element is 1.
 (3) Some elements of the set are irrational.
 (4) The set has the closure property under addition.
- 147 1980_06_NY_31 Systems: Linear
Solve graphically and check:
 $2y = x + 6$ [8,2]
 $y = 3x - 2$
- 148 1980_06_NY_32a Rationals: Solving
Solve for y and check:
 $\frac{y-3}{6} + \frac{y-25}{5} = 0$ [4,1]
- 149 1980_06_NY_32b Polynomials: Multiplication and Division of
From the product of $(2x - 1)$ and $(x + 3)$, subtract $x^2 + 4x + 2$. [5]
- 150 1980_06_NY_33 Systems: Writing
Write an equation or system of equations that can be used to solve *each* of the following problems. In *each* case state what the variable or variables represent. [Solution of the equations is not required.]
 a. The tens digit of a two-digit number exceeds twice the units digit by one. If seven is added to the number, the result is equal to eight times the sum of the digits. Find the number. [5]
 b. Two cars are 210 miles apart. They leave at the same time, traveling toward each other, and meet in 3 hours. If the rate of one car is ten miles an hour more than that of the other, what is the rate of the slower car? [5]
- 151 1980_06_NY_34 Systems: Writing
The cost of a high school textbook was \$5 if purchased before June and \$7 thereafter. The total receipts from the sale of 150 books was \$810. How many books were purchased at each price? [Only an algebraic solution will be accepted.] [5,5]

152 1980_06_NY_35 Quadratics: Writing
The square of a positive number is 42 more than the number itself. What is the number? [5,5]

153 1980_06_NY_36a Trigonometry: Finding Angles
In right triangle ABC , the hypotenuse AB is 11 and leg BC is 4, Find the measure of angle A to the nearest degree. [5]

154 1980_06_NY_36b Trigonometry: Finding Sides
As shown in the accompanying figure, the diagonal of rectangle $ABCD$ is 12 meters and makes an angle of 25° with \overline{AD} . Find the length of \overline{AD} to the nearest meter. [5]

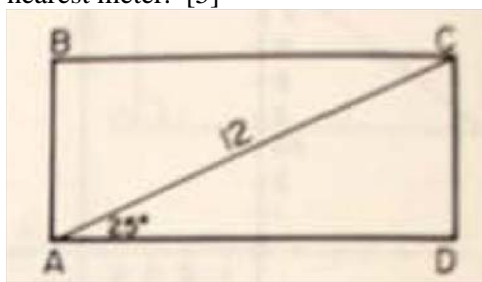

155 1980_06_NY_37 Numbers: Properties of Real
On your paper write the letters a through e . For each statement in a through e write the number of the property of the real number system, *chosen from the list below*, which justifies the statement. [10]

Properties

- (1) Additive inverse property
- (2) Multiplicative identity property
- (3) Commutative property of addition
- (4) Commutative property of multiplication
- (5) Associative property of addition
- (6) Associative property of multiplication
- (7) Distributive property of multiplication over addition

- a. $7 + (3 + 2) = (7 + 3) + 2$
- b. $(-5)(1) = -5$
- c. $3(x + 2) = 3x + 6$
- d. $4 + (-4) = 0$
- e. $7(8) = 8(7)$

156 1980_08_NY_01 Equations: Simple
Solve for y : $3y + 6 = y - 2$

157 1980_08_NY_02 Equations: Simple with Decimals
Solve for x : $.08x = 3.2$

158 1980_08_NY_03 Absolute Value
Find the value of $\frac{|-7|}{7} + |5|$

159 1980_08_NY_04 Estimation and Rounding
How many significant digits are there in 63.2?

160 1980_08_NY_05 Equations and Expressions: Using Substitution in
If $x = -2$ and $y = 3$, find the value of the expression $5x^2y$.

161 1980_08_NY_06 Rationals: Solving
Solve for x : $\frac{2x}{3} - 6 = 2$

162 1980_08_NY_07 Percent
In a class of 400 freshmen, 80 percent study algebra. How many freshmen study algebra?

163 1980_08_NY_08 Proportion
Sheila can mow a lawn in 3 hours. At this rate, what part of the lawn can she mow in one hour?

164 1980_08_NY_09 Equations: Literal
Solve for s in terms of p : $4s = p$

165 1980_08_NY_10 Rationals: Addition and Subtraction of
Express $\frac{2x}{3} - \frac{x}{5}$ as a single fraction.

166 1980_08_NY_11 Quadratics: Difference of Perfect Squares
Factor: $a^2 - 81$

167 1980_08_NY_12 Proportions
If 6 grams of a certain metal costs \$8, what will be the cost of 15 grams of the metal?

168 1980_08_NY_13 Quadratics: Solving
One root of the equation $(x - 2)(x + 3) = 0$ is -3 . Find the other root.

- 169 1980_08_NY_14 Equations: Simple
Solve for x : $3x + 2(x + 2) = 14$
- 170 1980_08_NY_15 Radicals: Square Roots
Find the value of $\sqrt{28}$ to the *nearest tenth*.
- 171 1980_08_NY_16 Systems: Writing
Two numbers are in the ratio of 1:4 and their sum is 55. Find the *smaller* of the two numbers.
- 172 1980_08_NY_17 Triangles: Interior and Exterior Angles of
The measure of one acute angle of a right triangle is 32° . Find the number of degrees in the other acute angle.
- 173 1980_08_NY_18 Trigonometric Functions: Inverses of
Find, to the nearest degree, the measure of the angle whose cosine is .8510.
- 174 1980_08_NY_19 Factors: Greatest Common
Find the greatest common factor of $3x^3 + 6x$.
- 175 1980_08_NY_20 Triangles: Equilateral
The length of a side of an equilateral triangle is represented by $3x - y$. Express the perimeter of the triangle in terms of x and y .
- 176 1980_08_NY_21 Sets: Replacement
If the replacement set for x is $\{1, 2, 3, 4\}$, what is the solution set of the inequality $4x - 3 < 2$?
- 177 1980_08_NY_22 Systems: Linear
Solve the following system of equations for y :
 $7x + 3y = 3$
 $-7x + y = 1$
- 178 1980_08_NY_23 Polynomials: Multiplication and Division of
The expression $(x + 3)^2$ is equivalent to
(1) $x^2 + 9$
(2) $x^2 + 3x + 9$
(3) $x^2 + 6x + 9$
(4) $x^2 + 9x + 9$
- 179 1980_08_NY_24 Radicals: Operations with
The expression $\sqrt{12} + 3\sqrt{3}$ is equivalent to
(1) $7\sqrt{3}$
(2) $5\sqrt{3}$
(3) $3\sqrt{15}$
(4) $4\sqrt{15}$
- 180 1980_08_NY_25 Points on a Line: Identification of
The point where the graph of $y = x + 5$ intercepts the y -axis is
(1) (0,5)
(2) (5,0)
(3) (-5,0)
(4) (1,0)
- 181 1980_08_NY_26 Locus
Where does the point (-4,3) lie on the coordinate plane?
(1) on the x -axis
(2) on the y -axis
(3) above the x -axis
(4) below the x -axis
- 182 1980_08_NY_27 Numbers: Properties of Real
Which statement illustrates the associative property for multiplication?
(1) $9 \times 0 = 0$
(2) $\frac{1}{2} \times \frac{1}{4} = \frac{1}{4} \times \frac{1}{2}$
(3) $5 \times (3 \times 2) = (5 \times 3) \times 2$
(4) $5 \times \frac{1}{5} = 1$
- 183 1980_08_NY_28 Numbers: Properties of Real
The reciprocal of $3\frac{1}{7}$ is
(1) 7
(2) $\frac{7}{22}$
(3) $\frac{1}{3}$
(4) $-3\frac{1}{7}$

184 1980_08_NY_29 Set Theory

Which is a finite set?

- (1) $\{x|x \text{ is an even number}\}$
- (2) $\{x|x \text{ is a number greater than } 1\}$
- (3) $\{x|x \text{ is an integer less than } 100\}$
- (4) $\{x|x \text{ is the number of people in the United States}\}$

185 1980_08_NY_30 Rationals: Undefined

For which value of x is the expression $\frac{6}{x-4}$ undefined or meaningless?

- (1) -6
- (2) -4
- (3) 0
- (4) 4

186 1980_08_NY_31 Systems: Linear

Solve graphically and check:

$$y = 2x - 4 \quad [8,2]$$

$$x + 2y = 7$$

187 1980_08_NY_32a Quadratics: Solving by Factoring

Find the roots of the equation:

$$x^2 = 4 - 3x \quad [5]$$

188 1980_08_NY_32b Polynomials: Multiplication and Division of

Express the indicated product as a single fraction in

lowest terms: $\frac{a^2 - 25}{a^2 + 8a + 15} \cdot \frac{a + 3}{a^2 - 5a} \quad [5]$

189 1980_08_NY_33 Systems: Writing

Write an equation or system of equations that can be used to solve *each* of the following problems. In *each* case state what the variable or variables represent. [Solution of the equations is not required.]

- a. A man invested \$1,000 more than his wife. The annual income from both investments at 6% was \$300. How much did they each invest? [5]
- b. The denominator of a fraction is 7 more than its numerator. If the numerator is increased by 3 and the denominator is decreased by 2, the new fraction equals $\frac{4}{5}$. Find the original fraction. [5]

190 1980_08_NY_34 Systems: Writing Quadratic

The width of a rectangle is 1 less than the side of a square, and the length of the rectangle is 2 more than the side of a square. The area of the rectangle is 4 more than the area of the square. Find the length of a side of the square. [Only an algebraic solution will be accepted.] [5,5]

191 1980_08_NY_35 Systems: Writing

Mike has 2 more dimes than quarters and 7 more nickels than quarters. The total value of the coins is \$1.75. How many quarters does he have? [Only an algebraic solution will be accepted.] [5,5]

192 1980_08_NY_36a Trigonometry: Finding Sides

In the accompanying figure $ABCD$ is a rectangle. If $AC = 15\text{cm}$ and angle CAB contains 41° , find the length of AB correct to the nearest centimeter. [5]

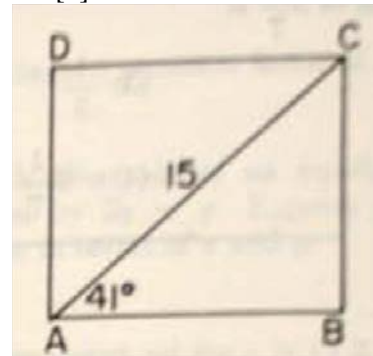

193 1980_08_NY_36b Trigonometry: Finding Angles

As shown in the accompanying figure, a flagpole 10 meters high casts a shadow 12 meters long on level ground. Find, to the *nearest degree*, the measure of the angle of elevation of the Sun (angle E). [5]

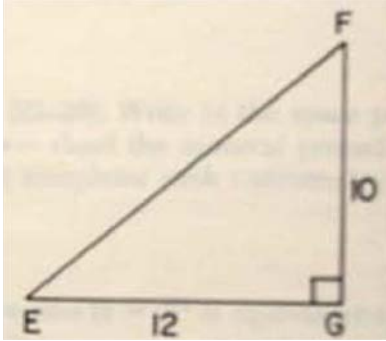

194 1980_08_NY_37 Sets: Replacement

The replacement set of x for each open sentence below is $\{-2, -1, 0, 1, 2\}$. On your answer page write the letters a through e , and next to each write the solution set of each open sentence. [Each answer must be a subset of the replacement set.]

- $2x + 1 < x + 1$
- $3x = 1$
- $4 - x^2 = 0$
- $|x| = 1$
- $2 - \frac{x}{2} = 1$

PG - The Plane Geometry Curriculum (1890-1930)

- 1 1890_01_PG_01 Definitions: Geometry
Define and illustrate by a figure each of the following: alternate angles; tangent; secant; circle; circumference; altitude; similar polygons.
- 2 1890_01_PG_02 Definitions: Geometry
Define theorem, problem.
- 3 1890_01_PG_03 Definitions: Geometry
Mention four kinds of triangles named from the angles they contain.
- 4 1890_01_PG_04 Proofs: Triangle
Prove that if two triangles have a side and the two adjacent angles of the one equal to a side, and the two adjacent angles of the other, each to each, the triangles will be equal in all their parts.
- 5 1890_01_PG_05 Proofs: Circle
Prove that two parallels intercept equal arcs of a circumference (three cases).
- 6 1890_01_PG_06 Proofs: Pythagorus
Prove that the square described on the hypotenuse of a right-angled triangle is equal to the sum of the squares described on the other two sides.
- 7 1890_01_PG_07 Proofs: Triangle
Prove that triangles which are mutually equiangular are similar.
- 8 1890_01_PG_08 Proofs: Circle
Prove the circumferences of circles are to each other as their radii, and the areas are to each other as the squares of their radii.
- 9 1890_01_PG_09 Constructions
Make the following constructions and show that each construction meets the conditions required:
 - a. To circumscribe a circle about a given triangle
 - b. To construct a triangle equivalent to a given polygon
 - c. To trisect a right angle
 - d. Through a given point without a circle to draw a tangent to the circle
- 10 1890_01_PG_10 Circles: Center, Radius and Circumference
Find the circumference of a circle the side of whose inscribed square is six feet.
- 11 1890_03_PG_a_01 Definitions: Geometry
Define and illustrate by a figure each of the following: angle; perpendicular lines; parallel lines; altitude of a triangle; trapezium; arc of a circle; diameter of a circle; similar polygons, hypothesis.
- 12 1890_03_PG_a_02 Proofs: Triangle
State three cases in which two triangles may be proven equal in all respects.
- 13 1890_03_PG_a_03 Proofs: Circle
Prove that a straight line perpendicular to a radius at its extremity is a tangent to the circle.
- 14 1890_03_PG_a_04 Triangles: Mean Proportionals
Prove that if in a right triangle a perpendicular be drawn from the vertex of the right angle to the hypotenuse, the perpendicular is a mean proportional between the segments of the hypotenuse.
- 15 1890_03_PG_a_05 Proofs: Polygon
Prove that the area of a parallelogram is equal to the product of its base and altitude.
- 16 1890_03_PG_a_06 Proofs: Polygon
Prove that the area of a regular polygon is equal to one-half the product of its apothem by its perimeter.

- 17 1890_03_PG_a_07 Constructions
Make the following constructions and show that each construction meets the conditions required:
a. To find a fourth proportional to the three given straight lines.
b. To construct a square equivalent to the difference of two given squares.
c. To inscribe in a circle a regular hexagon.
- 18 1890_03_PG_a_08 Proofs: Polygon
Given that every line drawn through the centre of a parallelogram is bisected by the centre, prove that any such line divides the perimeter into two equal parts.
- 19 1890_03_PG_a_09 Circles: Center, Radius and Circumference
If a carriage wheel makes 220 revolutions in traveling half a mile, find its diameter.
- 20 1890_03_PG_b_01 Definitions: Geometry
Define angle; parallel lines; proposition; demonstration; curved lines; perimeter; incommensurable ratio.
- 21 1890_03_PG_b_02 Proofs: Triangle
State two theorems directly involved in proving that if two triangles have three sides of the one equal respectively to three sides of the other, they are equal in all their parts.
- 22 1890_03_PG_b_03 Proofs: Polygon
Prove that diagonals of a parallelogram bisect each other.
- 23 1890_03_PG_b_04 Proofs: Triangle
Prove that similar triangles are to each other as the squares of the homologous sides.
- 24 1890_03_PG_b_05 Proofs: Triangle
Prove that the line joining the middle points of the sides of a triangle is parallel to the base.
- 25 1890_03_PG_b_06 Proofs: Circle
Prove that when two chords intersect in a circle the angle thus formed is measured by one-half the sum of the intercepted arcs.
- 26 1890_03_PG_b_07 Constructions
Make the following constructions and show that each construction meets the conditions required:
a. Give a base line, to construct upon it an equilateral triangle.
b. Given a circle to find its centre.
c. To inscribe a circle in a given circle.
- 27 1890_03_PG_b_08 Polygons: Area of
Give formulas for finding the following measurements: area of a regular polygon; circumference of a circle; area of a circle; area of a trapezoid.
- 28 1890_03_PG_b_09 Circles: Center, Radius and Circumference
Give the ratio of the circumference to the area of a circle whose radius is unity.
- 29 1890_03_PG_b_10 Circles: Center, Radius and Circumference
What is the width of the ring between two concentric circumferences whose lengths are 400 feet and 330 feet.
- 30 1890_03_PG_b_11 Circles: Chords
In a circle whose diameter is 20 feet the middle of a chord 8 feet long is how far from the center?
- 31 1890_06_PG_01 Definitions: Geometry
Define and illustrate perpendicular lines; polygon, rhomboid; arc; scalene triangle.
- 32 1890_06_PG_02 Parallel and Perpendicular Lines
State two theorems regarding the relation of angles formed by two parallel straight lines cut by a third straight line.
- 33 1890_06_PG_03 Proofs: Triangle
Prove that two triangles are equal in all respects when three sides of the one are equal respectively to three sides of the other.
- 34 1890_06_PG_04 Proofs: Polygon
Prove that rectangles having equal altitudes are to each other as their bases. (two cases).

- 35 1890_06_PG_05 Proofs: Triangle
Prove that two triangles which have an angle of the one equal to an angle of the other are to each other as the products of the sides about the equal angles.
- 36 1890_06_PG_06 Proofs: Circle
Prove that when two secants intersect without a circle, the angle formed is measured by one-half the difference of the intercepted arcs.
- 37 1890_06_PG_07 Polygons and Circles: Inscribed
Give brief but sufficient directions for inscribing in a circle (a) a square; (b) a regular hexagon.
- 38 1890_06_PG_08 Constructions
Show how the following constructions are made and that each construction meets the conditions required:
a. To construct a square equal to double a given square.
b. To divide the center of a given circle.
c. To divide a line into any number of equal parts.
- 39 1890_06_PG_09 Polygons: Area of
The bases of a trapezoid are 32 feet and 20 feet. Each of the other sides is equal to 10 feet. Find the area of the trapezoid.
- 40 1890_06_PG_10 Polygons: Area of
A rhombus and a square have equal perimeters; which has the greater area? What is the ratio of their areas if the altitude of the rhombus is one-half that of the square?
- 41 1900_01_PG_01 Definitions: Geometry
Define five of the following: *angle*, *axiom*, *scholium*, *trapezium*, *perimeter*, *tangent*, *antecedent*.
- 42 1900_01_PG_02 Complementary, Supplementary and Vertical Angles
Two angles whose sides are parallel each to each are either equal or supplementary. Give proof for both cases.
- 43 1900_01_PG_03 Proofs: Triangle
Prove that if two sides of a triangle are unequal the angles opposite are unequal and the greater angle is opposite the greater side.
- 44 1900_01_PG_04 Proofs: Circle
Prove that the angle formed by two chords intersecting within the circumference is measured by one half the sum of the intercepted arcs.
- 45 1900_01_PG_05 Proofs: triangle
Prove that the homologous altitudes of two similar triangles have the same ratio as any two homologous sides.
- 46 1900_01_PG_06 Polygons: Area of
Find the area of a rhombus whose longer diagonal is 30 inches and whose perimeter is 68 inches.
- 47 1900_01_PG_07 Circles: Chords, Secants and Tangents
Find the number of degrees in the angle formed by two secants which meet without the circle and intercept arcs of $\frac{4}{5}$ and $\frac{2}{15}$ of the circumference.
- 48 1900_01_PG_08_09 Circles: Area of
Find the area contained between three equal circles each of which is tangent externally to the other two and whose common radius is 2 inches.
- 49 1900_01_PG_10 Circles: Chords
The altitude of the segment of a circle is 9 inches and the length of the chord that subtends the segment is 30 inches; find the diameter of the circle.
- 50 1900_01_PG_11 Constructions
Show how to draw a tangent to a given circle through a given point a) on the circumference, b) without the circumference.
- 51 1900_01_PG_12 Constructions
Show how to inscribe a square in a given circle. Give proof.

- 52 1900_01_PG_13 Proofs: Polygon
Prove that if two adjacent sides of a quadrilateral are equal and the other two sides are equal the diagonals of the quadrilateral intersect at right angles.
- 53 1900_01_PG_14 Constructions
Show how to construct a circle passing through a given point and tangent to a given circle at a given point.
- 54 1900_01_PG_15 Proofs: Circle
Two tangents are drawn to a circle from a point without; prove that the triangle formed by these tangents and a tangent to the arc included by them has a perimeter equal to the sum of the first two tangents.
- 55 1900_03_PG_01 Proof: Geometry
Prove that if two parallel lines are cut by a third line the alternate interior angles are equal.
- 56 1900_03_PG_02 Proofs: Triangle
Prove that two triangles are equal if the three sides of one are equal to the three sides of the other, each to each.
- 57 1900_03_PG_03 Circumference
Prove that through three points not in a straight line one circumference and only one can be drawn.
- 58 1900_03_PG_04 Proofs: Triangle
Prove that two triangles are similar if an angle of one is equal to an angle of the other and the sides including these sides are proportional.
- 59 1900_03_PG_05 Proofs: Triangle
Prove that the areas of two similar triangles are to each other as the squares of any two homologous sides.
- 60 1900_03_PG_06 Polygons: Interior and Exterior Angles of
The ratio of the sum of the interior angles of a polygon to the sum of the exterior angles made by producing each of the sides in succession is as 5 to 1; how many sides has the polygon?
- 61 1900_03_PG_07 Circles: Chords, Secants and Tangents
B and C are the extremities of an arc of 120° on a circle whose radius is 2 inches; tangents at B and C meet at A. Find the perimeter of triangle ABC.
- 62 1900_03_PG_08 Circles: Chords, Secants and Tangents
From A, a point without a circle and 2 inches from the circumference, a secant is drawn through the Center O; AB, tangent the circle at B, is 21 inches long. Find the area of triangle AOB.
- 63 1900_03_PG_09 Polygons: Area of
Find one side of an equilateral triangle equivalent to a regular hexagon whose perimeter is 36 inches.
- 64 1900_03_PG_10 Polygons and Circles: Inscribed
Find the area of a circle inscribed in a rhombus whose perimeter is 100 inches and longer diagonal 40 inches.
- 65 1900_03_PG_11 Constructions
Show how to construct a line making an angle of 45° with a given line and tangent to a given circle.
- 66 1900_03_PG_12
Show how to construct a square, its diagonal being given.
- 67 1900_03_PG_13 Locus
Find the locus of the center of a circle with a given radius and tangent to a given circle a) internally, b) externally.
- 68 1900_03_PG_14 Proofs: Polygon
Prove that if the sides of any quadrilateral are bisected the figure formed by joining the adjacent points of bisection is a parallelogram.
- 69 1900_03_PG_15 Proofs: Circle
A circle whose center is A is tangent internally at O to a larger circle whose center is B; the line OCD cuts the smaller circle at C and the larger at D. Prove AC parallel to BD.
- 70 1900_06_PG_01 Definitions: Geometry
Define *rhombus*, *corollary*, *diagonal*, *radius*, *chord*.

- 71 1900_06_PG_02 Polygons: Interior and Exterior Angles of
Complete and demonstrate the following: the sum of the interior angles of any polygon is equal to:
- 72 1900_06_PG_03 Circles: Chords, Secants and Tangents
Complete and demonstrate the following: an angle formed by a tangent and a chord meeting it at the point of contact is measured by...
- 73 1900_06_PG_04 Proofs: Triangle
Prove that triangles which have their corresponding sides proportional are similar.
- 74 1900_06_PG_05 Proofs: Polygon
Prove that the circumference of a circle may be circumscribed about any regular polygon.
- 75 1900_06_PG_06 Triangles: Equilateral
Find the perimeter of an equilateral triangle whose area is 64 square feet.
- 76 1900_06_PG_07 Trigonometry: Finding Sides
The perpendicular from the vertex of a right triangle to the hypotenuse is 12 feet and the greater segment of the hypotenuse is 16 feet; find the length of each side of the triangle.
- 77 1900_06_PG_08 Trigonometry: Finding Sides
ABC is a triangle; D is the middle point of AC; AB = 7 feet, AD = 6 feet and BD = 4 ½ feet; find BC.
- 78 1900_06_PG_09 Circles: Chords, Secants and Tangents
The angle between two tangents to a circle is 60° and the length of the chord joining the points of contact is 8.66 feet; find the radius of the circle.
- 79 1900_06_PG_10 Polygons and Circles: Inscribed
A rectangle whose base is twice its altitude is inscribed in a circle whose radius is 5 feet; find the area of the rectangle.
- 80 1900_06_PG_11 Proofs: Circle
Two circles intersect in the points A and B; from any point on the line AB produced tangents are drawn to the given circles; prove that these tangents are equal.
- 81 1900_06_PG_12 Constructions
AB and CD are two lines intersecting at E; P is a point in the angle CEB; through P draw two lines each of which shall make equal angles with AB and CD. Give proof.
- 82 1900_06_PG_13 Constructions
Given the middle points of the three sides of a triangle; show how to construct the triangle.
1900_06_PG_14
- 83 1900_06_PG_14 Constructions
Given a line a; construct a line x so that $x = a\sqrt{2}$
- 84 1900_06_PG_15 Constructions
Show, by applying the construction in 14, how to divide a given triangle into two equal parts by a line parallel to one of the sides.
Note: The problem referred to reads as follows:
1900_06_PG_14 Constructions
Given a line a; construct a line x so that $x = a\sqrt{2}$
- 85 1909_01_PG_01 Proofs: Triangle
Prove that if two sides of a triangle are unequal, the opposite sides are unequal, and the greater angle is opposite the greater side.
- 86 1909_01_PG_02 Proofs: Circle
Prove that the tangents to a circle drawn from an exterior point are equal and make equal angles with the line joining the point to the center.
- 87 1909_01_PG_03 Proofs: Triangle
Prove that if a straight line divides two sides of a triangle proportionally, it is parallel to the third side.
- 88 1909_01_PG_04 Proofs: Triangle
Prove that the areas of two similar triangles are to each other as the squares of any two homologous sides.
- 89 1909_01_PG_05 Constructions
Show how to inscribe a square in a given circle and give proof.

- 90 1909_01_PG_06 Proofs: Circle
Prove that in any triangle the product of two sides is equal to the product of the diameter of the circumscribed circle by the altitude upon the third side.
- 91 1909_01_PG_07 Triangles: Interior and Exterior Angles of
The three angles of a triangle are 48° , 82° and 50° ; find the three angles formed by the bisectors of the angles of the triangle. Verify by using the theorem involving the sum of the angles about a point in a plane.
- 92 1909_01_PG_08 Circles: Chords
A chord 1 foot long is 4 inches from the center of a circle; how far from the center of the circle is a chord 9 inches long?
- 93 1909_01_PG_09 Circles: Arc Measure
A circle has an area of 80 square feet; find the length of an arc of 80° .
- 94 1909_01_PG_10 Proofs: Triangle
Prove that if the median of a triangle is equal to half the side to which it is drawn, the triangle is a right triangle.
- 95 1909_01_PG_11 Proofs: Triangle
Prove that if AB is a diameter of a circle and BC a tangent, and AC meets the circumference at D , the diameter is a means proportional between AC and AD .
- 96 1909_01_PG_12 Constructions
Given three lines a , b and c ; construct a line x so that $a:b::c:x$.
- 97 1909_06_PG_01 Proofs: Triangle
Prove that the perpendicular bisectors of the sides of a triangle meet in a point.
- 98 1909_06_PG_02 Proofs: Circle
Complete and prove the following: An angle formed by a tangent and a chord from the point of contact is measured by ...
- 99 1909_06_PG_03 Proofs: Polygon
Prove that two similar polygons are to each other as the squares of any two homologous sides.
- 100 1909_06_PG_04 Constructions
On a given line as a chord, construct the segment of a circle that shall contain an angle equal to a given angle.
- 101 1909_06_PG_05 Constructions
If a , b and c are straight lines construct a fourth line x , so that $x = \frac{ab}{c}$. Give proof.
- 102 1909_06_PG_06 Circles: Chords
A chord 16 inches long is 6 inches from the center of a circle; Find the length of a chord that is 5 inches from the center of the same circle.
- 103 1909_06_PG_07 Polygons: Interior and Exterior Angles of
Find (a) the number of sides of a regular polygon the sum of whose interior angles is three times the sum of its exterior angles, (b) the number of degrees in each angle of a regular decagon.
- 104 1909_06_PG_08 Proofs: Polygon
Prove that the bisectors of the opposite angles of a rhomboid are parallel.
- 105 1909_06_PG_09 Proofs: Polygon
Prove that the area of the figure whose vertices are the middle points of the sides of any quadrilateral is equal to half the area of the quadrilateral.
- 106 1909_06_PG_10 Proofs: Circle
 AB and CD are non-intersecting chords of the same circle and each is equal to the side of the inscribed square. AB is fixed but CD is movable. AD and BC intersect in P . Find the locus of P .
Or
If a circle is described on the radius of another circle as a diameter, any chord of the greater circle, passing through the point of contact of the circles, is bisected by the circumference of the smaller circle. Prove.

107 1920_01_PG_01 Proofs: Circle
 Prove that if in a circle two chords are equally distant from the center, they are equal. [12½]

108 1920_01_PG_02 Proofs: Triangle
 State *three* theorems concerning the similarity of triangles.
 Prove *one* of these theorems. [12½]

109 1920_01_PG_03 Polygons: Interior and Exterior Angles of
 The sum of the interior angles of a polygon of n sides is . . .
 Complete and prove. [12½]

110 1920_01_PG_04 Proofs: Polygon
 The area of a regular polygon is equal to . . .
 Complete and prove. [12½]

111 1920_01_PG_05 Proofs: Triangle
 Prove that two triangles are equal (and congruent) if the three sides of the one are equal respectively to the three sides of the other. [12½]

112 1920_01_PG_06 Polygons and Circles: Inscribed
 Find the number of square inches of tin that would be wasted in cutting the largest possible circular disk of tin from a piece in the form of an equilateral triangle 12 inches on a side. [12½]

113 1920_01_PG_07 Proofs: Circle
 In the figure, AB and CD are parallel tangents meeting a third tangent at A and C . O is the center of the circle. Prove that AOC is a right angle. [12½]

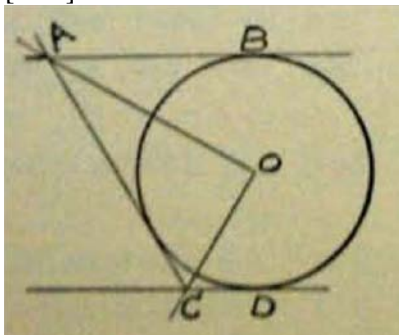

114 1920_01_PG_08 Circles: Chords, Secants and Tangents
 In the figure, CD is tangent to the circle, angle $C = 42$, arc $BD = 32$. Find in degrees the value of *each* of the angles of the triangle ABD . [12½]

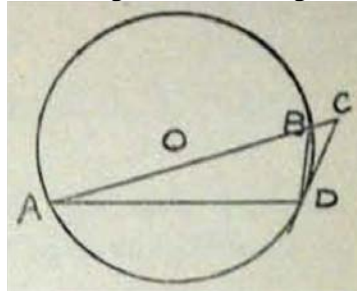

115 1920_01_PG_09 Special Quadrilaterals: Rhombuses
 The diagonals of an equilateral parallelogram (rhombus) are 24 inches and 70 inches. Find (a) the area, (b) the perimeter, (c) the altitude. [12½]

116 1920_01_PG_10 Constructions
 Given a , b , and c , lines of unequal length.
 Construct a fourth line x such that $x = \frac{ac}{b}$. Give proof. [12½]

117 1920_01_PG_11 Constructions
 a Construct a quadrilateral three of whose angles are 150° , 90° and 60° . [10½]

b How many degrees are there in the remaining angle? Why? [2]

118 1920_01_PG_12 Proofs: Circle

Given a circle circumscribed about triangle ABC .
 D is the midpoint of arc BC . AD and DC are drawn. To prove $AB \times AC = \overline{AE}^2 + BE \times EC$

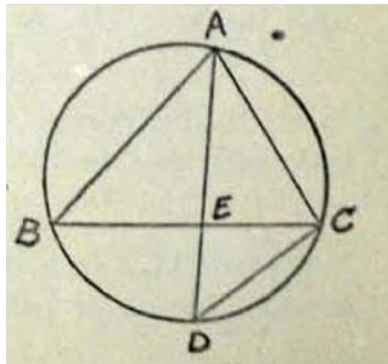

Assign a reason for each of the following statements:

1 $\angle BAD$ is measured by $\frac{1}{2}$ arc BD

$\angle CAD$ is measured by $\frac{1}{2}$ arc CD [1]

2.. $\angle BAD = \angle CAD$

3.. $\angle B = \angle D$ [2]

4 $\triangle BAE$ is similar to $\triangle DAC$ [2]

5 $\frac{AB}{AE + ED} = \frac{AE}{AC}$ [2]

6 $AB \times AC = \overline{AE}^2 + AE \times ED$ [1]

7 $AE \times ED = BE \times EC$ [2]

8 $AB \times AC = \overline{AE}^2 + BE \times EC$ [2]

119 1920_06_PG_01 Proofs: Polygon

Prove that if two opposite sides of a quadrilateral are equal and parallel, the figure is a parallelogram.

120 1920_06_PG_02 Proofs: Triangle

Prove that if a line divides two sides of a triangle proportionally, it is parallel to the third side.

121 1920_06_PG_03 Proofs: Circle

Prove that an angle formed by two secants intersecting outside of a circumference is measured by one half the difference of the intercepted arcs.

122 1920_06_PG_04 Proofs: Circle

Prove that a circle may be circumscribed about any regular polygon.

123 1920_06_PG_05 Definitions: Geometry

Answer *four* of the following:

a What is meant by saying that certain parts, for example, two sides and the included angle, *determine* a triangle?

b What is meant by saying that a central angle is *measured* by its intercepted arc?

c What is meant by saying that the area of a rectangle is equal to the product of its base and altitude?

d What is meant by saying that the ratio of any circumference to its diameter is *constant* and equal to π ?

e What two things must be shown in proving any line or group of line a locus?

f What is the difference between the statements "the square *on* the line AB " and "the square *of* the line AB "?

124 1920_06_PG_06 Constructions

Construct a square equivalent (equal in area) to a given parallelogram.

125 1920_06_PG_07 Constructions

Construct a tangent to a given circle (*a*) from a given external point, (*b*) at a given point on the circumference.

126 1920_06_PG_08 Constructions

Construct x if $x = \sqrt{a^2 + b^2}$ when a and b are two given lines.

127 1920_06_PG_09 Trigonometry: Finding Sides

The sides of a triangle are 9, 10, and 17. Compute (*a*) the altitude on side 9, (*b*) the median to side 10.

128 1920_06_PG_10 Circles: Tangents

Two tangents to a circle form an angle of 75° . Find (*a*) the number of degrees in each of the two intercepted arcs, (*b*) the length of the minor arc if the radius of the circle is 10".

- 129 1920_06_PG_11 Polygons: Area of
Two adjacent sides of a parallelogram are 8" and 12" respectively, and they form an angle of 60° . Find the area of the parallelogram.
- 130 1920_06_PG_12 Proofs: Polygon
Prove that if two diagonals of an inscribed regular pentagon intersect, the longer segment of either diagonal is equal to a side of the pentagon.
- 131 1920_06_PG_13 Proofs: Triangle
In the triangle ABC , medians AE and CD intersect at point O . Prove that the triangle AOC is equal in area to the quadrilateral $DBEO$.
- 132 1930_01_PG_01 Complementary, Supplementary and Vertical Angles
The bisectors of two complementary adjacent angles form an angle of _____ degrees.
- 133 1930_01_PG_02 Triangles: Equilateral
If the area of an equilateral triangle is $25\sqrt{3}$, the length of one side is _____.
- 134 1930_01_PG_03 Parallel and Perpendicular Lines
If two isosceles triangles have a common base, the line determined by their vertices is _____ to the base.
- 135 1930_01_PG_04 Polygons and Circles: Inscribed
The perimeter of a regular hexagon inscribed in a circle is 42 inches; the circumference of the circle in terms of π is _____ inches.
- 136 1930_01_PG_05 Special Quadrilaterals: Rhombuses
In the rhombus $ABCD$, if angle $B = 120^\circ$ and diagonal $BD = 10$, then the length of one side of the rhombus is _____.
- 137 1930_01_PG_06 Circles: Chords
 AB is a diameter and AK a chord in a circle such that angle $BAK = 55^\circ$; the number of degrees in arc AK is _____.
- 138 1930_01_PG_07 Triangles: Isosceles
In an isosceles triangle, each of the two equal sides is 12 and the angle included by them is 120° ; the length of the base is _____.
- 139 1930_01_PG_08 Special Quadrilaterals: Trapezoids
The bases of an isosceles trapezoid are 20 and 30 and the angles at the extremities of the longer base are each 45° ; the altitude is _____.
- 140 1930_01_PG_09 Circles: Chords, Secants and Tangents
The tangent to a circle at a vertex of an inscribed regular pentagon makes an acute angle of _____ degrees with one side.
- 141 1930_01_PG_10 Circles: Chords, Secants and Tangents
If a tangent and a secant drawn from the same point to a circle are 6 inches and 18 inches long respectively, the length of the external segment of the secant is _____ inches.
- 142 1930_01_PG_11 Similarity
If any angle of one isosceles triangle equals the corresponding angle of another isosceles triangle, then the two triangles are _____.
- 143 1930_01_PG_12 Special Quadrilaterals: Rhombuses
The equilateral quadrilateral that is not a regular polygon is called a _____.
- 144 1930_01_PG_13 Medians, Altitudes, Bisectors and Midsegments
Two altitudes of a triangle fall outside the triangle if the triangle is _____.
- 145 1930_01_PG_14 Similarity
The corresponding bases of two similar triangles are 2 and 3; if the area of the first triangle is 12, the area of the second is _____.
- 146 1930_01_PG_15 Triangle Inequalities
In triangle ABC , AB is greater than AC , and the bisector of angle A meets BC in D ; then angle BDA is _____ than angle CDA .

147 1930_01_PG_16 Proofs: Triangle
 If a diagonal is drawn in a quadrilateral whose opposite sides are equal, which of the following reasons would be used in proving that the triangles formed are congruent? (a) $s a s$; (b) $a s a$; (c) $s s s$

148 1930_01_PG_17 Similarity
 Which two of the following sets of numbers taken as sides of triangles will form similar triangles? (a) 8, 15, 27; (b) 4, 7, 9; (c) 4, $7\frac{1}{2}$, $13\frac{1}{2}$

149 1930_01_PG_18 Triangles: Mean Proportionals
 Construct the mean proportional between lines a and b .

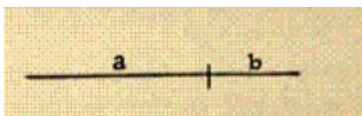

150 1930_01_PG_19 Constructions
 Given angle $BCA = 90^\circ$; construct an angle of 75° with vertex at C and with CB as one of its sides.

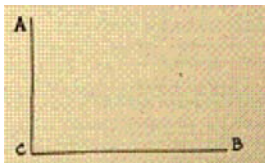

151 1930_01_PG_20 Locus
 Construct the locus of the centers of circles tangent to line m at point P .

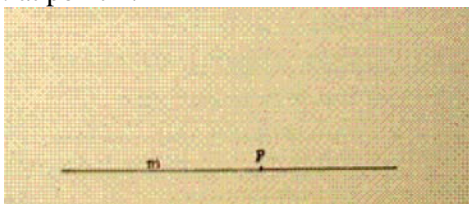

152 1930_01_PG_21 Proofs: Circle
 Prove that if two chords intersect within a circle, the product of the segments of one is equal to the product of the segments of the other. [12]

153 1930_01_PG_22 Proofs: Triangle
 In triangle ABC , R and S are the mid-points of sides AC and BC respectively. Line RS is extended its own length through S to point P and line PB is drawn.
 Prove

- (a) $BP = AR$,
- (b) BP is parallel to AR . [8,4]

154 1930_01_PG_23 Constructions
 a Given two points, A and B , on an indefinite line m and two other lines whose lengths are represented by a and b , with b greater than a . By actual construction locate a point C that shall be a distance a from line m and a distance b from the mid-point of segment AB . [10]
 b How many such points are there? [2]

155 1930_01_PG_24 Triangle Inequalities
 In triangle ABC , side AB is greater than side AC . If the bisectors of angles B and C meet in point P , prove that PB is greater than PC . [12]

156 1930_01_PG_25 Proofs: Triangle
 D is any point in side AC of triangle ABC and line DE joins D to any point E on the extension of side BA through A .

Prove $\frac{\text{triangle } ADE}{\text{triangle } ABC} = \frac{AD \times AE}{AC \times AB}$ [12]

[Suggestion: Draw the altitudes of triangles ADE and ABC from vertices D and C respectively.]

157 1930_01_PG_26 Polygons: Area of
 $ABCD$ is a parallelogram with side $AB = 18$, side $AD = 12$ and angle $A = 60^\circ$.

- a Find the area of parallelogram $ABCD$. [10]
- b If M , any point in CD , is joined to A and B , find the area of triangle ABM . [2]

158 1930_01_PG_27 Circles: Chords, Secants and Tangents
 $ABCD$ is a rectangle inscribed in a circle, the minor arc of chord AB containing 98° . Diagonal CA extended through A meets in point E the tangent drawn at D . Find the number of degrees in angle E . [12]

- 159 1930_01_PG_28 Circles: Center, Radius and Circumference
Two circles have radii of 6 inches and 8 inches. The circumferences of a third circle is equal to the combined circumference of the two circles. What is the area of this third circle? [Use $\pi = 3\frac{1}{7}$] [12]
- 160 1930_01_PG_29 Triangles: Pythagoras
A boat travels north 20 miles, then east 8.1 miles and then north 16 miles; how far from the starting point is the final position of the boat? [12]
- 161 1930_06_PG_01 Complementary, Supplementary and Vertical Angles
The difference between the supplement and the complement of an angle is always _____ degrees.
- 162 1930_06_PG_02 Proofs: Triangle
Two triangles are congruent if three _____ of one are equal to the corresponding parts of the other.
- 163 1930_06_PG_03 Triangles: Isosceles
If from any point in the bisector of an angle a line is drawn parallel to one side of the angle and cutting the other side, the triangle thus formed is _____.
- 164 1930_06_PG_04 Circles: Chords
If two parallel chords of a circle are 24 inches long and the distance between them is 10 inches, the radius of the circle is _____ inches long.
- 165 1930_06_PG_05 Polygons: Interior and Exterior Angles of
If each exterior angle of a regular polygon is 72° , then the number of sides of the polygon is _____.
- 166 1930_06_PG_06 Circles: Tangents
If two circles touch each other externally, the greatest number of common tangents that can be drawn is _____.
- 167 1930_06_PG_07 Special Quadrilaterals: Rhombuses
If the diagonals of a rhombus are 6 inches and 8 inches, then one side of the rhombus is _____ inches long.
- 168 1930_06_PG_08 Triangles: Equilateral
If one side of an equilateral triangle is 8 inches long, its altitude is _____ inches. [Leave answer in radical form.]
- 169 1930_06_PG_09 Triangles: Isosceles
Two isosceles triangles have equal vertex angles. If their bases are 2 inches and 3 inches, then the ratio of their area is _____.
- 170 1930_06_PG_10 Polygons: Area of
The base of a triangle is divided into three equal parts. If the points of division are joined to the opposite vertex, the three triangles thus formed are _____.
- 171 1930_06_PG_11 Trigonometry: Finding Sides
Two sides of a triangle are 3 inches and 6 inches long and the angle between them is 60° . The third side of this triangle is _____ inches long. [Leave answer in radical form.]
- 172 1930_06_PG_12 Locus
A circle rolls along a straight line; the locus traced by the center of the circle is _____.
- 173 1930_06_PG_13 Parallel and Perpendicular Lines
Two parallel lines are cut by a transversal. If one of the two interior angles on the same side of this transversal is three times the other, the number of degrees in the larger angle is _____.
- 174 1930_06_PG_14 Circles: Chords
In any circle, an angle inscribed in an arc that is less than a semicircle is an _____ angle.
- 175 1930_06_PG_15 Triangle Inequalities
If base AB of isosceles triangle ABC is extended through B to point D , and D is joined to C , then line AC will be _____ than line DC .
- 176 1930_06_PG_16 Circles: Arc Measure
Triangle ABC is inscribed in a circle. If angle $A = 42^\circ$ and angle $B = 68^\circ$, then the number of degrees in minor arc AB is _____.

177 1930_06_PG_17 Circles: Area of
 In a circle whose radius is 10 inches, the area of a sector whose arc is 18 inches long is _____ square inches.

178 1930_06_PG_18 Constructions
 Construct a triangle in which a , b , and C will be two sides and the included angle.

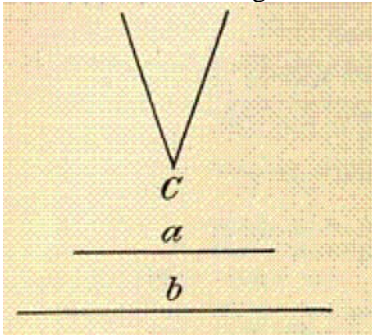

179 1930_06_PG_19 Locus
 Locate *one* point in line DE that shall be equidistant from the sides of angle ABC .

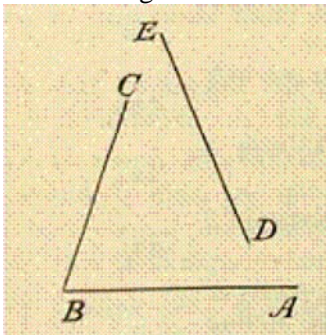

180 1930_06_PG_20 Construction
 Construct the fourth proportional to lines a , b , and c .

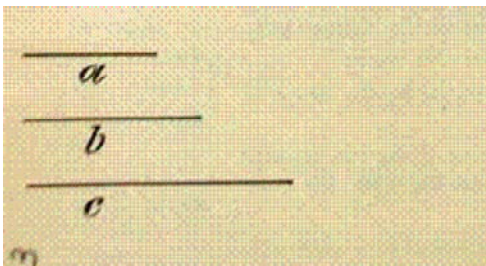

181 1930_06_PG_21 Proofs: Polygon
 Prove that if the opposite sides of a quadrilateral are equal the figure is a parallelogram. [12]

182 1930_06_PG_22 Triangles: Mean Proportionals
 Prove that if from a point outside a circle a tangent and a secant are drawn to the circle the tangent is the mean proportional between the secant and its external segment. [12]

183 1930_06_PG_23 Proofs: Triangle
 In triangle ABC the bisector of angle C meets side AB in D . A line through vertex A parallel to line CD meets side BC produced in point E . Prove that line CE equals line CA . [12]

184 1930_06_PG_24 Constructions
 Given an indefinite line m a fixed point P on line m and a fixed point A not on line m ; locate by actual construction the center of a circle that shall touch line m at point P and shall also pass through points P and A . [No proof required.] [12]

185 1930_06_PG_25 Proofs: Triangle
 In triangle ABC P is any point in side AB and D and E are mid-points of AC and BC respectively. If P is joined to D and E prove that quadrilateral $PECD = \frac{1}{2}$ triangle ABC . [12]

186 1930_06_PG_26 Triangles: Mean Proportionals
 ABC is a right triangle and CD is the altitude on hypotenuse AB . If $AC = 32$ and $BC = 24$, find AB , AD and CD . [12]

187 1930_06_PG_27 Similarity: Right Triangles
 Two boys wish to find the height of a light suspended above the gymnasium floor. From a point directly under the light they measure out a distance of 18 feet. At that point the shadow cast by a vertical pole 9 feet long is measured and found to be 12 feet long. Find the height of the light from these measurements. [12]

- 188 1930_06_PG_28 Polygons and Circles: Inscribed
Triangle ABC is inscribed in a circle and the tangent C meets in point D the side AB produced through B . If angle $D = 42^\circ$ and arc $ACB = 148^\circ$, find each angle of triangle ABC . [12]
- 189 1930_06_PG_29 Circles: Area of
Three circles, each with a radius of 6 inches, touch each other externally, each circle being tangent to the other two. Find the area contained between the three circles.
[Leave answer in irrational form.] [12]
- 190 1930_08_PG_01 Complementary, Supplementary and Vertical Angles
If two acute angles have their sides respectively perpendicular to each other, the two angles are _____.
- 191 1930_08_PG_02 Medians, Altitudes, Bisectors and Midsegments
If the altitude of an equilateral triangle is 15 inches, the median of the triangle meet in a point _____ inches from the vertex.
- 192 1930_08_PG_03 Triangle Inequalities
In the parallelogram $ABCD$, if BC is less than CD and if the diagonal DB is drawn, then angle ADB is _____ than angle BDC .
- 193 1930_08_PG_04 Polygons: Area of
If similar polygons are constructed on a side and a diagonal of a square, the ratio of their areas is _____.
- 194 1930_08_PG_05 Triangles: Interior and Exterior Angles of
If the sum of the exterior angle at A and the exterior angle at B of the triangle ABC is 270° , then triangle ABC must be a _____ triangle.
- 195 1930_08_PG_06 Circles: Chords
A diameter of a circle is the locus of the mid-points of a series of _____ chords of the circle.
- 196 1930_08_PG_07 Circles: Tangents
If angle P , formed by two tangents PA and PB drawn to circle O , is 70° and if OA and OB are drawn, then angle AOB contains _____ degrees.
- 197 1930_08_PG_08 Special Quadrilaterals: Squares
The regular polygon whose apothem equals one half a side is called a _____.
- 198 1930_08_PG_09 Special Quadrilaterals: Parallelograms
If the diagonals of an oblique parallelogram form four congruent triangles, the parallelogram is a _____.
- 199 1930_08_PG_10 Circles: Chords
 AB is a diameter of a circle and AC is a chord such that angle BAC is 30° ; if AB is 12 inches long, then chord AC is _____ inches long.
- 200 1930_08_PG_11 Proofs: Triangle
If two sides of one triangle equal two sides of another triangle and the included angles are supplementary, the two triangles are _____.
- 201 1930_08_PG_12 Special Quadrilaterals: Trapezoids
If one base of a trapezoid is twice the other base and if the altitude is 6 and the area 81, then the shorter base is _____.
- 202 1930_08_PG_13 Triangles: Special Right
In the triangle whose sides are 1.5, 2 and 2.5, the angle opposite 2.5 must contain _____ degrees.
- 203 1930_08_PG_14 Circles: Area of
If the circumference of a circle is 14π , the area is _____ [Leave answer in terms of π]

204 1930_08_PG_15 Similarity
 If two chords intersect within a circle and the ends of the chords are joined by straight lines, either opposite pair of triangles formed are _____.

205 1930_08_PG_16 Circles: Chords, Secants and Tangents
 If a central angle and the angle formed by a tangent and a chord intercept the same arc, the ratio of the angles is _____.

206 1930_08_PG_17 Triangles: Mean Proportionals
 If the altitude on the hypotenuse of a right triangle divides the hypotenuse into segments 9 and 4, the area of the triangle is _____.

207 1930_08_PG_18 Constructions
 Find by construction the center of the circle.

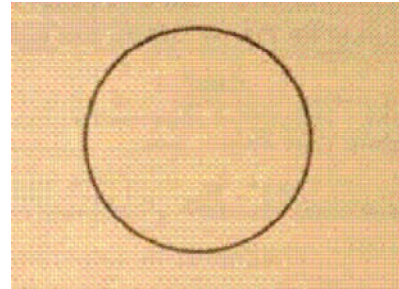

208 1930_08_PG_19 Constructions
 Construct the equilateral triangle whose altitude is the line AB .

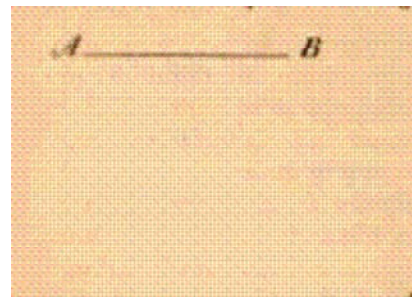

209 1930_08_PG_20 Constructions
 Divide the line AB into parts proportional to the lines a , b , and c .

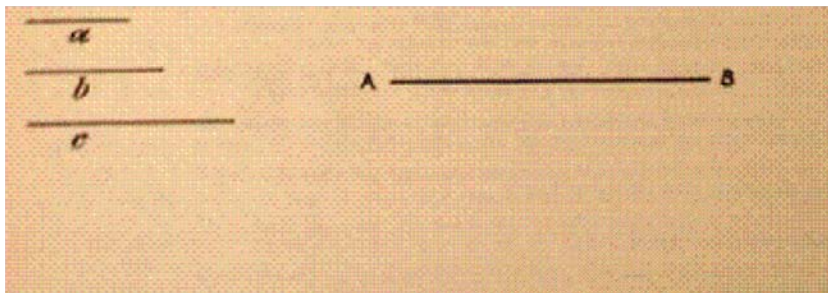

210 1930_08_PG_21 Proofs: Triangle
 Prove that two triangles are congruent if the three sides of one are equal respectively to the three sides of the other. [12]

211 1930_08_PG_22 Circles: Chords
 Prove that the angle formed by two chords intersecting within a circle is measured by one half the sum of the intercepted arcs. [12]

- 212 1930_08_PG_23 Proofs: Polygon
In trapezoid $ABCD$, the base AB is twice the base of DC .
If the diagonals AC and BD intersect in point E , prove
that CE is one third of AC . [12]
- 213 1930_08_PG_24 Proofs: Triangle
If X is any point in the diagonal AC of parallelogram
 $ABCD$, prove that triangle ABX is equal in area to
triangle AXD . [12]
- 214 1930_08_PG_25 Constructions
By actual construction determine a circle that will be
tangent to the sides of a given triangle, touching one side
at a given point. [12]
- 215 1930_08_PG_26 Triangles: Pythagoras
Two sides of a triangle are 13 inches and 15 inches. If
the altitude on the third side is 12 inches, what is the
area of the triangle? [12]
- 216 1930_08_PG_27 Polygons and Circles: Inscribed
 $ABCDE$ is a regular pentagon inscribed in a circle.
- a* Find the number of degrees in the acute angle
formed by side DC and the tangent at D . [4]
- b* Find the number of degrees in the angle formed
by extending sides AB and DC to meet. [8]
- 217 1930_08_PG_28 Medians, Altitudes, Bisectors and Midsegments
In triangle ABC , $AB = 18$, $AC = 12$ and angle $A = 60^\circ$.
Find the length of median AM drawn from A . [Leave
answer in radical form.] [12]
- [Suggestion: Drop perpendiculars to AB from points C
and M .]
- 218 1930_08_PG_29 Similarity: Right Triangles
A man stands on a 24-foot ladder which touches the wall
of a building 16 feet above the ground. If he stands on
a round 9 feet from the top of the ladder, how far are his
feet from the ground? [8] Find to the *nearest foot* the
distance from the wall to the foot of the ladder. [4]

PG - The Plane Geometry Curriculum (1940-1950)

- 199 1940_06_PG_01 Circles: Arc Measure
A central angle of 40° intercepts an arc of ... degrees.
- 200 1940_06_PG_02 Circles: Chords
The angle formed by two chords intersecting within a circle is measured by one half the ... of the intercepted arcs.
- 201 1940_06_PG_03 Circles: Center, Radius and Circumference
The number π is a constant which represents the ratio between the circumference and the ... of a circle.
- 202 1940_06_PG_04 Circles: Center, Radius and Circumference
If the area of a circle is 16π , the radius of the circle is
- 203 1940_06_PG_05 Polygons and Circles: Inscribed
The center of a circle circumscribed about a triangle is equidistant from the three ... of the triangle.
- 204 1940_06_PG_06 Triangles: Isosceles
If one of the equal angles of an isosceles triangle contains 65° , the smallest angle of the triangle contains ... degrees.
- 205 1940_06_PG_07 Triangle Inequalities
Two triangles with equal bases and equal altitudes are always
- 206 1940_06_PG_08 Similarity
Two corresponding sides of two similar triangles are 8 and 12. If an altitude of the smaller triangle is 6, the corresponding altitude of the larger triangle is
- 207 1940_06_PG_09 Circles: Chords, Secants and Tangents
If a secant to a circle from an external point is 9 and its external segment is 4, the length of the tangent from that point is
- 208 1940_06_PG_10 Similarity
If two triangles are similar and the area of one is four times the area of the other, a side of the larger triangle is ... times the corresponding side of the smaller.
- 209 1940_06_PG_11 Triangles: Pythagoras
If the hypotenuse of a right triangle is 17 inches and one leg is 15 inches, the other leg is ... inches.
- 210 1940_06_PG_12 Polygons: Area of
The area K of a regular polygon of n sides, whose apothem is a and whose side is s , is given by the formula $K = \dots$
- 211 1940_06_PG_13 Trigonometry: Law of Sines
 ABC is an isosceles triangle with AB and AC the equal sides. If angle B contains 35° and BC equals 20, the altitude upon BC , correct to the nearest integer, is
- 212 1940_06_PG_14 Triangles: Mean Proportionals
If the altitude CD is drawn to the hypotenuse AB of the right triangle ABC , AC is the mean proportional between (a) AD and DB , (b) AB and AD or (c) AB and BC .
- 213 1940_06_PG_15 Special Quadrilaterals: Parallelograms
 AC and BD are diagonals of parallelogram $ABCD$. If $\angle DAB = 50^\circ$, then (a) $AC = BD$, (b) $AC < BD$ or (c) $AC > BD$.
- 214 1940_06_PG_16 Triangles: Special Right
If in right triangle ABC , $\angle A = 30^\circ$, $\angle B = 60^\circ$, then (a) $AC = 2BC$, (b) $AC = \frac{1}{2}AB$ or (c) $AC = BC\sqrt{3}$.
- 215 1940_06_PG_17 Special Quadrilaterals: Rectangles and Squares
The diagonals of a rectangle are always (a) equal and perpendicular to each other, (b) perpendicular and bisect each other or (c) equal and bisect each other.

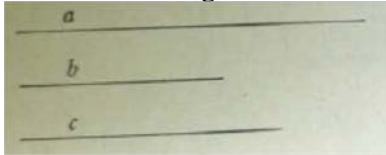
- 216 1940_06_PG_18 Circles: Chords
Indicate whether this statement is *always* true, *sometimes* true or *never* true.
If two chords of a circle intersect, the product of the segments of one chord is equal to the product of the segments of the other.
- 217 1940_06_PG_19 Special Quadrilaterals: Trapezoids
Indicate whether this statement is *always* true, *sometimes* true or *never* true.
The diagonals of a trapezoid are equal.
- 218 1940_06_PG_20 Proofs: Triangle
Indicate whether this statement is *always* true, *sometimes* true or *never* true.
Two right triangles are congruent if the legs of one are equal to the legs of the other.
- 219 1940_06_PG_21 Polygons: Interior and Exterior Angles of
Indicate whether this statement is *always* true, *sometimes* true or *never* true.
The sum of the interior angles on any quadrilateral is equal to the sum of its exterior angles.
- 220 1940_06_PG_22 Circles: Chords
Indicate whether this statement is *always* true, *sometimes* true or *never* true.
If in a given circle arc AB equals arc BC , then chord AC is twice chord AB .
- 221 1940_06_PG_23 Constructions
Given line segments a , b , and c
Construct line segment x such that $a:b = c:x$
- 
- 222 1940_06_PG_24 Constructions
Construct an angle of 30° .
- 223 1940_06_PG_25 Constructions
Construct the locus of points equidistant from the two given parallel lines r and s .
- 224 1940_06_PG_26 Proofs: Circle
Prove that tangents drawn to a circle from an external point are equal. [10]
- 225 1940_06_PG_27 Proofs: Polygon
 $ABCDE$ is an equilateral pentagon inscribed in a circle. FG is tangent to the circle at point A . Prove that FG is parallel to CD . [10]
- 226 1940_06_PG_28 Proofs: Polygon
Prove that the area of a trapezoid is equal to one half the product of its altitude and the sum of its bases. [10]
- 227 1940_06_PG_29 Proofs: Circle
 RS is a diameter of a circle and NS a chord. At D , a point on RS extended through S , a line perpendicular to RD is drawn. NS extended meets this perpendicular at M . RN is drawn.
a) Prove that $\triangle RNS$ and $\triangle SDM$ are similar. [6]
b) If $RS = 30$, $MS = 16$ and $NS = 10$, find the length of SD . [4]
- 228 1940_06_PG_30 Special Quadrilaterals: Rhombuses
The longer diagonal of a rhombus is 24 feet and the shorter diagonal is 10 feet.
a) Find the perimeter of the rhombus. [4]
b) Find, correct to the *nearest degree*, the angle which the longer diagonal makes with a side of the rhombus. [6]
- 229 1940_06_PG_31 Circles: Area of
The radius of a circle is 12 and a minor segment of this circle has a chord equal to the radius.
a) Find the perimeter of the minor segment. [4]
b) Find the area of the minor segment. [6]
[Answers may be left in radical form and in terms of π .

- 230 1940_06_PG_32 Locus
- What is the locus of the vertex of the right angle of a right triangle whose hypotenuse is a given line segment? [1]
 - What is the locus of the vertex of angle C of triangle ABC in which AB and the median m upon AB are given line segments? [1]
 - What is the locus of the vertex of angle E of triangle DEF in which DF and the altitude h upon DF are given line segments? [2]
 - If the hypotenuse and the median upon the hypotenuse of a right triangle are given, is the triangle determined? Explain. [1,2]
 - If three line segments, s , m and h , are chosen at random to represent a side of a triangle, the median and the altitude to that side respectively, is it always possible to construct the triangle? Explain. [1,2]
- 231 1940_06_PG_33 Logical Reasoning: Converse
- Explain what is meant by a converse of a proposition in geometry. [2]
 - Does every proposition have a converse? [1]
 - State a proposition of which a converse is not true and write this converse. [3]
 - State two converses of the following proposition: The diameter of a circle perpendicular to a chord of the circle bisects the chord and the arcs determined by the chord. [4]
- 232 1940_08_PG_01 Trigonometry: Finding Sides
In the right triangle ABC , if angle B equals 30° and AC equals 2 inches, then the hypotenuse AB equals _____ inches.
- 233 1940_08_PG_02 Special Quadrilaterals: Rhombuses
If the midpoints of two adjacent sides of a rhombus are joined, the triangle formed is _____.
- 234 1940_08_PG_03 Circles: Center, Radius and Circumference
If the area of a circle is 49π , the circumference in terms of π is _____.
- 235 1940_08_PG_04 Triangles: Mean Proportionals
If the altitude upon the hypotenuse of a right triangle divides the hypotenuse into segments of 18 and 32, then the shorter leg of the given triangle is _____.
- 236 1940_08_PG_05 Trigonometry: Finding Sides
If in right triangle ABC angle $C = 90^\circ$, angle $A = 70^\circ$, and $AB = 50$. then AC correct to the nearest integer is _____.
- 237 1940_08_PG_06 Special Quadrilaterals: Rhombuses
If the diagonals of a rhombus are 6 and 8, then the area of the rhombus is _____.
- 238 1940_08_PG_07 Circles: Chords
Point P is a distance of 6 from the center of a circle whose radius is 10; the product of the segments of any chord drawn through P is _____.
- 239 1940_08_PG_08 Circles: Area of
The radius of a circle is 9 and the angle of a sector of this circle is 40° ; the area of this sector in terms of π is _____.
- 240 1940_08_PG_09 Similarity
Two triangles are similar and the area of the first triangle is four times the area of the second. If a side of the first triangle is 8, then the corresponding side of the second is _____.
- 241 1940_08_PG_10 Circles: Tangents
The length of a tangent drawn from a point 3 inches from a circle whose radius is 12 inches is _____ inches.
- 242 1940_08_PG_11 Complementary, Supplementary and Vertical Angles
Vertical angles are always (a) acute, (b) equal or (c) supplementary.
- 243 1940_08_PG_12 Triangles: Interior and Exterior Angles of
An exterior angle at the base of an isosceles triangle is always (a) an acute angle, (b) an obtuse angle or (c) a right angle.

244 1940_08_PG_13 Special Quadrilaterals: Rectangles and Squares
All quadrilaterals whose equal diagonals bisect each other are (a) rectangles, (b) squares or (c) rhombuses.

245 1940_08_PG_14 Circles: Chords, Secants and Tangents
The angle that is measured by one half the difference of its intercepted arcs has its vertex (a) within the circle, (b) on the circle or (c) outside the circle.

246 1940_08_PG_15 Circles: Chords
The two chords that form the sides of an angle inscribed in a semicircle are always (a) equal, (b) unequal or (c) perpendicular to each other.

247 1940_08_PG_16 Circles: Tangents
The number of circles that can be tangent to two intersecting lines is (a) two, (b) four or (c) unlimited.

248 1940_08_PG_17 Triangle Inequalities
Indicate whether the following statement is *always true*, *sometimes true* or *never true* by writing the word *always*, *sometimes* or *never*.
If one angle of a triangle is 60° and the other two angles are unequal, the side opposite the 60° angle is the longest side of the triangle.

249 1940_08_PG_18 Polygons: Interior and Exterior Angles of
Indicate whether the following statement is *always true*, *sometimes true* or *never true* by writing the word *always*, *sometimes* or *never*.
If a polygon is equilateral, it is equiangular.

250 1940_08_PG_19 Circles: Chords
Indicate whether the following statement is *always true*, *sometimes true* or *never true* by writing the word *always*, *sometimes* or *never*.
If in the same circle or in equal circles two chords are equal, they are equidistant from the center.

251 1940_08_PG_20 Similarity
Indicate whether the following statement is *always true*, *sometimes true* or *never true* by writing the word *always*, *sometimes* or *never*.
Similar triangles are congruent triangles.

252 1940_08_PG_21 Polygons: Interior and Exterior Angles of
Indicate whether the following statement is *always true*, *sometimes true* or *never true* by writing the word *always*, *sometimes* or *never*.
If the number of sides in a polygon is increased by 2, the sum of the exterior angles of this polygon, made by producing each of its sides in succession, remains the same.

253 1940_08_PG_22 Logical Reasoning: Converse
Is the converse of the following theorem true: "Two parallel lines intercept equal arcs on a circle"? [Answer Yes or No.]

254 1940_08_PG_23 Constructions
Find the locus of the centers of all circles which will pass through the two points A and B.

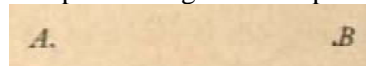

255 1940_08_PG_24 Constructions
Find the center of the circle that may be inscribed in the triangle ABC.

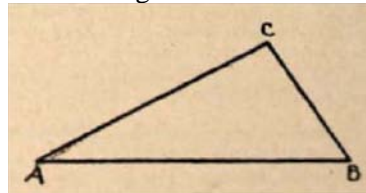

256 1940_08_PG_25 Constructions
Angles A and B are two angles of triangle ABC. Construct angle C.

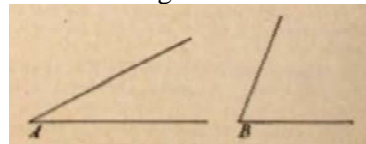

257 1940_08_PG_26 Proofs: Polygons
Prove that if two sides of a quadrilateral are equal and parallel, the figure is a parallelogram. [10]

258 1940_08_PG_27 Proofs: Polygon
Prove that if two triangles have an angle of one equal to an angle of the other and the sides including these angles proportional, the triangles are similar. [10]

- 259 1940_08_PG_28 Proofs: Circle
 A, B, C and D are four points taken consecutively on a circle and so located that arc BC is twice each of the arcs AB and CD . Chords AC and BD are drawn intersecting in M and chord DC is drawn. Prove that triangle DCM is isosceles. [10]
- 260 1940_08_PG_29 Proofs: Circle
 A trapezoid is inscribed in a circle whose radius is 17 inches, the center of the circle lying within the trapezoid. Find the area of the trapezoid if its bases are 8 inches and 15 inches from the center. [10]
- 261 1940_08_PG_30 Polygons and Circles: Inscribed
 The diameter of a circle is 20 inches.
 a Find the length of the apothem and the area of a regular inscribed hexagon. [5]
 b Find the length of a side and the area of an inscribed equilateral triangle. [5]
 [Both answers may be left in radical form.]
- 262 1940_08_PG_31 Medians, Altitudes, Bisectors and Midsegments
 The altitude of a triangle is 12 inches and it divides the vertex angle into two angles of 31° and 45° .
 a Find the lengths of the segments of the base. [6]
 b Find, correct to the nearest square inch, the area of the triangle. [4]
- 263 1940_08_PG_32 Special Quadrilaterals: Parallelograms
 Given parallelogram $ABCD$ with diagonal BD . A line from C cuts BD in E and AB in F .
 a Prove triangle BEF similar to triangle CDE . [3]
 b If F is the mid-point of AB , what is the relation between BE and ED ? Give reason. [3]
 c Using your answer to b , find the area of triangle CED if the area of triangle BEC is 100 square inches. [4]
- 264 1940_08_PG_33 Medians, Altitudes, Bisectors and Midsegments
 The medians of a triangle are 18, 15 and 15. Find the area of the triangle formed by joining the feet of the three medians. [10]
- 265 1950_01_PG_01 Special Quadrilaterals: Parallelograms
 In parallelogram $ABCD$, angle $BAD = 70^\circ$. Find the number of degrees in angle ABC .
- 266 1950_01_PG_02 Polygons: Interior and Exterior Angles of
 How many degrees are there in each exterior angle of an equiangular polygon of 10 sides?
- 267 1950_01_PG_03 Circles: Chords
 Two chords intersecting within a circle intercept opposite arcs of 60° and 100° . Find the number of degrees in an acute angle formed by the chords.
- 268 1950_01_PG_04 Trigonometry: Finding Angles
 In triangle ABC , angle $C = 90^\circ$ and AB is twice BC . Find the number of degrees in angle A .
- 269 1950_01_PG_05 Circles: Chords
 A chord 16 inches long is 5 inches from the center of the circle. Find the radius of the circle. [Answer may be left in radical form.]
- 270 1950_01_PG_06 Triangles: Mean Proportionals
 The altitude to the hypotenuse of a right triangle divides the hypotenuse into segments one of which is 4. If the altitude is 10, find the other segment of the hypotenuse.
- 271 1950_01_PG_07 Circles: Chords
 Circles: Chords AB and CD of a circle intersect at E . $AE = 8$, $EB = 9$ and $DE = 6$. Find EC .
- 272 1950_01_PG_08 Circles: Chords, Secants and Tangents
 From a point outside a circle, a tangent and a secant are drawn to the circle. If the tangent is 6 and the secant is 12, find the external segment of the secant.
- 273 1950_01_PG_09 Circles: Chords, Secants and Tangents
 From point P , lines are drawn tangent to a circle at points A and B . Chord AB is drawn. If angle P is 50° , find the number of degrees in angle PAB .
- 274 1950_01_PG_10 Similarity
 The corresponding sides of two similar polygons are in the ratio 1: 3. Find the ratio of the perimeters of the polygons.

- 275 1950_01_PG_11 Medians, Altitudes, Bisectors and Midsegments
The line segment joining the midpoints of the legs of a right triangle is 10. Find the hypotenuse.
- 276 1950_01_PG_12 Special Quadrilaterals: Rectangles and Squares
Find the diagonal of a square whose side is 10. [Answer may be left in radical form.]
- 277 1950_01_PG_13 Triangles: Equilateral
Find the area of an equilateral triangle whose side is 10. [Answer may be left in radical form.]
- 278 1950_01_PG_14 Triangles: Equilateral
The altitude of an equilateral triangle is 6. Find the radius of the inscribed circle.
- 279 1950_01_PG_15 Circles: Arc Measure
In a circle whose radius is 24 inches, find the length of an arc of 30° . [Answer may be left in terms of π .]
- 280 1950_01_PG_16 Circles: Center, Radius and Circumference
Find the radius of a circle whose area is 64π .
- 281 1950_01_PG_17 Trigonometry: Finding Angles
Find to the *nearest degree* the angle of elevation of the sun when a 25-foot vertical flagpole casts a shadow 10 feet long.
- 282 1950_01_PG_18 Locus
Point P is on line m . How many points are there which are 2 inches from m and 3 inches from P ?
- 283 1950_01_PG_19 Logical Reasoning: Converses
Is statement B the converse of statement A ? [Answer *yes* or *no*.]
 A If two triangles are congruent, then they are similar.
 B If two triangles are similar, then they are congruent.
- 284 1950_01_PG_20 Triangle Inequalities
In triangle ABC , angle $A = 60^\circ$ and AB is greater than AC . The smallest angle of the triangle is (a) angle A (b) angle B (c) angle C .

- 285 1950_01_PG_21 Triangle Inequalities
Two sides of a triangle are 5 and 8. The third side is (a) less than 3 (b) equal to 3 (c) greater than 3.
- 286 1950_01_PG_22 Definitions: Geometry
According to your textbook, the definition of a parallelogram is: (a) a parallelogram is a quadrilateral whose opposite sides are equal (b) a parallelogram is a quadrilateral whose opposite sides are parallel (c) a parallelogram is a quadrilateral two of whose sides are both equal and parallel
- 287 1950_01_PG_23 Polygons and Circles: Inscribed
The center of a circle inscribed in a triangle is the intersection of the (a) altitudes (b) angle bisectors (c) perpendicular bisectors of the sides of the triangle.

- 288 1950_01_PG_24 Constructions
Construct the median to side AC of the given triangle ABC .

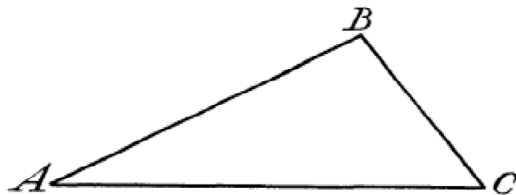

- 289 1950_01_PG_25 Constructions
Using the given line segments r , s and t , construct x so that $r:s = t:x$.

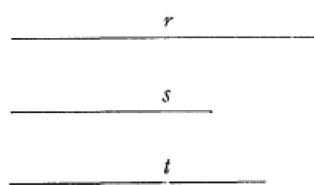

- 290 1950_01_PG_26 Proofs: Polygon
Prove that the diagonals of a parallelogram bisect each other. [10]

- 291 1950_01_PG_27 Proofs: Circle
Line ABC is tangent to circle O at B . Line ADE is drawn through the center of the circle cutting it in points D and E . Chord BF is drawn parallel to AE and radii OF and OB are drawn.
Prove that angle CBF is complementary to angle FOE . [10]
- 292 1950_01_PG_28 Proofs: Polygon
 AB and DC are the bases of trapezoid $ABCD$. Diagonals AC and BD meet in E .
Prove: a Triangle ABE is similar to triangle DCE . [5]
 b Triangle ADE is equal in area to triangle BCE . [5]
- 293 1950_01_PG_29 Proofs: Polygon
Prove that the area of a regular polygon is equal to one half the product of its perimeter and its apothem. [10]
- 294 1950_01_PG_30 Trigonometry: Finding Sides
In parallelogram $ABCD$, BE is an altitude to base AD . Angle $A = 41^\circ$, $AB = 12$ and diagonal $BD = 10$.
 a Find BE to the nearest integer. [4]
 b Find AE to the nearest integer. [3]
 c Using the values found in answer to parts a and b , find DE and the area of $ABCD$. [1, 2]
- 295 1950_01_PG_31 Proofs: Polygon
In trapezoid $ABCD$, base BC is to base AD as 3 is to 8. Legs AB and DC are extended to meet at E and the altitude EF of triangle AED intersects BC at G . The area of triangle AED is 192 and $EF = 24$.
 a Find AD . [2]
 b Find BC and EG . [2, 2]
 c Find the area of $ABCD$. [4]
- 296 1950_01_PG_32a Medians, Altitudes, Bisectors and Midsegments
If the blank in the following statement is filled by one of the words, *always*, *sometimes*, or *never*, the resulting statement will be true. Write on your answer paper the the word that will correctly complete the statement.
A median of a triangle _____ divides it into two congruent triangles. [2]
- 297 1950_01_PG_32b Circles: Chords
If the blank in the following statement is filled by one of the words, *always*, *sometimes*, or *never*, the resulting statement will be true. Write on your answer paper the the word that will correctly complete the statement.
If two chords of a circle bisect each other, the opposite intercepted arcs are _____ equal. [2]
- 298 1950_01_PG_32c Medians, Altitudes, Bisectors and Midsegments
If the blank in the following statement is filled by one of the words, *always*, *sometimes*, or *never*, the resulting statement will be true. Write on your answer paper the the word that will correctly complete the statement.
In triangle ABC , if AB is greater than AC , the altitude to AB is _____ greater than the altitude to AC . [2]
- 299 1950_01_PG_32d Special Quadrilaterals: Rhombuses
If the blank in the following statement is filled by one of the words, *always*, *sometimes*, or *never*, the resulting statement will be true. Write on your answer paper the the word that will correctly complete the statement.
If the diagonals of a quadrilateral are perpendicular to each other and one diagonal bisects the angles through which it is drawn, the quadrilateral is _____ a rhombus. [2]
- 300 1950_01_PG_32e Circles: Tangents
If the blank in the following statement is filled by one of the words, *always*, *sometimes*, or *never*, the resulting statement will be true. Write on your answer paper the the word that will correctly complete the statement.
If to each of two unequal concentric circles a tangent is drawn from point P outside the circles, the tangents are _____ equal. [2]

- 301 1950_01_PG_33 Constructions
It is required to construct a square equal in area to a rhombus whose diagonals are the given line segments d and d' .
- $\overline{\hspace{2cm}d\hspace{2cm}}$
 $\overline{\hspace{2cm}d'\hspace{2cm}}$
- a Representing the side of the square by x , write an equation showing the relationship between x , d and d' . [3]
 b Construct x . [5]
 c Construct the required square. [2]
- 302 1950_06_PG_01 Triangles: Mean Proportionals
In a right triangle the altitude on the hypotenuse is 6. One segment of the hypotenuse is 4. Find the other segment.
- 303 1950_06_PG_02 Polygons: Interior and Exterior Angles of
Find the number of degrees in an exterior angle of a regular polygon of 12 sides.
- 304 1950_06_PG_03 Medians, Altitudes, Bisectors and Midsegments
In triangle ABC , D and E are the midpoints of AB and BC and DE is drawn. Find the ratio of DE to AC .
- 305 1950_06_PG_04 Circles: Chords, Secants and Tangents
Two tangents to a circle from an external point are each 6 inches long and they form an angle of 60° . Find the length of the chord joining their points of contact.
- 306 1950_06_PG_05 Circles: Tangents
Two tangents are drawn to a circle from a point outside the circle.
One of the intercepted arcs is 100° . Find the number of degrees in the angle formed by the two tangents.
- 307 1950_06_PG_06 Trigonometry: Finding Angles
In triangle ABC , angle C is a right angle, $AB = 12$ and $AC = 6$. Find the number of degrees in angle B .
- 308 1950_06_PG_07 Circles: Chords, Secants and Tangents
A tangent and a secant are drawn to a circle from an external point. The secant is 12 and its external segment is 3. Find the length of the tangent.
- 309 1950_06_PG_08 Circles: Chords
Two chords, AB and CD , of circle O intersect at E . If $AE = 5$, $EB = 4$ and $CE = 2$, find ED .
- 310 1950_06_PG_09 Special Quadrilaterals: Rectangles and Squares
Find the length of a diagonal of a rectangle whose sides are 5 and 6. [Answer may be left in radical form.]
- 311 1950_06_PG_10 Circles: Chords
A chord 8 inches long is drawn in a circle whose radius is 5 inches. Find the distance of the chord from the center of the circle.
- 312 1950_06_PG_11 Similarity
Corresponding sides of two similar triangles are in the ratio 1: 4. Find the ratio of a pair of corresponding altitudes.
- 313 1950_06_PG_12 Trigonometry: Finding Sides
If two adjacent sides of a parallelogram are 8 and 10 and the included angle is 45° , find the altitude to side 10. [Answer may be left in radical form.]
- 314 1950_06_PG_13 Triangles: Equilateral
Find the area of an equilateral triangle whose side is 5. [Answer may be left in radical form.]
- 315 1950_06_PG_14 Special Quadrilaterals: Rhombuses
Find the area of a rhombus whose diagonals are 8 and 10.
- 316 1950_06_PG_15 Circles: Center, Radius and Circumference
The circumference of a circle is 12π . Find the radius of the circle.

317 1950_06_PG_16 Circles: Area of
The angle of a sector of a circle is 40° and the radius of the circle is 5. Find the area of the sector.
[Answer may be left in terms of π .]

318 1950_06_PG_17 Using Trigonometry to Find a Side
In isosceles triangle ABC , AB equals BC . Find, to the nearest integer, the length of the altitude to AC if angle $ABC = 96^\circ$ and $AB = 10$.

319 1950_06_PG_18 Medians, Altitudes, Bisectors and Midsegments
If the hypotenuse of a right triangle is 10, find the median to the hypotenuse.

320 1950_06_PG_19 Parallel and Perpendicular Lines
If the blank space in the following statement is replaced by one of the words *always*, *sometimes* or *never*, the resulting statement will be true. Select the word that will correctly complete each statement.
If two parallel lines are cut by a transversal, the bisectors of the two interior angles on the same side of the transversal are _____ perpendicular to each other.

321 1950_06_PG_20 Special Quadrilaterals: Parallelograms
If the blank space in the following statement is replaced by one of the words *always*, *sometimes* or *never*, the resulting statement will be true. Select the word that will correctly complete each statement.
If diagonal AC of quadrilateral $ABCD$ divides it into two congruent triangles, then the quadrilateral is _____ a parallelogram.

322 1950_06_PG_21 Special Quadrilaterals: Rhombuses
If the blank space in the following statement is replaced by one of the words *always*, *sometimes* or *never*, the resulting statement will be true. Select the word that will correctly complete each statement.
If the diagonals of a quadrilateral are unequal and bisect each other at right angles, the quadrilateral is _____ a rhombus.

323 1950_06_PG_22 Locus
The locus of points equidistant from two intersecting lines consists of (a) one point (b) one line (c) two lines

324 1950_06_PG_23 Polygons and Circles: Inscribed
If the center of the circle circumscribed about a triangle lies on one side of the triangle, the triangle is (a) acute (b) right (c) obtuse

325 1950_06_PG_24 Proofs: Circle
To construct a tangent to circle O at point p , a line is drawn perpendicular to OP at point P as shown in the accompanying diagram.

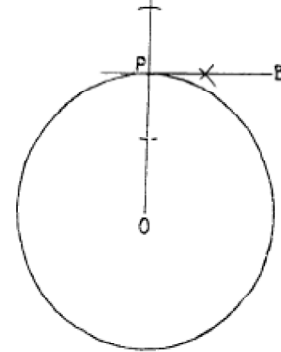

Which of the following statements is the theorem used to prove that BP is tangent to circle O ?

- a A tangent to a circle is a line which has one and only one point in common with the circle.
- b A line perpendicular to a radius at its extremity on the circle is tangent to the circle.
- c A tangent to a circle is perpendicular to the radius drawn to the point of contact.

326 1950_06_PG_25 Constructions
Find by construction the center of the circle of which arc AB is a part.



327 1950_06_PG_26 Proofs: Circle
Prove that a diameter perpendicular to a chord of a circle bisects the chord and its minor arc. [10]

328 1950_06_PG_27 Proofs: Polygon
 $ABCD$ is a parallelogram with F a point on BC . A line through D and F intersects AB extended in E .

a Prove: $\frac{AE}{DC} = \frac{AD}{FC}$ [7]

b Prove: $AE \times FC = AB \times BC$ [3]

329 1950_06_PG_28 Proofs: Polygon
 In parallelogram $ABCD$, AD is longer than DC and diagonal AC is drawn. Prove that AC does not bisect angle C . [10]

330 1950_06_PG_29 Proofs: Polygon
 Prove that the area of a trapezoid is equal to one-half the product of its altitude and the sum of its bases. [10]

331 1950_06_PG_30 Circles: Chords, Secants and Tangents
 In the accompanying diagram, AB is a diameter of circle O and FG is the tangent at point C . Arc BC \equiv 1000 and arc BE \equiv 30° . Find the number of degrees in each of the angles 1, 2, 3, 4 and 5. [10]

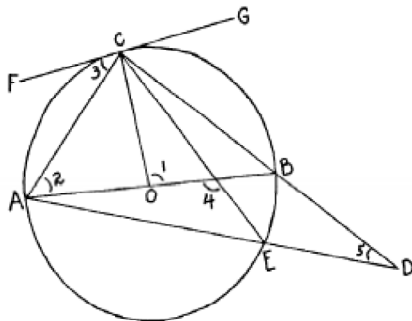

332 1950_06_PG_31 Trigonometry: Finding Sides Using Two Triangles
 In the diagram at the right P represents a point 310 feet from the foot of a vertical cliff BC . AB is a flagpole standing on the edge of the cliff. At P the angle of elevation of B is 21° and of A is 25° .

Find, to the nearest foot,

a the distance AC [4]

b the length of the flagpole AB [6]

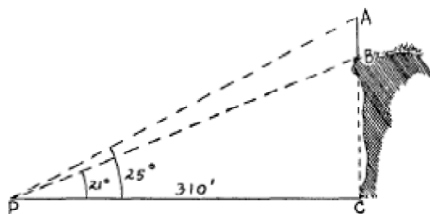

333 1950_06_PG_32 Proofs: Triangle
 From any point P in the base AC of triangle ABC lines are drawn to R and S , the midpoints of AB and BC respectively. Perpendiculars from R and S to AC are drawn.

a Prove that these perpendiculars are equal.

[4]

b Prove that the area of triangle ARP plus the area of triangle CSP equals one-half the area of triangle ABC . [6]

334 1950_06_PG_33 Polygons and Circles: Inscribed
 A design in the shape of a regular hexagon inscribed in a circle is to be made from a piece of wire 86 inches long. The wire is to be cut into two pieces such that one piece may be used to form the hexagon and the other to form the circle.

a If x represents the radius of the circle, write an equation which can be used to find x . [5]

b Using $\pi = \frac{22}{7}$, find the length of each part of the wire. [5]

335 1950_08_PG_01 Triangles: Interior and Exterior Angles of
 The vertex angle of an isosceles triangle is 80° . Find the number of degrees in an exterior angle formed by extending the base.

336 1950_08_PG_02 Triangles: Mean Proportionals
 The altitude upon the hypotenuse of a right triangle divides the hypotenuse into segments of 9 and 16. Find the length of the altitude.

337 1950_08_PG_03 Circles: Chords, Secants and Tangents
 If two secants drawn to a circle from the same external point intercept arcs of 120° and 50° on the circle, find the number of degrees in the angle formed by the secants.

338 1950_08_PG_04 Triangles: Equilateral
 Find the area of an equilateral triangle whose side is 8. [Answer may be left in radical form.]

339 1950_08_PG_05 Polygons and Circles: Inscribed
 A square is circumscribed about a circle whose diameter is 8 inches. Find the area of the square.

- 340 1950_08_PG_06 Special Quadrilaterals: Parallelograms
In parallelogram $ABCD$, angle B is 30° larger than angle A . Find the number of degrees in angle A .
- 341 1950_08_PG_07 Special Quadrilaterals: Rhombuses
The diagonals of a rhombus are 18 and 24. Find a side of the rhombus.
- 342 1950_08_PG_08 Circles: Chords, Secants and Tangents
Secant ABC and tangent AD are drawn to a circle from an external point A . Chord $BC = 12$ inches and $AB = 4$ inches. Find the length of tangent AD .
- 343 1950_08_PG_09 Circles: Chords
Two chords AB and CD of a circle intersect in E . If $AE = 4$, $EB = 6$ and $CE = 8$, find ED .
- 344 1950_08_PG_10 Proofs: Triangle
In triangle ABC , DE which is parallel to BC cuts AB in D and AC in E .
If $AD = 15$ inches, $DB = 12$ inches and $EC = 8$ inches, find the length of AE .
- 345 1950_08_PG_11 Polygons: Area of
Find the area of a trapezoid whose bases are 10 feet and 8 feet and whose altitude is 6 feet.
- 346 1950_08_PG_12 Polygons: Interior and Exterior Angles of
If the sum of the interior angles of a polygon is 900° , find the number of sides of the polygon.
- 347 1950_08_PG_13 Circles: Center, Radius and Circumference
Find the radius of a circle if the area of a 90° sector of that circle is 25π square inches.
- 348 1950_08_PG_14 Circles: Arc Measure
Find the length of an arc of 120° in a circle whose radius is 9 feet.
[Answer may be left in terms of $7r$.]
- 349 1950_08_PG_15 Trigonometry: Finding Sides
In triangle ABC , angle $C = 90^\circ$, $AB = 15$ inches and angle $A = 38^\circ$. Find AC to the nearest inch.
- 350 1950_08_PG_16 Circles: Chords, Secants and Tangents
From a point P outside circle O , PO and tangent PT are drawn.
If radius $OT = 5$ and $OP = 10$, how many degrees are there in angle OPT ?
- 351 1950_08_PG_17 Similarity
The areas of two similar triangles are in the ratio 4:1. If a side of the larger triangle is 8 inches, find the length of the corresponding side of the smaller triangle.
- 352 1950_08_PG_18 Medians, Altitudes, Bisectors and Midsegments
If the altitudes of a triangle intersect in a point which is outside the triangle, the triangle is (a) acute (b) right (c) obtuse
- 353 1950_08_PG_19 Polygons: Interior and Exterior Angles of
As the number of sides of a regular polygon increases, each exterior angle of the polygon (a) increases (b) decreases (c) remains the same
- 354 1950_08_PG_20 Circles: Chords
If in a circle chords AB and CD are perpendicular to each other, then (a) arc $AC = 90^\circ$ (b) arc $AC =$ arc BD (c) the sum of arc AC and arc BD is 180°
- 355 1950_08_PG_21 Locus
The locus of the centers of circles tangent to both of two given parallel lines is (a) a point (b) a line (c) two lines
- 356 1950_08_PG_22 Proofs: Triangle
In circles O and O' , radii OA , DB , $O'A'$, $O'B'$ are drawn making angle $AOB =$ angle $A'O'B'$. If AB and $A'B'$ are drawn, then triangle AOB and triangle $A'O'B'$ must be (a) congruent (b) similar (c) equal in area

- 357 1950_08_PG_23 Logical Reasoning: Converse
John attends a certain school in which every member of the chess team is a good mathematics student. Which of the following conclusions is an example of reasoning from a converse?
(a) John is a good mathematics student. Therefore he is a member of the chess team.
(b) John is not a good mathematics student. Therefore he is not a member of the chess team.
(c) John is a member of the chess team. Therefore he is a good mathematics student. 23 .

- 358 1950_08_PG_24 Constructions
Inscribe an equilateral triangle in circle O.

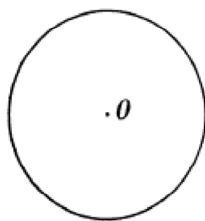

- 359 1950_08_PG_25 Constructions
Divide line segment AB into two segments having the ratio 2: 3.



- 360 1950_08_PG_26 Proofs: Triangle
Prove that the sum of the angles of a triangle is a straight angle. [10]

- 361 1950_08_PG_27
Quadrilateral $ABCD$ is inscribed in a circle. Side AD is equal to side BC . Straight lines are drawn from EJ the mid-point of side ABJ to D and C .
a Prove arc $ADC =$ arc BCD [3]
b Prove $DE = CE$ [7]

- 362 1950_08_PG_28 Proofs: Triangle
In triangle ABC , angle C is a right angle, and D is a point on AC . With AD as the diameter, a circle is drawn cutting AB in E . Prove $AB \times AE = AC \times AD$. [10]

- 363 1950_08_PG_29 Proofs: Polygon
Prove that the area of a trapezoid is equal to one-half the product of its altitude and the sum of its bases. [10]

- 364 1950_08_PG_30 Circles: Center, Radius and Circumference
A circular fish pond is 38 feet in circumference. It is to be surrounded by a stone walk 4 feet wide.
a Find the radius of the pond to the nearest foot. [3]
b Using the value found in answer to a , find, to the nearest dollar, the cost of constructing the walk at 45 cents a square foot. [7]

- 365 1950_08_PG_31 Trigonometry: Law of Cosines
In triangle ABC , AD is the altitude to base BC . $AB = 25$ feet, $AC = 26$ feet and $\angle B = 74^\circ$
a Find AD to the nearest foot. [3]
b Find, to the nearest square foot, the area of triangle ABC . [7]

- 366 1950_08_PG_32a Polygons: Area of
If the blank space in the following statement is filled by one of the words *always*, *sometimes*, or *never*, the resulting statement will be true. Write on your answer paper the word that will correctly complete the corresponding statement.
The areas of two regular polygons _____ have the same ratio as the squares of the corresponding sides. [2]

- 367 1950_08_PG_32b Polygons and Circles: Inscribed
If the blank space in the following statement is filled by one of the words *always*, *sometimes*, or *never*, the resulting statement will be true. Write on your answer paper the word that will correctly complete the corresponding statement.
If a parallelogram is inscribed in a circle, its diagonals are _____ equal. [2]

368 1950_08_PG_32c Medians, Altitudes, Bisectors and Midsegments

If the blank space in the following statement is filled by one of the words *always*, *sometimes*, or *never*, the resulting statement will be true. Write on your answer paper the word that will correctly complete the corresponding statement.

BD is a median of triangle ABC . If angle BDC is greater than angle BDA , BC is _____ greater than AB . [2]

369 1950_08_PG_32d Triangles: Mean Proportionals

If the blank space in the following statement is filled by one of the words *always*, *sometimes*, or *never*, the resulting statement will be true. Write on your answer paper the word that will correctly complete the corresponding statement.

The altitude to the hypotenuse of a right triangle is _____ the mean proportional between the legs of the right triangle. [2]

370 1950_08_PG_32e Medians, Altitudes, Bisectors and Midsegments

If the blank space in the following statement is filled by one of the words *always*, *sometimes*, or *never*, the resulting statement will be true. Write on your answer paper the word that will correctly complete the corresponding statement.

In triangle ABC , D is a point on side AB and E is a point on side BC . If $DE = \frac{1}{2}AC$, then DE is _____ parallel to AC . [2]

371 1950_08_PG_33 Proofs: Triangle

Regular hexagon $ABCDEF$ is inscribed in a circle. Diagonals FB and FD intersect diagonal AE in G and H respectively.

a Prove that triangle FGH is an equilateral triangle. [3]

b Prove that $AG = GH = HE$ [5]

c If GH is 6 inches long, find the area of triangle APE . [Answer may be left in radical form.] [2]

PT - Plane Trigonometry (1890-1930)

- 1 1890_01_PT_01 Logarithms
Explain the difference between the characteristic and mantissa of the logarithm of a whole number and that of a decimal fraction.
- 2 1890_01_PT_02 Logarithms
The logarithm of 199 is 2.298853. Find the logarithm of the fourth power of 199, and also of its cube root and state the principles employed.
- 3 1890_01_PT_03 Trigonometric Functions: Properties of
Draw a figure of the fourth quadrant and upon it indicate the following functions of 300° ; sine, cosine, cotangent, secant.
- 4 1890_01_PT_04 Trigonometry: Law of Cosines
State and demonstrate the theorem employed in comparing the remaining angles of a triangle when two sides and the included angle are given.
- 5 1890_01_PT_05 Trigonometric Ratios: Basic
Given the versed sine $= \frac{2}{3}$, find the values of the sine, cosine, and tangent.
- 6 1890_01_PT_06 Proofs: Trigonometric
Prove that $\cos(a-b) = \cos a \cos b + \sin a \sin b$.
- 7 1890_01_PT_07 Proofs: Trigonometric
Assuming the value of the functions of the sum and of the difference of two arcs, prove that:
a. $\cos \frac{1}{2} a = \pm \frac{\sqrt{1 + \cos a}}{2}$
b. $\sin p - \sin q = 2 \sin \frac{1}{2} (p - q) \cos \frac{1}{2} (p + q)$
- 8 1890_01_PT_08 Trigonometric Ratios: Basic
In a right handed triangle, given the hypotenuse and an acute angle; state the formulae for finding the remaining parts.
- 9 1890_01_PT_09 Trigonometry: Finding Sides
Explain, by means of a diagram, what measurements and what computations are necessary to determine, trigonometrically, the distance between two inaccessible objects, both of which can be seen from no one point.
- 10 1890_03_PT_01 Definitions: Trigonometry
Define trigonometry: complementary angles, mantissa and characteristic of a logarithm. What is the significance of a negative characteristic?
- 11 1890_03_PT_02 Trigonometric Functions: Properties of
Illustrate geometrically the following functions of arcs: $\sin 90^\circ$; $\cos 180^\circ$; \tan and $\operatorname{cosec} 45^\circ$; and clearly indicate each.
- 12 1890_03_PT_03 Logarithms
The log. of 2 is .30103, and the log. of 3 is .47713. Find the log. of 144.
- 13 1890_03_PT_04 Trigonometric Functions: Evaluating
Given the $\cos = \frac{1}{3}$. Find the values of \sin , \tan , and \cot .
- 14 1890_03_PT_05 Proofs: Trigonometric
Prove that $\sin(a + b) = \sin a \cos b + \cos a \sin b$.
- 15 1890_03_PT_06 Proofs: Trigonometric
By means of fundamental formulas prove that:
a. $\cot x + \tan y = \frac{\cos(x - y)}{\sin x \cos y}$
b. $\tan(a + b) = \frac{\tan a + \tan b}{1 - \tan a \tan b}$
- 16 1890_03_PT_07 Trigonometry: Law of Sines
Prove that in any plane triangle the sines of the angles are proportional to the opposite sides.

- 17 1890_03_PT_08 Medians, Altitudes, Bisectors and Midsegments
How can the perpendicular from one angle to the opposite side be found, in any plane triangle?
- 18 1890_03_PT_09 Trigonometry: Law of Cosines
In an oblique triangle, ABC, given a , b , and angle C, state formulas for finding the remaining parts and the area of the triangle.
- 19 1890_03_PT_10 Circles: Chords, Secants and Tangents
The diameter of the earth being taken as 7912 miles, what is the distance of the remotest point of the surface visible from the summit of a mountain $1\frac{1}{4}$ miles in height? Draw a figure and explain as fully as possible with formulas, how the problem should be solved.
- 20 1890_06_PT_01 Definitions: Trigonometry
Define trigonometry; logarithm; logarithmic sine; complement of an angle.
- 21 1890_06_PT_02 Trigonometric Graphs
Trace the changes in sign and magnitude of $\tan A$ as A increases from 0° to 360° . Illustrate with diagram.
- 22 1890_06_PT_03 Logarithms
 $\log 8 = .90309$; $\log 12 = 1.07918$. What is the log of $\frac{2}{3}$?
- 23 1890_06_PT_04 Trigonometric Ratios: Basic
Find by geometric principles the \sin , \tan , and \sec , of 45° and show their relations to the \cos , \cot , and cosec of the same angle.
- 24 1890_06_PT_05 Trigonometric Identities: Angle Sum or Difference
Complete the following equations:
(a) $\sin (a+b) =$
(b) $\cos (a+b) =$
(c) $\sin (a-b) =$
(d) $\cos (a-b) =$
- 25 1890_06_PT_06 Proofs: Trigonometric
Prove equation (b) in the last question.

NOTE: The following problem is referred to:
1890_06_PT_05
Complete the following equations:
(a) $\sin (a+b) =$
(b) $\cos (a+b) =$
(c) $\sin (a-b) =$
(d) $\cos (a-b) =$
- 26 1890_06_PT_07 Proofs: Trigonometric
Prove
(a) $\cot 2a = \frac{\cot^2 a - 1}{2 \cot a}$
(b) $\sin p + \sin q = 2 \sin \frac{1}{2} (p + q) \cos \frac{1}{2} (p - q)$
- 27 1890_06_PT_08 Trigonometry: Law of Cosines
State and demonstrate the theorem employed in solving a triangle of which the three sides are given.
- 28 1890_06_PT_09 Trigonometry: Finding Sides
Required the height of a wall whose angle of elevation, at a distance of 463 feet, is observed to be $16^\circ 21'$. Give the formulas for the solution.
- 29 1890_06_PT_10 Constructions
Explain by means of a diagram how to determine the distance between the summits of two towers seen from the opposite side of a river.
- 30 1900_01_PT_01 Circles: Center, Radius and Circumference
Find the radius of a circle if an arc 6 inches long subtends at the center an angle of 15 degrees.
- 31 1900_01_PT_02 Trigonometric Ratios: Basic
Find the algebraic sign and the numeric value of each of the following: $\cos 135^\circ$, $\sec 210^\circ$, $\tan 150^\circ$, $\operatorname{csc} 120^\circ$, $\operatorname{ctn} 225^\circ$.

- 32 1900_01_PT_03_04 Trigonometric Graphs
Given $\tan A = -\frac{20}{21}$ and A in the fourth quadrant;
represent graphically five other functions of A and
find the algebraic sign and the numeric value of
each.
- 33 1900_01_PT_05 Logarithms
Complete and demonstrate the following: a) the
logarithm of a quotient is equal to ..., b) the
logarithm of a root is equal to
- 34 1900_01_PT_06 Trigonometric Identities
Find $\cos 3x$ in terms of $\cos x$
- 35 1900_01_PT_07 Proofs: Trigonometric
Prove $\tan(A - B) = \frac{\tan A - \tan B}{1 + \tan A \tan B}$
- 36 1900_01_PT_08 Trigonometry: Law of Cosines
Prove that the square of any side of a triangle is
equal to the sum of the squares of the other two
sides diminished by twice the product of those sides
into the cosine of the included angle.
- 37 1900_01_PT_09 Trigonometric Equations
Given $\sin 2x - \cos x = \cos^2 x$, find x .
- 38 1900_01_PT_10 Trigonometry: Finding Angles
A vertical pole, 60 feet high, standing on level
ground, casts a shadow 53 feet 3 inches long; find
the angle of elevation of the sun above the horizon.
- 39 1900_01_PT_11 Trigonometry: Finding Sides Using Two
Triangles
The deck of a ship is on a level with a wharf; from
a point on the wharf the angle of elevation of the
top of the ship's mainmast is 28° ; in a line with this
point and the mast, and 100 feet further from the
ship, the angle of elevation is $20^\circ 28'$. Find the
height of the mast.
- 40 1900_01_PT_12_13 Trigonometry: Finding Area
ABCD is a quadrilateral; the length of AB is 12
rods, of BC 15 rods, of CD 22 rods, and of DA 9
rods; C is an angle of $54^\circ 40'$. Find the area of the
quadrilateral.
- 41 1900_01_PT_14_15 Trigonometry: Finding Sides
From a window, A, 100 feet above the level of a
street, the angle of depression of the two ends of the
street, B and C, are $36^\circ 50'$ and $18^\circ 30'$ respectively;
BAC is an angle of $83^\circ 15'$. Find the length of
street BC.
- 42 1900_06_PT_01 Definitions: Trigonometry
Define each of the following a) as a ratio, b) as a
line: sine, cosine, tangent, cotangent, secant.
- 43 1900_06_PT_02 Trigonometric Ratios: Basic
Derive, without the use of the tables, the numeric
value of each of the following: $\sin 30^\circ$, $\cos 150^\circ$,
 $\tan 225^\circ$, $\sec 120^\circ$, $\csc 300^\circ$.
- 44 1900_06_PT_03 Trigonometric Functions: Properties of
Write in tabular form the signs of the following for
each of the four quadrants: sine, cosine, cotangent,
secant.
- 45 1900_06_PT_04 Trigonometric Identities: Double and Half
Angle
Assuming the values of $\sin(x+y)$ and $\cos(x+y)$,
find the values of $\sin 2x$, $\cos 2x$, $\tan 2x$ and $\csc 2x$.
- 46 1900_06_PT_05 Proofs: Trigonometric
Prove that in any triangle $\cos A = \frac{b^2 + c^2 - a^2}{2bc}$
- 47 1900_06_PT_06 Logarithms
Prove that the mantissa of a logarithm of the
number represented by any sequence of figures is
independent of the position of the decimal point.
- 48 1900_06_PT_07 Trigonometric Ratios: Basic
In a right triangle, given $c=256$ feet, $A = 39^\circ 42'$;
find the remaining parts.
- 49 1900_06_PT_08_09 Trigonometry: Law of Sines
Given $A=32^\circ$, $a = 60$ feet, $b=80$ feet; find the
remaining parts. [Give two solutions.]
- 50 1900_06_PT_10_11 Trigonometry: Law of Cosines
Given $a=65$ feet, $b=72$ feet, $c=115$ feet; find the
three angles.

- 51 1900_06_PT_12_13 Trigonometry: Law of Sines
A surveyor on a point A on the bank of a river wishes to find the distance across the stream to the point B ; he measures AC a distance of 200 feet on the bank of the stream and finds that angle $BAC=110^{\circ}30'$ and angle $BCA=42^{\circ}25'$. Find AB .
- 52 1900_06_PT_14_15 Trigonometry: Finding Area
 AB , BC , CD , and DA , the sides of a field, are 40 rods, 65 rods, 27 rods and 70 rods respectively; the angle C is $84^{\circ}30'$. Find the area of the field.
- 53 1920_01_PT_01 Proofs: Trigonometric
 a Prove $\frac{1 - \sin A}{1 + \sin A} = (\sec A - \tan A)^2$
 b Prove without using the tables:
 $\frac{\sin 75^{\circ} + \sin 15^{\circ}}{\sin 75^{\circ} - \sin 15^{\circ}} = \sqrt{3}$
- 54 1920_01_PT_02 Equations: Logarithmic
 a Compute the value of

$$\sqrt[n]{\frac{(5.162)(0.0913)^2}{10.132}}$$

 b Solve the value of x : $\log\left(\frac{1}{x}\right)^2 = 3$
- 55 1920_01_PT_03 Trigonometric Functions: Properties of
 a Find the numerical values of the following:
 $\cos 240^{\circ}$; $\cot 750^{\circ}$; $\sin(-225)^{\circ}$; $\tan 540^{\circ}$
 b Why can the value of the sine of an angle never be greater than 1?
 c Why is there no limit to the value of the tangent of an angle?
- 56 1920_01_PT_04 Trigonometric Equations
Solve for values less than 360° and check:
 $\sin^2 x - \cos x = \frac{1}{4}$
- 57 1920_01_PT_05 Trigonometry: Law of Cosines
In the triangle ABC , $a = 22.531$, $b = 34.645$, $C = 43^{\circ}31'$. Find A , B , and c .
- 58 1920_01_PT_06 Polygons and Circles: Inscribed
Find the perimeter and the area of a regular decagon circumscribed about a circle whose radius is 12 units.
- 59 1920_01_PT_07 Trigonometry: Finding Sides Using Two Triangles
To find the height of an inaccessible object a horizontal base line CD , 250 feet long, is measured directly toward the foot A of the object AB ; the angles of elevation $ADB=48^{\circ}20'$, and $ACB=38^{\circ}40'$. Find the height AB .
- 60 1920_01_PT_08 Trigonometry: Finding Sides Using Two Triangles
 A and B are 1 mile apart on a straight road and C is a distant object on the same horizontal plane. The angles ABC and BAC are observed to be 120° and 45° respectively. Show (without the use of tables) that the distance from A to C is approximately 3.346 miles.
- 61 1920_06_PT_01a Trigonometric Identities: Angle Sum or Difference
 a If $\tan A = \frac{a}{a+1}$ and $\tan B = \frac{1}{2a+1}$ prove that $\tan(A+B) = 1$
- 62 1920_06_PT_01b Trigonometric Equations
Solve the equation
 $2 \cos^2 A = 1 - \sin A$
 for all values of A from 0° to 360° .
 Check the largest angle found.
- 63 1920_06_PT_02 Proofs: Trigonometric
Prove the identity $\frac{\cos 2x}{1 + \sin 2x} = \frac{\cot x - 1}{\cot x + 1}$
- 64 1920_06_PT_03a Trigonometric Functions: Evaluating
Without the use of tables, find the value of $\sin 15^{\circ}$, leaving the answer in radical form.
- 65 1920_06_PT_03b Logarithms
By the use of logarithms find the value of

$$\frac{0.076 \times \sqrt[3]{57.46}}{(2.34)^2}$$

- 66 1920_06_PT_04 Trigonometric Identities: Double and Half Angle
If the angle A lies between 180° and 270° and $\tan A = \frac{5}{12}$,
(a) find $\sin A$ and $\cos A$,
(b) using values found in the answer to (a) find $2A$ and $\cos \frac{A}{2}$
- 67 1920_06_PT_05a Trigonometric Identities
Show that $\frac{\sin 2A - \sin A}{\cos A - \cos 2A} = \cot \frac{3A}{2}$
- 68 1920_06_PT_05b Equations: Logarithmic
Solve for x : $7^{2x+3} = 43$
- 69 1920_06_PT_06 Trigonometry: Law of Sines - The Ambiguous Case
In *each* of the following triangles state the number of solutions and show in full on your paper the reason for your conclusion in each case:
(1) $b=75.3$ $a=49.7$
 $A=40^\circ$
(2) $a=67.4$ $b=97.6$
 $c=30.2$
(3) $c=156.3$ $b=104.8$
 $B=142^\circ$
(4) $a=56.7$ $b=38.4$
 $A=58^\circ 20'$
(5) $a=18.0$ $c=9.0$
 $C=30^\circ$
- 70 1920_06_PT_07 Trigonometry: Finding Sides Using Two Triangles
From the top of a lighthouse 257 feet above the sea, the angles of depression to two boats, in line with the lighthouse, are observed to be 14° and 32° respectively; find the distance between the two boats.
- 71 1920_06_PT_08 Trigonometry: Law of Cosines
Given $a=71.2$, $b=64.8$, $c=37$; find all the angles of the triangle.
- 72 1920_06_PT_09 Trigonometry: Law of Sines
The longer diagonal of a parallelogram is 500 feet and the angles it makes with the sides are $46^\circ 36'$ and $10^\circ 12'$; find the lengths of the sides and the area of the parallelogram.
- 73 1920_09_PT_01 Trigonometry: Finding Area
If n represents one side of a regular pentagon, show that the area is $\frac{3}{4} n^2 \tan 54^\circ$.
- 74 1920_09_PT_02 Trigonometric Functions: Evaluating
If $A = 18^\circ$, then $\sin 3A - \sin(90 - 2A) = \cos 2A$. Expanding both sides of this equation and solving for $\sin A$, find, without using the tables, the value of $\sin 18^\circ$ expressed as a decimal.
- 75 1920_09_PT_03 Logarithms
Find by the use of logarithms the value
of $\sqrt{\frac{(-.00326)^2 \times 321.38^3}{2.3017}}$
- 76 1920_09_PT_04 Trigonometric Equations
Without the use of tables, find all possible values of A between 0° and 360° that satisfy the equation $2\sqrt{3} \cos^2 \theta = \sin \theta$
- 77 1920_09_PT_05 Trigonometric Identities: Double and Half Angle
If $\tan 2x = \frac{24}{7}$ find $\tan x$ and $\sin x$ when it is known that x is an angle in the third quadrant.
- 78 1920_09_PT_06 Trigonometry: Finding Sides Using Two Triangles
An observer standing on the bank of a river notes that the angle subtended by a flagpole on the opposite bank is $33^\circ 10'$; when he retires 120 feet from the bank he finds the angle to be $18^\circ 16'$. Find the width of the river.
- 79 1920_09_PT_07 Trigonometry: Law of Sines
Solve the triangle ABC when $C=104^\circ 13' 48''$, $b=115.72$, $c=165.28$

- 80 1920_09_PT_08 Triangles: Vectors
A man in a railway car going 45 miles an hour observes the rain drops falling at an angle of 10° with the horizontal; assuming that the rain drops are actually falling vertically, find their speed.
- 81 1930_01_PT_01 Trigonometric Functions: Properties of
Complete the following statement: The sine or cosine of any angle is never greater than _____
- 82 1930_01_PT_02 Trigonometry: Law of Cosines
Complete the formula $c^2 = a^2 + b^2$ _____, so that it will express the law of cosines.
- 83 1930_01_PT_03 Trigonometry: Law of Sines
In triangle ABC , $\sin A = 1/2$, $\sin B = 1/3$ and $b = 6$; find a .
- 84 1930_01_PT_04 Trigonometric Functions: Evaluating
Find *two* positive values of x less than 360° when $\sin x = \csc x$
- 85 1930_01_PT_05 Trigonometry: Reference Angles
Express $\cos 350^\circ$ as a function of a positive angle less than 90° .
- 86 1930_01_PT_06 Trigonometric Functions: Evaluating
When $\sin A = \frac{2}{3}$ and A is in the first quadrant, find $\cot A$. [Leave answer in radical form.]
- 87 1930_01_PT_07 Circles: Radian Measure
Reduce $14^\circ 20'$ to radians.
- 88 1930_01_PT_08 Trigonometric Ratios: Basic
Given a right triangle whose sides are 5, 12 and 13; express as a common fraction the sine of the smallest angle.
- 89 1930_01_PT_09 Trigonometric Functions: Inverses of
Find $\cos y$ if $y = \sin^{-1} \frac{3}{5}$
- 90 1930_01_PT_10 Trigonometry: Law of Sines
In a right triangle, $\sin A = \frac{5}{12}$ and $c = 72$; find a .
- 91 1930_01_PT_11 Trigonometric Identities
Write the formula for $\sin 2A$ in terms of $\sin A$ and $\cos A$.
- 92 1930_01_PT_12 Trigonometry: Finding Sides
A ship sails directly northwest at the rate of 20 miles an hour. How many miles north of the starting point will the ship be at the end of one hour? [Give the answer to the *nearest mile*.]
- 93 1930_01_PT_13 Trigonometric Ratios: Basic
Find $\cos 42^\circ 15' 20''$
- 94 1930_01_PT_14 Trigonometric Functions: Inverses of
Given $\sin x = 0.6194$; find x in degrees and minutes to the *nearest minute*.
- 95 1930_01_PT_15 Logarithms of Trigonometric Functions
Find $\log \tan 56^\circ 48' 15''$
- 96 1930_01_PT_16 Trigonometric Functions: Inverses of
Given $\log \cos A = 9.82898 - 10$; find A in degrees, minutes, and seconds.
- 97 1930_01_PT_17
A 50-foot vertical pole casts a shadow 30 feet long; find to the *nearest minute* the angle of elevation of the sun.
- 98 1930_01_PT_18 Trigonometry: Law of Cosines
In an isosceles triangle, each of the equal sides is 40 and the altitude to the third side is 16; find to the *nearest minute* one of the equal angles.
- 99 1930_01_PT_19
A troop of Boy Scouts wish to know the distance BC across a pond. They lay off a straight line perpendicular to BC at C and extend it 400 feet to A from which point B is visible. Angle BAC is 64° . Find to the *nearest foot* the distance across the pond.

100 1930_01_PT_20 Trigonometry: Finding Area
In a triangle, $a = 40$, $c = 50$, and $B = 58^\circ$; find the area of the triangle.

101 1930_01_PT_21 Trigonometry: Law of Cosines
Two sides of a parallelogram are 12 and 16 and the included angle is $64^\circ 12'$; find the shorter diagonal. [12 ½]

102 1930_01_PT_22 Trigonometry: Finding Sides Using Two Triangles
A flagpole 30 feet high stands on the top of a vertical cliff whose base forms a part of the shore of a lake. From a boat the angle of elevation of the top and bottom of the pole are 61° and 45° respectively. Find the height of the cliff to the nearest foot. [12 ½]

103 1930_01_PT_23 Trigonometry: Finding Sides Using Two Triangles
A captive balloon rests directly above a straight horizontal road. At two points on the road which are 2000 feet apart and on opposite sides of the balloon, the angles of elevation of the balloon are 46° and 59° . Find the height of the balloon. [12 ½]

104 1930_01_PT_24a Trigonometric Formulas: Derivations of
Derive the formula for $\tan(x - y)$, starting with the formula for $\sin(x - y)$ and $\cos(x - y)$ [7]

105 1930_01_PT_24b Trigonometric Identities: Double and Half Angle
Given $\sin \frac{3}{5}$, A being a positive acute angle; find $\tan \frac{1}{2}A$, using the formula for the tangent of half an angle. [5 ½]

106 1930_01_PT_25 Proofs: Trigonometric
Prove that triangle ABC is isosceles if $b \cos A = a \cos B$ [7 ½]

107 1930_01_PT_26 Trigonometric Graphs
a Complete the following table, using natural sines: [5 ½]

x	0°	30°	60°	90°	120 °	150 °	180 °
$\sin x$	0	.50					

b Plot the graph of $y = \sin x$, using the data shown in the table completed in answer to a. [5]

c What does the graph made in answer to b show regarding $\sin x$ as x increases from 0° to 90° ? From 90° to 180° ? [1,1]

108 1930_06_PT_01 Trigonometry: Reference Angles
Express $\tan(-263^\circ)$ as the tangent of a positive angle less than 90° .

109 1930_06_PT_02 Trigonometric Functions: Logarithms of
Find $\log \tan 82^\circ 17' 41''$

110 1930_06_PT_03 Trigonometric Functions: Evaluating
Find the value of $\cos 63^\circ 20' 24''$

111 1930_06_PT_04 Trigonometric Functions: Logarithms of
Given $\log \cot A = 9.67569 - 10$; find A in degrees, minutes and seconds.

112 1930_06_PT_05 Trigonometric Functions: Inverses of
Given $\sin B = .1686$; find B in degrees and minutes.

113 1930_06_PT_06 Trigonometric Functions: Inverses of
If A is in the first quadrant and $A = \tan^{-1} \frac{5}{12}$, find $\sin 2A$.

- 114 1930_06_PT_07 Trigonometric Functions: Properties of
If $\cos A$ is negative and $\tan A$ is positive, may A be an angle of a triangle? [Answer *yes* or *no*.]
- 115 1930_06_PT_08 Trigonometric Functions: Evaluating
Given $\tan x = 2 \sin x$; find *two* values of x between 0° and 360° .
- 116 1930_06_PT_09 Trigonometric Equations
Which of the three values, 30° , 60° , 45° , is a solution of the equation $\sin^2 x - \cos x = \frac{1}{4}$?
- 117 1930_06_PT_10 Trigonometric Equations
Find the smallest positive value of x for which $4^{\sin x} = 2$
- 118 1930_06_PT_11 Trigonometric Functions: Properties of
Sine x increases more rapidly as x increases from 85° to 90° than when x increases from 0° to 5° . [Mark *true* or *false*.]
- 119 1930_06_PT_12 Circles: Radian Measure
How many angle degrees in $\frac{7\pi}{8}$ radians?
- 120 1930_06_PT_13 Trigonometric Ratios: Cofunction and Reciprocal
The sine is the reciprocal of what function?
- 121 1930_06_PT_14 Trigonometric Identities: Double and Half Angle
Express $\cos 2x$ in terms of $\sin x$.
- 122 1930_06_PT_15 Trigonometry: Finding Sides
How far from a tree 30 feet high must a person lie in order to see the top of the tree at an angle of elevation of 50° ?
- 123 1930_06_PT_16 Trigonometry: Finding Angles
A rectangle with base 7.5 inches long has a diagonal 8.2 inches long; what angle does the diagonal make with the base?
- 124 1930_06_PT_17 Trigonometry: Law of Sines - The Ambiguous Case
How many different triangles may be formed in which $a = 80$, $b = 100$ and $A = 30^\circ$?
- 125 1930_06_PT_18 Special Quadrilaterals
In a parallelogram, the base is b , the acute angle at the base is x and the area is K ; find the side adjacent to b in terms of b , x and K .
- 126 1930_06_PT_19 Polygons and Circles: Inscribed
What is the length of a side of a regular pentagon inscribed in a circle whose radius is 10?
- 127 1930_06_PT_20 Trigonometry: Law of Cosines
Two sides of a triangle are 4 and 6 and the included angle is 60° ; what is the third side? [Leave answer in radical form.]
- 128 1930_06_PT_21 Trigonometry: Law of Cosines
The length of a pond subtends at a certain point an angle of $40^\circ 36'$. The distances from this point to the two ends of the pond are 1228 feet and 1876 feet. Find the length of this pond. [12 ½]
- 129 1930_06_PT_22 Trigonometry: Finding Sides Using Two Triangles
A person on the bank of a river observes that the elevation of the top of a tree on the opposite bank is $47^\circ 20'$. He then walks back from the river 50 feet in a direct line from the tree and observes that the elevation of the top of the tree at this point is $44^\circ 35'$. How wide is the river? [12½]
- 130 1930_06_PT_23 Trigonometry: Finding Angles
 $ABCD$ is a parallelogram, side $AB = 329$, side $AD = 578$ and diagonal $AC = 627$; find angle DAB . [12½]
- 131 1930_06_PT_24 Proofs: Trigonometric
a Starting with the law of sines for a triangle ABC , derive the law of tangents. [6½]
b Prove that $\sin(30^\circ + x) + \sin(30^\circ - x) = \cos x$ [4]
c Find the value of $\cos^{-1} \frac{1}{2} + \tan^{-1} 1$, when each angle is in the first quadrant. [2]

- 132 1930_06_PT_25a Trigonometric Equations
Find to the *nearest minute* the positive acute angle that satisfies the equation $4 \cos 2x + 3 \cos x = 1$ [7½]
- 133 1930_06_PT_25b Proofs: Trigonometric
Prove: $\cos^4 x - \sin^4 x = \cos 2x$ [5]
- 134 1930_06_PT_26 Trigonometric Graphs
a Construct a table of values for $2 \sin x$ for intervals of 30° as x varies from 0° to 360° . [4]
b Plot the graph of $y = 2 \sin x$ [5]
c Place on the graph a label A to indicate the point used in finding the value of y when $x = 20^\circ$ [1]
d From the graph made in answer to b , determine values of x that will make y equal to 1.5. [2½]
- 135 1930_08_PT_01 Trigonometric Functions: Properties of
What kind of triangle is ABC if the cosine of one of its angles is negative?
- 136 1930_08_PT_02 Trigonometric Ratios: Cofunction and Reciprocal
In a right triangle ABC , $\sec A = y$; express $\csc B$ in terms of y .
- 137 1930_08_PT_03 Trigonometry: Law of Tangents
What does $\frac{c-b}{c+b}$ equal in terms of angles C and B in the formula that expresses the law of tangents?
- 138 1930_08_PT_04 Trigonometric Functions: Evaluating
Find the value of $\sin(-135^\circ) + \cos 45^\circ$
- 139 1930_08_PT_05 Trigonometric Equations
Find a positive value of x less than 360° that satisfies the equation $1 + \cos^2 x = \sin x$
- 140 1930_08_PT_06 Trigonometry: Reference Angles
Express $\sin 255^\circ$ as a function of a positive angle less than 90°
- 141 1930_08_PT_07 Trigonometric Identities
If $\cot A = \frac{12}{5}$ and A is an angle of a triangle, find $\cos A$.
- 142 1930_08_PT_08 Triangles: Isosceles
In an isosceles triangle the base is 4 and each of the equal sides is 8; find to the *nearest minute* one of the equal angles.
- 143 1930_08_PT_09 Circles: Radian Measure
Reduce $33^\circ 20'$ to radians. [Leave answer in terms of π]
- 144 1930_08_PT_10 Trigonometric Identities: Angle Sum or Difference
Write $\sin A + \sin B$ in an equivalent product form.
- 145 1930_08_PT_11 Trigonometric Identities
In a right triangle, $\sec A = 3$; find $\tan A$.
- 146 1930_08_PT_12 Trigonometric Functions: Inverses of
In the right triangle ABC , if $A = \cos^{-1} \frac{12}{13}$, find $\tan A$.
- 147 1930_08_PT_13 Trigonometric Ratios: Cofunction and Reciprocal
In a right triangle, $\cot A = \frac{4}{9}$ and $b = 16$; find a .
- 148 1930_08_PT_14 Trigonometric Equations
Given $\sqrt{\sin A} = \frac{1}{2}$; solve for the positive value of A less than 90° .
- 149 1930_08_PT_15 Trigonometric Functions: Evaluating
Given $\tan x = 1.3108$; find the value of x to the *nearest minute*.
- 150 1930_08_PT_16 Trigonometry: Finding Area
What is the area of triangle ABC in terms of b , c and angle A ?

- 151 1930_08_PT_17 Trigonometry: Finding Sides
From a balloon that is directly over a certain point the angle of depression of another point 10 miles distant in the same horizontal plane is $14^{\circ} 20'$; find the height of the balloon.
- 152 1930_08_PT_18 Trigonometric Functions: Logarithms of
Find $\log \sin 62^{\circ} 41' 24''$
- 153 1930_08_PT_19 Trigonometric Functions: Logarithms of
Give $\log \cos A = 9.91975 - 10$; find A correct to the nearest minute.
- 154 1930_08_PT_20 Trigonometry: Finding Area
Find the area of a triangle whose sides are 2, 3, and 4.
- 155 1930_08_PT_21 Trigonometry: Finding Sides Using Two Triangles
A lighthouse was observed N. 73° E of a ship. After the ship had steamed due east $4\frac{1}{2}$ miles, the lighthouse was observed to be N. $57^{\circ} 40'$ E. of the ship. If the ship continues its course in the same direction, how close will it come to the lighthouse? [12 $\frac{1}{2}$]
- 156 1930_08_PT_22 Trigonometry: Law of Cosines
Two objects, A and B , each visible and accessible from C , are separated by a building. AC is 307 feet, BC is 282 feet and angle ACB is $42^{\circ} 31'$. Find distance AB . [12 $\frac{1}{2}$]
- 157 1930_08_PT_23 Trigonometry: Law of Cosines
Find the angle subtended at the observer's eye by a rod 14.2 feet long, one end of which is 9.8 feet from the eye and the other 15.4 feet from the eye. [12 $\frac{1}{2}$]
- 158 1930_08_PT_24a Trigonometric Formulas: Derivations of
Derive the formula for $\sin(x - y)$ when x and y are acute. [5]
- 159 1930_08_PT_24b Trigonometric Identities: Double and Half Angle
If $\tan A = \frac{1}{4}$ and A is in the third quadrant, find the value of $\tan \frac{1}{2} A$. [4 $\frac{1}{2}$]
- 160 1930_08_PT_25a Proofs: Trigonometric
Prove the following identity: $\sin 2x = \frac{2 \tan x}{1 + \tan^2 x}$ [6]
- 161 1930_08_PT_25b Trigonometric Equations
Solve the following for positive values less than 360° :
 $\sin x = \cos 2x$ [6 $\frac{1}{2}$]
- 162 1930_08_PT_26 Trigonometric Graphs
On the same set of axes plot the graphs of $y = \sin x$ and $y = \sin \frac{1}{2} x$ for values of x at intervals of 30° from 0° to 360° inclusive [5, 5]. Indicate on the y -axis the position that will represent the positive value of y for which
 $\sin x = \sin \frac{x}{2}$. [2 $\frac{1}{2}$]

PT - Plane Trigonometry (1940)

- 163 1940_01_PT_01 Trigonometric Functions: Evaluating
The numerical value of $\tan \frac{\pi}{3}$ is
- 164 1940_01_PT_02 Trigonometric Functions: Evaluating
The numerical value of $\cos(-300^\circ)$ is
- 165 1940_01_PT_03 Functions: Inverses of
The solution of the equation $3 \tan A = 2$, expressed as an inverse function, is $A = \dots$
- 166 1940_01_PT_04 Logarithms
Expressed to the *nearest tenth*, the number whose logarithm is 2.5604 is
- 167 1940_01_PT_05 Trigonometric Functions: Evaluating
If $\sin A = .8930$ and A is less than 90° , the value of A correct to the *nearest minute* is
- 168 1940_01_PT_06 Trigonometric Functions: Logarithms of
The value of $\log \cos 29^\circ 33'$ is
- 169 1940_01_PT_07 Trigonometric Identities: Double and Half Angle
The formula for $\cos^2 \frac{1}{2} A$ in terms of $\cos A$ is
 $\cos^2 \frac{1}{2} A = \dots$
- 170 1940_01_PT_08 Trigonometric Identities
If A is an acute angle, $\csc A$, expressed as a function of $\cos A$, is $\csc A = \dots$
- 171 1940_01_PT_09 Trigonometric Functions: Evaluating
If x and y are acute angles, and $\sin x = \frac{3}{5}$ and
 $\cos y = \frac{12}{13}$, the numerical value of $\sin(x - y)$ is
- 172 1940_01_PT_10 Trigonometric Equations
The value of x greater than 0° and less than 360° which satisfies the equation $2 \sin^2 x - 3 \sin x = 0$ is
....
- 173 1940_01_PT_11 Triangles: Isosceles
In an isosceles triangle the vertex angle is 50° and the length of the base is 30 inches. The length of the altitude drawn upon the base, correct to the *nearest integer*, is ... inches.
- 174 1940_01_PT_12 Trigonometry: Law of Cosines
In $\triangle ABC$, $c = 20$, $b = 14$, $A = 45^\circ$. The area of $\triangle ABC$ is [Answer may be left in radical form.]
- 175 1940_01_PT_13 Trigonometry: Law of Cosines
In $\triangle ABC$, if $a = 2$, $b = 6$ and $c = 7$, then the numerical value of $\cos B$ is....
- 176 1940_01_PT_14 Trigonometry: Law of Sines
In $\triangle ABC$, if $A = 75^\circ$, $B = 15^\circ$ and $(a + b) = 12$, then $(a - b) = \dots$ [Answer may be left in radical form.]
- 177 1940_01_PT_15 Trigonometry: Law of Sines
In $\triangle ABC$, if $A = 30^\circ$, $B = 45^\circ$ and $a = 10$, then $b = \dots$ [Answer may be left in radical form.]
- 178 1940_01_PT_16 Trigonometric Functions: Evaluating
If $\tan x = \frac{1}{2}$, the value of $\tan 2x$ is
- 179 1940_01_PT_17 Trigonometric Identities: Angle Sum or Difference
 $\sin 40^\circ + \sin 20^\circ$ equals (a) $\sin 60^\circ$, (b) $\cos 20^\circ$ or (c) $\cos 10^\circ$.
- 180 1940_01_PT_18 Trigonometric Functions: Properties of
If $\tan A = x$, then $\cot(180^\circ - A)$ equals (a) $\frac{1}{x}$, (b) $-\frac{1}{x}$ or (c) $-x$.
- 181 1940_01_PT_19 Logarithms
If $\log b = x$, then $\log 100b$ equals (a) $100x$, (b) $2x$ or (c) $x + 2$.

- 182 1940_01_PT_20 Trigonometric Functions: Evaluating
The maximum value of $\sin 2x + \cos y$ is (a) 1, (b) 2 or (c) 3.

- 183 1940_01_PT_21a Proofs: Trigonometric

Prove the identity: $\tan y = \frac{\cos(x-y)}{\sin x \cos y} - \cot x$ [4]

- 184 1940_01_PT_21b Trigonometric Equations

Solve the following equation for all values of x greater than 0° and less than 360° :

$$\csc x - 2 \sin x = \cot x \quad [6]$$

- 185 1940_01_PT_22 Trigonometric Formulas: Derivations of
Starting with the formula for the cosine of the sum of two angles, derive the formula for the sine of half an angle. [10]

- 188 1940_01_PT_25 Proofs: Trigonometric

Prove: $r(\cos \theta + i \sin \theta) \times r'(\cos \phi + i \sin \phi) = rr' [\cos(\theta + \phi) + i \sin(\theta + \phi)]$ [10]

* This question is based on one of the optional topics in the syllabus.

- 189 1940_01_PT_26 Trigonometry: Law of Sines

In $\triangle ABC$, $AB = 81$ feet, $A = 61^\circ$, $C = 73^\circ$; find the length AC correct to the *nearest foot*. [10]

- 190 1940_01_PT_27 Trigonometry: Finding Sides Using Two Triangles

From a point on level ground the angle of elevation of the top of a hill is $14^\circ 10'$. From a second point 1000 feet nearer the foot of the hill the angle of elevation of its top is $17^\circ 50'$. Find the height of the hill correct to the *nearest foot*. [10]

- 191 1940_01_PT_28 Trigonometry: Law of Cosines

From a point 175 feet from one end of a wall and 264 feet from the other end the wall subtends an angle of 50° . Find, correct to the *nearest foot*, the length of the wall. [10]

- 186 1940_01_PT_23 Trigonometry: Finding Sides Using Two Triangles

Given right triangle ADC , B any point on AC and line BD drawn. Derive a formula for DC in terms of AB , angle x and angle y . [10]

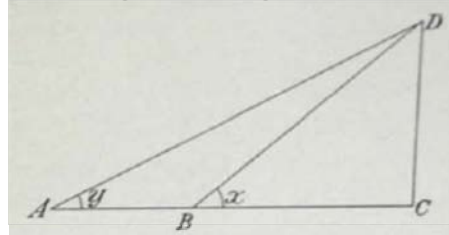

- 187 1940_01_PT_24 Trigonometric Graphs

a) Draw the graph of $y = \sin x$ as x varies from 0° to 180° inclusive in intervals of 30° . [2]

b) Using the same set of axes as in a, draw the graph of $y = \cos 2x$ as x varies from 0° to 180° inclusive in intervals of 15° . [6]

How many values of x from 0° to 180° inclusive are there for which $\sin x = \cos 2x$? [1]

- 192 1940_01_PT_29 Trigonometry: Finding Sides

A vertical tower stands at the top of a hill which is inclined 16° to the horizontal. At a point 95 feet down the hill from the base of the tower, the tower subtends an angle of 38° . Find, correct to the *nearest foot*, the height of the tower. [10]

- 193 1940_06_PT_01 Trigonometric Functions: Evaluating

The numerical value of $\sin \frac{\pi}{2}$ is

- 194 1940_06_PT_02 Trigonometric Functions: Evaluating

Find the numerical value of $\tan(-135^\circ)$.

- 195 1940_06_PT_03 Trigonometric Functions: Inverses of

Find correct to the *nearest minute*, the positive acute angle A when $A = \cos^{-1}.9381$.

- 196 1940_06_PT_04 Trigonometric Functions: Logarithms of
Find $\log \sin 34^\circ 16'$.
- 197 1940_06_PT_05 Logarithms
Find, correct to the *nearest hundredth*, the number whose logarithm is 1.7060.
- 198 1940_06_PT_06 Trigonometric Identities
Express the cotangent of a positive acute angle A in terms of the sine of A .
- 199 1940_06_PT_07 Trigonometric Functions: Evaluating
Write the value of the cosine of an acute angle whose tangent is $\frac{12}{5}$.
- 200 1940_06_PT_08 Trigonometric Functions: Evaluating
What is the minimum positive value of $3 \sec 2x$?
- 201 1940_06_PT_09 Trigonometric Identities: Double and Half Angle
If $\sin x = a$, express $\cos 2x$ in terms of a .
- 202 1940_06_PT_10 Trigonometric Identities: Double and Half Angle
If $\cos A = b$, express $\sin^2 \frac{1}{2} A$ in terms of B .
- 203 1940_06_PT_11 Logarithms
If $\log a = 4.2484$ and $\log b = 3.1242$, find $\log \frac{b^2}{a}$.
- 204 1940_06_PT_12 Trigonometry: Law of Sines
In $\triangle ABC$, express c in terms of a , $\sin A$ and $\sin C$.
- 205 1940_06_PT_13 Trigonometry: Law of Cosines
In $\triangle ABC$, $a = 6$, $b = 3$, $c = 8$; find $\cos A$. [Answer may be left in fractional form.]
- 206 1940_06_PT_14 Trigonometry: Law of Cosines
In $\triangle ABC$, $C = 60^\circ$ and $\frac{a+b}{a-b} = \frac{\sqrt{3}}{1}$, find $\tan \frac{1}{2} (A - B)$.
- 207 1940_06_PT_15 Trigonometric Equations
Find the value of x between 0° and 90° which satisfies the equation $\tan^2 x - \tan x = 0$.
- 208 1940_06_PT_16 Trigonometry: Law of Sines
In $\triangle ABC$, $C = 90^\circ$, $c = 10$, $A = 22^\circ 30'$; find b correct to the *nearest integer*.
- 209 1940_06_PT_17 Trigonometric Identities
The statement $\tan A \sin 2A = 2 \sin^2 A$ is true for (a) only one value of A , (b) no value of A or (c) all values of A .
- 210 1940_06_PT_18 Trigonometry: Law of Sines - The Ambiguous Case
Given $A = 30^\circ$, $c = 10$, $a = 12$; then (a) only one triangle can be constructed with the given parts, (b) two such triangles are possible or (c) no such triangle exists.
- 211 1940_06_PT_19 Trigonometric Functions: Properties of
As $\cos A$ increases from -1 to 0 , $\csc A$ (a) decreases from ∞ to 1 , (b) increases from $-\infty$ to -1 or (c) decreases from -1 to $-\infty$.
- 212 1940_06_PT_20 Trigonometric Functions: Properties of
As x varies from 0° to 270° , the graphs of the functions $y = \tan x$ and $y = \cos x$ intersect in (a) one point, (b) two points or (c) three points.
- 213 1940_06_PT_21a Proofs: Trigonometric
Prove the identity: $\cos 2A = \frac{1 - \tan^2 A}{1 + \tan^2 A}$ [5]
- 214 1940_06_PT_21b Trigonometric Equations
Find the positive angle less than 180° which satisfies the equation $3 \cos^2 x + 2 \sin x - 2 = 0$
- 215 1940_06_PT_22 Trigonometry: Finding Area
Derive the formula for the area of triangle ABC in terms of b , c and A . [Consider only the case where A is obtuse.] [10]

- 216 1940_06_PT_23a Trigonometry: Law of Cosines
Derive the relationship $\frac{a}{\sin A} = \frac{c}{\sin C}$ for the case where A and C of $\triangle ABC$ are acute. [4]
- 217 1940_06_PT_23b Trigonometric Formulas: Derivations of
Starting with the formulas for $\sin(x+y)$ and $\cos(x+y)$, derive the formula for $\tan(x+y)$. [6]
- 218 1940_06_PT_24 Trigonometric Functions: Properties of
a) Draw and label clearly the line values of the six trigonometric functions of an angle in the second quadrant. [4]
b) For *each* function indicate the line segment representing it and state whether the line segment is positive or negative. [6]
- 219 1940_06_PT_25 Trigonometry: Polar Form
Using De Moivre's Theorem, express $(2 + 2i\sqrt{3})^4$ in the form $a + bi$. [10]
* This question is based on one of the optional topics in the syllabus.
- 220 1940_06_PT_26 Trigonometry: Law of Sines
In $\triangle ABC$, $c = 28.7$, $a = 36.3$, $A = 50^\circ 25'$; find C correct to the *nearest minute*. [10]
- 221 1940_06_PT_27 Trigonometric Functions: Logarithms of
In $\triangle ABC$, $a = 10.26$, $b = 15.50$, $c = 18.24$; also $\tan \frac{A}{2} = \sqrt{\frac{(s-b)(s-c)}{s(s-a)}}$, where $s = \frac{1}{2}(a+b+c) = 22$
Fill in the following outline, finding A correct to the *nearest minute*: [10]

$\log(s-b) = \dots$	$\log s = \dots$
$\log(s-c) = \dots$	$\log(s-a) = \dots$
$\log(s-b)(s-c) = \dots$	$\log s(s-a) = \dots$

 $\log \tan \frac{A}{2} \dots$
 $\frac{A}{2} = \dots$
 $A = \dots$
- 222 1940_06_PT_28 Trigonometry: Finding Sides
Two observers 5280 feet apart on a straight horizontal road observe a balloon between them directly above the road. At the points of observation the angles of elevation of the balloon are 60° and 75° . Find, correct to the *nearest foot*, the height of the balloon. [10]
- 223 1940_06_PT_29 Trigonometry: Law of Cosines
 A and B are points on opposite sides of a lake at its greatest width. A point C is 2820 feet from B and 2240 feet from A ; the angle ACB is 64° . Find, correct to the *nearest foot*, the greatest width of the lake. [10]
- 224 1940_08_PT_01 Trigonometric Identities: Angle Sum or Difference
Complete the formula $\cos x \cos y - \sin x \sin y = \dots$
- 225 1940_08_PT_02 Logarithms
What is the number whose logarithm is .36983?
- 226 1940_08_PT_03 Trigonometric Functions: Logarithms of
If $\log \tan \frac{A}{2} = 9.1385 - 10$, what is the value of A ?
- 227 1940_08_PT_04 Trigonometric Identities
Express the secant of a positive acute angle X in terms of its tangent.
- 228 1940_08_PT_05 Trigonometric Functions: Logarithms of
Find $\log \cot 27^\circ 12'$.
- 229 1940_08_PT_06 Trigonometry: Reference Angles
What is the value of $\sin(-240^\circ)$?
- 230 1940_08_PT_07 Trigonometric Identities: Double and Half Angle
Express $\sin^2 \frac{1}{2} A$ in terms of $\cos A$.
- 231 1940_08_PT_08 Trigonometric Identities: Double and Half Angle
Express $\cos A$ in terms of $\cos 2A$, if A is a positive acute angle.

- 232 1940_08_PT_09 Trigonometry: Law of Cosines
In triangle ABC, $a = 9$, $b = 7$, and $c = 5$, find the value of $\cos A$.
- 233 1940_08_PT_10 Trigonometry: Finding Area
If $A = 56^\circ$, $b = 10$ feet and $c = 20$ feet, find correct to the nearest square foot the area of triangle ABC.
- 234 1940_08_PT_11 Trigonometry: Law of Sines
In triangle ABC, if $A = 30^\circ$, $B = 105^\circ$ and $a = 20$, what is the value of c . [Answer may be left in radical form.]
- 235 1940_08_PT_12 Trigonometric Equations
What value of x between 90° and 180° satisfies the equation $2 \sin^2 x + 3 \sin x = 2$?
- 236 1940_08_PT_13 Trigonometric Functions: Properties of
If x is a positive acute angle, what trigonometric function of x can increase from $\frac{1}{3}$ to 2 as x increases?
- 237 1940_08_PT_14 Circles: Arc Measure
Express in terms of π the number of degrees in a central angle which intercepts an arc twice as long as the radius of the circle.
- 238 1940_08_PT_15 Triangles: Vectors
If forces of 15 pounds and 8 pounds act on a body at right angles to each other, find, correct to the nearest degree, the angle which the resultant will make with the 15-pound force.
- 239 1940_08_PT_16 Trigonometric Functions: Inverses of
 $\cos^{-1} \frac{5}{16}$ is equal to (a) $33^\circ 33'$, (b) $33^\circ 34'$, (c) $33^\circ 35'$ or (d) $33^\circ 36'$.
- 240 1940_08_PT_17 Logarithms
 $\log \frac{a^2}{b}$ is equal to (a) $2 \log a - b$, (b) $\log 2a - \log b$, (c) $2a - b$ or (d) $2 \log a - \log b$.
- 241 1940_08_PT_18 Trigonometric Functions: Properties of
As A increases from 180° to 270° , $\sin A$ (a) increases from 0 to 1, (b) decreases from 1 to 0, (c) decreases from 0 to -1 or (d) increases from -1 to 0.
- 242 1940_08_PT_19 Trigonometric Equations
The number of values of x which satisfy the equation $2 \csc^2 x + \csc x = 0$ is (a) one, (b) two, (c) none or (d) an infinite number.
- 243 1940_08_PT_20 Systems: Other Nonlinear
As x increases from 0° to 360° inclusive, the number of points in which the graph of $\sin x$ intersects the graph of $\sin \frac{1}{2} x$ is (a) one, (b) two, (c) three or (d) four.

244 1940_08_PT_21 Using Substitution in Expressions and Equations

In triangle ABC , $A = 86^\circ 18'$, $b = 39.82$ and $c = 15.32$; find C by copying and completing the following outline:

$$\tan \frac{1}{2}(B - C) = \frac{(b - c) \tan \frac{1}{2}(B + C)}{b + c}$$

$$b - c = \text{-----} [1]$$

$$\frac{1}{2}(B + C) = \text{-----} [1]$$

$$b + c = \text{-----} [1]$$

$$\log(b - c) = \text{-----} [1]$$

$$\log \tan \frac{1}{2}(B + C) = \text{-----} [1]$$

$$\log \left[(b - c) \tan \frac{1}{2}(B + C) \right] = \text{-----} [1]$$

$$\log(b + c) = \text{-----} [1]$$

$$\log \tan \frac{1}{2}(B - C) = \text{-----} [1]$$

$$\frac{1}{2}(B - C) = \text{-----} [1]$$

$$C = \text{-----} [1]$$

245 1940_08_PT_22a Trigonometric Equations

Solve for positive values of x less than 360° :

$$2 + \cos 2x = 2 \sin^2 x \quad [6]$$

246 1940_08_PT_22b Trigonometric Identities

Express $(\sin x - \cos x)^2$ in terms of $\sin 2x$. [4]

247 1940_08_PT_23 Trigonometric Formulas: Derivations of

a Starting with the formula for the tangent of the sum of two angles, derive the formula for the tangent of the double angle. [4]

b Starting with the formulas for the sine of the sum and the sine of the difference of two angles, derive the formula:

$$\sin x + \sin y = 2 \sin \frac{1}{2}(x + y) \cos \frac{1}{2}(x - y) \quad [6]$$

248 1940_08_PT_24 Trigonometric Formulas: Derivations of

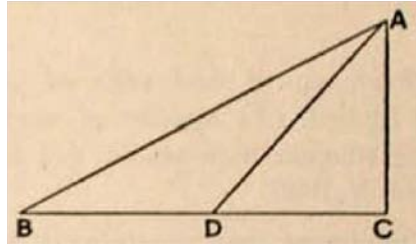

The height of an object, AC , in the figure above, may be found by using the formula:

$$AC = \frac{BD}{\cot DBA - \cot CDA}$$

Derive this formula. [10]

249 1940_08_PT_25 Trigonometry: Law of Sines

A straight line, AB , 200 feet long, is measured along one bank of a river. C is an object on the opposite bank. The angles BAC and CBA are observed to be $67^\circ 40'$ and $43^\circ 30'$ respectively. Find the width of the river at C . [10]

250 1940_08_PT_26 Trigonometry: Law of Cosines
In triangle ABC , $a = 5.43$, $b = 4.81$ and $c = 3.02$.
Using logarithms, find A correct to the *nearest minute*. [10]

251 1940_08_PT_27 Trigonometry: Finding Sides Using Two Triangles
From a certain point, the angle of elevation of a balloon 5000 feet high was observed to be $35^\circ 20'$. Ten minutes later, from the same point, the elevation was $47^\circ 50'$. If the balloon ascended uniformly and vertically, how fast did it move? [10]

252 1940_08_PT_28 Numbers: Complex
a Express $\frac{2+3i}{5+4i}$ in the form $a+bi$. [3]
b Express $6+6i$ in its trigonometric form. [4]
c Express $3(\cos 210^\circ + i \sin 210^\circ)$ in the form $a+bi$. [3]
This question is based on one of the optional topics in the syllabus.

S1 - The Sequential Course I Curriculum (1980-1990)

- 1 1980_01_S1_01 Rationals: Solving

Solve for x : $\frac{3}{5} = \frac{9}{x}$

- 2 1980_01_S1_02 Equations: Simple

Solve for x : $3(2x - 1) = 21$

- 3 1980_01_S1_03 Polynomials: Multiplication and Division of

Express as a trinomial: $(2x + 3)(x - 4)$

- 4 1980_01_S1_04 Equations: Simple with Decimals

Solve for x : $x - .04 = 1.6$

- 5 1980_01_S1_05 Quadratics: Difference of Perfect Squares

Factor: $4x^2 - 25$

- 6 1980_01_S1_06 Polynomials: Addition and Subtraction of

If the sides of a triangle are represented by $2x$, $x + 5$, and $3x - 6$, express the perimeter of the triangle in terms of x .

- 7 1980_01_S1_07 Similarity

In the accompanying diagram of triangles ABC and DGF , $\angle A \cong \angle D$ and $\angle B \cong \angle G$. If $\overline{AB} = 4$, $\overline{DF} = 9$, and $\overline{AC} = 3$, what is the length of \overline{DG} ?

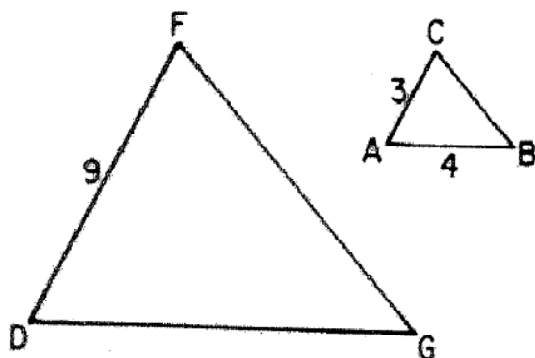

- 8 1980_01_S1_08 Sets: Replacement

If the replacement set for x is $\{-3, -1, 0, 1, 3\}$, write the members of the solution set for $3x < 0$.

- 9 1980_01_S1_09 Systems: Linear

Solve the following system of equations for x :

$$3x + y = 5$$

$$2x - y = 5$$

- 10 1980_01_S1_10 Equations: Literal

Solve for x in terms of a , b , and c :

$$ax + b = c$$

- 11 1980_01_S1_11 Complementary, Supplementary and Vertical Angles

If two angles of a triangle are complementary, find the number of degrees in the third angle.

- 12 1980_01_S1_12 Use Substitution with Expressions and Equations

If $x = -3$ and $y = 2$, find the value of $(xy)^2$.

- 13 1980_01_S1_13 Central Tendency: Averages

Express the mean (average) of $x + 1$ and $3x - 3$ as a binomial.

- 14 1980_01_S1_14 Probability: Theoretical

A card is drawn from a standard deck of 52 cards. What is the probability that it is a king or an ace?

- 15 1980_01_S1_15 Probability: Theoretical

An advertising display has 20 red lights, 15 blue lights, 15 green lights, and 10 yellow lights. What is the probability that the first light to burn out is red?

- 16 1980_01_S1_16 Probability: Mutually Exclusive Events

If the probability that Robin's team will win is $\frac{4}{5}$, what is the probability that they will *not* win?

- 17 1980_01_S1_17 Combinatorics: Permutations

How many arrangements of two letters can be formed from the letters O, L, Y, M, P, I, C, S if each letter is used only once in each arrangement?

18 1980_01_S1_18 Combinatorics: Combinations
 There are 6 roads between Plattsburgh and Lake Placid. In how many ways can a person travel from Plattsburgh to Lake Placid and back to Plattsburgh?

19 1980_01_S1_20 Triangles: Isosceles
 If one base angle of an isosceles triangle measures 35° , find the measure of the vertex angle of the triangle.

20 1980_01_S1_21 Complementary, Supplementary and Vertical Angles
 As shown in the accompanying figure, vertical angles have degree measures of x and $2x - 35$. Find x .

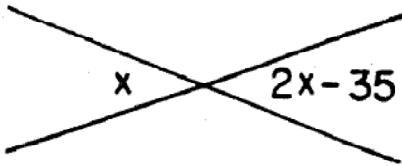

21 1980_01_S1_22 Circles: Center, Radius and Circumference
 If the area of a circle is 64π , what is the radius of the circle?

22 1980_01_S1_23 Polygons and Circles: Inscribed
 In the accompanying figure, equilateral triangle ABC is inscribed in circle O . Find the number of degrees in arc AB .

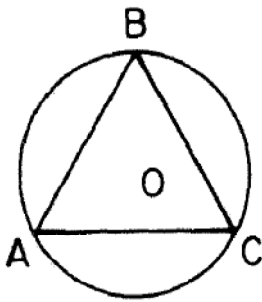

23 1980_01_S1_24 Triangles: Pythagoras
 The length and width of a rectangle are 15 and 8, respectively. Find the length of a diagonal.

24 1980_01_S1_25 Logical Reasoning: Symbolic Logic
 If p represents "Today is Monday" and q represents "Tomorrow is Wednesday," write in symbolic form using p and q : "If today is Monday, then tomorrow is not Wednesday."

25 1980_01_S1_26 Exponents
 When $-15x^6$ is divided by $-5x^3$, the quotient is
 (1) $3x^2$
 (2) $-3x^2$
 (3) $3x^3$
 (4) $-3x^3$

26 1980_01_S1_27 Central Tendency
 For which set of numbers will the mean, median, and mode all be equal?
 (1) 2,2,5
 (2) 2,5,5
 (3) 2,3,3,4
 (4) 2,2,5,5

27 1980_01_S1_28 Points on a Line: Identification of
 Which pair of numbers represents a point that does not lie on the graph of $2x + 3y = 6$?
 (1) (0,2)
 (2) (2,3)
 (3) (3,0)
 (4) (6,-2)

28 1980_01_S1_29 Inequalities: Linear

Which solution set is represented by the graph below?

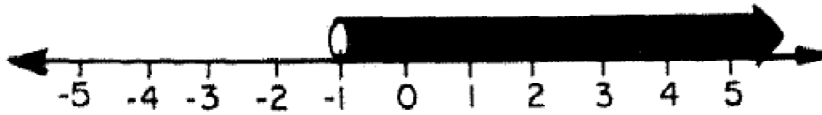

- (1) $\{x|x \geq -1\}$
- (2) $\{x|x \leq -1\}$
- (3) $\{x|x < -1\}$
- (4) $\{x|x > -1\}$

29 1980_01_S1_30 Radicals: Simplifying

The expression $\sqrt{90}$ is equivalent to

- (1) $9\sqrt{10}$
- (2) $6\sqrt{10}$
- (3) $3\sqrt{10}$
- (4) $10\sqrt{3}$

30 1980_01_S1_31 Proofs: Coordinate

Parallelogram $ABCD$ is shown in the accompanying figure. Which must be true?

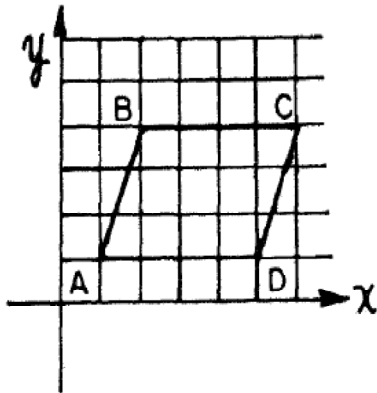

- a. The slope of \overline{AB} = slope of \overline{BC}
- b. The slope of \overline{AB} = slope of \overline{DC}
- c. The slope of \overline{AB} = slope of \overline{AD}
- d. The slope of \overline{DC} = slope of \overline{AD}

31 1980_01_S1_32 Slope Intercept Form of a Line

The graph of which equation has a slope of 3 and a y-intercept of -2?

- (1) $y = 3x - 2$
- (2) $y = 3x + 2$
- (3) $y = 2x - 3$
- (4) $y = 2x + 3$

32 1980_01_S1_33 Logical Reasoning: Symbolic Logic

Which is the inverse of $\sim p \rightarrow q$?

- (1) $q \rightarrow \sim p$
- (2) $p \rightarrow \sim q$
- (3) $\sim q \rightarrow p$
- (4) $p \rightarrow q$

33 1980_01_S1_34 Logical Reasoning: Contrapositive

Given the true statement: "If a figure is a square, then it is a rectangle."

Which sentence is also true?

- (1) If a figure is a rectangle, then it is a square.
- (2) If a figure is not a square, then it is not a rectangle.
- (3) If a figure is a square, then it is not a rectangle.
- (4) If a figure is not a rectangle, then it is not a square.

34 1980_01_S1_35 Logical Reasoning: Symbolic Logic
 Let p represent “ x is a prime number,” and let q represent “ x is an odd number.”
 Which is true if $x = 15$?

- (1) p
- (2) $\sim q$
- (3) $p \wedge q$
- (4) $p \vee q$

35 1980_01_S1_36a Inequalities: Graphing Systems of
 On the same set of coordinate axes, graph the following system of inequalities and label the solution set A:
 $2x - y \leq 3$ [8,2]
 $3x + y < 7$

36 1980_01_S1_36b Systems: Linear
 Solve graphically and check:
 $2x + y = 0$ [8,2]
 $y = 3x + 5$

37 1980_01_S1_37 Quadratics: Solving by Factoring
 The sides of a rectangle are x and $x + 6$. The area of the rectangle is 55. Find the lengths of the sides.
 [Only an algebraic solution will be accepted.]
 [5,5]

38 1980_01_S1_38 Logical Reasoning: Symbolic Logic

a. On your answer paper, copy and complete the truth table for the statement $\left[(p \rightarrow q) \wedge \sim q \right] \leftrightarrow \sim p$.

[9]

p	q	$p \rightarrow q$	$\sim q$	$(p \rightarrow q) \wedge \sim q$	$\sim p$	$\left[(p \rightarrow q) \wedge \sim q \right] \leftrightarrow \sim p$
T	T					
T	F					
F	T					
F	F					

b. Is $\left[(p \rightarrow q) \wedge \sim q \right] \leftrightarrow \sim p$ a tautology? [1]

39 1980_01_S1_39 Systems: Writing
 One number is 4 more than another number. If four times the smaller number is decreased by twice the larger number, the result is 12. Find *both* numbers.
 [5,5]

- 40 1980_01_S1_40 Polygons: Area of
As shown in the accompanying figure, $ABCD$ is a rectangle, E is a point on AB , $DE = 13$, $AE = 5$, and $DC = 20$.

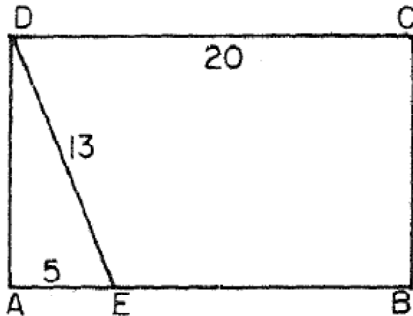

- Find AD . [2]
 - Find the perimeter of trapezoid $EBCD$. [2]
 - Find the area of $\triangle AED$. [2]
 - Find the area of rectangle $ABCD$. [2]
 - Find the area of trapezoid $EBCD$. [2]
- 41 1980_01_S1_41 Probability: Experimental
The following table represents the ages of the teachers at a school.

Interval	Number(f)
53-57	4
48-52	8
43-47	6
38-42	4
33-37	2
28-32	4
23-27	2

- In what interval is the median? [2]
- A teacher is chosen at random from this school. What is the probability that the teacher's age is in the interval 33-37? [2]
- What is the probability that the age of a teacher from this school is less than 38? [2]
- What is the probability that a teacher from this school is older than 57? [2]
- What percent of the teachers are in the interval 43-47? [2]

- 42 1980_01_S1_42 Systems: Linear
Solve algebraically for x and y and check:
 $3x + 2y = 1$ [8,2]
 $2x + 3y = 9$
- 43 1980_08_S1_01 Equations: Simple
Solve for x : $4x = 2(x + 8)$
- 44 1980_08_S1_02 Equations and Expressions: Using Substitution in
Find the value of $x^2 + 2y$ when $x = -3$ and $y = 1$.
- 45 1980_08_S1_03 Rate
It takes Bill x hours to paint his garage. Express in terms of x the part of the job Bill can finish in one hour.
- 46 1980_08_S1_04 Equations: Simple
Solve for x : $0.3x - 2 = 10$
- 47 1980_08_S1_05 Triangles: Interior and Exterior Angles of
Three angles of a triangle are in the ratio 1:3:5.
Find the number of degrees in the smallest angle.
- 48 1980_08_S1_06 Polynomials: Multiplication and Division of
Express $(x + 2)(x - 4)$ as a trinomial.
- 49 1980_08_S1_07 Percent
If the sales tax rate is 5%, find the amount of tax that must be paid on a \$35 watch.
- 50 1980_08_S1_08 Central Tendency
Joann's five test scores in math were 87, 87, 89, 90, and 100. What is the mode?
- 51 1980_08_S1_09 Polynomials: Factoring
Factor: $x^2 + 5x - 14$

52 1980_08_S1_10 Similarity

In the accompanying diagram, $\triangle ABC$ is similar to $\triangle RST$, $\angle A \cong \angle R$, $\angle B \cong \angle S$, and $\angle C \cong \angle T$. If $AB = 2$, $AC = 6$, and $RT = 15$, find the length of side RS .

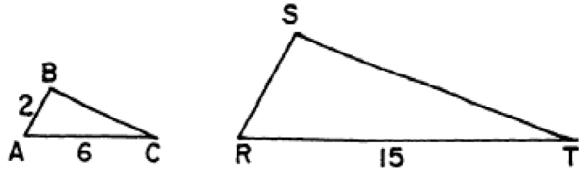

53 1980_08_S1_11 Probability: Theoretical

In a single toss of two coins, what is the probability of obtaining two heads?

54 1980_08_S1_12 Probability: Theoretical

A card is selected at random from a standard deck of 52 cards. What is the probability it is not an ace?

55 1980_08_S1_13 Perimeter

In the accompanying diagram of regular pentagon $ABCDE$, all sides are congruent. The perimeter is represented by $10x - 5$. What is a binomial expression for the length of one side of the pentagon?

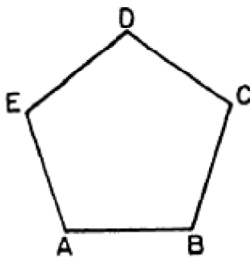

56 1980_08_S1_14 Complementary, Supplementary and Vertical Angles

In the accompanying figure, $\triangle ABC$ is a right angle, $m\angle ABD = 3x - 6$, and $m\angle DBC = x$. Find the value of x .

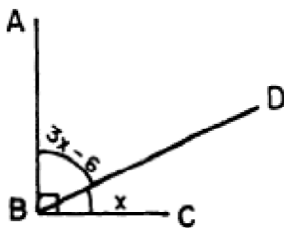

57 1980_08_S1_15 Equations and Expressions: Modeling

If 18 is subtracted from twice a certain number, the result is 36. Find the number.

58 1980_08_S1_16 Logical Reasoning: Symbolic Logic

Let p represent, "You open an account."

Let q represent, "You receive a gift."

Write in symbolic form using p and q : "If you open an account, then you receive a gift."

59 1980_08_S1_17 Equations: Literal

Solve for x in terms of a , b , and c : $ax + b = c$

60 1980_08_S1_18 Triangles: Pythagoras

The lengths of the two legs of a right triangle are 2 and 3. Find in radical form the length of the hypotenuse of the triangle.

61 1980_08_S1_19 Parallel Lines: Angles Involving

As shown in the diagram, parallel lines \overleftrightarrow{AB} and \overleftrightarrow{CD} are cut by transversal \overleftrightarrow{AEF} at points A and E , respectively, $m\angle EAB = 2x$, and the degree measure of $\angle DEF$ is 60. Find the value of x .

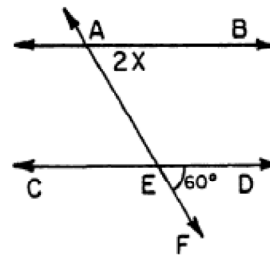

62 1980_08_S1_20 Systems: Linear

Solve the following system of equations for x :

$$3x + y = 9$$

$$x - y = 7$$

63 1980_08_S1_21 Inequalities: Linear
Which graph shows the solution of $-2 < x < 5$?

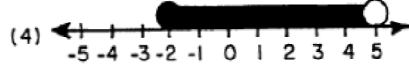
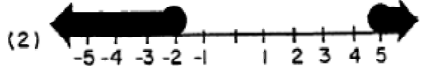
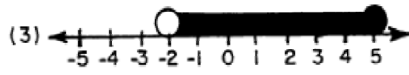
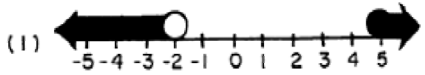

64 1980_08_S1_22 Polynomials: Multiplication and Division of
When $3x^3 + 3x$ is divided by $3x$, the quotient is

- (1) x^2
- (2) $x^2 + 1$
- (3) $x^2 + 3x$
- (4) $3x^3$

68 1980_08_S1_26 Numbers: Properties of Real
Which is an irrational number?

- (1) 0
- (2) $\frac{1}{3}$
- (3) $\sqrt{5}$
- (4) $\sqrt{9}$

65 1980_08_S1_23 Quadratics: Solving by Factoring
What is the solution set for the equation $x^2 + 2x - 15 = 0$?

- (1) {3,-5}
- (2) {3,5}
- (3) {-3,-5}
- (4) {-3,5}

69 1980_08_S1_27 Logical Reasoning: Symbolic Logic
If $p \wedge q$ is true, which must be true?

- (1) $\sim p$
- (2) $\sim q$
- (3) $p \rightarrow \sim q$
- (4) $p \vee q$

66 1980_08_S1_24 Circles: Area of
The area of a circle with radius 7 is

- (1) 49
- (2) 49π
- (3) 14π
- (4) 7π

70 1980_08_S1_28 Equations and Expressions: Modeling
The length of a rectangle is 5 centimeters longer than its width, w . The length of the rectangle can be represented by

- (1) $w + 5$
- (2) $w - 5$
- (3) $5 - w$
- (4) $5w$

67 1980_08_S1_25 Exponents: Operations with
The product $(-2xy^2)(3x^2y^3)$ is

- (1) $-5x^3y^5$
- (2) $-6x^2y^6$
- (3) $-6x^3y^5$
- (4) $-6x^3y^6$

71 1980_08_S1_29 Polygons and Circles: Inscribed
In the accompanying figure, triangle ABC is inscribed in a circle and arc AC measures 150° .

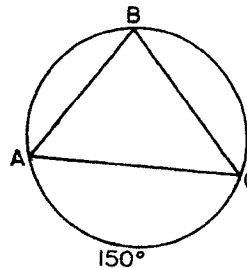

What is the number of degrees in $\angle ABC$?

- 72 1980_08_S1_30 Slope Intercept Form of a Line
The equation of a line whose slope is 2 and whose y-intercept is -2 is
- (1) $2y = x - 2$
 - (2) $y = -2$
 - (3) $y = -2x + 2$
 - (4) $y = 2x - 2$

- 73 1980_08_S1_31 Probability: Theoretical
A bag contains 5 black marbles and 10 red marbles. If one marble is drawn at random, what is the probability that it is black?
- (1) $\frac{5}{10}$
 - (2) $\frac{1}{15}$
 - (3) $\frac{5}{15}$
 - (4) $\frac{10}{15}$

- 76 1980_08_S1_34 Logical Reasoning: Symbolic Logic
What should be the last column of the truth table below?

p	q	$\sim p$	$\sim p \wedge q$
T	T	F	
T	F	F	
F	T	T	
F	F	T	

- | | | | |
|-----|-----|-----|-----|
| (1) | (2) | (3) | (4) |
| T | T | F | F |
| F | F | F | F |
| F | T | T | F |
| F | T | F | F |

- 77 1980_08_S1_35 Combinatorics: Permutations
The symbol for "factorial 4" is 4!. What is the value of 4!?
- (1) 24
 - (2) 16
 - (3) 8
 - (4) 4

- 74 1980_08_S1_32 Logical Reasoning: Contrapositive
Given the true statement: "If I own a *Buick*, then I own a car." Which statement must be true?
- (1) If I do not own a Buick, then I do not own a car.
 - (2) If I own a car, then I own a Buick.
 - (3) If I own a car, then I do not own a Buick.
 - (4) If I do not own a car, then I do not own a Buick.

- 75 1980_08_S1_33 Radicals: Operations with
The sum of $\sqrt{20}$ and $\sqrt{45}$ is
- (1) $5\sqrt{5}$
 - (2) $6\sqrt{5}$
 - (3) $13\sqrt{5}$
 - (4) $\sqrt{65}$

- 78 1980_08_S1_36 Systems: Linear
Solve graphically and check:
 $2x + 7 = 7$ [8,2]
 $x - y = 2$

- 79 1980_08_S1_37 Equations and Expressions: Modeling
The length of a rectangle is 5 more than 3 times its width. The perimeter of the rectangle is 34. Find the length and width of the rectangle. [*Only an algebraic solution will be accepted.*] [5,5]

80 1980_08_S1_38 Systems: Writing
 A high school athletic department sold 450 tickets to a varsity football game. Some of the tickets were sold in advance for \$1.00 each; the remainder were sold at the gate for \$1.50 each. If the total receipts from both sales was \$565.00, find the number of tickets that were sold at the gate. [Only an algebraic solution will be accepted.] [5,5]

81 1980_08_S1_39 Central Tendency
 The accompanying table shows the distribution of scores on a quiz.

Score	Frequency
100	5
90	4
80	3
70	7
60	0
50	1

- Find the total frequency. [2]
- Find the mode. [2]
- Find the median. [2]
- Find the mean. [4]

84 1980_08_S1_42 Logical Reasoning: Symbolic Logic

- On your answer paper, copy and complete the truth table for the tautology $(p \rightarrow \sim q) \leftrightarrow (\sim p \vee \sim q)$.

[8]

p	q	$\sim p$	$\sim q$	$p \rightarrow \sim q$	$\sim p \vee \sim q$	$(p \rightarrow \sim q) \leftrightarrow (\sim p \vee \sim q)$

- Let p represent, "I save money," and let q represent, "I spend money." Which sentence is equivalent to $(p \rightarrow \sim q)$?
 - I save money and I spend money.
 - I save money or I spend money.
 - I do not save money and I do not spend money.
 - I do not save money or I do not spend money. [2]

85 1990_06_S1_01 Similarity: Right Triangles

A 50-foot tree casts a shadow of 40 feet. At the same time, a boy casts a shadow of 4 feet. Expressed in feet, how tall is the boy?

82 1980_08_S1_40 Probability: Dependent Events

A sack contains 1 red, 1 white, and 2 blue disks. One disk is drawn at random and is not replaced. Then a second disk is drawn at random.

- Draw a tree diagram or list the pairs of the sample space showing all possible outcomes. [4]
- Determine the probability that:
 - Both disks are blue [2]
 - the first disk is red and the second disk is white [2]
 - both disks are white [2]

83 1980_08_S1_41 Equations and Expressions: Modeling

Find two consecutive positive integers such that the square of the smaller added to twice the larger is 50. [Only an algebraic solution will be accepted.] [4,6]

86 1990_06_S1_02 Triangles: Isosceles

In the accompanying diagram of $\triangle ABC$, $AC = BC$ and $m\angle A = 70$. Find the measure of the vertex angle.

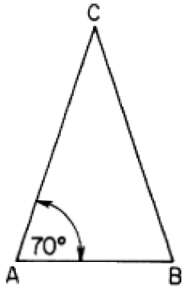

87 1990_06_S1_03 Complementary, Supplementary and Vertical Angles

In the accompanying diagram, AB and CD intersect at E . If $m\angle AED = 9x + 10$ and $m\angle BEC = 2x + 52$, find the value of x .

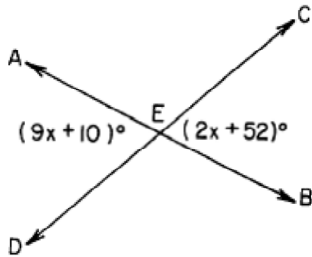

88 1990_06_S1_04 Logical Reasoning: Symbolic Logic

Let p represent the statement "I will win," and let q represent the statement "I practice." Write in symbolic form: "If I do not practice, then I will not win."

89 1990_06_S1_05 Rationals: Solving

Solve for x : $\frac{3x}{4} - 1 = 2$

90 1990_06_S1_06 Graphic Representation: Histograms and Tables

The histogram below shows the grade distribution for a mathematics test given to Ms. Keith's class. How many students are in the class?

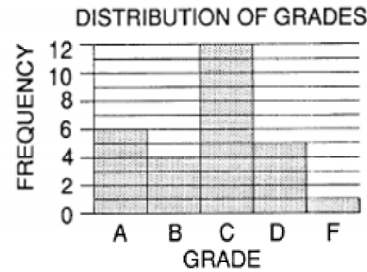

91 1990_06_S1_07 Equations: Simple with Decimals

Solve for x : $0.03x - 2.1 = 0.3$

92 1990_06_S1_08 Proportions

Solve for x : $\frac{3}{x+2} = \frac{1}{x}$, $x \neq 0$, $x \neq -2$

93 1990_06_S1_09 Polynomials: Addition and Subtraction of

The lengths of the sides of a trapezoid are represented by $2x + 3$, $4x - 5$, $3x + 2$, and $5x - 9$. Express the perimeter of the trapezoid as a binomial in terms of x .

94 1990_06_S1_10 Probability: Theoretical

If the replacement set for x is $\{2,3,4,5,6\}$, what is the probability that a number chosen at random from the replacement set will make the sentence $3x + 2 \leq 20$ true?

95 1990_06_S1_11 Equations: Simple

Solve for x : $4(2x - 1) = 2x + 35$

96 1990_06_S1_12 Polynomials: Multiplication and Division of

In rectangle $ABCD$, AB is represented by $2x + 1$ and BC is represented by $x + 3$. Express the area of rectangle $ABCD$ as a trinomial in terms of x .

97 1990_06_S1_13 Complementary, Supplementary and Vertical Angles

The measures of two supplementary angles are in the ratio 4:5. Find the number of degrees in the measure of the *smaller* angle.

98 1990_06_S1_14 Polynomials: Addition and Subtraction of
From $7x^2 - 4x$ subtract $5x^2 + 2x$.

99 1990_06_S1_15 Variation: Direct
If x varies directly as y , find x when $y = 1$ if $x = 12$ when $y = 4$.

100 1990_06_S1_16
Express $\frac{3}{2x} + \frac{5}{3x}$, $x \neq 0$, as a single fraction.

101 1990_06_S1_17 Triangles: Interior and Exterior Angles of
In the accompanying diagram, $\angle ACD$ is an exterior angle of $\triangle ABC$. If $m\angle B = 40$, $m\angle A = 2x$, and $m\angle ACD = 3x$, what is the value of x ?

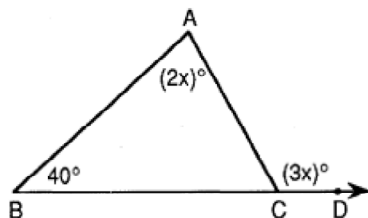

102 1990_06_S1_18 Volume
The volume of a rectangular solid is 180 cubic centimeters. The length is 10 centimeters and the width is 4 centimeters. Using the formula $V = lwh$, find the number of centimeters in the height.

103 1990_06_S1_19 Polynomials: Multiplication and Division of
The expression $(x - 4)^2$ is equivalent to
(1) $x^2 - 16$
(2) $x^2 + 16$
(3) $x^2 - 8x + 16$
(4) $x^2 + 8x + 16$

104 1990_06_S1_20 Exponents: Operations with
What is the product of $3x^2y^2$ and $2xy^3$?
(1) $6x^5y^5$
(2) $6x^4y^5$
(3) $6x^4y^6$
(4) $6x^5y^6$

105 1990_06_S1_21 Special Quadrilaterals: Parallelograms
Which property is *not* true for *all* parallelograms?
(1) Opposite angles are congruent.
(2) Consecutive angles are supplementary.
(3) Opposite sides are congruent.
(4) Diagonals are congruent.

106 1990_06_S1_22 Transformations: Reflections
In which figure is $\triangle A'B'C'$ a reflection of $\triangle ABC$ in line l ?

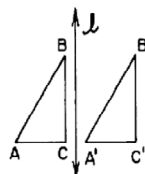

(1)

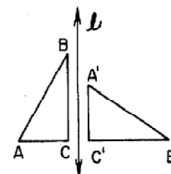

(3)

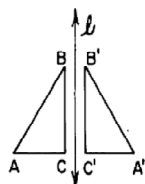

(2)

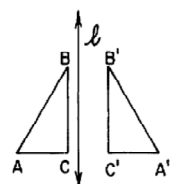

(4)

107 1990_06_S1_23 Triangles: Pythagoras
If the length of a rectangle is 3 and the width is 2, the length of the diagonal is
(1) $\sqrt{5}$
(2) $\sqrt{13}$
(3) 5
(4) 13

108 1990_06_S1_24 Equations: Graphing
Which phrase describes the graph of $y = -1$ on the coordinate plane?
(1) a line parallel to the y -axis and 1 unit to the right of it
(2) a line parallel to the y -axis and 1 unit to the left of it
(3) a line parallel to the x -axis and 1 unit below it
(4) a line parallel to the x -axis and 1 unit above it

109 1990_06_S1_25 Combinatorics: Permutations

What is the value of $\frac{6!}{3!}$?

- (1) 6
- (2) 2
- (3) 120
- (4) 720

110 1990_06_S1_26 Central Tendency: Averages

The set of scores on a mathematics test is 72, 80, 80, 82, 87, 89, and 91. The mean score is

- (1) 84
- (2) 83
- (3) 82
- (4) 80

111 1990_06_S1_27 Sets: Replacement

If x is an integer, which is the solution set of $-1 \leq x < 2$?

- (1) $\{0, 1\}$
- (2) $\{-1, 0, 1, 2\}$
- (3) $\{0, 1, 2\}$
- (4) $\{-1, 0, 1\}$

112 1990_06_S1_28 Equations: Literal

Which equation is equivalent to $x + 2y = 6$?

- (1) $y = -x + 6$
- (2) $y = -\frac{1}{2}x + 6$
- (3) $y = -x + 3$
- (4) $y = -\frac{1}{2}x + 3$

113 1990_06_S1_30 Quadratics: Solving by Factoring

What is the solution set of $x^2 - x - 20 = 0$?

- (1) $\{5, -4\}$
- (2) $\{-5, 4\}$
- (3) $\{-10, 2\}$
- (4) $\{10, -2\}$

114 1990_06_S1_31 Scientific Notation

Which number is equal to 3.6×10^5 ?

- (1) 360,000
- (2) 3,600,000
- (3) 0.000036
- (4) 0.0000036

115 1990_06_S1_32 Rationals: Undefined

Which value of x will make the fraction $\frac{x-3}{x+6}$ undefined?

- (1) 6
- (2) -6
- (3) 3
- (4) -3

116 1990_06_S1_33 Area and the Coordinate Plane

If the coordinates of the vertices of $\triangle ABC$ are $A(3,-2)$, $B(7,-2)$, and $C(5,5)$, what is the area of the triangle?

- (1) 10
- (2) 14
- (3) 20
- (4) 28

117 1990_06_S1_34 Radicals: Simplifying

The expression $2\sqrt{3} - \sqrt{27}$ is equivalent to

- (1) $2\sqrt{24}$
- (2) $5\sqrt{3}$
- (3) $-5\sqrt{3}$
- (4) $-\sqrt{3}$

118 1990_06_S1_35 Symmetry

Which figure does *not* have line symmetry?

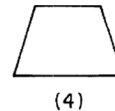
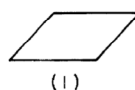

119 1990_06_S1_36 Inequalities: Graphing Systems of

a. On the same set of coordinate axes, graph the following system of inequalities:

$$y \leq -3x + 2 \quad [8]$$

$$y - x > 0$$

b. Write the coordinates of a point *not* in the solution set of the inequalities graphed in part a. [2]

- 120 1990_06_S1_37 Quadratics: Writing
 Twice the square of an integer is five less than eleven times the integer. Find the integer. *[Only an algebraic solution will be accepted.]* [4.6]

- 121 1990_06_S1_38 Systems: Linear
 Solve the following system of equations algebraically and check:
 $2x + 3y = 11$ [8,2]
 $5x - 2y = -20$

- 122 1990_06_S1_39 Polygons and Circles: Inscribed
 In rectangle $ABCD$, the ratio of $AB:BC$ is 4:3. The perimeter of the rectangle is 56 centimeters.

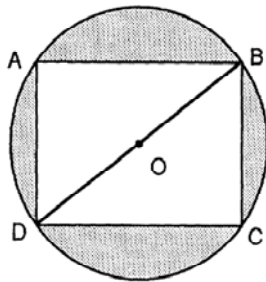

- Find AB . [2]
- Find BD . [3]
- Express, in terms of π , the area of circle O . [2]
- Express, in terms of π , the area of the shaded region. [3]

- 123 1990_06_S1_40 Graphic Representation: Histograms and Tables
 The table below shows the cumulative frequency of the ages of 35 people standing in a cafeteria line.

Interval	Cumulative Frequency
10-19	2
10-29	17
10-39	27
10-49	32
10-59	32
10-69	35

- a. *On your answer paper*, copy and complete the frequency table below, based on the data given in the cumulative frequency table above. [1]

Interval	Frequency
10-19	2
20-29	
30-39	
40-49	
50-59	
60-69	

- Construct a frequency histogram using the table completed in part a. [4]
- Using the frequency table in part G, in which interval does the median occur? [2]
- What is the probability that a person chosen at random from the line is at least 40 years old? [2]
- What is the probability that a person chosen at random from the line is between 50 and 59 years old? [1]

124 1990_06_S1_41 Probability: Dependent Events
Adam has a bag containing four yellow gumdrops and one red gumdrop. He will eat one of the gumdrops, and a few minutes later, he will eat a second gumdrop.

- What is the probability Adam will eat a yellow gumdrop first and a red gumdrop second? [3]
- What is the probability Adam will eat two yellow gumdrops? [3]
- What is the probability Adam will eat two gumdrops having different colors? [2.]
- What is the probability Adam will eat two red gumdrops? [2]

125 1990_06_S1_42 Logical Reasoning: Symbolic Logic
Let p represent: "The flowers are not in bloom."
Let q represent: "It is raining."

Let r represent: "The grass is green."

- Write, in symbolic form, the converse of "If the flowers are in bloom, then the grass is green." [2]
- Write, in symbolic form, the inverse of "If it is raining, the grass is green." [2]
- Write in sentence form: $p \wedge \sim q$ [2]
- Write in sentence form: $\sim r \vee \sim q$ [2]
- Which of these four statements must have the same truth value as $\sim q \rightarrow r$? [2]
 - $q \rightarrow \sim r$
 - $\sim r \rightarrow q$
 - $\sim q \rightarrow \sim r$
 - $r \rightarrow q$

126 1990_08_S1_01 Probability: Mutually Exclusive Events
The probability that an event will occur is $\frac{5}{8}$. What is the probability that the event will *not* occur?

127 1990_08_S1_02 Probability: Theoretical
A number is selected at random from the set $\{1,3,5,8,11,15\}$. What is the probability the number is greater than 8 or less than 3?

128 1990_08_S1_03 Equations: Simple
Solve for x : $7(x - 2) = 5(x + 4)$

129 1990_08_S1_04 Complementary, Supplementary and Vertical Angles

In the accompanying diagram, \overleftrightarrow{AB} and \overleftrightarrow{CD} intersect at point E . If $m\angle AEC = 5x$ and $m\angle BED = x + 28$, find the value of x .

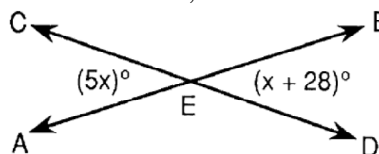

130 1990_08_S1_05 Central Tendency: Average Known with Missing Data

The data 6, 12, x , 7 have a mean of 10. Find the value of x .

131 1990_08_S1_06 Proportion

A machine can manufacture 1800 pencils in 30 minutes. At this same rate, how many minutes will it take to manufacture 3000 pencils?

132 1990_08_S1_07 Equations and Expressions: Modeling

The length of a side of a square is represented by $(3x - 1)$. If the perimeter of the square is 68, find the value of x .

133 1990_08_S1_08 Logical Reasoning: Symbolic Logic

Let p represent "Mary Hardy pitches," and let q represent "The Warriors will win the softball game." Write in symbolic form, using p and q , "The Warriors will win the softball game if and only if Mary Hardy pitches."

134 1990_08_S1_09 Equations: Simple with Decimals

Solve for x : $0.06x + 0.3x = 7.2$

- 135 1990_08_S1_10 Parallel Lines: Angles Involving

In the accompanying diagram, parallel lines \overleftrightarrow{AB} and \overleftrightarrow{CD} are intersected by \overleftrightarrow{EF} at G and H , respectively. If $m\angle AGH = 5x$ and $m\angle CHG = x + 12$, find the value of x .

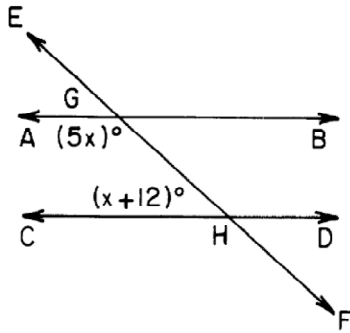

- 136 1990_08_S1_11 Polynomials: Addition and Subtraction of
Express the sum of $-2x^2 + 7x - 6$ and $3x^2 - 8x - 1$ as a trinomial.

- 137 1990_08_S1_12 Equations: Literal
Solve for r in terms of P , t , and I :
 $I = Prt$

- 138 1990_08_S1_13 Exponential Functions and Equations
Find the positive solution for the equation
 $4x^2 = 64$

- 139 1990_08_S1_14 Triangles: Interior and Exterior Angles of
The ratio of the measures of the angles of a triangle is 1:2:2. Find the measure of the *smallest* angle.

- 140 1990_08_S1_15 Similarity
In the accompanying diagram, $\triangle ABC$ is similar to $\triangle DEF$, $\angle A \cong \angle D$, and $\angle B \cong \angle E$. If $AB = 3$, $BC = 12$, $DE = x + 2$, and $EF = 18$, find the value of x .

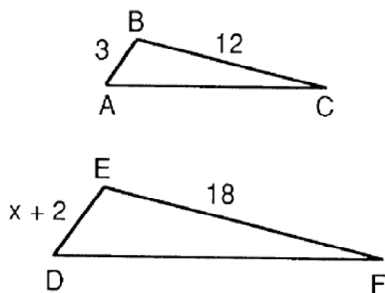

- 141 1990_08_S1_16 Radicals: N-Roots
If the volume of a cube is 64 cubic centimeters, how many centimeters are in the length of an edge of the cube?

- 142 1990_08_S1_17 Rationals: Solving
Solve for x : $\frac{x}{3} + \frac{x}{2} = 5$

- 143 1990_08_S1_18 Polynomials: Factoring
Express $2x^2 - 3x - 5$ as the product of two binomial factors.

- 144 1990_08_S1_19 Symmetry
Which kind of symmetry do all of these figures have?

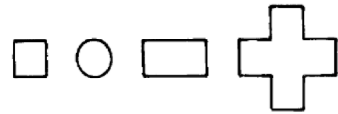

- (1) vertical line, only
- (2) horizontal line, only
- (3) both vertical line and horizontal line
- (4) neither vertical line nor horizontal line

- 145 1990_08_S1_20 Circles: Center, Radius and Circumference
The length of a diameter of a circle is $\frac{2}{a}$. What is the length of a radius of the circle?

- (1) $\frac{1}{a}$
- (2) 2
- (3) a
- (4) $\frac{1}{2a}$

- 146 1990_08_S1_21 Polynomials: Multiplication and Division of
The width of a rectangle is represented by $2x$ and the length is represented by $x^2 - x + 3$. Which expression represents the area of the rectangle?

- (1) $2x^3 - x + 3$
- (2) $x^2 + x + 3$
- (3) $2x^2 + 2x + 6$
- (4) $2x^3 - 2x^2 + 6x$

- 147 1990_08_S1_22 Conversions
What is the number of inches in x feet?

- (1) $12x$
(2) $\frac{x}{12}$
(3) $3x$
(4) $\frac{x}{3}$

- 148 1990_08_S1_23 Graphic Representation: Histograms and Tables
The table below represents the distribution of the ages of neighborhood children. Which interval contains the median?

Ages	Frequency
16-18	5
13-15	8
10-12	4
7-9	6
4-6	2
1-3	5

- (1) 4-6
(2) 7-9
(3) 10-12
(4) 13-15
- 149 1990_08_S1_24 Points on a Line: Identification of
If $(a, 3)$ is a point on the graph of the equation $2x + 3y = 5$, then the value of a is

- (1) 1
(2) 2
(3) -2
(4) 7

- 150 1990_08_S1_25
What is the sum of $3\sqrt{5}$ and $\sqrt{20}$?
- (1) 15
(2) $5\sqrt{5}$
(3) $5\sqrt{10}$
(4) $6\sqrt{5}$

- 151 1990_08_S1_26 Polynomials: Factoring
The binomials $(x - 2)$ and $(2x + 3)$ are the factors of which polynomial?

- (1) $2x^2 - 6$
(2) $2x^2 - x - 6$
(3) $2x^2 + x - 6$
(4) $2x^2 + 7x - 6$

- 152 1990_08_S1_27 Slope
What is the slope of the line whose equation is $y + 2x = 4$?

- (1) $\frac{1}{2}$
(2) 2
(3) -2
(4) 4

- 153 1990_08_S1_28 Similarity
In the diagram below, $\triangle ABC$ is similar but not congruent to $\triangle A'B'C'$. Which transformation is represented by $\triangle A'B'C'$?

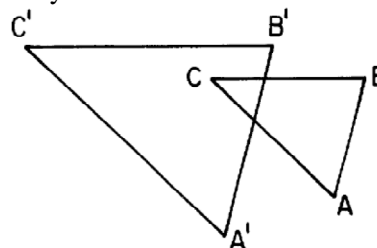

- (1) rotation
(2) translation
(3) reflection
(4) dilation

- 154 1990_08_S1_29 Logical Reasoning: Symbolic Logic
If $p \wedge \sim q$ is true, which statement must be true?

- (1) $\sim p$
(2) q
(3) $p \vee q$
(4) $p \rightarrow q$

- 155 1990_08_S1_30 Inequalities: Linear
Which graph represents the inequality $x < 2$?

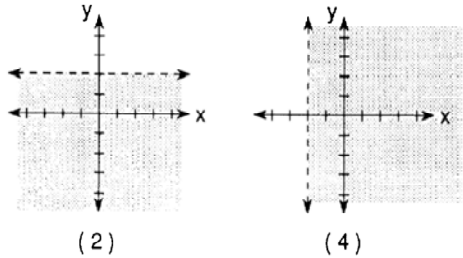
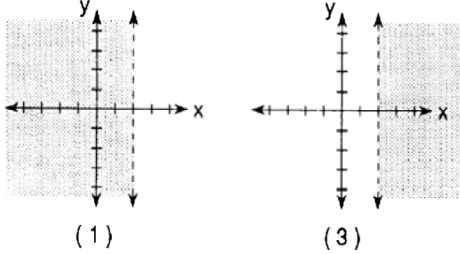

- 156 1990_08_S1_31 Exponents: Operations with
Which expression is equivalent to $(-2x^4)^2$?

- (1) $4x^6$
(2) $4x^8$
(3) $-4x^8$
(4) $4x^{16}$

- 157 1990_08_S1_32 Rationals: Addition and Subtraction of

What is the sum of $\frac{3}{2x}$ and $\frac{3}{6x}$, $x \neq 0$?

- (1) $\frac{7}{8x}$
(2) $\frac{13}{6x}$
(3) $\frac{7}{6x}$
(4) $\frac{13}{8x}$

- 158 1990_08_S1_33 Logical Reasoning: Symbolic Logic
The inverse of a given statement is $\sim s \rightarrow r$. What is the given statement?

- (1) $r \rightarrow s$
(2) $r \rightarrow \sim s$
(3) $\sim r \rightarrow s$
(4) $s \rightarrow \sim r$

- 159 1990_08_S1_34 Variation: Direct
Which table is an example of y varying directly with x ?

(1)

x	y
3	5
4	6
5	7

(3)

x	y
3	9
4	16
5	25

(2)

x	y
3	5
4	4
5	3

(4)

x	y
3	6
4	8
5	10

- 160 1990_08_S1_35 Scientific Notation
Which expression represents the number 0.00017 written in scientific notation?

- (1) 1.7×10^{-4}
(2) 1.7×10^4
(3) 1.7×10^{-3}
(4) 1.7×10^3

161 1990_08_S1_36 Logical Reasoning: Symbolic Logic

- a. Each part below consists of three sentences. *On your answer paper*, write the numbers 1 through 3, and next to each number, write the truth value (TRUE or FALSE) for the third sentence in each part, based on the truth values given for the first two sentences. If the truth value cannot be determined from the information given, write "CANNOT BE DETERMINED."

(1)	It rains or it is cold. It is cold. It rains.	TRUE FALSE ?	[2]
(2)	The month is June and it is not warm. The month is June. It is warm.	FALSE TRUE ?	[2]
(3)	If I study, I pass math. I pass math. I study.	TRUE TRUE ?	[2]

- b. *On your answer paper*, copy and complete the truth table for the statement $(p \rightarrow q) \leftrightarrow (\sim p \vee q)$.

p	q	$p \rightarrow q$	$\sim p$	$\sim p \vee q$	$(p \rightarrow q) \leftrightarrow (\sim p \vee q)$
T	T	T	F		
T	F	F	F		
F	T	T	T		
F	F	T	T		

162 1990_08_S1_37 Area and the Coordinate Plane

- a. On the same set of coordinate axes, graph the following system of equations:

$$y = x + 4 \quad [6]$$

$$x + y = 6$$

$$y = 2$$

- b. Find the area of the triangle whose vertices are the points of intersection of the lines graphed in part a. [4]

163 1990_08_S1_38 Systems: Quadratic Linear

The length of a rectangle is $\sqrt{65}$ centimeters. The diagonal of the rectangle is 5 centimeters more than the width. Find, in centimeters, the width of the rectangle. [5,5]

164 1990_08_S1_39 Probability: Theoretical

Lunch at the school cafeteria consists of a sandwich, a dessert, and a beverage. The sandwich choices are tuna, ham, or peanut butter. Dessert is a cookie or Jell-O, and the beverage is either milk or orange juice.

- Draw a tree diagram or list the sample space for all possible lunches. [4]
- Find the probability of a student having a tuna sandwich, Jell-O, and milk. [2]
- Find the probability of a student having milk as the beverage. [2]
- Find the probability of a student having a ham sandwich, a cookie or Jell-O, and orange juice. [2]

- 165 1990_08_S1_40 Graphic Representation: Histograms and Tables
The frequency histogram below shows the weights of the members of a Junior Varsity football team at Union High School.

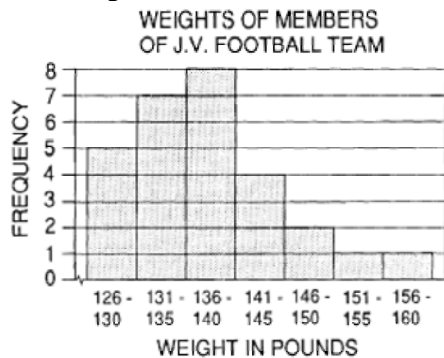

- a. On your answer paper, copy and complete the tables below using the data shown in the frequency histogram. [4]

Interval	Frequency
156-160	
151-155	
146-150	
141-145	
136-140	
131-135	
126-130	5

Interval	Cumulative Frequency
126-160	
126-155	
126-150	
126-145	
126-140	
126-135	
126-130	5

- b. Which interval of the frequency table contains the upper quartile? [2]
c. If one member of the team is selected at random, What is the probability the member will weigh less than 146 pounds? [2]
d. What percent of the team weighs at least 141 pounds but less than 156 pounds? [2]

- 166 1990_08_S1_41 Systems: Writing
A jar contains white marbles and blue marbles only. The number of white marbles is three more than twice the number of blue marbles. The ratio of the number of blue marbles to the total number of marbles in the jar is 2:7. Find the number of marbles in the jar. [Only an algebraic solution will be accepted.] [5,5]

- 167 1990_08_S1_42 Area and the Coordinate Plane
a. On graph paper, plot and label the points $A(1,3)$, $B(3,7)$, and $C(8,7)$. [1]
b. If D has coordinates $(12,y)$, find the value of y such that $ABCD$ is a trapezoid. [2]
c. Find the area of trapezoid $ABCD$. [5]
d. If diagonal AC is drawn, what is the area of $\triangle ADC$? [2]

S1 - The Sequential Course I Curriculum (2000)

- 168 2000_01_S1_01 Equations and Expressions: Using Substitution in

If $x = 3$ and $y = 2$, evaluate x^2y .

- 169 2000_01_S1_02 Equations: Simple with Decimals

Solve for y : $2.5(y + 2) - 1.5y = 6$

- 170 2000_01_S1_03 Combinatorics: Multiplication Counting Principle

Hal has 5 pairs of shorts, 12 shirts, and 2 pairs of sandals. What is the total number of different outfits of a pair of shorts, a shirt, and a pair of sandals that he can wear'?

- 171 2000_01_S1_04 Polynomials: Addition and Subtraction of

The sides of a triangle are represented by $2a$, $3a - 4b$, and $a + 2b$. Express the perimeter of the triangle as a binomial in terms of a and b .

- 172 2000_01_S1_05 Quadratics: Difference of Perfect Squares

Factor: $x^2 - 25$

- 173 2000_01_S1_06 Parallel Lines: Angles Involving

In the accompanying diagram, transversal t intersects parallel lines a and b , $m\angle 1 = 4x + 10$, and $m\angle 2 = 14x - 30$. Find the value of x .

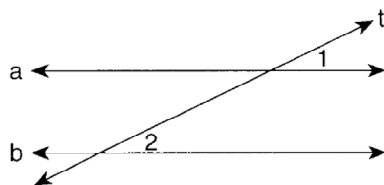

- 174 2000_01_S1_07 Equations: Literal

Solve for p in terms of x , y , and c : $cp - x = y$

- 175 2000_01_S1_08 Equations: Simple

Solve for y : $2(5 - y) = 5(y - 5)$

- 176 2000_01_S1_09 Proportions

An astronaut weighs 174 pounds on Earth and 29 pounds on the Moon. If his daughter weighs 108 pounds on Earth, what is the daughter's weight on the Moon, in pounds?

- 177 2000_01_S1_10 Triangles: Interior and Exterior Angles of

The number of degrees in the measures of the angles of a triangle are represented by x , $3x + 7$, and $4x + 5$. Find the value of x .

- 178 2000_01_S1_11 Symmetry

Each letter in the word "MATH" is printed on a separate card. What is the probability of randomly selecting a card with a letter that has line symmetry'?

- 179 2000_01_S1_12 Triangles: Pythagoras

In the accompanying diagram, $ABCD$ is a rectangle. If $DB = 10$ and $DC = 8$, find BC .

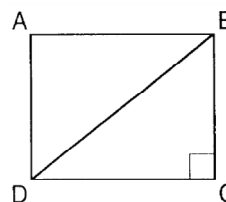

- 180 2000_01_S1_13 Percent

In a basketball game, 15 of 20 foul shots that Michelle attempted were successful. What percent of her shots were *not* successful'?

- 181 2000_01_S1_14 Exponents: Operations with

The expression $\frac{15x^3y^2}{3xy}$, $x \neq 0$, $y \neq 0$, is equivalent

to

- (1) $5x^2y$
- (2) $5x^4y^3$
- (3) $12x^2y$
- (4) $18x^4y^3$

- 182 2000_01_S1_15 Probability: Theoretical
In the accompanying graph, the color of the pants worn by the students in a class is shown.

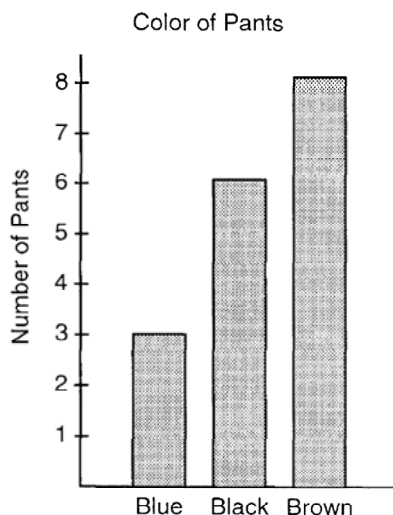

What is the probability that a student selected at random from the class is wearing black pants?

- (1) $\frac{1}{2}$
 (2) $\frac{1}{3}$
 (3) $\frac{6}{6}$
 (4) $\frac{6}{17}$
- 183 2000_01_S1_16 Combinatorics: Permutations
The value of $5!$ is
- (1) 20
 (2) 60
 (3) 80
 (4) 120
- 184 2000_01_S1_17 Logical Reasoning: Symbolic Logic
If p is true and q is false, which statement must also be true?
- (1) $p \wedge q$
 (2) $p \wedge \sim q$
 (3) $p \rightarrow q$
 (4) $\sim p \vee q$

- 185 2000_01_S1_18 Radicals: Operations with
The sum of $2\sqrt{3}$ and $\sqrt{27}$ is

- (1) $11\sqrt{3}$
 (2) $3\sqrt{30}$
 (3) $5\sqrt{3}$
 (4) $4\sqrt{3}$

- 186 2000_01_S1_19 Numbers: Properties of Real
Which expression represents a rational number?

- (1) π
 (2) $\sqrt{3}$
 (3) $\sqrt{7}$
 (4) $\sqrt{16}$

- 187 2000_01_S1_20 Transformations: Classifications of
Which transformation is represented by the illustration?

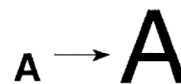

- (1) reflection
 (2) dilation
 (3) translation
 (4) rotation

- 188 2000_01_S1_21 Rationals: Undefined

Which value for n will make the expression $\frac{6}{2n+4}$ undefined?

- 189 2000_01_S1_22 Logical Reasoning: Symbolic Logic
If the converse of a given statement is $q \rightarrow \sim p$, what is the given statement?
- (1) $p \rightarrow \sim q$
 (2) $\sim q \rightarrow p$
 (3) $\sim p \rightarrow q$
 (4) $\sim q \rightarrow \sim p$

- 190 2000_01_S1_23 Systems: Linear
Which ordered pair is the solution of this system of equations?

$$3x + 2y = 4$$

$$-2x + 2y = 24$$

- (1) (-4,8)
- (2) (-4,-8)
- (3) (2,-1)
- (4) (2,-5)

- 191 2000_01_S1_24 Factors: Greatest Common
The greatest common monomial factor of $12x^2$ and $8x^2$ is

- (1) $96x^5$
- (2) $12x^2$
- (3) $8x^3$
- (4) $4x^2$

- 192 2000_01_S1_25 Polynomials: Multiplication and Division of
The expression $(3x + 4)(2x - 6)$ is equivalent to

- (1) $6x^2 - 24$
- (2) $6x^2 - 10x - 24$
- (3) $3x^2 - 12x - 24$
- (4) $2x^2 + 8x - 24$

- 193 2000_01_S1_26 Numbers: Properties of Real
What is the multiplicative inverse of $-\frac{5}{6}$?

- (1) 1
- (2) $\frac{6}{5}$
- (3) $-\frac{6}{5}$
- (4) $\frac{5}{6}$

- 194 2000_01_S1_27 Central Tendency
In which set of data is the mean greater than the median?

- (1) 2,5,6,8,8
- (2) 2,3,5,6,7,8
- (3) 2,4,5,6,6,7
- (4) 2,4,4,5,6,7,8

- 195 2000_01_S1_28 Rationals: Addition and Subtraction of
The sum of $\frac{4x}{5}$ and $\frac{2\pi}{3}$ is

- (1) $\frac{8x^2}{15}$
- (2) $\frac{22x}{15}$
- (3) $\frac{6x}{8}$
- (4) $\frac{22x}{8}$

- 196 2000_01_S1_29 Circles: Area of
If the circumference of a circle is 8π , what is the area of the circle?

- (1) 64π
- (2) 8π
- (3) 16π
- (4) 4π

- 197 2000_01_S1_30 Slope Intercept Form of a Line
The diagram below shows the graph of line m .

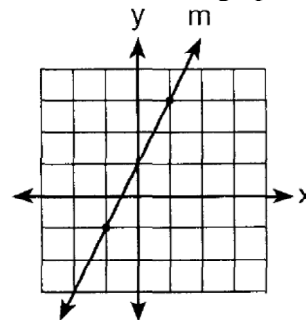

Which equation represents this line?

- (1) $y = 2x + 1$
- (2) $y = \frac{1}{2}x + 2$
- (3) $y = -2x + 1$
- (4) $y = -\frac{1}{2}x + 2$

- 198 2000_01_S1_31 Solid Geometry: Prisms and Cylinders
A rectangular prism (solid) has a length of 5 feet, a width of 4 feet, and a height of 3 feet. The number of square feet in the area of a face of the prism can *not* be
- (1) 9
 - (2) 12
 - (3) 15
 - (4) 20

- 199 2000_01_S1_32 Special Quadrilaterals: Trapezoids
Which quadrilateral has only one pair of parallel sides?
parallelogram
- (1) parallelogram
 - (2) rectangle
 - (3) rhombus
 - (4) trapezoid

- 200 2000_01_S1_33 Quadratics: Solving by Factoring
What is the solution set of the equation $x^2 - 2x - 3 = 0$?
- (1) {3,-1}
 - (2) {-3,1}
 - (3) {-3,-1}
 - (4) {3,1}

- 201 2000_01_S1_34 Slope
The slope of the graph of the equation $x = 3$ is
- (1) 1
 - (2) 0
 - (3) 3
 - (4) undefined

- 202 2000_01_S1_35 Complementary, Supplementary and Vertical Angles
Two supplementary angles are in the ratio 5:4. The number of degrees in the *smaller* angle is
- (1) 100
 - (2) 80
 - (3) 40
 - (4) 20

- 203 2000_01_S1_36 Logical Reasoning: Symbolic Logic
Let p represent: " $ABCD$ is a square."
Let q represent: " $ABCD$ is a parallelogram."
- a. Using p and q , write this statement in symbolic form: "If $ABCD$ is a square, then $ABCD$ is a parallelogram." [1]
 - b. Write the inverse of the statement in part a in symbolic form. [2]
 - c. Construct a truth table for each statement written in parts a and b. [7]

- 204 2000_01_S1_37 Graphic Representation: Histograms and Tables
The chart below shows the result of a survey taken of one section of an arena at a concert. People were asked their ages as they were seated.
- a. Construct a frequency histogram for the frequency table below. [4]

Age	Frequency
0-5	18
6-10	23
11-15	12
16-20	8
21-25	12
26-30	15
31-35	7
36-40	5

- b. What is the total number of people who were less than 16 years old? [2]
 - c. What is the probability that a person chosen at random is older than 25? [2]
 - d. Which interval contains the median? [2]
- 205 2000_01_S1_38 Area and the Coordinate Plane
- a. On the same set of coordinate axes, graph the following lines.
 - (1) $y = 2$ [1]
 - (2) $y = 6$ [1]
 - (3) $y = 2x + 12$ [3]
 - (4) $y = 2x - 12$ [3]
 - b. Find the area of the parallelogram formed by these lines. [2]

- 206 2000_01_S1_39 Polygons and Circles: Inscribed
 In the accompanying diagram, isosceles right triangle ACB is inscribed in a semicircle with a diameter of length 32. Find the area of the shaded region in terms of n . [10]

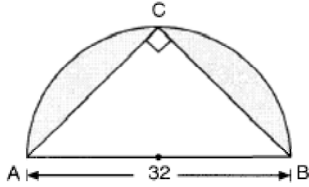

- 207 2000_01_S1_40 Probability: Dependent Events
 There are only three flavors of gumdrops in a jar containing 40 gumdrops. There are 3 times as many cherry gumdrops as lemon gumdrops. There are 4 more than twice as many orange gumdrops as lemon gumdrops.
- How many gumdrops of each flavor are in the jar? [Only an algebraic solution will be accepted.] [6]
 - Two gumdrops are drawn at random without replacement. Find the probability that both are the same flavor. [4]

- 208 2000_01_S1_41 Quadratics: Writing
 At the Happyland Day Care Center, the length of the rectangular sandbox is 4 feet longer than the width.
- Find the number of feet in the length and the width of the sandbox if the area is 140 square feet. [Only an algebraic solution will be accepted.] [8]
 - Find the number of feet in the perimeter of the sandbox. [2]

- 209 2000_01_S1_42 Systems: Writing
 The senior class at Northwest High School needed to raise money for the yearbook. A local sporting goods store donated hats and T-shirts. The number of T-shirts was three times the number of hats. The seniors charged \$5 for each hat and \$8 for each T-shirt. If the seniors sold everything and raised \$435, what was the total number of hats and the total number of T-shirts that were sold? [Show or explain the procedure used to obtain your answer.] [10]

- 210 2000_06_S1_01 Combinatorics: Multiplication Counting Principle
 Allison purchased 4 shirts and a number of pairs of slacks. Using these shirts and slacks, she can wear 20 different outfits consisting of a shirt and a pair of slacks. How many slacks did she buy?

- 211 2000_06_S1_02 Parallel Lines: Angles Involving
 In the accompanying diagram, parallel lines l and m are cut by transversal t at a 45° angle. Find the number of degrees in the measure of angle x .

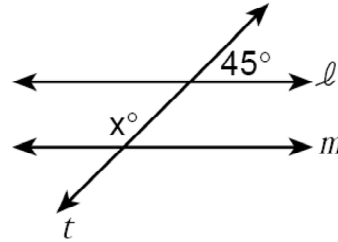

- 212 2000_06_S1_03 Graphic Representation of Data
 The accompanying circle represents the 2400 students at Central High School, and the shaded portion represents the freshman class. What is the total number of students in the freshman class?

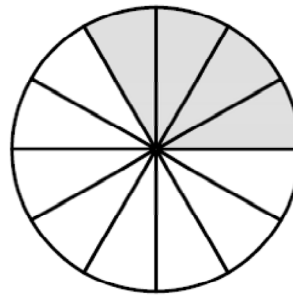

- 213 2000_06_S1_04 Similarity
 In the accompanying diagram, $\triangle ABC$ is similar to $\triangle DEF$, $AC = 3$, $CB = 5$, and $DF = 9$. Find FE .

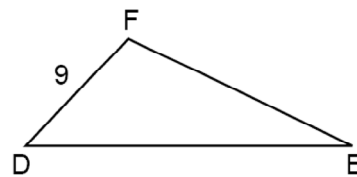
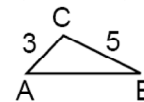

214 2000_06_S1_05 Equations: Simple
Solve for y : $6y - 4 = 2y + 10$

215 2000_06_S1_06 Perimeter
The perimeter of a regular pentagon is 60. What is the length of one side of the pentagon?

216 2000_06_S1_07 Equations and Expressions: Using Substitution in
The formula for changing Celsius (C) temperature to Fahrenheit (F) temperature is $F = 1.8C + 32$. What is the number of degrees in the value of C when $F = 68^\circ$?

217 2000_06_S1_08 Triangles: Interior and Exterior Angles of
In the accompanying diagram, \overline{AC} is extended from C through D , $m\angle BCD = 140$, and $m\angle B = 80$. Find $m\angle BAC$.

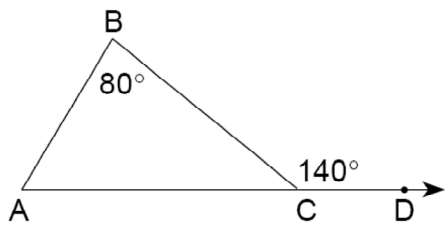

218 2000_06_S1_09 Graphic Representation: Histograms and Tables
The table below shows the distribution of bowling scores. In which interval does the median lie?

Interval	Frequency
91–110	10
111–130	11
131–150	8
151–170	4
171–190	6
191–210	5

219 2000_06_S1_10 Systems: Linear
Solve this system of equations for x :
 $2x - 3y = 10$
 $x + 3y = 14$

220 2000_06_S1_11 Slope Intercept Form of a Line
What is the y -intercept of the line whose equation is $y = 7x + 5$?

221 2000_06_S1_12 Circles: Center, Radius and Circumference
The radius of a circle is represented by $3x + 2$, and the length of the diameter is 22 centimeters. Find the value of x , in centimeters.

222 2000_06_S1_13 Triangles: Pythagoras
The hypotenuse of a right triangle is 26 centimeters and one leg is 24 centimeters. Find the number of centimeters in the second leg.

223 2000_06_S1_14 Exponential Functions and Equations
Solve for the positive value of x : $\frac{1}{4}x^2 = 16$

224 2000_06_S1_15 Scientific Notation
If 0.000043 is expressed as 4.3×10^n , what is the value of n ?

225 2000_06_S1_16 Area and the Coordinate Plane
What is the area of $\triangle ABC$ as shown in the accompanying diagram?

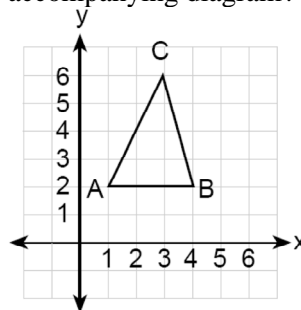

226 2000_06_S1_17 Triangles: Isosceles
If a base angle of an isosceles triangle measures 50° , what is the number of degrees in the measure of the vertex angle?

227 2000_06_S1_18 Combinatorics: Permutations
A different plant is placed on each of the four corners of a square patio. Which expression would be used to find the number of different ways the four plants can be arranged?

- (1) ${}_4P_1$
- (2) ${}_4P_2$
- (3) ${}_2P_4$
- (4) ${}_4P_4$

- 228 2000_06_S1_19 Polynomials: Factoring
Which expression is equivalent to $x^2 + 7x + 6$?
- (1) $(x + 6)(x + 1)$
 - (2) $(x + 3)(x + 2)$
 - (3) $(x + 1)(x + 7)$
 - (4) $x(x + 7)$

- 229 2000_06_S1_20 Probability: Theoretical
In the accompanying diagram, the circle is divided into six equal parts. If the pointer is spun once, what is the probability that the pointer will land on a number divisible by 3?

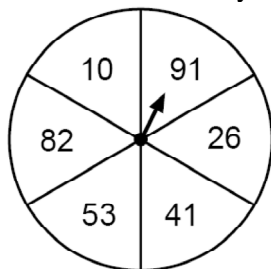

- (1) 1
 - (2) $\frac{2}{6}$
 - (3) $\frac{1}{6}$
 - (4) 0
- 230 2000_06_S1_21 Central Tendency
The numbers in a distribution are represented by $3x$, $x + 2$, $2x$, and $x - 5$. If $x = 2$, then the mode of these numbers is
- (1) 6
 - (2) 2
 - (3) -3
 - (4) 4
- 231 2000_06_S1_22 Numbers: Properties of Real
Which property is illustrated by the equation $3(x + 4) = 3x + 12$?
- (1) associative property of addition
 - (2) commutative property of addition
 - (3) distributive property of multiplication over addition
 - (4) transitive property of equality

- 232 2000_06_S1_23 Central Tendency
Nine students scored 75 or less on a mathematics test. If 75 is the 25th percentile, what is the number of students who took this test?
- (1) 6
 - (2) 12
 - (3) 36
 - (4) 45

- 233 2000_06_S1_24 Exponents: Operations with
If the area of a rectangle is represented by $8x^3y^6$ and the width is represented by $2xy^2$, the length is represented by
- (1) $4x^2y^4$
 - (2) $6x^2y^4$
 - (3) $4x^2y^3$
 - (4) $6x^2y^3$

- 234 2000_06_S1_25 Rationals: Addition and Subtraction of
The sum of $\frac{5x}{2}$ and $\frac{3x}{5}$ is
- (1) $\frac{8x}{7}$
 - (2) $\frac{8x}{10}$
 - (3) $\frac{15x}{10}$
 - (4) $\frac{31x}{10}$

- 235 2000_06_S1_26 Order of Operations
The expression $5(x - 3) - 4(x - 3)$ is equivalent to
- (1) 1
 - (2) $x - 3$
 - (3) $x - 6$
 - (4) $x - 27$

- 236 2000_06_S1_27 Symmetry
Which letter has horizontal but does not have vertical line symmetry?
- (1) **B**
 - (2) **W**
 - (3) **O**
 - (4) **N**

- 237 2000_06_S1_28 Inequalities: Linear
Which graph illustrates the relationship $x + y \leq 4$?

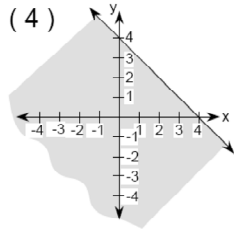
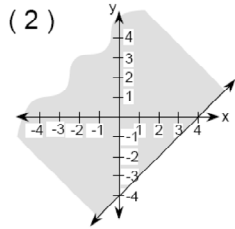
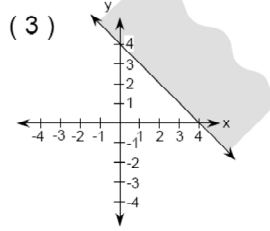
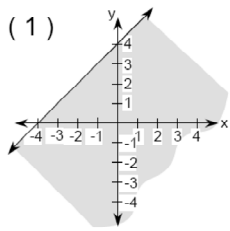

- 238 2000_06_S1_29 Logical Reasoning: Symbolic Logic
Which statement is always true?

- (1) $p \wedge \sim p$
- (2) $p \vee \sim p$
- (3) $p \rightarrow \sim p$
- (4) $p \leftrightarrow \sim p$

- 239 2000_06_S1_30 Rationals: Undefined
Which of these expressions is undefined when $x = 5$?

- (1) $\frac{x-5}{1}$
- (2) $\frac{-5-x}{1}$
- (3) $\frac{1}{x-5}$
- (4) $x-5$

- 240 2000_06_S1_31 Radicals: Simplifying
The expression $2\sqrt{2} - \sqrt{50}$ is equivalent to

- (1) $\sqrt{48}$
- (2) $-3\sqrt{2}$
- (3) $-7\sqrt{2}$
- (4) $5\sqrt{2}$

- 241 2000_06_S1_32 Transformations: Classifications of
Triangle $A'B'C'$ is the image of $\triangle ABC$ under a given transformation. If $\triangle A'B'C'$ is similar but not congruent to $\triangle ABC$, the transformation must be a

- (1) dilation
- (2) line reflection
- (3) rotation
- (4) translation

- 242 2000_06_S1_33 Volume
A cube whose edge has a length of 4 has the same volume as a rectangular box whose length is 8 and whose width is 4. The height of the rectangular box is

- (1) 1
- (2) 2
- (3) 3
- (4) 4

- 243 2000_06_S1_34 Exponents

What is the value of $\frac{3}{4} \left(\frac{2}{3} \right)^0$?

- (1) 1
- (2) $\frac{4}{3}$
- (3) $\frac{3}{4}$
- (4) $\frac{6}{12}$

- 244 2000_06_S1_35 Transformations: Classifications of
Which transformation is shown in the accompanying diagram?

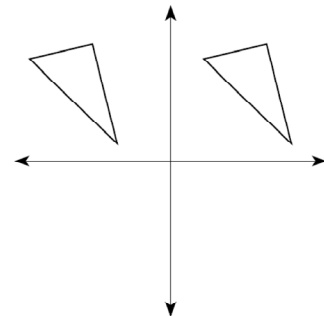

- (1) reflection
- (2) translation
- (3) rotation
- (4) dilation

- 245 2000_06_S1_36 Equations: Graphing
- a. On the same set of coordinate axes, graph the lines of the following equations.
- (1) $y - 2x = 1$ [3]
 - (2) $3x + y = 6$ [3]
 - (3) $y = -3$ [2]
- b. Write the coordinates of all the vertices of the triangle formed by the lines graphed in part a. [2]

- 246 2000_06_S1_37 Logical Reasoning: Symbolic Logic
- a. On your answer paper, construct and complete a truth table for the statement $(\sim p \wedge q) \leftrightarrow (p \vee q)$. [9]
- b. Based on the truth table completed in part a, is the statement $(\sim p \wedge q) \leftrightarrow (p \vee q)$ a tautology? [1]

- 247 2000_06_S1_38 Systems: Writing
- Cedric and Zelda went shopping at Price Buster. Cedric bought 2 jumbo rolls of aluminum foil and 3 packages of AA batteries for a total cost of \$21. Zelda bought 5 identical jumbo rolls of aluminum foil and 2 identical packages of AA batteries for a total cost of \$25. Find the cost of 1 roll of aluminum foil and find the cost of 1 package of AA batteries. [Only an algebraic solution will be accepted.] [10]

- 248 2000_06_S1_39 Triangles: Interior and Exterior Angles of
- The measures of the angles of $\triangle ABC$ are represented by $x^2 + 5$, $6x - 3$, and $x + 8$.
- a. Find the measure of each angle of this triangle. [Only an algebraic solution will be accepted.] [8]
 - b. Which type of triangle is $\triangle ABC$? [2]

- 249 2000_06_S1_40 Systems: Writing
- A bank contains 30 coins, consisting of nickels, dimes, and quarters. There are twice as many nickels as quarters and the remaining coins are dimes. If the total value of the coins is \$3.35, what is the number of each type of coin in the bank? [Show or explain the procedure used to obtain your answer.] [10]

- 250 2000_06_S1_41 Probability: Sample Space

The accompanying diagram shows two roads that lead from Town B to Town L and four roads that go from Town L to Town M. The numbers in parentheses show the distances between each of these towns.

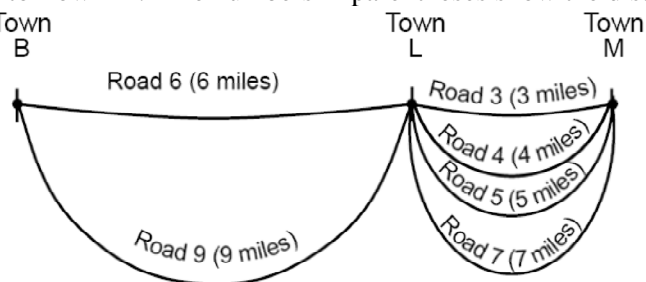

- a. Draw a tree diagram or list the sample space showing all possible routes from Town B to Town M. [4]
- b. Bonnie traveled from Town B to Town M, passing through Town L. Find the probability that
 - (1) both roads she chose are odd-numbered roads [2]
 - (2) the total distance in miles from Town B to Town M is a prime number [2]
 - (3) the distance from Town B to Town M is less than 9 miles [2]

251 2000_06_S1_42 Polygons and Circles: Inscribed

In the accompanying diagram, right triangle ABC , with the right angle at B , is inscribed in circle O , \overline{AC} is a diameter, $AB = 6$ centimeters, and $BC = 8$ centimeters. Find the area of the shaded region to the nearest tenth of a square centimeter. [10]

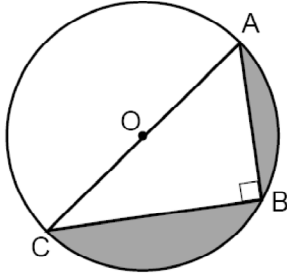

252 2000_08_S1_01 Equations: Simple

Solve for x : $5x + 2x - 4 = 4x + 5$

253 2000_08_S1_02 Special Quadrilaterals: Rectangles and Squares

In the accompanying diagram of rectangle $ABCD$, diagonal $AC = 8x + 4$ and diagonal $BD = 5x + 16$. Find the value of x .

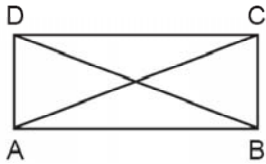

254 2000_08_S1_03 Probability: Mutually Exclusive Events

If the probability of rain is $\frac{6}{10}$, what is the probability that it will *not* rain?

255 2000_08_S1_04 Graphic Representation: Histograms and Tables

The accompanying histogram shows the results of a survey of the number of hours a group of teenagers listened to their CD players each day. What is the total number of teenagers who were surveyed?

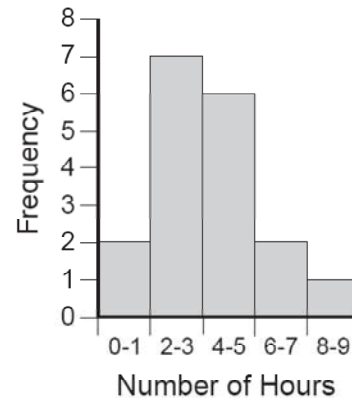

256 2000_08_S1_05 Rationals: Solving

Solve for x : $\frac{4}{3}x - 6 = 10$

257 2000_08_S1_06 Combinatorics: Permutations

Express $\frac{5!}{3!}$ as a whole number.

258 2000_08_S1_07 Equations: Literal

Solve for a in terms of b , c , and d :
 $ab + c = d$

259 2000_08_S1_08 Parallel Lines: Angles Involving

In the accompanying diagram, parallel lines \overleftrightarrow{EF} and \overleftrightarrow{GH} are cut by transversal \overleftrightarrow{LM} at N and P , respectively. If $m\angle LNF = 54$, find $m\angle NPG$.

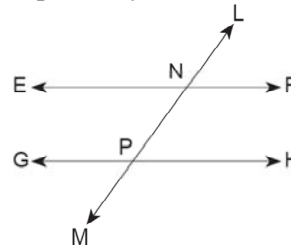

- 260 2000_08_S1_09 Triangles: Interior and Exterior Angles of
In the accompanying diagram of isosceles triangle ABC , $AB \cong BC$, AC is extended to D , and $m\angle A = 42$. Find $m\angle BCD$.

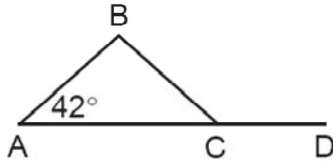

- 261 2000_08_S1_10 Exponential Functions and Equations
Solve for the positive value of x : $x^2 - 49 = 0$
- 262 2000_08_S1_11 Area and the Coordinate Plane
What is the area of figure $ABCD$ that is formed by coordinates $A(0,0)$, $B(5,0)$, $C(5,3)$, and $D(0,3)$?
- 263 2000_08_S1_12 Logical Reasoning: Symbolic Logic
Write, in symbolic form, the converse of $\sim p \rightarrow q$.
- 264 2000_08_S1_13 Variation: Direct
If x varies directly as y and $x = 3$ when $y = 8$, what is the value of y when $x = 9$?
- 265 2000_08_S1_14 Systems: Linear
Solve the following system of equations for x :
 $-3x + 2y = 18$
 $2y = 3$
- 266 2000_08_S1_15 Identifyig Transformations
Which transformation for $\triangle RST$ is shown in the accompanying diagram?

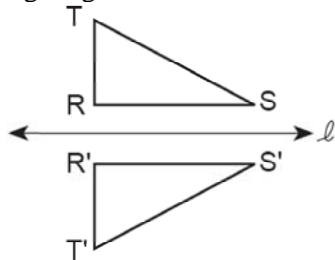

- (1) line reflection
(2) rotation
(3) translation
(4) dilation

- 267 2000_08_S1_16 Consecutive Integers
If $w + 5$ represents an even integer, the next *smaller* even integer is represented by
(1) $2w - 5$
(2) $2w + 5$
(3) $w + 7$
(4) $w + 3$
- 268 2000_08_S1_17 Polynomials: Addition and Subtraction of
What is the sum of $5x - 6y + z$ and $5x - 6y - z$?
(1) $10x - 12y + 2z$
(2) $10x - 12y$
(3) $10x + 12y - z$
(4) $10x + 12y$
- 269 2000_08_S1_18 Central Tendency: Average Known with Missing Data
Rick's recorded times in four 1-mile runs are 4.8 minutes, 5.3 minutes, 4.7 minutes, and 5.4 minutes. For Rick's next run, which time will give him a mean of 5.0 minutes?
(1) 4.8 min
(2) 5.3 min
(3) 5.7 min
(4) 6.0 min
- 270 2000_08_S1_19 Polynomials: Multiplication and Division of
The product of $(2x - 3)(3x + 5)$ is equivalent to
(1) $5x^2 - x - 15$
(2) $6x^2 + x + 15$
(3) $5x + 2$
(4) $6x^2 + x - 15$

- 271 2000_08_S1_20 Numbers: Properties of Real
Which property is demonstrated by the following equation?
 $a(b + c) = ab + ac$
(1) associative property of addition
(2) distributive property
(3) commutative property of addition
(4) identity property of addition

- 272 2000_08_S1_21 Combinatorics: Permutations
 What is the total number of different six-letter arrangements that can be formed from the letters in the word "FOREST" if each letter is used only once in each arrangement?
- (1) 1
 - (2) 6
 - (3) 720
 - (4) 46,656

- 273 2000_08_S1_22 Slope Intercept Form of a Line
 What is the y-intercept of the line whose equation is $y = 6x - 7$?
- (1) -6
 - (2) 6
 - (3) 7
 - (4) -7

- 274 2000_08_S1_23 Inequalities: Linear
 Which inequality is equivalent to $2x - 1 > 5$?
- (1) $x > 6$
 - (2) $x > 2$
 - (3) $x < 3$
 - (4) $x > 3$

- 275 2000_08_S1_24 Polynomials: Factoring
 One factor of $x^2 + 5x - 24$ is
- (1) $x - 8$
 - (2) $x - 6$
 - (3) $x - 3$
 - (4) $x + 4$

- 276 2000_08_S1_25 Rationals: Addition and Subtraction of
 What is the sum of $\frac{6x}{7}$ and $\frac{2x}{5}$, expressed as a single fraction in lowest terms?
- (1) $\frac{8x}{35}$
 - (2) $\frac{12x}{35}$
 - (3) $\frac{44x}{35}$
 - (4) $\frac{44x}{12}$

- 277 2000_08_S1_26 Complementary, Supplementary and Vertical Angles
 In two supplementary angles, the measure of one angle is 6 more than twice the measure of the other. The measures of these two angles are
- (1) 28° and 62°
 - (2) 32° and 58°
 - (3) 58° and 122°
 - (4) 62° and 118°

- 278 2000_08_S1_27 Logical Reasoning: Symbolic Logic
 In the truth table below, which statement is the correct heading for column 4?

Column 1	Column 2	Column 3	Column 4
p	q	$\sim p$?
T	T	F	F
T	F	F	F
F	T	T	T
F	F	T	F

- (1) $\sim p \vee q$
 - (2) $\sim p \wedge q$
 - (3) $\sim p \rightarrow q$
 - (4) $q \leftrightarrow \sim p$
- 279 2000_08_S1_28 Polygons: Area of
 In terms of x , what is the area of the rectangle shown below?
- $(x + 3)$

x
- (1) $x^2 + 3x$
 - (2) $2x + 3$
 - (3) $4x + 6$
 - (4) $5x$
- 280 2000_08_S1_29 Volume
 What is the volume of a cube whose edge has a length of 4?
- (1) 12
 - (2) 24
 - (3) 64
 - (4) 96

- 281 2000_08_S1_30 Circles: Center, Radius and Circumference
 If the circumference of a circle is 36π , what is the length of a radius of the circle?
 (1) 6
 (2) 18
 (3) 36
 (4) 72

- 282 2000_08_S1_31 Rationals: Undefined
 For which value of x is the expression $\frac{4x}{x+6}$ undefined?
 (1) 0
 (2) 2
 (3) 6
 (4) -6

- 285 2000_08_S1_34 Inequalities: Linear
 Which graph represents the inequality $x \leq 2$?

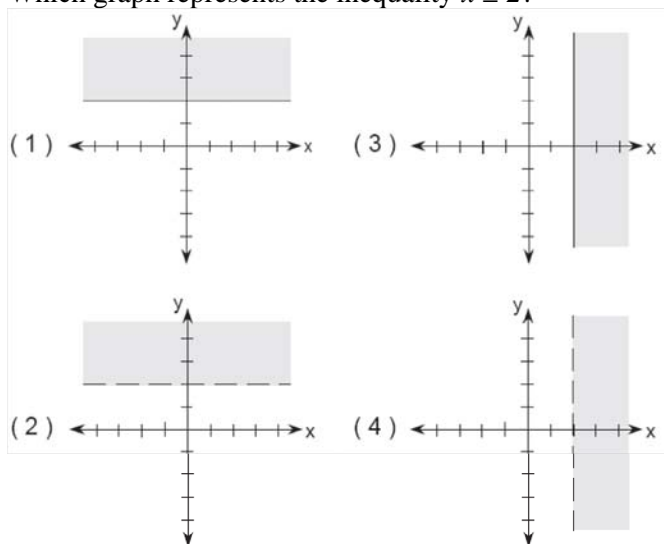

- 286 2000_08_S1_35 Symmetry
 Which figure does *not* always possess line symmetry?
 (1) square
 (2) rectangle
 (3) circle
 (4) parallelogram

- 283 2000_08_S1_32 Exponents: Operations with
 Which monomial is equivalent to $(7x^4)^2$?
 (1) $49x^6$
 (2) $49x^8$
 (3) $14x^6$
 (4) $14x^8$

- 284 2000_08_S1_33 Triangles: Pythagoras
 The length of the hypotenuse of a right triangle is 7, and the length of one leg is 4. What is the length of the other leg?
 (1) $\sqrt{33}$
 (2) 33
 (3) $\sqrt{65}$
 (4) 65

- 287 2000_08_S1_36 Area and the Coordinate Plane
 a. On the same set of coordinate axes, graph the following system of equations.
 $y = -4$ [2]
 $2x + y = 6$ [4]
 b. Find the area of the trapezoid bounded by the x -axis, the y -axis, and the graphs drawn in part a. [4]

- 288 2000_08_S1_37 Polygons and Circles: Inscribed
 In the accompanying diagram, rectangle $MATH$ is inscribed in circle O . The length of radius OT is 5 centimeters and the length of TH is 6 centimeters.

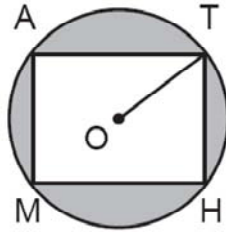

- a. Find the length of in centimeters. [3]
 b. Find the area of the shaded region to the nearest square centimeter. [7]
- 289 2000_08_S1_38 Probability: Dependent Events
 There are four coins in a jar: a penny, a nickel, a dime, and a quarter. One coin is removed at random. Without replacing the first coin, a second coin is removed.
- a. Draw a tree diagram or list the sample space showing all the possible outcomes. [4]
 b. Find the probability that the total value of the two coins selected is
 (1) 11 cents [2]
 (2) greater than 35 cents [2]
 (3) at most 30 cents [2]

- 293 2000_08_S1_42 Logical Reasoning: Symbolic Logic
- a. Each set below consists of three sentences. Assume that the first two sentences are true. *On your answer paper*, write the truth value “true” or “false” for the third sentence in each set. If the truth value cannot be determined from the given information, write “cannot be determined.” [2,2]
- (1) If Chris gets her homework done, then she will go to the volleyball game.
 Chris goes to the volleyball game.
 Chris gets her homework done.
- (2) I do not study and I do not pass my test.
 I do not study.
 I pass my test

b. *On your answer paper*, copy and complete the truth table for the statement $\sim (p \wedge q) \rightarrow \sim q$. [6]

p	q	$p \wedge q$	$\sim(p \wedge q)$	$\sim q$	$\sim(p \wedge q) \rightarrow \sim q$
T	T				
T	F				
F	T				
F	F				

- 290 2000_08_S1_39 Systems: Writing
 The sum of two integers is 10, and the sum of their squares is 250. Find the two integers. [*Only an algebraic solution will be accepted.*] [4,6]
- 291 2000_08_S1_40 Systems: Linear
 Solve the following system of equations algebraically and check.
 $0.7x + 0.4y = 16$
 $x + y = 10$ [8,2]
- 292 2000_08_S1_41 Inequalities: Writing Systems of
 A museum sold 50 more adult tickets at \$6.50 each than children’s admission tickets at \$5.50 each. What is the minimum number of *each* type of ticket that the cashier had to sell for the total receipts to be *at least* \$1000? [*Show or explain the procedure used to obtain your answer.*] [10]

S2 - The Sequential Course II Curriculum (1980-1990)

- 1 1980_01_S2_01 Similarity

In the accompanying diagram, $\triangle ABC$, D is a point on \overline{BA} , and E is a point on \overline{BC} such that $\overline{DE} \parallel \overline{AC}$. If $\overline{BD} = 4$, $\overline{BA} = 10$, and $\overline{BC} = 20$, what is the length of \overline{BE} ?

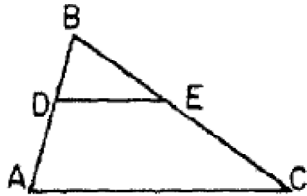

- 2 1980_01_S2_02 Special Quadrilaterals: Parallelograms

In parallelogram $ABCD$, $\overline{AB} = 5x - 4$ and $\overline{CD} = 2x + 14$. Find the value of x .

- 3 1980_01_S2_03 Proofs: Coordinate

Quadrilateral $ABCD$ is a rectangle. The coordinates of A , B , and C are $A(5,0)$, $B(0,0)$, $C(0,-6)$. What are the coordinates of point D ?

- 4 1980_01_S2_04 Parallel Lines: Angles Involving

In the accompanying diagram, \overline{AB} is parallel to \overline{CD} and both lines are intersected by transversal \overline{EF} . If $m\angle BEF$ is twice $m\angle DFE$, find $m\angle DFE$.

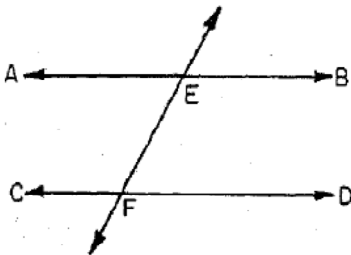

- 5 1980_01_S2_05 Triangles: Mean Proportionals

In the accompanying diagram, $\triangle ABC$ is a right triangle with right angle at C and $\overline{CD} \perp \overline{AB}$ at D . If $\overline{AB} = 8$ and $\overline{AC} = 4$, find \overline{AD} .

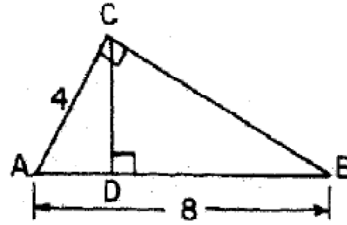

- 6 1980_01_S2_06 Slope

Find the slope of the line which passes through the points whose coordinates are $(-2,5)$ and $(3,9)$.

- 7 1980_01_S2_07 Triangles: Equilateral

Express in radical form the length of an altitude of an equilateral triangle whose side has length 10.

- 8 1980_01_S2_08 Midpoint

Point M is the midpoint of \overline{CD} . The coordinates of C are $(5,-3)$ and the coordinates of M are $(5,7)$. What are the coordinates of D ?

- 9 1980_01_S2_09 Parallel and Perpendicular Lines

Write an equation of the line which passes through the origin and is perpendicular to $y = -\frac{3}{4}x + 7$.

- 10 1980_01_S2_10 Special Quadrilaterals: Rhombuses

The length of each side of a rhombus is 13. If the length of the shorter diagonal is 10, find the length of the longer diagonal.

- 11 1980_01_S2_11 Equations: Forming Quadratics from Roots

The roots of a quadratic equation are $x = 2$ and $x = -5$. Write its equation in the form $x^2 + bx + c = 0$.

- 12 1980_01_S2_12 Combinatorics: Permutations

How many different 6-letter permutations are there of the letters in the word "FREEZE"?

- 13 1980_01_S2_13 Combinatorics: Combinations
Three students are chosen to form a committee from the membership of a club of 4 seniors and 6 juniors. How many different committees consisting of 1 senior and 2 juniors can be formed?

- 14 1980_01_S2_14 Combinatorics: Multiplication Counting Principle
A 3-digit numeral is formed by selecting from the digits 1, 2, 5, and 6, with no repetition. What is the probability that the number formed is greater than 500?

- 15 1980_01_S2_15 Numbers: Properties of Real
In the mod 7 (clock 7) system of arithmetic, which member of the set $\{0,1,2,3,4,5,6\}$ does *not* have a multiplicative inverse?

- 16 1980_01_S2_16 Numbers: Properties of Real
Determine the value of $(2 \otimes 4) \otimes (6 \otimes 8)$ within the following system:

\otimes	2	4	6	8
2	4	8	2	6
4	8	6	4	2
6	2	4	6	8
8	6	2	8	4

- 17 1980_01_S2_17 Numbers: Properties of Real
If the operation $*$ is defined as $a * b = a^2 + b$, find the value of $3*5$.

- 18 1980_01_S2_18 Similarity
The sides of a triangle have lengths 6, 8, and 10. What is the length of the *shortest* side of a similar triangle that has a perimeter of 12?
(1) 6
(2) 8
(3) 3
(4) 4

- 19 1980_01_S2_19 Triangles: Interior and Exterior Angles of
The measures of the angles of a triangle are in the ratio 2:3:4. The measure in degrees of the *smallest* angle of the triangle is
(1) 20
(2) 40
(3) 60
(4) 80

- 20 1980_01_S2_20 Special Quadrilaterals: Parallelograms
In parallelogram $ABCD$, diagonals \overline{AC} and \overline{DB} intersect at E . Which statement is always true?
(1) Triangle AED is isosceles.
(2) Triangle ABD is a right triangle.
(3) Triangle AEB is congruent to triangle AED .
(4) Triangle ABC is congruent to triangle CDA .

- 21 1980_01_S2_21 Triangle Inequalities
Which set of numbers could represent the lengths of the sides of a triangle?

- (1) $\{1,2,3\}$
(2) $\{2,4,6\}$
(3) $\{3,5,7\}$
(4) $\{5,10,20\}$

- 22 1980_01_S2_22 Numbers: Properties of Real
Which equation is an illustration of the distributive law?

- (1) $a(b+c) = ab+ac$
(2) $(a+b)+c = a+(b+c)$
(3) $(ab)c = a(bc)$
(4) $ab+ac = ac+ab$

- 23 1980_01_S2_23 Locus
Parallel lines l and m are 4 centimeters apart and P is a point on line l . The total number of points that are equidistant from l and m and also 2 centimeters from point P is
(1) 1
(2) 2
(3) 3
(4) 0

- 24 1980_01_S2_24 Set Theory
A set contains the element a . If $a * x = x$ and $x * a = x$ for every element x in the set, it can be concluded that
- (1) a is the inverse of x
 - (2) a is the identity of the set under $*$
 - (3) the set is closed under $*$
 - (4) x is the identity of the set under $*$
- 25 1980_01_S2_25 Logical Reasoning: Contrapositive
Assume that the statement, "All geniuses have studied geometry," is true. Which statement must also be true?
- (1) Ron has studied geometry; therefore, Ron is a genius.
 - (2) Mary is not a genius; therefore, Mary has not studied geometry.
 - (3) Lance has not studied geometry; therefore, Lance is not a genius.
 - (4) If Lucy studies geometry, Lucy is a genius.
- 26 1980_01_S2_27 Quadratics: Axis of Symmetry
An equation of the axis of symmetry of the parabola $y = ax^2 - 4x + 1$ is $x = 1$. The value of a is
- (1) -2
 - (2) 2
 - (3) -4
 - (4) 4
- 27 1980_01_S2_28 Quadratics: Using the Discriminant
Which parabola touches the x -axis at one point only?
- (1) $y = x^2 + 8x + 16$
 - (2) $y = x^2 - 16$
 - (3) $y = x^2 - 5x + 6$
 - (4) $y = x^2 + 4$
- 28 1980_01_S2_30 Logical Reasoning
Which is the negation of the statement, "Larry is old and Gary is not here"?
- (1) Larry is old and Gary is not here.
 - (2) Larry is not old or Gary is here.
 - (3) Larry is not old and Gary is not here.
 - (4) Larry is old or Gary is here.
- 29 1980_01_S2_31 Quadratics: Solving
One root of the equation $6x^2 - 11x + 5 = 0$ is 1. What is the other root?
- (1) $\frac{2}{5}$
 - (2) $\frac{1}{2}$
 - (3) $\frac{4}{3}$
 - (4) $\frac{5}{6}$
- 30 1980_01_S2_32 Triangles: Interior and Exterior Angles of
If the measures of the angles of a triangle are represented by x , y , and $x + y$, then the triangle is always
- (1) isosceles
 - (2) equilateral
 - (3) right
 - (4) obtuse
- 31 1980_01_S2_33 Proofs: Triangle _____
Triangle ABC is obtuse and $\overline{AB} \cong \overline{BC}$. Which is always true?
- (1) $\triangle ABC$ is equilateral.
 - (2) \overline{CA} is the shortest side.
 - (3) $m\angle A > m\angle B$
 - (4) $CA > AB$
- 32 1980_01_S2_34 Circles: Equations of
An equation of a circle with center at $(2, -3)$ and radius 5 is
- (1) $(x - 2)^2 + (y + 3)^2 = 25$
 - (2) $(x - 2)^2 + (y + 3)^2 = 5$
 - (3) $(x + 2)^2 + (y - 3)^2 = 25$
 - (4) $(x + 2)^2 + (y - 3)^2 = 5$

- 33 1980_01_S2_35 Constructions
On the answer sheet, construct a line through point A parallel to \overleftrightarrow{BC} .

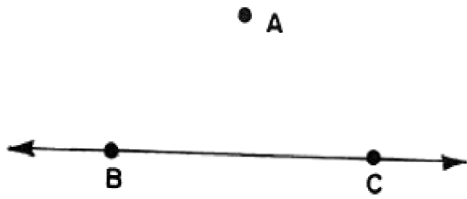

- 34 1980_01_S2_36a Triangles: Equilateral
The vertices of triangle ABC are A(4,4), B(12,10), and C(6,13).
Show that $\triangle ABC$ is not equilateral. [4]

- 35 1980_01_S2_36b Area and the Coordinate Plane
The vertices of triangle ABC are A(4,4), B(12,10), and C(6,13).
Find the area of $\triangle ABC$. [6]

- 36 1980_01_S2_37 Quadratics: Graphing
- Graph $y = x^2 - 3x - 4$ including all integral values of x from -2 to 5. [6]
 - Write an equation for the axis of symmetry of this parabola. [2]
 - What are the roots of $x^2 - 3x - 4 = 0$? [2]

- 37 1980_01_S2_38 Systems: Other Nonlinear
The perimeter of a rectangle is 28 centimeters. If the length of a diagonal of the rectangle is 10 centimeters, find the number of centimeters in the length and width of the rectangle. [Only an algebraic solution will be accepted.] [4,6]

- 38 1980_01_S2_39 Numbers: Properties of Real
The table below represents the operation \square for the set $\{c,d,e,f\}$.

\square	c	d	e	f
c	c	d	e	f
d	d	e	f	c
e	e	f	c	d
f	f	c	d	e

- What is the identity element of this system? [2]
 - What is the inverse of f ? [2]
 - Find the value of $(e \square e) \square d$. [2]
 - Solve for x : $(f \square e) \square x = f$ [2]
 - If h had been an element found within this table in any of the 4 rows, what property of groups would *not* have been fulfilled? [4]
- 39 1980_01_S2_40 Probability: Dependent Events
The balls which are used to play billiards are divided into two groups; solid-color balls which are numbered from 1 to 8 and striped balls numbered from 9 to 15.
- If a player pockets one ball, what is the probability that it is either a solid-color ball or that it bears an even number? [3]
 - Assume that the player in part *a* is successful in pocketing the striped 10 ball. If he gets another turn, what is the probability that he will pocket another even-numbered striped ball from the remaining group? [3]
 - If a player pockets two balls, what is the probability they will both be solid colors? [4]

40 1980_01_S2_41 Logical Reasoning
 On your answer paper, write the letters a through e . After *each* letter, write a valid conclusion for each set of premises. If no conclusion is possible, write "no conclusion."

- Paul is tall or June is in bloom.
Paul is not tall. [2]
- If Kate goes to the party, then I am not going.
If I need a gift, then I am going to the party. [2]
- If I pass this test, then I will eat my hat.
I will eat my hat. [2]
- Blue is my favorite color or the Yankees are not my favorite baseball team.
The Yankees are not my favorite baseball team. [2]
- If you do not like the Olympics, you will not go to Lake Placid.
You are going to Lake Placid. [2]

41 1980_01_S2_42 Proofs: Triangle
 Given: $\triangle ABC$, \overline{ABD} , \overline{BE} bisects $\angle CBD$, $\overline{BE} \parallel \overline{AC}$.

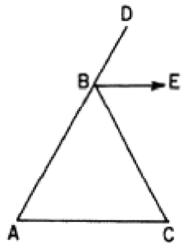

Prove: $\overline{AB} \cong \overline{BC}$ [10]

42 1980_06_S2_01 Triangles: Interior and Exterior Angles of
 In triangle ABC , the measure of angle B is twice the measure of angle A and an exterior angle at vertex C measures 120° . What is the measure of angle A ?

43 1980_06_S2_02 Numbers: Properties of Real
 If $a \odot b$ is a binary operation defined as $\frac{a+b}{a}$, evaluate $2 \odot 4$.

44 1980_06_S2_03 Medians, Altitudes, Bisectors and Midsegments
 The sides of a triangle have lengths of 6, 8, and 10. What is the perimeter of the triangle formed by joining the midpoints of these sides?

45 1980_06_S2_04 Locus
 What is the total number of points that are equidistant from two intersecting lines and are also a distance of 4 centimeters from the point of intersection of the lines?

46 1980_06_S2_05 Triangles: Interior and Exterior Angles of
 The measures of the three angles of a triangle are in the ratio 1:4:5. What is the number of degrees in the measure of the *smallest* angle?

47 1980_06_S2_06 Triangles: Isosceles
 In an isosceles triangle, what is the probability that the altitude and the median drawn to the base are congruent?

48 1980_06_S2_07 Combinatorics: Permutations
 How many different arrangements of 5 letters can be made using the letters in the word "FLOOR"?

49 1980_06_S2_08 Distance
 The coordinates of the vertices of right triangle ABC are $A(0,4)$, $B(0,0)$, and $C(4,0)$. Find the length of hypotenuse AC in radical form.

50 1980_06_S2_09 Midpoint
 The midpoint M of the line segment \overline{AB} has coordinates $(4,9)$. If the coordinates of A are $(2,8)$, what are the coordinates of B ?

51 1980_06_S2_10 Equations: Writing Linear
 Write an equation of the line whose slope is zero and which passes through the point $(-5,7)$.

52 1980_06_S2_11 Quadratics: $a > 1$
 What is the positive root of the equation $2x^2 + 5x - 3 = 0$?

53 1980_06_S2_12 Combinatorics: Combinations
 A committee of 5 is to be chosen from 8 club members. How many different committees can be chosen?

54 1980_06_S2_13 Probability: Theoretical
A signal is made by arranging one red, one white, one blue, and one yellow flag on a vertical pole. What is the probability that the red flag will be on top?

55 1980_06_S2_14 Circles: Equations of
What are the coordinates of the center of the circle whose equation is $(x - 3)^2 - (y - 2)^2 = 12$?

56 1980_06_S2_15 Numbers: Properties of Real
Using the accompanying table, find the inverse element of b .

$\bar{\quad}$	a	b	c	d
a	c	d	a	b
b	d	a	b	c
c	a	b	c	d
d	b	c	d	a

57 1980_06_S2_17 Logical Reasoning: Symbolic Logic
What value(s) of x will make the following statement true?

$$(x^2 = 9) \wedge (x + 2 = 5)$$

58 1980_06_S2_19 Parallel Lines: Angles Involving
In the accompanying diagram, $\angle 1$ and $\angle 2$ are supplementary. Which is *always* true?

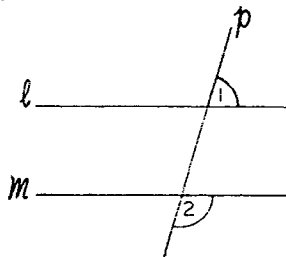

- (1) $l \perp p$
- (2) $l \perp m$
- (3) $l \parallel p$
- (4) $p \parallel m$

59 1980_06_S2_20 Special Quadrilaterals: Rectangles and Squares
A rectangle has a diagonal of length 10 and one side of length 6. What is the perimeter of the rectangle?

- (1) 14
- (2) 21
- (3) 28
- (4) 48

60 1980_06_S2_21 Medians, Altitudes, Bisectors and Midsegments
In equilateral triangle ABC , \overline{AD} and \overline{BE} , the bisectors of angles A and B , respectively, intersect at point F . What is $m\angle AFB$?

- (1) 150
- (2) 120
- (3) 90
- (4) 60

61 1980_06_S2_22 Triangles: Mean Proportionals
The altitude drawn to the hypotenuse of a right triangle divides the hypotenuse into two segments of length 3 and 12. What is the length of this altitude?

- (1) 36
- (2) 18
- (3) 6
- (4) 4

62 1980_06_S2_23 Triangle Inequalities
In isosceles triangle ABC , $\overline{AC} \cong \overline{BC}$ and D is a point lying between A and B on base \overline{AB} . If \overline{CD} is drawn, then which is true?

- (1) $AC > CD$
- (2) $CD > AC$
- (3) $m\angle A > m\angle ADC$
- (4) $m\angle B > m\angle BDC$

63 1980_06_S2_24 Logical Reasoning: Converse
Given the true statements, "If Paul catches fish today, then he will give me some." And "Paul will give me some fish."

Which statement must be true?

- (1) Paul will not give me some fish.
- (2) Paul will not catch some fish today.
- (3) Paul will catch some fish today.
- (4) No conclusion is possible.

- 64 1980_06_S2_25 Graphs: Identifying Equations of
Which is an equation of the parabola shown in the accompanying graph?

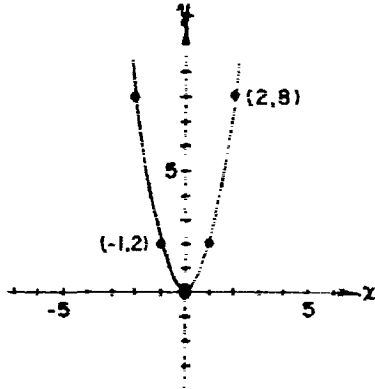

- (1) $y = \frac{1}{2}x^2$
 (2) $y = -\frac{1}{2}x^2$
 (3) $y = 2x^2$
 (4) $y = -2x^2$
- 65 1980_06_S2_26 Locus
An equation which represents the locus of all the points 6 units to the left of the y-axis is
 (1) $x = 6$
 (2) $x = -6$
 (3) $y = 6$
 (4) $y = -6$
- 66 1980_06_S2_27 Numbers: Properties of Real
Under which operation is the set $\{1,3,9,27,81,\dots\}$ closed?
 (1) addition
 (2) subtraction
 (3) multiplication
 (4) division
- 67 1980_06_S2_28 Numbers: Properties of Real
Which is *not* necessary for a system to be a group?
 (1) associative property
 (2) an identity element
 (3) inverse property
 (4) commutative property

- 68 1980_06_S2_29 Triangles: Special Right
In the accompanying figure, altitude \overline{FG} is drawn in triangle DEF . If $DE = 8$, $DG = 4$, and $m\angle E = 60^\circ$, what is the length of \overline{EF} ?

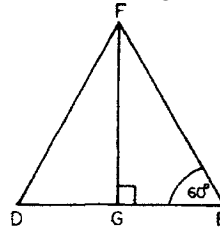

- (1) $\frac{8\sqrt{3}}{3}$
 (2) $8\sqrt{3}$
 (3) 8
 (4) $4\sqrt{3}$
- 69 1980_06_S2_30 Quadratics: Noninteger Solutions
Which equation has $x = \frac{-6 \pm \sqrt{24}}{2}$ as its solution?
 (1) $x^2 - 6x - 3 = 0$
 (2) $x^2 - 6x + 3 = 0$
 (3) $x^2 + 6x - 3 = 0$
 (4) $x^2 + 6x + 3 = 0$
- 70 1980_06_S2_31 Parallel and Perpendicular Lines
Which line is parallel to the line $y = 2x + 4$?
 (1) $y = 2x + 6$
 (2) $y = 4 - 2x$
 (3) $y = 4x - 2$
 (4) $2y = x - 2$
- 71 1980_06_S2_32 Proofs: Coordinate
The vertices of a parallelogram are $(0,0)$, $(3,0)$, $(4,4)$, and $(x,4)$. A value of x may be
 (1) 1
 (2) 2
 (3) 3
 (4) -1

72 1980_06_S2_33 Proofs: Triangle

In the accompanying diagram \overline{AB} and \overline{CD} intersect at E and $\angle A \cong \angle B$.

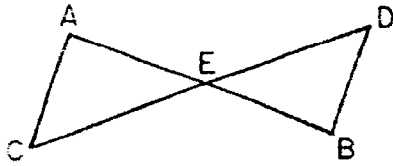

Which additional information is needed to show that $\triangle ACE \cong \triangle DBE$?

- (1) $\overline{AB} \cong \overline{CD}$
- (2) $\overline{AC} \cong \overline{BD}$
- (3) $\overline{AC} \parallel \overline{BD}$
- (4) $\angle C \cong \angle D$

73 1980_06_S2_34 Logical Reasoning

Which is the negation of the statement, "No grass is brown"?

- (1) Some grass is brown.
- (2) Some grass is not brown.
- (3) All grass is brown.
- (4) All grass is not brown.

74 1980_06_S2_35 Constructions

On the answer sheet, construct an equilateral triangle with one vertex at A.

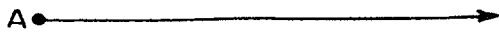

75 1980_06_S2_36 Numbers: Properties of Real

Given the clock 5(mod5) field (F, \div, \bullet) where

$F = \{0, 1, 2, 3, 4\}$ and operations \div and \bullet are defined below:

\div	0	1	2	3	4	\bullet	0	1	2	3	4
0	0	1	2	3	4	0	0	0	0	0	0
1	1	2	3	4	0	1	0	1	2	3	4
2	2	3	4	0	1	2	0	2	4	1	3
3	3	4	0	1	2	3	0	3	1	4	2
4	4	0	1	2	3	4	0	4	3	2	1

- (1) What is the identity element for \bullet ? [2]
- (2) Which element does not have an inverse under the operation \bullet ? [2]
- (3) Find the value of $3 \div 3 \div 3$. [2]
- (4) Find x , if $3x + 4 = 1$. [4]

76 1980_06_S2_37 Proofs: Coordinate

Given: points $A(1,-1)$, $B(5,7)$, $C(0,4)$, and $D(3,k)$.

- a. Find the slope of \overleftrightarrow{AB} . [2]
- b. Express the slope of \overleftrightarrow{CD} in terms of k . [3]
- c. If $\overleftrightarrow{AB} \parallel \overleftrightarrow{CD}$, find k . [2]
- d. Write an equation of \overleftrightarrow{CD} . [3]

77 1980_06_S2_38 Triangles: Mean Proportionals

In right $\triangle ABC$, altitude \overleftrightarrow{CD} is drawn to hypotenuse \overleftrightarrow{AB} , $CD = 12$, and AD exceeds BD by 7.

- a. If $BD = x$, express AD in terms of x . [1]
- b. Write an equation in terms of x , which can be used to find BD . [3]
- c. Find BD . [6]

78 1980_06_S2_39 Quadratics: Graphing

- a. Draw the graph of the equation $y = -x^2 + 2x + 4$, using all integral values of x from $x = -2$ to $x = 4$ inclusive. [6]
- b. Write an equation of the axis of symmetry. [2]
- c. Write an equation of the circle whose center is the origin and which passes through the y -intercept of the graph in part a. [2]

79 1980_06_S2_40 Combinatorics: Combinations

Ann, Ellen, Fred, Jim, and Mark prepare examinations. A committee of three is to be randomly chosen from them to make up a test.

- a. How many 3-person committees can be formed? [2]
- b. What is the probability that Mark will not be chosen for the committee? [3]
- c. How many 3-person committees can be chosen so that Fred and Ann are both members? [3]
- d. What is the probability that Fred and Ann will both be chosen on the same 3-person committee? [2]

80 1980_06_S2_41 Logical Reasoning: Symbolic Logic
 On your answer paper, write the letters a through e .
 Next to each letter, write a true conclusion which
 can be deduced from each set of statements.

- a. If it snows this weekend, we will go skiing.
 We will not go skiing. [2]
- b. Either it rains in April or flowers will not
 grow in May.
 It did not rain in April. [2]
- c. The person who borrowed this book owes
 the library a quarter.
 Mary borrowed this book. [2]

d. $\sim r \rightarrow s$ [2]

$r \rightarrow \sim s$

e. $\sim x \rightarrow y$ [2]

$\sim x$

81 1980_06_S2_42 Proofs: Polygon

Given $ABCD$ is a parallelogram, \overline{BFE} , \overline{CDE} , \overline{AFD} .

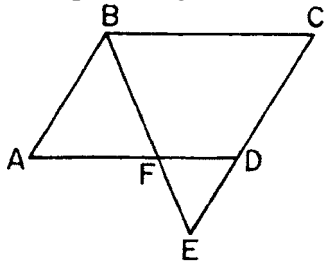

Prove: $AF \times EF = DF \times BF$ [10]

82 1980_06_S2_43 Special Quadrilaterals: Rhombuses
 Quadrilateral $ABCD$ has vertices $A(2,5)$, $B(7,1)$,
 $C(2,-3)$, and $D(-3,1)$. Prove by means of coordinate
 geometry that $ABCD$ is a rhombus. [10]

83 1980_06_S2_44 Logical Reasoning

Given the following statements:

If Carol brings her umbrella, then the weather will
 be sunny.

If Carol goes to the movies, then the weather is not
 sunny.

Either Carol goes to the movies or she plays tennis.
 Carol brought her umbrella.

Let U represent: "Carol brings her umbrella."

Let S represent: "The weather is sunny."

Let M represent: "Carol goes to the movies."

Let T represent: "Carol plays tennis."

a. Using U , S , M , T and proper connectives,
 express each statement in symbolic form. [4]

b. Using laws of inference, show that Carol
 played tennis.

84 1990_01_S2_01 Numbers: Properties of Real

If $a \bullet b$ is a binary operation defined as $(a + b)^2$,
 find $4 \bullet 5$.

85 1990_01_S2_02 Numbers: Properties of Real

Using the accompanying table, solve for x if
 $x \odot H = C$.

\odot	C	A	T	H
C	H	C	A	T
A	C	A	T	H
T	A	T	H	C
H	T	H	C	A

86 1990_01_S2_03 Numbers: Properties of Real

Using the accompanying table, find the inverse of
 the element H .

$*$	M	A	T	H
M	T	H	M	A
A	H	M	A	T
T	M	A	T	H
H	A	T	H	M

- 87 1990_01_S2_04 Parallel Lines: Angles Involving

In the accompanying figure, $\overleftrightarrow{a} \parallel \overleftrightarrow{b}$ and $\overleftrightarrow{c} \parallel \overleftrightarrow{d}$. If $m\angle 1 = 68$, find $m\angle 3$.

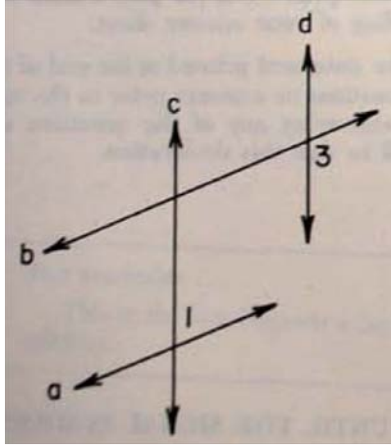

- 88 1990_01_S2_05 Medians, Altitudes, Bisectors and Midsegments

In parallelogram $ABCD$, E is the midpoint of \overline{DC} and F is the midpoint of \overline{AD} . If $FE = 9$, what is the length of diagonal AC ?

- 89 1990_01_S2_06 Combinatorics: Combinations
How many different five-person committees can be selected from nine people?

- 90 1990_01_S2_07 Triangles: Interior and Exterior Angles of
The measures of three angles of a triangle are in the ratio 2:3:4. Find the measure of the largest area of the triangle.

- 91 1990_01_S2_08 Parallel and Perpendicular Lines
Lines l and m are perpendicular. If the slope of line m is $-\frac{4}{3}$, what is the slope of line l ?

- 92 1990_01_S2_09 Midpoint
The coordinates of rhombus $ABCD$ are $A(1,1)$, $B(5,3)$, $C(7,7)$, and $D(3,5)$. Find the coordinates of the point of intersection of the diagonals.

- 93 1990_01_S2_10 Systems: Writing
In a rectangle, the length is twice the width, and the perimeter is 48. Find the area of the rectangle.

- 94 1990_01_S2_11 Triangle Inequalities
In $\triangle ABC$, $m\angle C = 118$ and $m\angle B = 44$. Which is the shortest side of the triangle?

- 95 1990_01_S2_12 Triangles: Isosceles
In the accompanying diagram of $\triangle ABC$, $\overline{AB} \cong \overline{AC}$, $\overline{DB} \cong \overline{DC}$ are angle bisectors, and $m\angle BAC = 20$. Find the measure of $\angle BDC$.

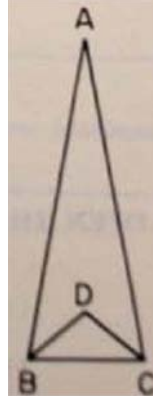

- 96 1990_01_S2_13 Triangles: Interior and Exterior Angles of
In the accompanying diagram of $\triangle ABC$, \overline{BD} is drawn so that $\overline{BD} \cong \overline{DC}$. If $m\angle C = 70$, find $m\angle BDA$.

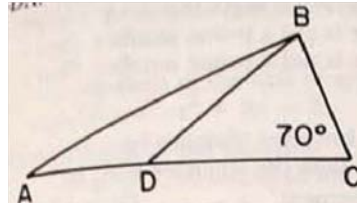

- 97 1990_01_S2_14 Probability: Dependent Events
A bag contains five green marbles and three red marbles. If three marbles are chosen at random and without replacement, what is the probability that all three will be green?

- 98 1990_01_S2_15 Triangles: Mean Proportionals
In the accompanying diagram of $\triangle ABC$, $m\angle ACB = 90$ and CD is an altitude. If $AD = 2$ and $DB = 6$, find AC .

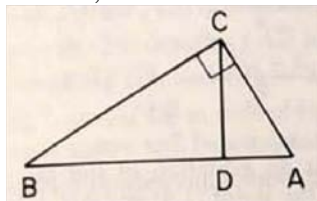

- 99 1990_01_S2_16 Special Quadrilaterals: Rhombuses
The diagonals of a rhombus have lengths of 12 centimeters and 16 centimeters. Find the number of centimeters in the length of one side of the rhombus.
- 100 1990_01_S2_17 Systems: Other Nonlinear
The graphs of the equations $x^2 + y^2 = 9$ and $x = 1$ are drawn on the same set of axes. What is the total number of points common to both graphs?
- 101 1990_01_S2_18 Probability: Theoretical
If a card from a standard deck of 52 cards is drawn, the probability of choosing a face card or ace is
- (1) $\frac{16}{52}$
 - (2) $\frac{12}{52}$
 - (3) $\frac{8}{52}$
 - (4) $\frac{4}{52}$
- 102 1990_01_S2_19 Locus
How many points are equidistant from two intersecting lines and 3 units from their point of intersection?
- (1) 1
 - (2) 2
 - (3) 3
 - (4) 4
- 103 1990_01_S2_21 Quadratics: Find Vertex Given Equation
The coordinates of the turning point of the graph of $y = x^2 + 4x + q$ are $(-2, -7)$. The value of q is
- (1) -1
 - (2) -2
 - (3) -3
 - (4) -17
- 104 1990_01_S2_22 Distance
What is the distance between the points $(-1, 2)$ and $(2, 6)$?
- (1) 5
 - (2) 25
 - (3) $\sqrt{17}$
 - (4) $\sqrt{73}$
- 105 1990_01_S2_23 Special Quadrilaterals: Parallelograms
Which statement is not true for all parallelograms?
- (1) Opposite sides are parallel.
 - (2) Opposite sides are congruent.
 - (3) The diagonals bisect each other.
 - (4) The diagonals are congruent.
- 106 1990_01_S2_24 Combinatorics: Permutations
How many different five-letter permutations can be formed from the letters of the word "DITTO"?
- (1) $5!$
 - (2) $(5 - 2)!$
 - (3) $\frac{5!}{2!}$
 - (4) ${}_5P_2$
- 107 1990_01_S2_25 Logical Reasoning
What is the negation of the statement "Some parallelograms are squares"?
- (1) All parallelograms are not squares.
 - (2) Some squares are parallelograms.
 - (3) Some parallelograms are not squares.
 - (4) All squares are parallelograms.

- 108 1990_01_S2_26 Quadratics: Solving
Given the equation $x^2 - 8x + 15 = 0$. Which statement is true?
 (1) The sum of the roots is 15.
 (2) Both roots are greater than zero.
 (3) One root is less than zero and the other root is greater than zero.
 (4) One root is zero and the other root is greater than zero.
- 109 1990_01_S2_27 Circles: Equations of
An equation of the circle whose center is $(-3,1)$ and whose radius is 8 is
 (1) $(x - 3)^2 + (y + 1)^2 = 64$
 (2) $(x - 3)^2 + (y + 1)^2 = 8$
 (3) $(x + 3)^2 + (y - 1)^2 = 64$
 (4) $(x + 3)^2 + (y - 1)^2 = 8$
- 110 1990_01_S2_28 Combinatorics: Combinations
Which expression is not equivalent to ${}_8C_5$?
 (1) 56
 (2) ${}_8P_5$
 (3) ${}_8C_3$
 (4) $\frac{8 \cdot 7 \cdot 6}{3 \cdot 2 \cdot 1}$
- 111 1990_01_S2_29 Triangle Inequalities
Which set of numbers could represent the lengths of the sides of a triangle?
 (1) {9, 16, 20}
 (2) {8, 11, 19}
 (3) {3, 4, 8}
 (4) {11, 5, 5}
- 112 1990_01_S2_30 Parallel and Perpendicular Lines
Which is an equation of the line that passes through the point $(-1, 5)$ and is parallel to the y-axis?
 (1) $y = -1$
 (2) $y = 5$
 (3) $x = -1$
 (4) $x = 5$
- 113 1990_01_S2_31 Logical Reasoning: Contrapositive
Which statement is logically equivalent to the statement "If $x = 3$, then x is a prime number?"
 (1) If x is a prime number, then $x = 3$.
 (2) If $x \neq 3$, then x is not a prime number.
 (3) If x is not a prime number, then $x \neq 3$.
 (4) If x is not a prime number, then $x = 3$.
- 114 1990_01_S2_32 Similarity
If two isosceles triangles have congruent vertex angles, then the triangles must be
 (1) congruent
 (2) right
 (3) equilateral
 (4) similar
- 115 1990_01_S2_33 Numbers: Properties of Real
Which set is not closed under addition?
 (1) natural numbers
 (2) even integers
 (3) whole numbers
 (4) odd integers
- 116 1990_01_S2_34 Quadratics: Noninteger Solutions
What are the roots of the equation $x^2 - 5x - 2 = 0$?
 (1) $x = \frac{5 \pm \sqrt{17}}{2}$
 (2) $x = \frac{5 \pm \sqrt{33}}{2}$
 (3) $x = \frac{-5 \pm \sqrt{17}}{2}$
 (4) $x = \frac{-5 \pm \sqrt{33}}{2}$
- 117 1990_01_S2_35 Equations: Writing Linear
Which is an equation of the line that passes through the point $(1,4)$ and has a slope of 3?
 (1) $y = 3x + 4$
 (2) $y = \frac{1}{3}x + 4$
 (3) $y = 3x - 1$
 (4) $y = 3x + 1$

- 118 1990_01_S2_36 Quadratics: Graphing
- Write an equation of the axis of symmetry of the graph of $y = -x^2 + 8x - 7$. [2]
 - Draw the graph of the equation $y = -x^2 + 8x - 7$, including all integral values of x such that $0 \leq x \leq 8$. [6]
 - From the graph drawn in part b, find the roots of $-x^2 + 8x - 7 = 0$. [2]

- 119 1990_01_S2_37 Systems: Other Nonlinear
- Solve the following system of equations algebraically and check:
- $$y = 2x^2 + 2x + 3 \quad [8,2]$$
- $$x = y - 3$$

- 120 1990_01_S2_38 Triangles: Mean Proportionals
- In right triangle ABC , CD is the altitude drawn to hypotenuse AB . The length of AD is 2 units less than the length of DB , and $CD = 3$.
- Find the length of DB in radical form. [Only an algebraic solution will be accepted.] [4,4]
 - In this triangle, which statement is true? [2]
 - $CD < DB$
 - $CD = DB$
 - $CD > DB$

- 121 1990_01_S2_39a Proofs: Triangle
- The coordinates of the vertices of $\triangle XYZ$ are $X(1,1)$, $Y(12,-1)$, and $Z(9,5)$. Prove that $\triangle XYZ$ is a right triangle. [5]

- 122 1990_01_S2_39b Area and the Coordinate Plane
- The coordinates of the vertices of $\triangle XYZ$ are $X(1,1)$, $Y(12,-1)$, and $Z(9,5)$. Find the area of $\triangle XYZ$. [5]

- 123 1990_01_S2_40 Locus
- In a given plane, P is a point on line l .
- Describe fully the locus of points in the plane 3 units from line l . [3]
 - Describe fully the locus of points in the plane h units from point P . [3]
 - Using the loci described in parts a and b , what is the number of points of intersection for the following values of h ?
 - $h = 1$ [1]
 - $h = 3$ [1]
 - $h = 3.6$ [2]

- 124 1990_01_S2_41 Proofs: Polygon
- Given: rectangle $ABCD$ with E , the midpoint of \overline{DC} .

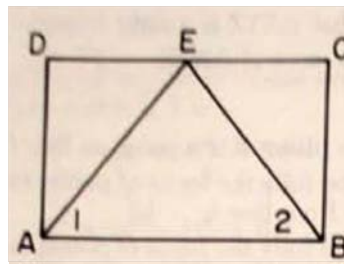

Prove: $\angle 1 \leq \angle 2$ [10]

- 125 1990_01_S2_42 Logical Reasoning
- Given:
- Either the Lakers won the game or the Pistons won the game.
- If Isiah was in the game and Magic was in the game, then Kareem was *not* in the game.
- If the Pistons won the game, then Isiah was in the game.
- Kareem was in the game.
- Magic was in the game.
- Let L represent: "The Lakers won the game."
 Let P represent: "The Pistons won the game."
 Let I represent: "Isiah was in the game."
 Let M represent: "Kareem was in the game."
 Let K represent: "Kareem was in the game."

Prove: The Lakers won the game. [10]

- 126 1990_06_S2_01 Triangles: Interior and Exterior Angles of
 In the accompanying diagram of $\triangle ADB$, $\triangle DCB$,
 $\overline{CD} \cong \overline{CA}$, and $m\angle ACB = 130$. Find $m\angle D$.

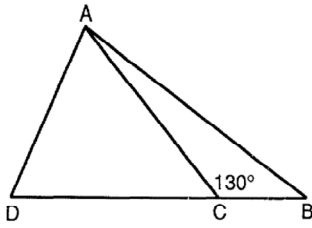

- 127 1990_06_S2_02 Numbers: Properties of Real
 The @ operation for the set $\{T, A, B, L, E\}$ is defined
 in the accompanying chart. What is the identity
 element for @?

@	T	A	B	L	E
T	L	E	T	A	B
A	E	T	A	B	L
B	T	A	B	L	E
L	A	B	L	E	T
E	B	L	E	T	A

- 128 1990_06_S2_03 Similarity
 In the accompanying diagram, \overline{DE} is parallel to
 \overline{AC} . If the ratio of $\overline{AD}:\overline{DB}$ is 2:5 and \overline{CE} measures
 6, find the measure of \overline{EB} .

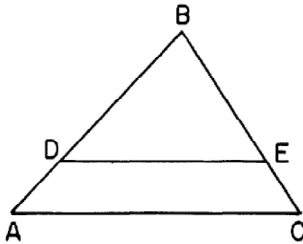

- 129 1990_06_S2_04 Special Quadrilaterals: Parallelograms
 In parallelogram $ABCD$, diagonals \overline{AC} and \overline{BD}
 intersect at E . If $BE = 4x - 12$ and $DE = 2x + 8$,
 find x .

- 130 1990_06_S2_05 Parallel Lines: Angles Involving
 $\longleftrightarrow \longleftrightarrow \longleftrightarrow$
 In the accompanying diagram, \overline{AB} , \overline{CD} , \overline{EF} and
 \overline{GH} are straight lines. If $m\angle w = 30$, $m\angle x = 30$, and
 $m\angle z = 120$, find $m\angle y$.

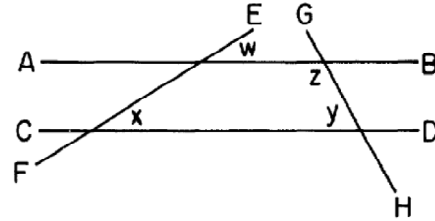

- 131 1990_06_S2_06 Transformations: Reflections
 Find A' , the image of $A(3,5)$, after a reflection in
 the line $y = x$.

- 132 1990_06_S2_07 Trigonometry: Finding Sides
 In right triangle ABC , hypotenuse $AB = 10$ and
 $m\angle B = 53$. Find AC to the nearest integer.

- 133 1990_06_S2_08 Triangles: Interior and Exterior Angles of
 In $\triangle ABC$, an exterior angle at A measures 40° .
 Which is the longest side of the triangle?

- 134 1990_06_S2_09 Complementary, Supplementary and Vertical
 Angles
 In the accompanying diagram, \overline{BCE} , $\overline{AB} \cong \overline{CB}$,
 $\overline{ACD} \perp \overline{DE}$, and $m\angle A = 50$. Find $m\angle E$.

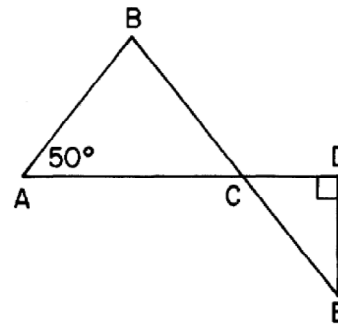

- 135 1990_06_S2_10
 Find the positive root of $x^2 - 2x = 8$.

- 136 1990_06_S2_11 Transformations: Translations
 A translation moves $A(-3,2)$ to $A'(0,0)$. Find B' , the
 image of $B(5,4)$, under the same translation.

137 1990_06_S2_12 Numbers: Properties of Real

If $a * b = a + b^a$, find $2 * 3$.

138 1990_06_S2_13 Medians, Altitudes, Bisectors and Midsegments

If the length of the line segment joining the midpoints of two sides of an equilateral triangle is 6, find the perimeter of the triangle.

139 1990_06_S2_14 Parallel Lines: Angles Involving

In the accompanying diagram of parallelogram $ABCD$, side AD is extended through D to E and DB is a diagonal. If $m\angle EDC = 65$ and $m\angle CBD = 85$, find $m\angle CDB$.

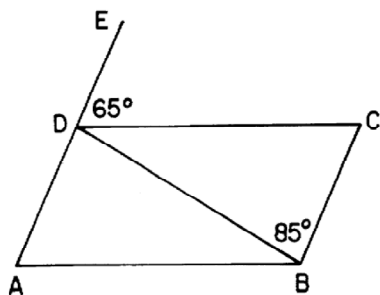

140 1990_06_S2_15 Combinatorics: Combinations

How many three-person committees can be chosen from a group of eight people?

141 1990_06_S2_16 Slope

What is the slope of the line that passes through the points (1,3) and (3,7)?

142 1990_06_S2_17 Equations: Writing Linear

Write an equation of the line that passes through the point (0,3) and whose slope is 2.

143 1990_06_S2_18 Special Quadrilaterals

Given these distinct quadrilaterals: parallelogram, rhombus, rectangle, square, and isosceles trapezoid. What is the probability of choosing at random a quadrilateral whose diagonals are *always* congruent?

144 1990_06_S2_19 Combinatorics: Permutations

How many different arrangements of seven letters can be made using the letters in the name "ULYSSES"?

145 1990_06_S2_20 Logical Reasoning: Symbolic Logic

Given: $p \rightarrow q$

$q \rightarrow r$

What is a logically valid conclusion?

(1) $q \rightarrow \sim r$

(2) $\sim r \rightarrow q$

(3) $r \rightarrow \sim q$

(4) $\sim r \rightarrow \sim q$

146 1990_06_S2_21 Logical Reasoning: Symbolic Logic

The statement $\sim (p \wedge \sim q)$ is logically equivalent to

(1) $\sim p \wedge q$

(2) $p \vee \sim q$

(3) $p \wedge q$

(4) $\sim p \vee q$

147 1990_06_S2_22 Complementary, Supplementary and Vertical Angles

The measures of the acute angles of right triangle ABC are in the ratio 2:3. The measure of the *smaller* acute angle must equal

(1) 18°

(2) 36°

(3) 54°

(4) 90°

148 1990_06_S2_23 Distance

The length of the line segment connecting (2,-2) and (-3,-1) is

(1) $\sqrt{10}$

(2) 2

(3) $\sqrt{26}$

(4) $\sqrt{34}$

149 1990_06_S2_24 Locus

An equation of the locus of points equidistant from the points (0,6) and (0,-2) is

(1) $x = 2$

(2) $x = -2$

(3) $y = 2$

(4) $y = -2$

- 150 1990_06_S2_25 Triangles: Mean Proportionals
 In the accompanying diagram of rectangle $ABCD$, \overline{DE} is perpendicular to diagonal \overline{AC} . If $AE = 3$ and $EC = 9$, what is the length of \overline{AD} ?

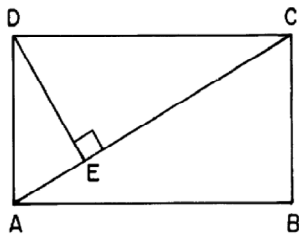

- 151 1990_06_S2_26 Midpoint
 In a circle, diameter \overline{AB} is drawn. The coordinates of A are $(3, -4)$ and the coordinates of the center of the circle are $(1, 1)$. What are the coordinates of B?

- (1) $(-1, 6)$
- (2) $(2, -\frac{3}{2})$
- (3) $(1, -6)$
- (4) $(1, -\frac{5}{2})$

- 152 1990_06_S2_27 Triangles: Pythagoras
 The legs of a right triangle are in the ratio 3:4. If the hypotenuse is 10, what is the length of the longer leg?

- (1) 6
- (2) 8
- (3) 3
- (4) 4

- 153 1990_06_S2_28 Parallel and Perpendicular Lines
 What is the slope of a line that is perpendicular to the line whose equation is $y = 4x + 1$?

- (1) $-\frac{1}{4}$
- (2) $\frac{1}{4}$
- (3) -4
- (4) 4

- 154 1990_06_S2_29 Triangles: Equilateral
 The measure of the altitude of an equilateral triangle whose side has length 6 is

- (1) $\sqrt{3}$
- (2) $2\sqrt{3}$
- (3) $3\sqrt{3}$
- (4) $4\sqrt{3}$

- 155 1990_06_S2_30 Probability: Dependent Events
 An urn contains four red marbles and five blue marbles. What is the probability of selecting at random, without replacement, two blue marbles?

- (1) $\frac{20}{81}$
- (2) $\frac{16}{81}$
- (3) $\frac{20}{72}$
- (4) $\frac{16}{72}$

- 156 1990_06_S2_31 Quadratics: Find Vertex Given Equation
 The coordinates of the turning point of the graph of $y = 2x^2 - 4x + 1$ are

- (1) $(1, -1)$
- (2) $(1, 1)$
- (3) $(-1, 5)$
- (4) $(2, 1)$

- 157 1990_06_S2_32 Numbers: Properties of Real
 Which is an illustration of the associative property?

- (1) $ab = ba$
- (2) $a(b + c) = ab + ac$
- (3) $a(bc) = (ab)c$
- (4) $a + 0 = a$

- 158 1990_06_S2_33 Systems: Quadratic Linear
 If the graphs of $x^2 + y^2 = 4$ and $y = -4$ are drawn on the same axes, what is the total number of points common to both graphs?

- (1) 1
- (2) 2
- (3) 3
- (4) 0

- 159 1990_06_S2_34 Equations: Literal
 If $\frac{a}{x} + 1 = \frac{c}{x}$, which is an expression for x in terms of c and a ?
- (1) $x = c + a$
 - (2) $x = c - a$
 - (3) $x = a - c$
 - (4) $x = a + c + 1$

- 160 1990_06_S2_35 Constructions
 On the answer sheet, construct equilateral triangle ABC using line segment \overline{AB} as one side.

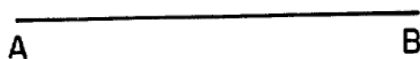

- 161 1990_06_S2_36 Quadratics: Noninteger Solutions
 a. Solve for x and express the answer in radical form.
- $$\frac{1}{x+1} = x - 4 \quad [8]$$
- b. Between which two consecutive integers does the positive root of this equation lie? [2]

- 162 1990_06_S2_37 Special Quadrilaterals: Trapezoids
 In isosceles trapezoid $ABCD$, $m\angle D = 70^\circ$, $AB = 6$, and $DC = 14$.

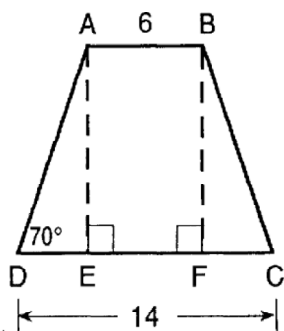

- a. Find DE . [1]
- b. Find altitude AE to the nearest integer. [3]
- c. Using the answer to part b , find the area of trapezoid $ABCD$. [2]
- d. Find AD to the nearest integer. [4]

- 163 1990_06_S2_38 Transformations: Compositions of
 Triangle ABC has coordinates $A(1,2)$, $B(4,2)$, and $C(6,4)$.
- a. On graph paper, draw and label $\triangle ABC$. [1]
 - b. Graph and label $\triangle A'B'C'$, the image of $\triangle ABC$ after a reflection in the x -axis. [3]
 - c. Graph and label $\triangle A''B''C''$, the image of $\triangle ABC$ after a reflection in the origin. [3]
 - d. Graph and label $\triangle A'''B'''C'''$, the image of $\triangle ABC$ after a dilation of constant 2. [3]

- 164 1990_06_S2_39 Quadratics: Inequalities
- a. On graph paper, sketch the graph of the function $y = x^2 - 4x + 2$ over the interval $-1 \leq x \leq 5$. [5]
 - b. On the same set of axes, sketch the graph of the straight line with slope 1 that passes through the y -intercept of $y = x^2 - 4x + 2$. [2]
 - c. Write an equation of the line sketched in part b . [2]
 - d. Write the coordinates of a point inside the closed region formed by the line drawn in part b and the graph of $y = x^2 - 4x + 2$. [1]

- 165 1990_06_S2_40 Logical Reasoning
 Given:
 If I buy a shirt, then I will buy a vest.
 If I do not have money, then I will not buy a vest.
 Either I buy a shirt or I will not go to the dance.
 I am going to the dance.

Let S represent: "I buy a shirt."
 Let V represent: "I buy a vest."
 Let M represent: "I have money."
 Let D represent: "I go to the dance."

Prove: I have money. [10]

- 166 1990_06_S2_41 Proofs: Triangle
 Given: $\triangle ABC$, $\triangle BED$, $\overline{AB} \cong \overline{CB}$, and D is the midpoint of AC .

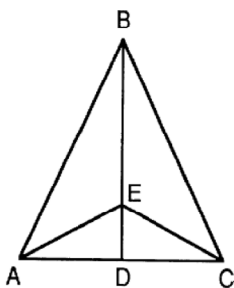

Prove: $\overline{AE} \cong \overline{CE}$ [10]

- 167 1990_06_S2_42 Proofs: Coordinate
 Quadrilateral $ABCD$ has vertices $A(-3,-2)$, $B(9,2)$, $C(1,6)$, and $D(-5,4)$. Using coordinate geometry, prove that quadrilateral $ABCD$ is a trapezoid and contains a right angle. [10]
- 168 1990_08_S2_01 Equations and Expressions: Using Substitution in
 If $c * d$ is defined as $\frac{d^2}{c} - c$, find the value of $4 * 6$.
- 169 1990_08_S2_02 Special Quadrilaterals: Trapezoids
 If the measures of two opposite angles of an isosceles trapezoid are $2x + 20$ and $3x$, what is the value of x ?
- 170 1990_08_S2_03 Transformations: Dilations
 Under a dilation with respect to the origin, the image of $A(1,2)$ is $A'(5,10)$. Under the same dilation, what are the coordinates of B' , the image of $B(0,-3)$?
- 171 1990_08_S2_04 Transformations: Reflections
 What is the image of the point $(-3,2)$ when it is reflected in the x -axis?
- 172 1990_08_S2_05 Triangles: Isosceles
 In isosceles triangle ABC , $AB = 10$ and $BC = 5$. Which is the *smallest* angle of the triangle?

- 173 1990_08_S2_06 Points on a Line: Identification of
 If the point $(k,2)$ is on the line whose equation is $2x + 3y = 4$, what is the value of k ?
- 174 1990_08_S2_07 Medians, Altitudes, Bisectors and Midsegments
 In $\triangle ABC$, what is the probability that the median drawn from vertex A will include the midpoint of side BC ?
- 175 1990_08_S2_08 Parallel Lines: Angles Involving
 In the accompanying diagram of parallelogram $ABCD$, DE is perpendicular to diagonal AC . If $m\angle BAC = 40$ and $m\angle ADE = 70$, find $m\angle B$.

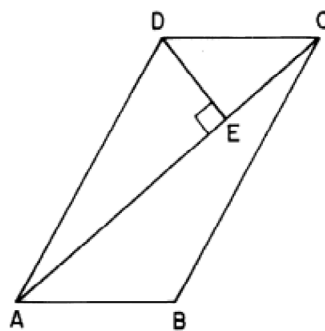

- 176 1990_08_S2_09 Triangles: Interior and Exterior Angles of
 In the accompanying diagram of $\triangle ABC$, side AB is extended to D . If $m\angle ACB = x + 30$, $m\angle CAB = 2x + 10$, and $m\angle CBD = 4x + 30$, what is the value of x ?

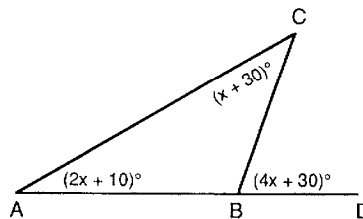

- 177 1990_08_S2_10 Triangles: Isosceles
 In an isosceles triangle, the ratio of the measure of the vertex angle to the measure of a base angle is 1:4. Find the measure of the vertex angle.
- 178 1990_08_S2_11 Trigonometry: Finding Angles
 In a rectangle, the length of the diagonal is 15 and the length of the shorter side is 7. Find, to the *nearest degree*, the number of degrees in the angle formed by the diagonal and the *longer* side of the rectangle.

- 179 1990_08_S2_12 Locus
Point P lies on line m . How many points are both 5 units from line m and 6 units from point P ?
- 180 1990_08_S2_13 Rationals: Solving
Solve for W : $\frac{1}{6} = \frac{1}{w} + \frac{1}{18}$
- 181 1990_08_S2_14 Polygons: Interior and Exterior Angles of
Find the sum of the measures of the interior angles of a hexagon.
- 182 1990_08_S2_15 Equations: Literal
If $L = \frac{1}{2}(P - 2W)$, solve for P in terms of L and W .
- 183 1990_08_S2_16 Logical Reasoning: Symbolic Logic
Which is logically equivalent to $\sim(p \vee \sim q)$?
(1) $\sim p \vee \sim q$
(2) $\sim p \wedge \sim q$
(3) $\sim p \wedge q$
(4) $p \wedge q$
- 184 1990_08_S2_17 Logical Reasoning: Symbolic Logic
If the statement $\left[(p \vee q) \wedge (\sim p) \right]$ is true, which statement must also be true?
(1) $p \wedge q$
(2) p
(3) $\sim q$
(4) q
- 185 1990_08_S2_18 Quadratics: Noninteger Solutions
What is the solution set of the equation $x^2 - 4x - 1 = 0$?
(1) $(2 \pm \sqrt{3})$
(2) $(2 \pm \sqrt{5})$
(3) $(4 \pm \sqrt{12})$
(4) $(4 \pm \sqrt{5})$
- 186 1990_08_S2_19 Similarity
The lengths of the sides of a triangle are 5, 12, and 13. What is the length of the *longest* side of a similar triangle whose perimeter is 90?
(1) 13
(2) 15
(3) 36
(4) 39
- 187 1990_08_S2_20 Parallel and Perpendicular Lines
Which is an equation of the line that is parallel to $y = 3x - 5$ and has the same y -intercept as $y = -2x + 7$?
(1) $y = 3x - 2$
(2) $y = -2x - 5$
(3) $y = 3x + 7$
(4) $y = -2x - 7$
- 188 1990_08_S2_21 Distance
Which point is farthest from the origin?
(1) (0,-5)
(2) (6,0)
(3) (3,4)
(4) (4,2)
- 189 1990_08_S2_22 Systems: Quadratic Linear
Which is a solution for the following system of equations?
 $y = x^2$
 $y = -2x + 15$
(1) (-3,9)
(2) (5,25)
(3) (3,9)
(4) (-5,3)

- 190 1990_08_S2_23 Combinatorics: Permutations
How many different ten-letter permutations can be formed from the letters of the word "CALIFORNIA"?
- (1) $\frac{10!}{2!2!}$
 - (2) $\frac{10!}{2!}$
 - (3) $\frac{10!}{4!}$
 - (4) $\frac{8!}{2!2!}$
- 191 1990_08_S2_24 Midpoint
A circle has center (3,5) and diameter \overline{AB} . The coordinates of A are (-4,6). What are the coordinates of B?
- (1) $\left(-\frac{1}{2}, 4\right)$
 - (2) (10, 4)
 - (3) (10, 1)
 - (4) $\left(-3\frac{1}{2}, 5\frac{1}{2}\right)$
- 192 1990_08_S2_25 Circles: Equations of
Which is an equation of the circle whose center is (3,-2) and whose radius is 7?
- (1) $x^2 + 3 + y^2 - 2 = 49$
 - (2) $x^2 - 3 + y^2 + 2 = 49$
 - (3) $(x + 3)^2 + (y - 2)^2 = 49$
 - (4) $(x - 3)^2 + (y + 2)^2 = 49$
- 193 1990_08_S2_26 Quadratics: Axis of Symmetry
Which is an equation of the axis of symmetry of the graph of $y = x^2 + 6x + 7$?
- (1) $x = -\frac{1}{3}$
 - (2) $x = \frac{1}{3}$
 - (3) $x = -3$
 - (4) $x = 3$
- 194 1990_08_S2_27 Combinatorics: Combinations
In a group of five boys and three girls, how many committees may be formed that consist of two boys and two girls?
- (1) 30
 - (2) 60
 - (3) 70
 - (4) 120
- 195 1990_08_S2_28
If the points (3,2) and (x,-5) lie on a line whose slope is $-\frac{7}{2}$, then x equals
- (1) 5
 - (2) 6
 - (3) $\frac{15}{7}$
 - (4) 4
- 196 1990_08_S2_29 Numbers: Properties of Real
Under which operation are the even integers *not* closed?
- (1) addition
 - (2) subtraction
 - (3) multiplication
 - (4) division
- 197 1990_08_S2_30 Triangles: Mean Proportionals
The altitude to the hypotenuse of a right triangle divides the triangle into two triangles that *must* be
- (1) congruent
 - (2) isosceles
 - (3) equal in area
 - (4) similar
- 198 1990_08_S2_31 Probability: Dependent Events
A bag of marbles contains three blue, one black, and four yellow marbles. If two marbles are chosen at random without replacement, what is the probability that both marbles will be yellow?
- (1) $\frac{3}{14}$
 - (2) $\frac{7}{56}$
 - (3) $\frac{1}{3}$
 - (4) $\frac{1}{4}$

- 199 1990_08_S2_32 Equations: Forming Quadratics from Roots
An equation whose roots are 4 and -1 is

- (1) $x^2 + 3x + 4 = 0$
 (2) $x^2 - 3x - 4 = 0$
 (3) $x^2 - 3x + 4 = 0$
 (4) $x^2 + 3x - 4 = 0$

- 200 1990_08_S2_33 Special Quadrilaterals: Rectangles and Squares
If the perimeter of a square is 8, which is the length of a diagonal?

- (1) $2\sqrt{2}$
 (2) $2\sqrt{3}$
 (3) $8\sqrt{2}$
 (4) 4

- 202 1990_08_S2_35 Constructions

On the answer sheet, construct an angle DEF on line segment \overline{EF} such that $\angle BAC \cong \angle DEF$.

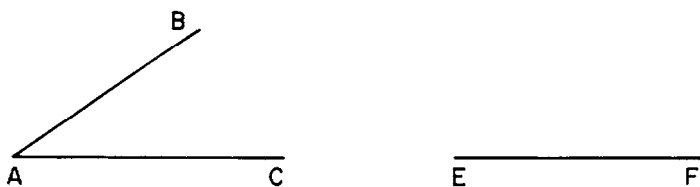

- 203 1990_08_S2_36 Transformations: Compositions of
Given: points $A(2,2)$ and $B(6,3)$.

- a. Find the coordinates of A' , the image of A after a dilation of constant 4 with respect to the origin. [2]
 b. Write the equation of the line $\overleftrightarrow{AA'}$. [2]
 c. Find the coordinates of B' , the image of B after a reflection in line $\overleftrightarrow{AA'}$. [2]
 d. Show that $ABA'B'$ is *not* a parallelogram. [4]

- 201 1990_08_S2_34 Triangles: Isosceles

In $\triangle ABC$, $\overline{AB} \cong \overline{BC}$, $AB = 17$, and $AC = 30$. The length of the altitude to \overline{AC} is

- (1) 17
 (2) 15
 (3) 8
 (4) 4

- 204 1990_08_S2_37 Probability: Geometric

In the accompanying figure of right trapezoid $ABCD$, $AB = 10$, $DC = 18$, $m\angle C = 49^\circ$, and $\overline{BE} \perp \overline{DC}$.

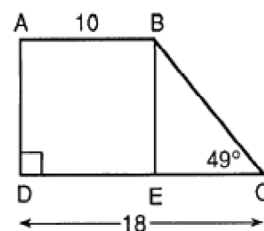

- a. Find BE to the nearest integer. [3]
 b. Find the area of $ABCD$ to the nearest integer. [2]
 c. Find BC to the nearest integer. [3]
 d. If a dart is thrown at random and lands in trapezoid $ABCD$, what is the probability that the dart will also land in rectangle $ABED$? [Use the answers obtained in parts a and b.] [2]

205 1990_08_S2_38a Distance
 The vertices of $\triangle ABC$ $A(-3,1)$, $B(-2,-1)$, and $C(2,1)$.
 Find the lengths of the three sides of $\triangle ABC$. [5]
]

206 1990_08_S2_38b Triangles: Pythagoras
 The vertices of $\triangle ABC$ $A(-3,1)$, $B(-2,-1)$, and $C(2,1)$.
 Show that $\triangle ABC$ is a right triangle. [3]

207 1990_08_S2_38c Area and the Coordinate Plane
 The vertices of $\triangle ABC$ $A(-3,1)$, $B(-2,-1)$, and $C(2,1)$.
 Find the area of $\triangle ABC$. [2]

208 1990_08_S2_39a
 Factor and simplify:
 $\frac{2x+6}{x^2-9} \cdot \frac{x^2-3x}{10}$, $x \neq \pm 3$ [4]

209 1990_08_S2_39b Rationals: Addition and Subtraction of
 Combine:
 $\frac{6}{y} - \frac{5}{2y}$, $y \neq 0$ [2]

210 1990_08_S2_39c Rationals: Solving
 Solve for x : $\frac{2}{3} + \frac{x+7}{x} = 4$, $x \neq 0$ [4]

211 1990_08_S2_40 Systems: Quadratic Linear
 Solve the following system of equations and check:
 $y = x^2 - 4x + 3$ [8,2]
 $y = 2x - 2$

212 1990_08_S2_41 Proofs: Polygon
 Given: quadrilateral $ABCD$, $AFEC$, $\overline{AB} \cong \overline{CD}$,
 $\overline{AD} \cong \overline{CB}$, $DF \perp AC$, and $BE \perp AC$.

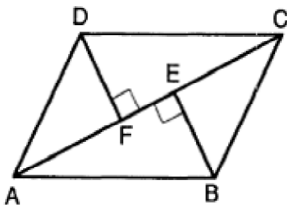

Prove: $\overline{DF} \cong \overline{BE}$

213 1990_08_S2_42 Logical Reasoning
 Given:
 If Kim and Lynette play soccer, then Glenda plays golf.
 If Glenda plays golf, then Helen does not play field hockey.
 Lynette plays soccer.
 Helen plays field hockey.

Let K represent: "Kim plays soccer."
 Let L represent: "Lynette plays soccer."
 Let G represent: "Glenda plays golf."
 Let H represent: "Helen plays field hockey."
 Prove: Kim does not play soccer. [2,8]

S2 - The Sequential Course II Curriculum (2000)

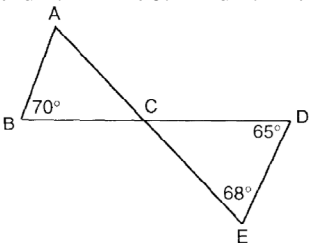
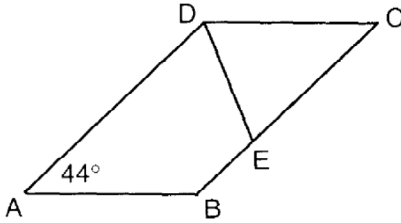
- 214 2000_01_S2_01 Numbers: Properties of Real
If the binary operation \odot is defined by
 $c \odot b = \sqrt{c^2 - b^2}$, what is the value of $25 \odot 24$?
- 215 2000_01_S2_02 Complementary, Supplementary and Vertical Angles
In the accompanying diagram, \overline{BD} and \overline{AE} intersect at C, \overline{AB} and \overline{DE} are drawn, $m\angle D = 65$, $m\angle E = 68$, and $m\angle B = 70$. Find $m\angle A$.
- 
- 216 2000_01_S2_03 Similarity
In similar triangles ABC and DEF , corresponding sides AB and DE equal 15 and 12, respectively. If the perimeter of $\triangle ABC = 40$, what is the perimeter of $\triangle DEF$?
- 217 2000_01_S2_04 Rationals: Solving
Solve for x : $\frac{3x+1}{2} = \frac{7x-4}{4}$
- 218 2000_01_S2_05
Two parallel lines are cut by a transversal. If two interior angles on the same side of the transversal are represented by x° and $(5x - 60)^\circ$, find the value of x .
- 219 2000_01_S2_06 Trigonometry: Law of Sines
In $\triangle ABC$, $m\angle A = 40$, $m\angle B = 70$, and $AC = 5$ centimeters. Find the length of AB in centimeters.
- 220 2000_01_S2_07 Triangle Inequalities
In $\triangle ABC$, the exterior angle at A is acute. Based on this information, which is the longest side of $\triangle ABC$?
- 221 2000_01_S2_08 Combinatorics: Combinations
What is the total number of different 3-person committees that can be formed from a group of 21 students?
- 222 2000_01_S2_09 Polygons: Interior and Exterior Angles of
In the accompanying diagram of parallelogram $ABCD$, \overline{DE} bisects $\angle ADC$ and $m\angle A = 44$. Find $m\angle CDE$.
- 
- 223 2000_01_S2_10 Points on a Line: Identification of
If point $(k, 3k)$ lies on the graph of the equation $3x + y = 12$, what is the value of k ?
- 224 2000_01_S2_11 Triangles: Special Right
The hypotenuse of an isosceles right triangle is $6\sqrt{2}$. Find the length of one leg of the triangle.
- 225 2000_01_S2_12 Transformations: Dilations
What are the coordinates of A' , the image of point $A(-2, 3)$ after a dilation of constant 5 with respect to the origin?

- 226 2000_01_S2_13 Numbers: Properties of Real
The operation \clubsuit for the set $\{C, L, U, B\}$ is defined in the accompanying table. What is the identity element for \clubsuit ?

\clubsuit	C	L	U	B
C	B	U	C	L
L	U	B	L	C
U	C	L	U	B
B	L	C	B	U

- (1) C
(2) L
(3) U
(4) B
- 227 2000_01_S2_14 Graphic Representation of Data
Which diagram could represent the equation $AB + BC - AC = 0$?

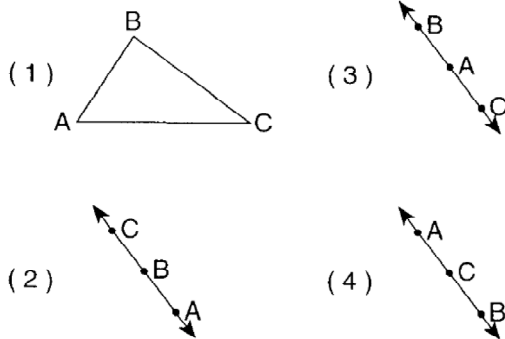

- 228 2000_01_S2_15 Proofs: Triangle
In the accompanying diagram, point T is the midpoint of SD and YU ; SY and UD are drawn.

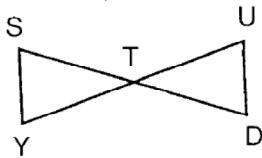

- Which statement can be used to prove $\triangle STY \cong \triangle DTU$?
- (1) $\triangle SSS \cong \triangle SSS$
(2) $\triangle SAS \cong \triangle SAS$
(3) $\triangle ASA \cong \triangle ASA$
(4) $\triangle HL \cong \triangle HL$

- 229 2000_01_S2_16 Logical Reasoning: Symbolic Logic
Which statement is the negation of $p \vee \sim q$?

- (1) $\sim p \vee \sim q$
(2) $p \wedge q$
(3) $\sim p \vee q$
(4) $\sim p \wedge \sim q$

- 230 2000_01_S2_17 Distance
Which point is closest to the origin?

- (1) (3,4)
(2) (-1,6)
(3) (7,0)
(4) (-2,-5)

- 231 2000_01_S2_18 Transformations: Translations
A translation moves point $B(-5,3)$ to point $B'(2,1)$. What is the image of (x,y) under this translation?

- (1) $(x + 7, y - 2)$
(2) $(x + 7, y + 2)$
(3) $(x - 3, y - 2)$
(4) $(x - 3, y + 2)$

- 232 2000_01_S2_19 Triangle Inequalities
Which set of numbers can represent the lengths of the sides of a triangle?

- (1) $\{3,3,6\}$
(2) $\{3,4,7\}$
(3) $\{4,7,10\}$
(4) $\{4,4,9\}$

- 233 2000_01_S2_20 Midpoint
The coordinates of the midpoint of line segment AB are $(2,-5)$. If the coordinates of A are $(6,y)$ and the coordinates of B are $(-2,-3)$, then the value of y is

- (1) 1
(2) -1
(3) -7
(4) -8

234 2000_01_S2_21 Combinatorics: Permutations
 What is the total number of different 11-letter permutations that can be formed from the letters of the word "EQUILATERAL"?

- (1) $11!$
- (2) $\frac{11!}{2!2!2!}$
- (3) $\frac{11!}{5!}$
- (4) $\frac{11!}{6!}$

235 2000_01_S2_22 Quadratics: Noninteger Solutions
 The roots of the equation $x^2 + 7x - 4 = 0$ can be represented as

- (1) $\frac{-7 \pm \sqrt{65}}{2}$
- (2) $\frac{7 \pm \sqrt{65}}{2}$
- (3) $\frac{-7 \pm \sqrt{33}}{2}$
- (4) $\frac{7 \pm \sqrt{33}}{2}$

236 2000_01_S2_23 Slope
 What is the slope of the line containing points (4,-2) and (5,3)?

- (1) $\frac{1}{9}$
- (2) 9
- (3) $\frac{1}{5}$
- (4) 5

237 2000_01_S2_24 Logical Reasoning: Symbolic Logic
 If $a \rightarrow \sim b$, $b \vee c$, and $\sim c$ are all true statements, then which statement must also be true?

- (1) a
- (2) $\sim a$
- (3) $b \rightarrow a$
- (4) $\sim b$

238 2000_01_S2_25 Trigonometric Ratios: Basic
 In the accompanying diagram of right triangle ABC , $\angle B$ is a right angle, $AB = 8$, $BC = 15$, and $CA = 17$.

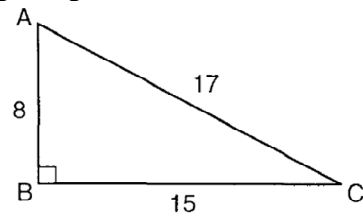

Which ratio is equal to $\frac{8}{17}$?

- (1) $\sin A$
- (2) $\sin C$
- (3) $\cos C$
- (4) $\tan A$

239 2000_01_S2_26 Quadratics: Find Vertex Given Equation
 What are the coordinates of the turning point of the graph of the equation $y = x^2 - 4x + 1$?

- (1) (4,1)
- (2) (-4,33)
- (3) (-2,13)
- (4) (2,-3)

240 2000_01_S2_27 Medians, Altitudes, Bisectors and Midsegments
 Right triangle ABC has a right angle at C , altitude \overline{CD} is drawn, $AC = 10$, and $AB = 20$. What is the length of \overline{AD} ?

- (1) $\sqrt{200}$
- (2) 2
- (3) 40
- (4) 5

241 2000_01_S2_28 Quadratics: Solving
 What is the solution set of the equation $6x - x^2 = 0$?

- (1) $\{0\}$
- (2) $\{0,-6\}$
- (3) $\{0,6\}$
- (4) $\{6\}$

242 2000_01_S2_29 Circles: Equations of
Which equation represents the circle whose center is $(2,-3)$ and whose radius is 7?

(1) $(x-2)^2 + (y+3)^2 = 7$

(2) $(x+2)^2 + (y-3)^2 = 7$

(3) $(x-2)^2 + (y+3)^2 = 49$

(4) $(x+2)^2 + (y-3)^2 = 49$

243 2000_01_S2_30 Equations: Writing Linear
Which equation represents a line that passes through point $(-3,2)$ and is parallel to the line whose equation is $y = -1$?

(1) $y = 2$

(2) $x = 2$

(3) $y = -3$

(4) $x = -3$

244 2000_01_S2_31 Parallel and Perpendicular Lines
Which line is parallel to the line $y - 2x = 4$?

(1) $y = 2x + 6$

(2) $y = -2x + 4$

(3) $y = 4x - 2$

(4) $2y = x + 4$

245 2000_01_S2_32 Polygons: Interior and Exterior Angles of
What is the number of degrees in the measure of each exterior angle of a regular polygon of 18 sides?

(1) 18

(2) 20

(3) 90

(4) 160

246 2000_01_S2_33 Locus
If point p is on line l , what is the total number of points 3 centimeters from point p and 4 centimeters from line l ?

(1) 1

(2) 2

(3) 0

(4) 4

247 2000_01_S2_34 Transformations: Reflections
What are the coordinates of A' , the image of $A(-2,,5)$ under a reflection in the line $y = x$?

(1) $(2,-5)$

(2) $(-5,2)$

(3) $(-2,-5)$

(4) $(5,-2)$

248 2000_01_S2_35 Constructions
On the answer sheet, using point A as the vertex, construct an angle whose measure is 60°



249 2000_01_S2_36 Polynomials: Multiplication and Division of
Answer both a and b for all values of y for which these expressions are defined.

$a.$ Express the product as a single fraction in lowest terms:

$$\frac{y^2 - 4y}{2y^2 - 5y - 3} \cdot \frac{y^2 - 9}{y^2 - y - 12} \quad [5]$$

$b.$ Express the difference as a single fraction in lowest terms:

$$\frac{3y + 1}{y^2 - 1} - \frac{1}{y + 1} \quad [5]$$

250 2000_01_S2_37 Polygons: Area of
In the accompanying diagram of trapezoid $ABCD$, $AB \perp BC$, $BA \perp AD$, and $AC \perp CD$. If $AC = 15$ and $m\angle D = 31$, find the area of trapezoid $ABCD$ to the nearest integer. [10]

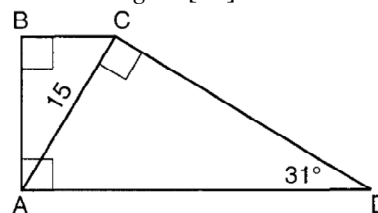

251 2000_01_S2_38 Systems: Other Nonlinear
Solve the following system of equations algebraically or graphically and check.

$$y = x^2 - 8x + 10 \quad [8,2]$$

$$y - x = -8$$

- 252 2000_01_S2_39 Combinatorics: Combinations
 Nine boys and eight girls are members of the drama club. A committee of 5 members is to be selected.
- How many different 5-member committees can be selected? [2]
 - How many of these committees will have two boys and three girls? [2]
 - What is the probability that all boys will be on the committee? [3]
 - What is the probability that four girls and one boy will be on the committee? [3]

- 253 2000_01_S2_40 Area and the Coordinate Plane
 The vertices of a pentagon are $A(-2,-1)$, $B(1,3)$, $C(3,4)$, $D(5,0)$, and $E(3,-2)$. Find the area of pentagon $ABCDE$. [10]

- 254 2000_01_S2_41 Logical Reasoning
 Given:
 If I save money, then I buy a car.
 If I do not save money, then I will take the train.
 If I buy a car and I buy a bike, then I need insurance.
 I do not need insurance.
 I buy a bike.

Let M represent: "I save money."
 Let C represent: "I buy a car."
 Let T represent: "I take the train."
 Let I represent: "I need insurance."
 Let B represent: "I buy a bike."
 Prove: I take the train. [10]

- 255 2000_01_S2_42 Proofs: Triangle
 Triangle CAT has vertices $C(-2,6)$, $A(6,4)$, and $T(0,-2)$, and point $S(3,1)$ is on side AT . Prove that
- $\triangle CAT$ is isosceles [4]
 - \overline{CS} is the perpendicular bisector of AT [6]

- 256 2000_06_S2_01 Numbers: Properties of Real
 The set $\{a,b,c,d\}$ and the operation \odot are shown in the accompanying table. What is the identity element for the operation?

\odot	a	b	c	d
a	d	a	b	c
b	a	b	c	d
c	b	c	d	a
d	c	d	a	b

- 257 2000_06_S2_02 Triangles: Interior and Exterior Angles of
 In the accompanying diagram of isosceles triangle SUM , $SM \cong UM$ and $\angle MUD$ is an exterior angle formed by extending SU to D . If $\angle MUD = 124^\circ$, find $m\angle M$.

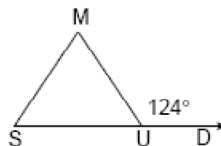

- 258 2000_06_S2_03 Triangle Inequalities
 In $\triangle BIG$, $m\angle B = 53$ and $m\angle G = 66$. Which is the longest side of this triangle?
- 259 2000_06_S2_04 Quadratics: Solving
 Solve for the positive value of x : $\frac{x+4}{2} = \frac{4}{x-3}$
- 260 2000_06_S2_05 Transformations: Translations
 If a translation maps $A(-1,5)$ to $A'(2,9)$, what are the coordinates of B' , the image of $B(2,-2)$ under the same translation?
- 261 2000_06_S2_06 Equations: Forming Quadratics from Roots
 If one of the roots of the equation $x^2 + kx = 28$ is 4, find the value of k .
- 262 2000_06_S2_07 Combinatorics: Combinations
 What is the total number of different four-digit numerals that can be formed using the digits 1, 9, 9, and 9?

263 2000_06_S2_08 Medians, Altitudes, Bisectors and Midsegments

In the accompanying diagram, \overleftrightarrow{ACB} is a straight line, $m\angle DCA = 44$, and \overline{CE} bisects $\angle DCB$. Find $m\angle ECB$.

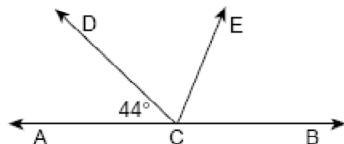

264 2000_06_S2_09 Parallel Lines: Angles Involving

In the accompanying diagram, parallel lines l and m are cut by transversal r , $m\angle 1 = 3x + 40$, and $m\angle 2 = 5x - 20$. Find $m\angle 1$.

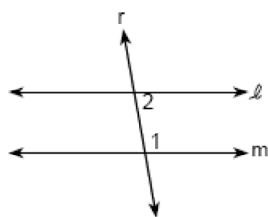

265 2000_06_S2_10 Medians, Altitudes, Bisectors and Midsegments

In the accompanying diagram of $\triangle SRT$, $\overline{LM} \parallel \overline{RT}$. If $SL = 4$, $LR = 3$, and $RT = 21$, find LM .

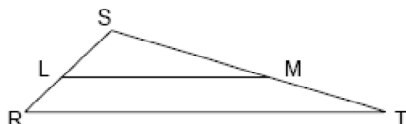

266 2000_06_S2_11 Combinatorics: Combinations

Lake High School has nine mathematics teachers. How many different four-teacher committees can be formed from these nine mathematics teachers?

267 2000_06_S2_12 Distance

Find the distance between points $(14, -4)$ and $(2, 1)$.

268 2000_06_S2_13 Trigonometry: Finding Sides

In the accompanying diagram of right triangle ABC , a right angle is at C , $AB = 26$, and $m\angle A = 27$. Find the length of \overline{BC} to the nearest tenth.

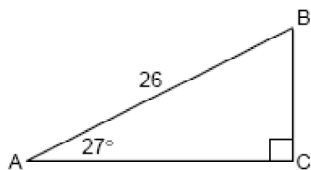

269 2000_06_S2_14 Proofs: Coordinate

The coordinates of three of the vertices of rectangle $RECT$ are $R(-1, 1)$, $E(3, 1)$, and $C(3, 5)$. What are the coordinates of vertex T ?

- (1) $(-5, 3)$
- (2) $(-1, 5)$
- (3) $(1, 3)$
- (4) $(3, -5)$

270 2000_06_S2_15 Logical Reasoning: Symbolic Logic

What is the negation of the statement $m \wedge \sim q$?

- (1) $\sim m \vee q$
- (3) $m \vee \sim q$
- (2) $\sim m \wedge q$
- (4) $m \vee q$

271 2000_06_S2_16 Logical Reasoning: Symbolic Logic

If the statements $a \rightarrow \sim b$, $\sim b \rightarrow c$, and a are true, which statement must also be true?

- (1) b
- (2) $\sim a$
- (3) c
- (4) $\sim c$

272 2000_06_S2_17 Logical Reasoning: Contrapositive

If a conditional statement is true, what must also be true?

- (1) the negation of the statement
- (2) the converse of the statement
- (3) the inverse of the statement
- (4) the contrapositive of the statement

273 2000_06_S2_18 Parallel and Perpendicular Lines

Which statement is true about the lines formed by the graphs of the equations $y = x - 3$ and $x = y - 3$?

- (1) They are identical.
- (2) They intersect but are not perpendicular.
- (3) They are parallel.
- (4) They are perpendicular.

- 274 2000_06_S2_19 Graphs: Identifying Equations of
Which graph represents the equation $y = x^2 - 3$?

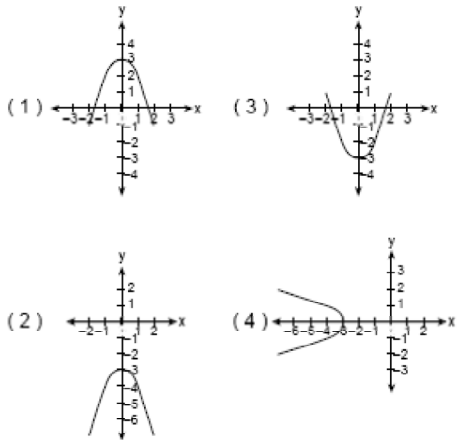

- 275 2000_06_S2_20 Numbers: Properties of Real

If $x \# y = x^y + y^x$, what is the value of $2 \# 5$?

- (1) 20
(2) 35
(3) 42
(4) 57

- 276 2000_06_S2_21 Transformations: Dilations

The image of $P(6, -9)$ after a dilation with respect to the origin is $(4, -6)$. What is the constant of dilation?

- (1) $\frac{1}{3}$
(2) $\frac{2}{3}$
(3) $\frac{3}{2}$
(4) -2

- 277 2000_06_S2_22 Proofs: Triangle

In the accompanying diagram, $\overline{ABC} \cong \overline{EDC}$, \overline{AD} and \overline{BE} are drawn, and $\angle 1 \cong \angle 2$.

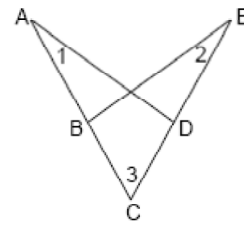

Triangle ADC can be proved congruent to triangle ECB by

- (1) HL \cong HL
(3) ASA \cong ASA
(2) SAS \cong SAS
(4) AAA \cong AAA

- 278 2000_06_S2_23 Polynomials: Addition and Subtraction of

The sum of $\frac{x-6}{3} + \frac{x+2}{x}$ is

- (1) x
(2) $\frac{x-4}{3}$
(3) $\frac{2x-4}{3x}$
(4) $\frac{x^2-3x+6}{3x}$

- 279 2000_06_S2_24 Quadratics: Axis of Symmetry

Which equation represents the axis of symmetry of the graph of the equation $y = x^2 - 4x + 5$

- (1) $x = 2$
(2) $x = -2$
(3) $y = 2$
(4) $y = -2$

- 280 2000_06_S2_25 Polygons: Interior and Exterior Angles of

If each exterior angle of a regular polygon measures 40° , what is the total number of sides in the polygon?

- (1) 5
(2) 6
(3) 8
(4) 9

- 281 2000_06_S2_26 Transformations: Reflections
 What are the coordinates of A' , the image of point $A(4,-2)$ after a reflection in the origin?
 (1) $(-4,2)$
 (2) $(4,2)$
 (3) $(-4,-2)$
 (4) $(-2,4)$

- 282 2000_06_S2_27 Polygons: Area of
 Points $A, B, C,$ and D are midpoints of the sides of square $JETS$.

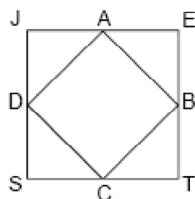

If the area of $JETS$ is 36, the area of $ABCD$ is

- (1) $9\sqrt{2}$
 (2) $18\sqrt{2}$
 (3) 9
 (4) 18
- 283 2000_06_S2_28 Similarity: Right Triangles
 If a tree casts a 90-foot shadow at the same time that a 3-foot pole held perpendicular to the ground casts a 5-foot shadow, what is the height of the tree, expressed in feet?
 (1) 18
 (2) 54
 (3) 72
 (4) 150

- 284 2000_06_S2_29 Triangles: Mean Proportionals
 In the accompanying diagram, $\triangle RST$ is a right triangle, SU is the altitude to hypotenuse RT , $RT = 16$, and $RU = 7$.

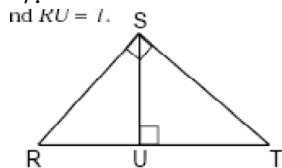

What is the length of ST ?

- (1) $3\sqrt{7}$
 (2) $4\sqrt{7}$
 (3) 9
 (4) 12

- 285 2000_06_S2_30 Midpoint
 The midpoint of AB is M , the coordinates of A are (a,b) , and the coordinates of B are $(a+4,5b)$. What are the coordinates of M ?
 (1) $(2, 2b)$
 (2) $(a+2, 3b)$
 (3) $(2a+4, 6b)$
 (4) $\left(\frac{a+4}{2}, \frac{5b}{2}\right)$

- 286 2000_06_S2_31 Systems: Other Nonlinear
 If the graphs of the equations $x^2 + y^2 = 16$ and $y = 4$ are drawn on the same set of axes, what is the total number of points common to both graphs?
 (1) 1
 (2) 2
 (3) 3
 (4) 0

- 287 2000_06_S2_32 Quadratics: Noninteger Solutions
 The roots of the equation $x^2 - 6x - 2 = 0$ are
 (1) $3 \pm \sqrt{11}$
 (2) $-3 \pm \sqrt{11}$
 (3) $3 \pm \sqrt{7}$
 (4) $-3 \pm \sqrt{7}$

- 288 2000_06_S2_33 Parallel and Perpendicular Lines
 What is the slope of a line that is perpendicular to the line whose equation is $y - 2x = 5$?
 (1) $\frac{1}{2}$
 (2) 2
 (3) $-\frac{1}{2}$
 (4) -2

- 289 2000_06_S2_34 Equations: Writing Linear
 What is an equation of the straight line whose slope is 3 and that passes through point $(-2,0)$?
 (1) $y = 3x - 2$
 (2) $y = 3x + 6$
 (3) $x = 3y - 2$
 (4) $-2x = 3y + 1$

290 2000_06_S2_35 Constructions

On the answer sheet, construct the angle bisector of $\angle ABC$.

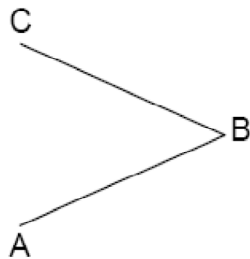

291 2000_06_S2_36 Systems: Other Nonlinear

Solve the following system of equations graphically or algebraically and check.

$$y = x^2 + 2x - 3 \quad [8,2]$$

$$2x + y = -3$$

292 2000_06_S2_37 Proofs: Coordinate

The coordinates of the vertices of $\triangle ABC$ are $A(-4,1)$, $B(4,9)$, and $C(9,-2)$. Point $M(1,6)$ lies on AB .

- Show by means of coordinate geometry that $CM \perp AB$. [4]
- Find, to the nearest degree, the measure of angle A. [6]

293 2000_06_S2_38 Area and the Coordinate Plane

- On graph paper, draw and label the graph of circle A, which is represented by the equation $x^2 + y^2 = 9$. [2]
- On the same set of axes, draw the image of circle A after the translation $(x,y) \rightarrow (x + 5, y - 3)$ and label it B. [3]
- On the same set of axes, draw the image of circle B after a reflection in the x -axis and label it C. [3]
- What is the area of the triangle formed by connecting the centers of the circles drawn in parts a, b, and c? [2]

294 2000_06_S2_39a

For all values of y for which the expressions are defined, express the quotient in simplest form:

$$\frac{2y^2 - 6y}{2y^2 - 7y - 4} \div \frac{y^2 + y - 12}{y^2 - 16} \quad [5]$$

295 2000_06_S2_39b Combinatorics: Combinations

Lorraine won a contest and can select six compact discs (CD's) from a list of 12 CD's. The list contains 5 rock, 3 jazz, and 4 classical CD's. What is the probability that a random selection includes 3 rock, 1 jazz, and 2 classical CD's? [5]

296 2000_06_S2_40 Similarity

In the accompanying diagram, $\triangle ABC \sim \triangle A'B'C'$ and $A'B' = 4$.

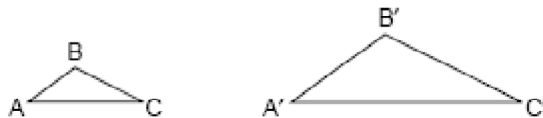

- If AC is 2 more than AB , and $A'C'$ is 6 more than AB , find AB . [Only an algebraic solution will be accepted.] [8]
- Using the results from part a, determine the smallest possible integral value of BC . Justify your answer. [1,1]

297 2000_06_S2_41 Logical Reasoning

Given:

If Mike is the catcher, then Robin plays first base.
 If Uk-Hae is not in the lineup, Mike is the catcher.
 If Edgardo plays second base and Robin plays first base, then Luis is the centerfielder.
 Luis is not the centerfielder.
 Edgardo plays second base.

Let E represent: "Edgardo plays second base."
 Let L represent: "Luis is the centerfielder."
 Let M represent: "Mike is the catcher."
 Let R represent: "Robin plays first base."
 Let U represent: "Uk-Hae is in the lineup."

Prove: Uk-Hae is in the lineup. [10]

- 298 2000_06_S2_42 Proofs: Triangle
 Given: E is the midpoint of \overline{AD} , $\overline{BA} \perp \overline{AD}$, $\overline{CD} \perp \overline{AD}$,
 \overline{BC} , \overline{BE} , and \overline{CE} are drawn, and $\angle 1 \cong \angle 2$.

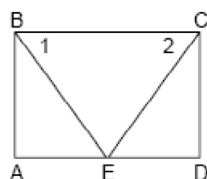

Prove: $\overline{AB} \cong \overline{DC}$ 10]

- 299 2000_08_S2_01 Parallel Lines: Angles Involving
 In the accompanying diagram, line a is parallel to line b and line c is a transversal. If $m\angle 1 = 2x$ and $m\angle 2 = 5x - 54$, what is the value of x ?

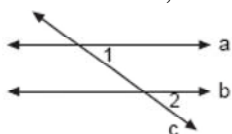

- 300 2000_08_S2_02 Numbers: Properties of Real
 Find the value of $M * (E * T)$ in the system defined below.

*	M	E	T	S
M	T	S	M	E
E	S	M	E	T
T	M	E	T	S
S	E	T	S	M

- 301 2000_08_S2_03 Triangle Inequalities
 In $\triangle REC$, $m\angle E = 55$ and $m\angle R = 65$. Which side of $\triangle REC$ is the *shortest*?

- 302 2000_08_S2_04 Triangles: Interior and Exterior Angles of
 In the accompanying diagram of $\triangle ABC$, \overline{AB} is extended through B to D . If $m\angle CBD = 3x + 20$, $m\angle A = x$, and $m\angle ACB = x + 60$, find x .

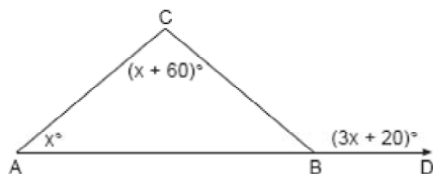

- 303 2000_08_S2_05 Numbers: Properties of Real
 If operation \clubsuit is defined as $a \clubsuit b = \frac{a}{b} + 3$, $b \neq 0$,
 find the value of $3 \clubsuit 6$.

- 304 2000_08_S2_06 Medians, Altitudes, Bisectors and Midsegments
 In $\triangle ABC$, the midpoint of \overline{AC} is R , the midpoint of \overline{CB} is S , and the midpoint of \overline{AB} is T . If $AC = 3$, $CB = 4$, and $AB = 5$, what is the perimeter of $\triangle RST$?

- 305 2000_08_S2_07 Systems: Linear
 Solve this system of equations for the positive value of y .
 $x = 2y$
 $x + y = 8$

- 306 2000_08_S2_08 Similarity
 The lengths of the sides of a triangle are 7, 8, and 10. If the length of the longest side of a similar triangle is 25, what is the length of the *shortest* side of this triangle?

- 307 2000_08_S2_09 Triangles: Mean Proportionals
 In the accompanying diagram, altitude \overline{CD} is drawn to the hypotenuse of right triangle ABC . If $AD = 9$ and $AB = 13$, find CD .

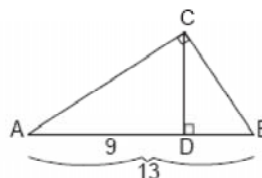

- 308 2000_08_S2_10 Transformations: Dilations
 If a dilation maps $(-3, 2)$ to $(x, 8)$, what is the value of x ?

- 309 2000_08_S2_11 Quadratics: Find Vertex Given Equation
 The coordinates of the turning point of the graph of the equation $y = 2x^2 - 4x + 6$ are $(1, k)$. What is the value of k ?

- 310 2000_08_S2_12 Triangles: Isosceles
 If the number of degrees in a base angle of an isosceles triangle is four times the number of degrees in the vertex angle, what is the number of degrees in a base angle of the triangle?

- 311 2000_08_S2_13 Midpoint
 What is the midpoint of the line segment whose endpoints are $(7, -4)$ and $(-3, -2)$?

- 312 2000_08_S2_14 Logical Reasoning: Symbolic Logic
Which law of logic is represented in this argument?

$$\sim a \rightarrow b$$

$$\sim a$$

$$\therefore b$$

- (1) DeMorgan's Law
(2) Law of Detachment
(3) Law of Disjunctive Inference
(4) Law of Contrapositive
- 313 2000_08_S2_15 Transformations: Reflections
If the point (5,1) is reflected in the y -axis, the image is
- (1) (-5,1)
(2) (-5,-1)
(3) (5,1)
(4) (5,-1)
- 314 2000_08_S2_16 Combinatorics: Permutations
What is the total number of different eight-letter permutations that can be formed from the letters in the word "LOLLIPOP"?
- (1) $\frac{8!}{2!3!}$
(2) $\frac{8!}{7!}$
(3) $\frac{8!}{2!2!3!}$
(4) $8!$
- 315 2000_08_S2_17 Logical Reasoning: Symbolic Logic
Given the conditional statement $p \rightarrow q$, which statement is true?
- (1) The inverse is $p \rightarrow \sim q$.
(2) The converse is $q \rightarrow p$.
(3) The contrapositive is $\sim p \rightarrow \sim q$.
(4) The inverse of the converse is $\sim q \rightarrow \sim p$.
- 316 2000_08_S2_18 Logical Reasoning
Which statement is the negation of "I work or I do not have money"?
- (1) I do not work or I have money.
(2) I do not work and I have money.
(3) I do not work and I do not have money.
(4) I work and I have money.

- 317 2000_08_S2_19 Distance
The distance between coordinates $D(-4,-3)$ and $E(5,9)$ is

- (1) $\sqrt{37}$
(2) $\sqrt{63}$
(3) 12
(4) 15

- 318 2000_08_S2_20 Triangles: Interior and Exterior Angles of
In the accompanying diagram of $\triangle ABC$, C is a point on \overline{AD} , \overline{BC} is drawn, $m\angle A = 65$, $m\angle BCD = 135$, and $m\angle CBD = 20$.

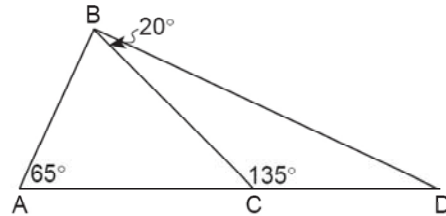

Which statement must be true?

- (1) $\overline{BC} \perp \overline{AD}$
(2) $\overline{AC} \cong \overline{CD}$
(3) $\overline{AB} \cong \overline{BD}$
(4) $\overline{AB} \perp \overline{BD}$
- 319 2000_08_S2_21 Triangle Inequalities
Which set may be the lengths of the sides of an isosceles triangle?
- (1) {1,1,2}
(2) {3,3,8}
(3) {5,12,13}
(4) {4,4,6}
- 320 2000_08_S2_22 Special Quadrilaterals: Parallelograms
Which statement is true about all parallelograms?
- (1) The diagonals are congruent.
(2) The area is the product of two adjacent sides.
(3) The opposite angles are congruent.
(4) The diagonals are perpendicular to each other.

- 321 2000_08_S2_23 Quadratics: Noninteger Solutions
The solution set of $10x^2 - 48x + 32 = 0$ is
- (1) $\{-8, 4\}$
 - (2) $\left\{4, -\frac{1}{5}\right\}$
 - (3) $\left\{4, \frac{4}{5}\right\}$
 - (4) $\left\{-4, \frac{4}{5}\right\}$
- 322 2000_08_S2_24 Rationals: Addition and Subtraction of
The sum of $\frac{2}{x} + \frac{2}{y}$ is
- (1) $\frac{2}{x+y}$
 - (3) $\frac{4}{x+y}$
 - (2) $\frac{4}{xy}$
 - (4) $\frac{2y+2x}{xy}$
- 323 2000_08_S2_25 Combinatorics: Combinations
Which expression is equal to 15?
- (1) ${}_6C_4$
 - (2) ${}_6P_4$
 - (3) ${}_{15}C_{15}$
 - (4) ${}_6P_2$
- 324 2000_08_S2_26 Special Quadrilaterals: Rectangles and Squares
If a side of a square has length 14, the length of a diagonal of the square is
- (1) 14
 - (2) $2\sqrt{14}$
 - (3) $14\sqrt{2}$
 - (4) 28
- 325 2000_08_S2_27 Equations: Graphing
If the slope of a straight line is 0, the graph of this line may pass through Quadrants
- (1) I and II
 - (2) I and III
 - (3) I and IV
 - (4) II and IV
- 326 2000_08_S2_28 Trigonometric Ratios: Basic
In $\triangle ABC$, $m\angle A = 25$ and $m\angle C = 90$. Which ratio represents $\tan 65^\circ$?
- (1) $\frac{AC}{AB}$
 - (2) $\frac{AC}{BC}$
 - (3) $\frac{AB}{AC}$
 - (4) $\frac{BC}{AC}$
- 327 2000_08_S2_29 Circles: Equations of
What is the equation of a circle whose center is $(2, -3)$ and whose radius is 4?
- (1) $(x+2)^2 + (y-3)^2 = 4$
 - (2) $(x-2)^2 + (y+3)^2 = 2$
 - (3) $(x+2)^2 + (y-3)^2 = 16$
 - (4) $(x-2)^2 + (y+3)^2 = 16$
- 328 2000_08_S2_30 Parallel and Perpendicular Lines
Which equation represents a line parallel to the line whose equation is $2y = 3x + 6$?
- (1) $3y = 2x + 6$
 - (2) $2y = -3x + 6$
 - (3) $y = x + 1$
 - (4) $y = x - 4$
- 329 2000_08_S2_31 Locus
Lines l and m are parallel lines 8 centimeters apart, and point P is on line m . What is the total number of points that are equidistant from lines l and m and 5 centimeters from P ?
- (1) 1
 - (2) 2
 - (3) 0
 - (4) 4

- 330 2000_08_S2_32 Special Quadrilaterals: Rhombuses
The perimeter of a rhombus is 60. If the length of its longer diagonal measures 24, the length of the *shorter* diagonal is
- (1) 9
 - (2) 15
 - (3) 18
 - (4) 20
- 331 2000_08_S2_33 Special Quadrilaterals: Trapezoids
The lengths of the bases of an isosceles trapezoid are 6 centimeters and 12 centimeters. If the length of each leg is 5 centimeters, what is the area of the trapezoid?
- (1) 18 cm^2
 - (3) 45 cm^2
 - (2) 36 cm^2
 - (4) 90 cm^2
- 332 2000_08_S2_34 Polygons: Interior and Exterior Angles of
If each interior angle of a regular polygon measures 135° , the polygon must be
- (1) an octagon
 - (2) a decagon
 - (3) a hexagon
 - (4) a pentagon

- 333 2000_08_S2_35 Constructions
On the answer sheet, construct the perpendicular bisector of segment XY .



- 334 2000_08_S2_36 Area and the Coordinate Plane
Find the area of pentagon $CANDY$ with vertices $C(-6,8)$, $A(3,8)$, $N(6,-2)$, $D(-4,-1)$, and $Y(-7,4)$. [10]

- 335 2000_08_S2_37 Rationals: Solving
Answer a , b , and c for all values of x for which these expressions are defined.

a. Simplify: $\frac{4x^2 - 9}{2x^2 - x - 6} \cdot \frac{4x - 8}{2x - 3}$ [4]

b. Express as a single fraction in lowest terms: $\frac{1}{x+2} + \frac{x}{2x+4}$ [3]

c. Solve for x : $\frac{2x}{5} - \frac{x-2}{10} = 2$ [3]

- 336 2000_08_S2_38 Locus
- a. Draw the locus of points 6 units from the origin and label it with its equation. [3]
 - b. Draw the locus of points 6 units from the x -axis and label it with its equations. [3]
 - c. Following the rule $(x, y) \rightarrow (x + 6, y)$, graph the transformation of the locus in part a , and label the graph with its equation. [4]

- 337 2000_08_S2_39a Quadratics: Graphing
Draw and label the graph of the equation $y = 2x^2 - 8x + 1$, including all values of x such that $-1 \leq x \leq 5$. [6]

- 338 2000_08_S2_39b Quadratics: $a > 1$
Using an algebraic method, find the roots of $2x^2 - 8x + 1 = 0$ to the *nearest tenth*. [4]

- 339 2000_08_S2_40 Probability: Independent Events
A jar contains yellow marbles, red marbles, and blue marbles. The number of red marbles is three less than twice the number of blue marbles. The number of yellow marbles is one more than seven times the number of blue marbles. The probability of selecting a yellow marble is $\frac{3}{4}$.

- a. Find the number of marbles of *each* color in the jar. [5]
- b. Three marbles are taken from the jar without replacement.
 - (1) What is the total number of different three marble selections that can be made? [2]
 - (2) What is the probability that the three marbles selected will be one of each color? [3]

340 2000_08_S2_41 Logical Reasoning

Given:

Jim drives a car or Jim takes a bus.

If Jim takes a bus, then Jim carries his bus pass.

Jim does not carry his bus pass.

If Jim drives a car, then Jim buys gasoline.

If Jim buys gasoline, then Jim has a job.

Let C represent: "Jim drives a car."

Let B represent: "Jim takes a bus."

Let P represent: "Jim carries his bus pass."

Let G represent: "Jim buys gasoline."

Let J represent: "Jim has a job."

Prove: Jim has a job. [10]

341 2000_08_S2_42 Proofs: Coordinate

Quadrilateral $QUAD$ has coordinates $Q(-a,0)$, $U(3a,0)$, $A(2a,2a)$, and $D(0,2a)$. Using coordinate geometry, prove that quadrilateral $QUAD$ is an isosceles trapezoid. [10]

S3 - The Sequential Course III Curriculum (1980-1990)

- 1 1980_06_S3_01 Circles: Radian Measure
Express 72° in radian measure.
- 2 1980_06_S3_02 Exponential Functions and Equations
If $f(x) = x^{\frac{2}{3}}$, find $f(-27)$.
- 3 1980_06_S3_03 Circles: Center, Radius and Circumference
In a circle, a central angle of 3 radians intercepts an arc of 18 centimeters. What is the radius, in centimeters, of the circle?
- 4 1980_06_S3_04 Fractions: Complex
Express in simplest form: $\frac{\frac{1}{2} + \frac{1}{x}}{\frac{1}{x}}$
- 5 1980_06_S3_05 Transformations: Reflections
Find the image of (1,5) when it is reflected over the line $y = x$.
- 6 1980_06_S3_06 Summations
Evaluate $\sum_{k=3}^7 (k-2)^2$
- 7 1980_06_S3_07 Trigonometric Graphs
What is the amplitude of the graph of $y = \cos 2x$?
- 8 1980_06_S3_08 Circles: Chords
Chords \overline{AB} and \overline{CD} of circle O intersect at E . If $AE = 4$, $EB = 5$, and $CE = 2$, find ED .
- 9 1980_06_S3_09 Trigonometric Identities: Double and Half Angle
If $\sin x = \frac{3}{5}$, what is the value of $\cos 2x$?
- 10 1980_06_S3_10 Trigonometric Functions: Inverses of
If $\theta = \text{Arc cos} \left(\frac{\sqrt{3}}{2} \right)$, what is the measure of angle θ ?
- 11 1980_06_S3_11 Trigonometric Functions: Inverses of
If $\tan A = 0.4750$, find the value of A to the *nearest minute*.
- 12 1980_06_S3_12 Transformations: Translations
A translation maps $P(4,-3)$ onto $P'(0,0)$. Find the coordinates of Q' , the image of $Q(2,1)$ under the same translation.
- 13 1980_06_S3_13 Trigonometric Identities
If $\tan A = \frac{-5}{12}$ and $\cos A > 0$, find $\sin A$.
- 14 1980_06_S3_14 Trigonometry: Reference Angles
Express $\sin(-170^\circ)$ as a function of a positive acute angle.
- 15 1980_06_S3_15 Rationals: Solving
Solve for x : $\frac{1}{15} + \frac{1}{10} = \frac{1}{x}$
- 16 1980_06_S3_16 Transformations: Rotations
What is the image of the point $(-3,-6)$ on rotation of 90° about the origin?
- 17 1980_06_S3_17 Equations: Logarithmic
If $\log_4 x = 3$, find x .
- 18 1980_06_S3_18 Trigonometric Functions: Evaluating
Find the value of $\cos \frac{5\pi}{3}$.
- 19 1980_06_S3_19 Trigonometry: Law of Sines
In triangle ABC , $\sin A = 0.8$, $\sin B = 0.3$, $a = 24$. Find the length of side b .

20 1980_06_S3_20 Numbers: Complex

The sum of $\sqrt{-2}$ and $\sqrt{-18}$ is

- 1) $6i$
- 2) $2i\sqrt{5}$
- 3) $5i\sqrt{2}$
- 4) $4i\sqrt{2}$

21 1980_06_S3_21 Exponential Functions and Equations

The solution set of $2^{x^2+2x} = 2^{-1}$ is

- 1) $\{1\}$
- 2) $\{-1\}$
- 3) $\{1, -1\}$
- 4) $\{ \}$

22 1980_06_S3_22 Numbers: Complex

The product of $(2 - 2i)$ and $(2 + 2i)$ is

- 1) 0
- 2) 8
- 3) $4 - 4i$
- 4) 4

23 1980_06_S3_23 Logarithms

If $x = \frac{a\sqrt{b}}{c}$, then $\log x$ is equal to

- 1) $\log a + \frac{1}{2} \log b - \log c$
- 2) $\log a + 2 \log b - \log c$
- 3) $\log a - \frac{1}{2} \log b + \log c$
- 4) $\log a - 2 \log b - \log c$

24 1980_06_S3_24 Inequalities: Absolute Value

Which represents the solution set for x in the inequality $|2x - 1| < 7$?

- 1) $\{x | x < -3 \text{ or } x > 4\}$
- 2) $\{x | x < -4 \text{ or } x > 3\}$
- 3) $\{x | -4 < x < 3\}$
- 4) $\{x | -3 < x < 4\}$

25 1980_06_S3_25 Trigonometric Ratios: Cofunction and Reciprocal

If $\sin(A - 30)^\circ = \cos 60^\circ$, the number of degrees in the measure of angle A is

- 1) 30
- 2) 60
- 3) 90
- 4) 120

26 1980_06_S3_26 Symmetry

Which kind of symmetry does a rhombus have?

- 1) line symmetry, only
- 2) point symmetry, only
- 3) both line and point symmetry
- 4) neither line nor point symmetry

27 1980_06_S3_27 Transformations: Reflections

In the accompanying figure, l and m are symmetry lines.

What is $r_l + r_m(\overline{AB})$?

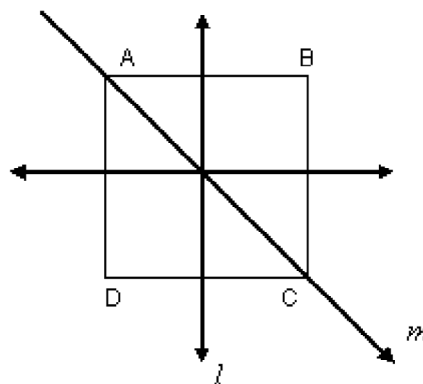

- 1) \overline{AB}
- 2) \overline{BC}
- 3) \overline{CD}
- 4) \overline{DA}

28 1980_06_S3_28 Trigonometric Identities

The expression $(\cot \theta)(\sec \theta)$ is equivalent to

- 1) $(\csc \theta)$
- 2) $(\sin \theta)$
- 3) $(\cos \theta)$
- 4) $(\tan \theta)$

- 29 1980_06_S3_29 Trigonometry: Terminal Sides of Angles
 If $\sin \theta = \frac{1 - \sqrt{17}}{4}$, then angle θ lies in which quadrants?
 1) I and II, only
 2) II and IV, only
 3) II and IV, only
 4) I, II, III, and IV
- 30 1980_06_S3_30 Transformations: Reflections
 A property not preserved under a line reflection is
 1) angle measure
 2) collinearity
 3) distance
 4) orientation
- 31 1980_06_S3_31 Functions: Domain and Range
 What is the domain of the function $f(x) = \sqrt{x-2}$?
 1) $\{x|x \geq 0\}$
 2) $\{x|x \geq 2\}$
 3) $\{x|x \leq 2\}$
 4) $\{x|x \geq -2\}$
- 32 1980_06_S3_32 Central Tendency: Normal Distributions
 If the mean of a test score is 30 and the standard deviation is 3.7, which score could be expected to occur less than 5% of the time?
 1) 35
 2) 33.8
 3) 25
 4) 22
- 33 1980_06_S3_33 Trigonometric Equations
 In the interval $0^\circ \leq \theta \leq 360^\circ$, how many values of θ satisfy the equation $3 \sin^2 \theta + \sin \theta - 2 = 0$?
 1) 1
 2) 2
 3) 3
 4) 4
- 34 1980_06_S3_34 Trigonometry: Law of Cosines
 In triangle ABC , $a = 2$, $b = 3$, and $c = 4$. What is the value of $\cos C$?
 1) $-\frac{1}{16}$
 2) $\frac{1}{16}$
 3) $-\frac{1}{4}$
 4) $\frac{1}{4}$
- 35 1980_06_S3_35 Binomial Expansions
 What is the third term in the expansion of $(a - 3b)^5$?
 1) $90a^3b^2$
 2) $45a^3b^2$
 3) $-45a^3b^2$
 4) $-90a^3b^2$
- 36 1980_06_S3_36a Trigonometric Equations
 Find, to the nearest degree, all values of θ in the interval $0^\circ \leq \theta \leq 360^\circ$ which satisfy the equation $7 \cos \theta + 1 = 6 \sec \theta$. [6]
- 37 1980_06_S3_36b Proofs: Trigonometric
 For all values of θ for which the expressions are defined, prove the identity:
 $\tan \theta + \cot \theta = \sec \theta \csc \theta$ [4]

- 38 1980_06_S3_37a Trigonometric Graphs
On the same set of axes, sketch the graphs of $y = 2 \sin x$ and $y = \cos \frac{1}{2} x$ as x varies from 0 to 2π radians. [8]

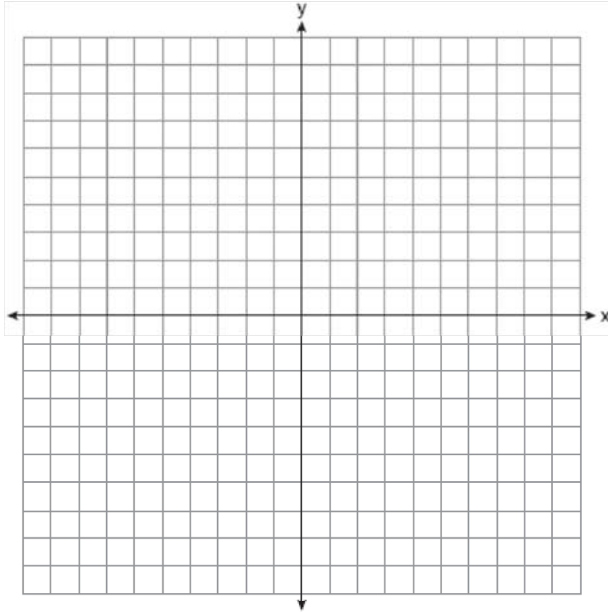

- 39 1980_06_S3_37b Trigonometric Equations
State the number of values of x in the interval $0 \leq x \leq 2\pi$ that satisfy the equation $2 \sin x = \cos \frac{1}{2} x$. [2]

- 40 1980_06_S3_38a Quadratics: Imaginary Solutions
Solve the equation $x^2 - 4x = -13$ and express the roots in the form $a + bi$. [6]

- 41 1980_06_S3_38b Exponential Functions and Equations
Using logarithms, solve the equation $3^{2x} = 4$ for x to the nearest tenth. [4]

- 42 1980_06_S3_39 Trigonometry: Law of Cosines
a. Two consecutive sides of a parallelogram are 8 centimeters and 10 centimeters, respectively. If the length of the longer diagonal of the parallelogram is 14 centimeters, find the measure of the largest angle of the parallelogram to the nearest degree. [7]
b. Using your answer to part a, find the area of the parallelogram to the nearest square centimeter. [3]

- 43 1980_06_S3_40 Central Tendency: Dispersion
The ages of ten teachers at George Washington elementary school are 33, 23, 36, 29, 36, 36, 33, 29, 36, and 29. Determine the standard deviation of these ages to the nearest tenth. [10]

- 44 1980_06_S3_41 Transformations: Compositions of
Given: F is the transformation $(x, y) \rightarrow (-y, -x)$
 U is the transformation $(x, y) \rightarrow (x - 2, y + 4)$
 N is the transformation $(x, y) \rightarrow (2x, 2y)$

The coordinates of $\triangle ABC$ are $A(1,2)$, $B(4,0)$, and $C(3,-2)$.

- Sketch $\triangle ABC$ and its image $\triangle A'B'C'$ after the transformation F . [3]
- Sketch $\triangle A''B''C''$, the image of $\triangle A'B'C'$ after the transformation U . [3]
- Sketch $\triangle A'''B'''C'''$, the image of $\triangle A''B''C''$ after the transformation N . [3]
- Which transformation, F , U , or N , is a dilation? [1]

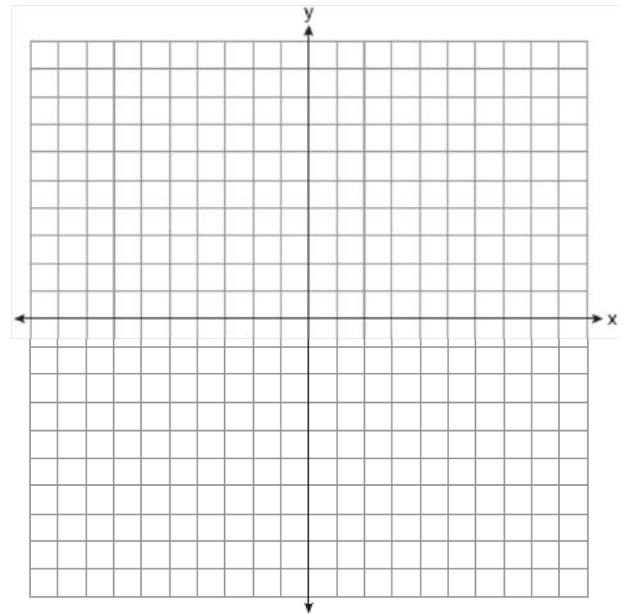

45 1980_06_S3_42 Circles: Chords, Secants and Tangents

In circle O , diameter \overline{AB} is extended to point C . \overline{CD} is tangent to the circle at D . \overline{DE} is a diameter and $m\widehat{BD} : m\widehat{AD} = 1 : 4$.

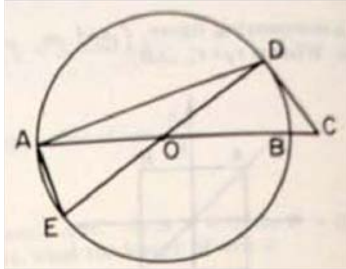

Find:

- $m\widehat{BD}$ [2]
- $m\angle E$ [2]
- $m\angle C$ [2]
- $m\widehat{AE}$ [2]
- $m\angle ADE$ [2]

46 1980_06_S3_43 Probability: Theoretical

The numeric key pad on a calculator is arranged as shown in the diagram below. The probability of pressing any key at random is the same for each key.

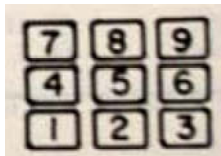

- Find:
 - $P(6)$ [1]
 - $P(\text{even number})$ [1]
 - $P(\text{odd number})$ [1]
- Find the probability of:
 - pressing exactly 2 even numbers on three random presses [2]
 - getting at least 2 even numbers on three random presses [4]

47 1990_01_S3_01 Circles: Radian Measure

Express 240° in radian measure.

48 1990_01_S3_02 Circles: Tangents

In the accompanying diagram, \overline{PAB} and \overline{PCD} are externally tangent to circles O and O' . If $PB = 16$ and $CD = 10$, find PA .

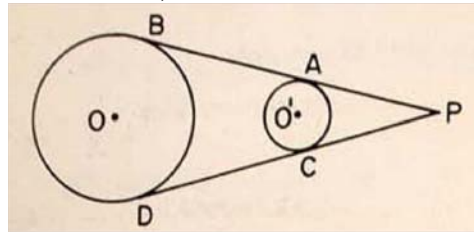

49 1990_01_S3_03 Trigonometric Identities

If x is a positive acute angle and $\cos x = \frac{3}{5}$, find the value of $\sin x$.

50 1990_01_S3_04 Summations

Evaluate: $\sum_{k=1}^3 \frac{6}{k}$

51 1990_01_S3_05 Probability: Binomial with "Exactly"

A fair coin is tossed three times. What is the probability of obtaining exactly three heads?

52 1990_01_S3_06 Trigonometry: Finding Area

Find the area of $\triangle ABC$ if $a = 6$, $b = 12$, and $m\angle C = 150$.

53 1990_01_S3_07 Equations: Absolute Value

Solve for all values of x : $|3x - 1| = 5$

54 1990_01_S3_08 Circles: Chords

In the accompanying diagram, chords \overline{AB} and \overline{CD} of circle O intersect at E . If $AE = x$, $EB = x - 6$, and $CE = ED = 4$, find AE .

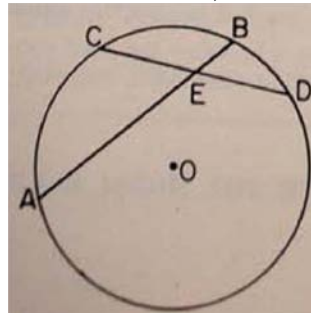

- 55 1990_01_S3_09 Numbers: Complex
Express the sum of $(2 - \sqrt{-4})$ and $(-3 + \sqrt{-16})$ in $a + bi$ form.
- 56 1990_01_S3_10 Exponential Functions and Equations
Find the value of x that satisfies the equation $x^{\frac{3}{2}} = 64$.
- 57 1990_01_S3_11 Radicals: Solving
Solve for x : $3\sqrt{2x+5} - 15 = 0$
- 58 1990_01_S3_12 Trigonometric Equations
If $f(x) = \cos 2x$, find $f\left(\frac{\pi}{2}\right)$.
- 59 1990_01_S3_13 Functions: Domain and Range
A function is defined by the equation $y = 8x - 3$. If the domain is $2 \leq x \leq 4$, find the minimum value in the range of the function.
- 60 1990_01_S3_14 Transformations: Dilations
If $P(4, -3)$ is transformed under the dilation D_{-2} , what is the image of P ?
- 61 1990_01_S3_15 Trigonometry: Law of Sines
In $\triangle ABC$, $m\angle A = 30$, $b = 14$, and $a = 10$. Find $\sin B$.
- 62 1990_01_S3_16 Fractions: Complex
Express in simplest form: $\frac{1 + \frac{2}{x}}{x - \frac{4}{x}}$
- 63 1990_01_S3_17 Transformations: Reflections
Reflecting $(5, 1)$ in the y -axis yields an image of
1) $(5, -1)$
2) $(-5, -1)$
3) $(5, 1)$
4) $(-5, 1)$
- 64 1990_01_S3_18 Central Tendency: Normal Distributions
In a standardized test with a normal distribution of scores, the mean is 63 and the standard deviation is 5. Which score can be expected to occur most often?
1) 45
2) 55
3) 65
4) 74
- 65 1990_01_S3_19 Transformations: Translations
The transformation $T_{(-2, 3)}$ maps the point $(7, 2)$ onto the point whose coordinates are
1) $(9, 5)$
2) $(5, 5)$
3) $(5, -1)$
4) $(-14, 6)$
- 66 1990_01_S3_20 Functional Notation
If $f(x) = |x^3 - 3|$, then $f(-1)$ is equivalent to
1) 0
2) 2
3) -2
4) 4
- 67 1990_01_S3_21 Trigonometric Functions: Inverses of
The value of $\text{Arc sin}\left(\frac{1}{2}\right) + \text{Arc tan}(1)$ is
1) 120°
2) 105°
3) 90°
4) 75°
- 68 1990_01_S3_22 Binomial Expansions
What is the fifth term in the expansion of $(a + bi)^7$?
1) $35a^3b^4$
2) $-35a^3b^4$
3) $21a^2b^5i$
4) $-21a^2b^5i$

- 69 1990_01_S3_23 Circles: Center, Radius and Circumference
In a circle, a central angle containing 1.5 radians intercepts an arc whose measure is 18 centimeters. The length of the radius is
- 1) 6 cm
 - 2) 12 cm
 - 3) 24 cm
 - 4) 27 cm

- 70 1990_01_S3_24 Functions: Inverses of
The inverse function of $\{(2, 6), (-3, 4), (7, -5)\}$ is
- 1) $\{(-2, 6), (3, 4), (-7, -5)\}$
 - 2) $\{(2, -6), (-3, -4), (7, 5)\}$
 - 3) $\{(6, 2), (4, -3), (-5, 7)\}$
 - 4) $\{(-6, -2), (-4, 3), (5, -7)\}$

- 71 1990_01_S3_25 Logarithms
 $\text{Log} \frac{\sqrt{xy}}{z}$ is equal to
- 1) $\frac{1}{2} \log x + \frac{1}{2} \log y - \log z$
 - 2) $\frac{1}{2} \log x + \log y - \log z$
 - 3) $\frac{1}{2} (\log x + \log y - \log z)$
 - 4) $\frac{\frac{1}{2} \log xy}{\log z}$

- 72 1990_01_S3_26 Trigonometric Identities
If $\sin A = k$, then the value of the expression $(\sin A)(\cos A)(\tan A)$ is equivalent to
- 1) 1
 - 2) $\frac{1}{k}$
 - 3) k
 - 4) k^2

- 73 1990_01_S3_27 Trigonometric Functions: Evaluating
What is the value of $\sin(-240^\circ)$?
- 1) $\frac{1}{2}$
 - 2) $-\frac{1}{2}$
 - 3) $\frac{\sqrt{3}}{2}$
 - 4) $-\frac{\sqrt{3}}{2}$

- 74 1990_01_S3_28 Trigonometry: Law of Sines - The Ambiguous Case
How many distinct triangles can be formed if $m\angle A = 30$, $b = 12$ and $a = 6$?
- 1) 1
 - 2) 2
 - 3) 3
 - 4) 0

- 75 1990_01_S3_29 Quadratics: Inequalities
Which graph is the solution set of $x^2 + 3x < 10$?

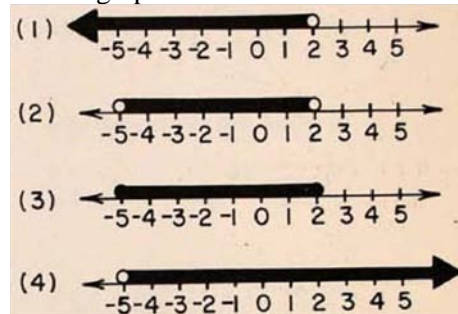

- 76 1990_01_S3_30 Radicals: Rationalizing Denominators
The expression $\frac{7}{3 - \sqrt{2}}$ is equivalent to
- 1) $3 + \sqrt{2}$
 - 2) $3 - \sqrt{2}$
 - 3) $\frac{3 + \sqrt{2}}{7}$
 - 4) $\frac{21 + \sqrt{2}}{7}$

- 77 1990_01_S3_31 Quadratics: Using the Discriminant
For which value of k will the roots of $2k^2 + kx + 1 = 0$ be real?
1) 1
2) 2
3) 3
4) 0
- 78 1990_01_S3_32 Trigonometric Identities: Double and Half Angle
The expression $\frac{\sin 2A}{\sin^2 A}$ is equivalent to
1) 1
2) 2
3) $2 \tan A$
4) $2 \cot A$
- 79 1990_01_S3_33 Trigonometric Graphs
What is the maximum value of y for the equation $y = 1 + 3 \sin x$?
1) 1
2) 2
3) 3
4) 4
- 80 1990_01_S3_34 Trigonometric Graphs
What is the period of the graph of the function $y = \sin 2x$?
1) π
2) 2π
3) 3
4) 4
- 81 1990_01_S3_35 Numbers: Complex
The product of $(3 - 2i)$ and $(7 + 6i)$ is
1) $21 - 12i$
2) $33 + 4i$
3) $9 + 4i$
4) $21 + 16i$
- 82 1990_06_S3_01 Circles: Radian Measure
Express 300° in radian measure.
- 83 1990_06_S3_02 Summations
Evaluate $\sum_{k=2}^5 4k$
- 84 1990_06_S3_03 Numbers: Complex
Express $\sqrt{-8} + \sqrt{-18}$ as a monomial in terms of i .
- 85 1990_06_S3_04 Equations: Logarithmic
If $\log_{(x+1)} 27 = 3$, find the value of x .
- 86 1990_06_S3_05 Equations: Absolute Value
What is the negative root of the equation $|2x + 3| = 1$?
- 87 1990_06_S3_06 Polynomials: Multiplication and Division of
Express the product in simplest form:
$$\left(\frac{a}{a^2 - 25} \right) \left(\frac{a^2 + 2a - 15}{a - 3} \right)$$
- 88 1990_06_S3_07 Exponential Functions and Equations
If $f(x) = x^{-\frac{1}{2}}$, find $f(9)$.
- 89 1990_06_S3_08 Transformations: Translations
A transformation maps (x, y) onto $(y + 1, x - 1)$.
Find the coordinates of B' , the image of $B(2, 1)$ under the same transformation.
- 90 1990_06_S3_09 Functions: Inverses of
Write the inverse of the given function:
 $\{(5, 3), (-2, 4), (7, -2)\}$
- 91 1990_06_S3_10 Fractions: Complex
Simplify: $\frac{\frac{1}{3} + \frac{1}{3x}}{\frac{1}{x} + \frac{1}{3}}$
- 92 1990_06_S3_11 Circles: Tangents
Tangents PA and PB are drawn from point P to the same circle. The major arc intercepted by the tangents is three times the minor arc. Find $m\angle APB$.
- 93 1990_06_S3_12 Exponential Functions and Equations
Solve for x : $27^x = 9^{2x-1}$

94 1990_06_S3_13 Trigonometry: Law of Sines
In $\triangle ABC$, $m\angle A = 30$, $a = 8$, and $b = 12$. Find $\sin B$.

95 1990_06_S3_14 Radicals: Rationalizing Denominators
Write the fraction $\frac{\sqrt{3}}{\sqrt{3}-1}$ with a rational denominator.

96 1990_06_S3_15 Numbers: Complex
Express $(3 - 2i)^2$ in $a + bi$ form.

97 1990_06_S3_16 Trigonometry: Law of Cosines
In $\triangle ABC$, $a = 3$, $b = 8$, and $m\angle C = 60$. Find the length of side c .

98 1990_06_S3_17 Transformations: Dilations
What are the coordinates of the point $(2, -4)$ under the dilation D_{-2} ?

- 1) $(8, -4)$
- 2) $(4, -8)$
- 3) $(-8, 4)$
- 4) $(-4, 8)$

99 1990_06_S3_18 Transformations: Reflections
In the accompanying diagram of circle O , diameter \overline{AB} is perpendicular to chord \overline{CD} at point E . What is the image of \overline{AC} in \overline{AB} ?

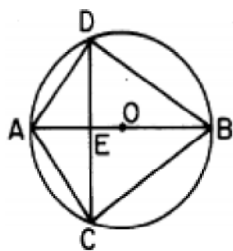

- 1) \overline{AD}
- 2) \overline{BD}
- 3) \overline{ED}
- 4) \overline{AE}

100 1990_06_S3_19 Quadratics: Imaginary Solutions
If $x^2 + y^2 = 9$ and $x = 5$, then a value of y is
1) i
2) 2
3) $4i$
4) 4

101 1990_06_S3_20 Trigonometric Identities: Angle Sum or Difference
If A and B are both acute angles, $\sin A = \frac{5}{13}$ and

$\sin B = \frac{4}{5}$, then $\sin(A - B)$ is

- 1) $-\frac{33}{65}$
- 2) $\frac{63}{65}$
- 3) $\frac{33}{65}$
- 4) $\frac{43}{65}$

102 1990_06_S3_21 Trigonometric Ratios: Cofunction and Reciprocal
Which is equal in value to $\sin 180^\circ$?

- 1) $\tan 45^\circ$
- 2) $\cos 90^\circ$
- 3) $\cos 0^\circ$
- 4) $\tan 90^\circ$

103 1990_06_S3_22 Circles: Chords

In circle O , chords \overline{AB} and \overline{CD} intersect at P . If $AP = a$, $PB = b$, and $CP = c$, what is the length of \overline{PD} ?

- 1) $\frac{ab}{c}$
- 2) $\frac{ac}{b}$
- 3) $\frac{bc}{a}$
- 4) $\frac{a+b}{c}$

104 1990_06_S3_23 Quadratics: Inequalities
 What is the solution set for $x^2 - x - 6 < 0$?

- 1) $\{x|x < -2 \text{ or } x > 3\}$
- 2) $\{x|x < -3 \text{ or } x > 2\}$
- 3) $\{x|-3 < x < 2\}$
- 4) $\{x|-2 < x < 3\}$

105 1990_06_S3_24 Trigonometric Identities: Double and Half Angle

For all values of A for which the expressions are defined, $\frac{\sin 2A}{\cos A} - \sin A$ is equivalent to

- 1) 1
- 2) $\cos A$
- 3) $\sin A$
- 4) $2\sin A$

106 1990_06_S3_25 Trigonometric Graphs

What is the period of $y = \sin 2x$?

- 1) 4π
- 2) 2
- 3) π
- 4) 4

107 1990_06_S3_26 Logarithms

If $\log a = x$ and $\log b = y$, then $\log \sqrt{ab}$ is equivalent to

- 1) $\frac{1}{2}x + y$
- 2) $\frac{1}{2}(x + y)$
- 3) $\frac{1}{2}xy$
- 4) $\frac{1}{4}xy$

108 1990_06_S3_27 Trigonometric Equations

What is the total number of solutions for the equation $3 \tan^2 A + \tan A - 2 = 0$ in the interval $0 \leq A \leq \pi$?

- 1) 1
- 2) 2
- 3) 3
- 4) 4

109 1990_06_S3_28 Trigonometry: Terminal Sides of Angles

If $\sin x = -\frac{1}{3}$ and $\sin x \cos x > 0$, in which quadrant does angle x lie?

- 1) I
- 2) II
- 3) III
- 4) IV

110 1990_06_S3_29. Probability: Binomial with "Exactly"

The fair spinner shown in the diagram below is spun three times. What is the probability of getting a C exactly twice?

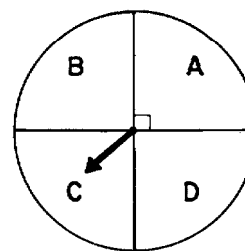

- 1) $\frac{1}{4}$
- 2) $\frac{1}{2}$
- 3) $\frac{27}{64}$
- 4) $\frac{9}{64}$

111 1990_06_S3_30 Central Tendency: Normal Distributions

In the accompanying diagram, the shaded area represents approximately 95% of the scores on a standardized test. If these scores ranged from 78 to 92, which could be the standard deviation?

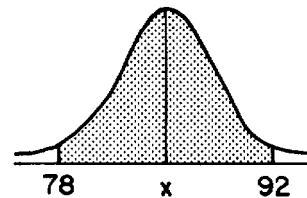

- 1) 3.5
- 2) 7.0
- 3) 14.0
- 4) 20.0

112 1990_06_S3_31 Functions: Domain and Range

For what values of x will the function

$f(x) = \sqrt{x-4}$ be real?

- 1) $\{x|x < 0\}$
- 2) $\{x|x > 0\}$
- 3) $\{x|x \leq 4\}$
- 4) $\{x|x \geq 4\}$

113 1990_06_S3_32 Binomial Expansions

What is the fourth term of the expansion $(a+b)^4$?

- 1) $4a^2b^2$
- 2) $4ab^3$
- 3) $6ab^3$
- 4) $6a^2b^2$

114 1990_06_S3_33 Trigonometric Identities: Angle Sum or Difference

The expression $\tan(180^\circ - y)$ is equivalent to

- 1) -1
- 2) $\frac{-\tan y}{1 + \tan y}$
- 3) $-\tan y$
- 4) $\frac{1 - \tan y}{1 + \tan y}$

115 1990_06_S3_34 Quadratics: Sum and Product of Roots

If the sum of the roots of the equation

$2x^2 - 5x - 3 = 0$ is added to the product of the roots, the result is

- 1) 1
- 2) $-\frac{1}{4}$
- 3) -1
- 4) 4

116 1990_06_S3_35 Trigonometry: Law of Sines - The Ambiguous Case

How many distinct triangles can be constructed if $m\angle A = 30^\circ$, $b = 12$, and $a = 7$?

- 1) 1
- 2) 2
- 3) 3
- 4) 0

117 1990_06_S3_36 Central Tendency: Dispersion

The table below shows the grades for a college statistics class.

Grade (x_i)	Frequency (f_i)
92	2
87	3
82	6
77	9
72	10
67	6
62	4

- a. Find the mean of the data.
- b. Find the standard deviation to the nearest tenth.

118 1990_06_S3_37. Circles: Chords, Secants and Tangents

In the accompanying diagram, \overline{PCD} and \overline{PBA} are secants from external point P to circle O . Chords \overline{DA} , \overline{DEB} , \overline{CEA} , and \overline{CB} are drawn, $m\widehat{AB} = m\widehat{DC}$, $m\widehat{BC}$ is twice $m\widehat{AB}$, and $m\widehat{AD}$ is 60 more than $m\widehat{BC}$.

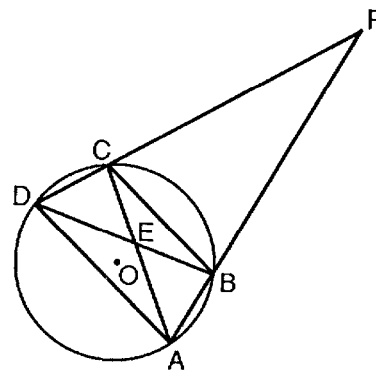

Find: $m\widehat{AB}$, $m\angle P$, $m\angle DAC$, $m\angle DEA$, $m\angle PCB$

119 1990_06_S3_38 Transformations: Compositions of

a Triangle ABC has coordinates $A(0, 9)$, $B(-3, 0)$, and $C(-6, 9)$. On the graph below, draw and label triangle ABC .

b Reflect the graph drawn in part *a* in the origin. State the coordinates of A' , B' , and C' , the images of A , B , and C .

c Dilate the graph drawn in part *b* using $D_{\frac{1}{3}}$.

State the coordinates of A'' , B'' , C'' , the images of A' , B' , and C' .

d Translate the graph drawn in part *c* using $T_{(5,4)}$.

State the coordinates of A''' , B''' , and C''' , the images of A'' , B'' , and C'' .

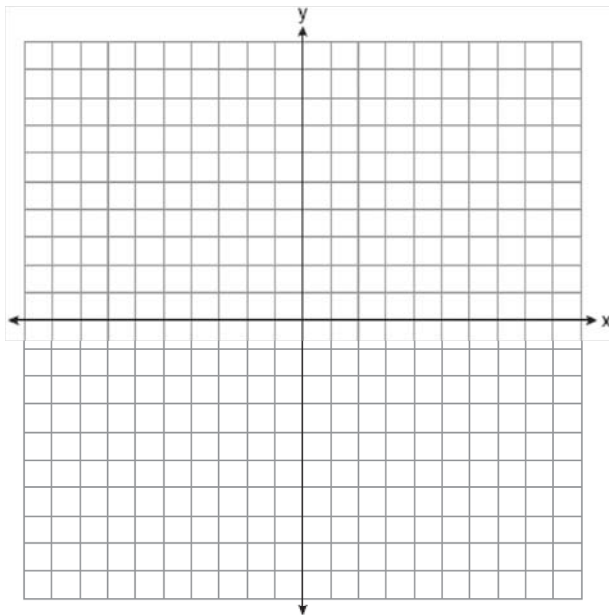

120 1990_06_S3_39a Functions: Inverses of

a. Sketch below the graph of $y = 4^x$.

b. On the same set of axes, sketch the graph of $y = \log_4 x$.

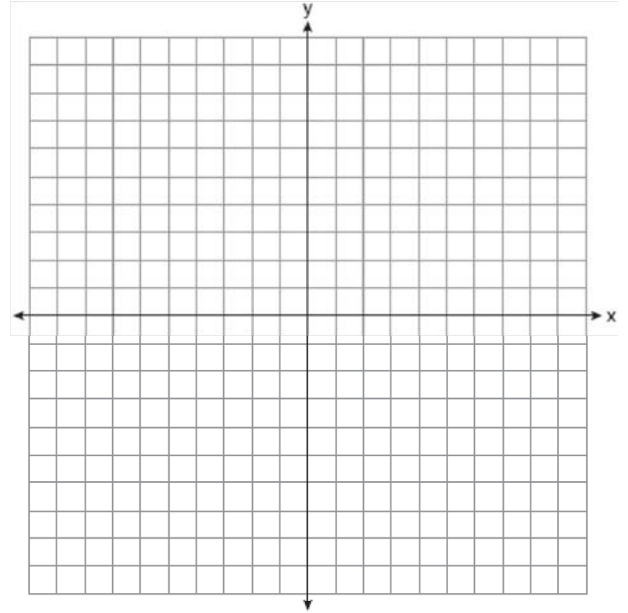

121 1990_06_S3_39c Logarithms

Using logarithms, find $4^{\frac{1}{3}}$ to the nearest tenth. [4]

- 122 1990_06_S3_40a Trigonometric Graphs
Sketch the graph of $y = 3 \sin 2x$ in the interval $-\pi \leq x \leq \pi$.

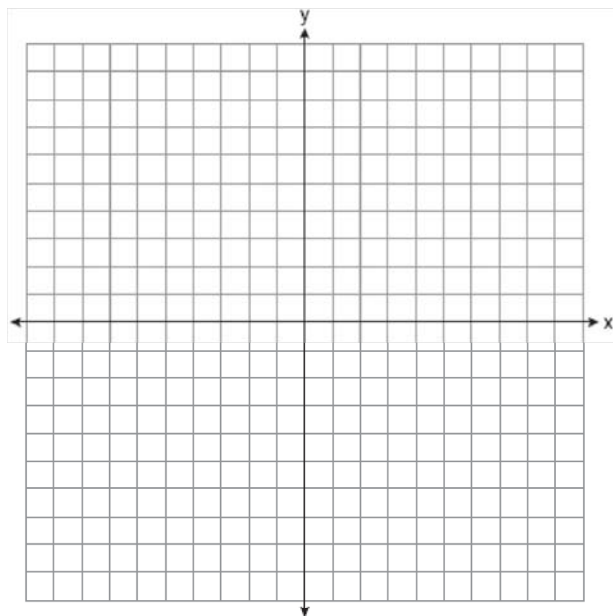

- 123 1990_06_S3_40b Proofs: Trigonometric
For all values of θ for which the expressions are defined, prove the following is an identity:

$$\frac{\cos(90 - \theta)}{\sin 2\theta} = \frac{\sec \theta}{2}$$

- 124 1990_06_S3_41a Quadratics: Imaginary Solutions
Express, in terms of i , the roots of the equation

$$\frac{2}{3}x^2 + 18 = 0 \quad [4]$$

- 125 1990_06_S3_41b Trigonometric Equations
To the *nearest degree*, find all values of x in the interval $0^\circ \leq x \leq 360^\circ$ that satisfy the equation $4 \sin^2 x = 5 \sin x - 1$.

- 126 1990_06_S3_42 Triangles: Vectors
Two forces of 42 pounds and 65 pounds act on a body at an acute angle with each other. The angle between the resultant force and the 42-pound force is 38° . Find, to the *nearest degree*, the angle formed by the 42-pound and the 65-pound forces.
[5,5]

- 127 1990_08_S3_01 Trigonometric Graphs
What is the amplitude of the graph of the equation $y = 3 \sin \frac{1}{2}x$?

- 128 1990_08_S3_02 Circles: Radian Measure
Express 3π radians in degrees.

- 129 1990_08_S3_03 Transformations: Reflections
If $M(-2, 8)$ is reflected in the y -axis, what are the coordinates of M' , the image of M ?

- 130 1990_08_S3_04 Exponential Functions and Equations
If $f(x) = x^{\frac{3}{4}}$, find $f(16)$.

- 131 1990_08_S3_05 Central Tendency
The test scores for five students were 59, 60, 63, 76, and 87. How many points greater than the median is the mean?

- 132 1990_08_S3_06 Equations: Logarithmic
If $\log_x \frac{1}{4} = -1$, find x .

- 133 1990_08_S3_07 Trigonometric Functions: Evaluating
If $\sin \theta = -\frac{4}{5}$ and θ is in Quadrant IV, find $\tan \theta$.

- 134 1990_08_S3_08 Trigonometry: Reference Angles
Express $\sin(-230^\circ)$ as a function of a positive acute angle.

- 135 1990_08_S3_09 Radicals: Rationalizing Denominators
Express $\frac{2}{5 - 2\sqrt{3}}$ as a fraction with a rational denominator.

- 136 1990_08_S3_10 Summations
Evaluate: $\sum_{k=2}^4 (4 - k^2)$

137 1990_08_S3_11 Circles: Chords, Secants and Tangents

In the accompanying diagram, \overline{PA} is tangent to circle O at A and \overline{PBC} is a secant. If $CB = 9$ and $PB = 3$, find the length of PA .

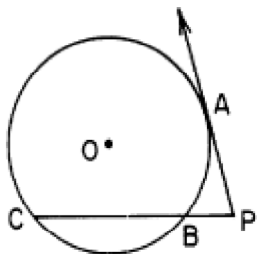

138 1990_08_S3_12 Numbers: Complex

Express $3i(1 - i)$ in $a + bi$ form.

139 1990_08_S3_13 Trigonometry: Law of Sines

In $\triangle ABC$, $a = 5$, $\sin A = \frac{1}{5}$, and $b = 4$. Find $\sin B$.

140 1990_08_S3_14 Exponential Functions and Equations

Solve for x : $3^x = 9^{x-1}$

141 1990_08_S3_15 Transformations: Translations

A translation maps $A(-2, 1)$ onto $A'(2, 2)$. Find the coordinates of B' , the image of $B(-4, -5)$, under the same translation.

142 1990_08_S3_16 Symmetry

Which symbol has two lines of symmetry?

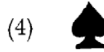

143 1990_08_S3_17 Trigonometric Functions: Evaluating

The value of $(\sin 60^\circ)(\cos 60^\circ)$ is

(1) $\frac{3}{4}$

(2) $\frac{\sqrt{2}}{4}$

(3) $\frac{\sqrt{3}}{3}$

(4) $\frac{\sqrt{3}}{4}$

144 1990_08_S3_18 Numbers: Complex

Expressed in simplest form, $2\sqrt{-50} - 3\sqrt{-8}$ is equivalent to

1) $16i\sqrt{2}$

2) $3i\sqrt{2}$

3) $4i\sqrt{2}$

4) $-\sqrt{-42}$

145 1990_08_S3_19 Trigonometric Identities: Angle Sum or Difference

What is the value of $\sin 210^\circ \cos 30^\circ - \cos 210^\circ \sin 30^\circ$?

1) 1

2) -1

3) 0

4) 180

146 1990_08_S3_20 Circles: Chords

In circle O , diameter \overline{AB} is perpendicular to chord \overline{CD} at E . If $AE = 16$ and $EB = 4$, what is CD ?

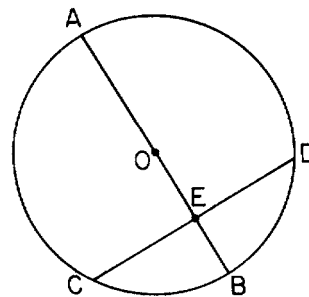

1) 32

2) 16

3) 10

4) 8

- 147 1990_08_S3_21 Transformations: Compositions of
 In the accompanying diagram of a regular octagon, l , m , and p are lines of symmetry. What is $r_p \circ r_m(E)$?

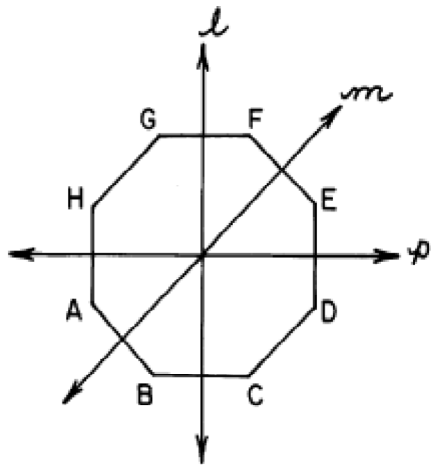

- 1) A
 2) C
 3) G
 4) H
- 148 1990_08_S3_22 Logarithms
 If $A = \pi r^2$, which equation is true?
 1) $\log A = \log \pi + 2 \log r$
 2) $\log A = 2\pi(\log r)$
 3) $\log A = \pi + 2 \log r$
 4) $\log A = \log \pi + \log 2 + \log r$

- 149 1990_08_S3_23 Trigonometric Identities
 The expression $\frac{\sin^2 A}{\tan A}$ is equivalent to
 1) $\frac{\sin A}{\cos A}$
 2) $\sin A \cos A$
 3) $\frac{1}{\sin A \cos A}$
 4) $\frac{\cos A}{\sin A}$

- 150 1990_08_S3_24 Functions: Inverses of
 The inverse of the function $2x + 3y = 6$ is
 1) $y = -\frac{2}{3}x + 2$
 2) $y = -\frac{3}{2}x + 3$
 3) $y = \frac{3}{2}x + 2$
 4) $y = \frac{2}{3}x + 3$

- 151 1990_08_S3_25 Trigonometric Functions: Evaluating
 What is the value of $\tan \frac{\pi}{3} + \cos \pi$?
 1) $\frac{\sqrt{3} + 3}{3}$
 2) $\sqrt{3} - 1$
 3) $\frac{\sqrt{3} - 3}{3}$
 4) $\sqrt{3} + 1$

- 152 1990_08_S3_26 Radicals: Solving
 What is the solution set of the equation
 $\sqrt{9x^2 - 11} = 5$?
 1) $\{0\}$
 2) $\{2\}$
 3) $\{-2\}$
 4) $\{2, -2\}$

- 153 1990_08_S3_27 Fractions: Complex
 The expression $\frac{\frac{4}{x} - 2}{6 - \frac{12}{x}}$ is equal to
 1) -1
 2) $\frac{3}{x}$
 3) $-3x$
 4) $-\frac{1}{3}$

154 1990_08_S3_28 Transformations: Rotations
 What is the image of (1,0) after a counterclockwise rotation of 60° ?

- 1) $\left(\frac{1}{2}, \frac{\sqrt{3}}{2}\right)$
- 2) $\left(\frac{\sqrt{3}}{2}, \frac{1}{2}\right)$
- 3) $\left(\frac{1}{2}, -\frac{\sqrt{3}}{2}\right)$
- 4) $\left(-\frac{\sqrt{3}}{2}, -\frac{1}{2}\right)$

155 1990_08_S3_29 Trigonometric Functions: Properties of
 As θ increases from $\frac{\pi}{2}$ to $\frac{3\pi}{2}$, the value of $\cos \theta$

- 1) decreases, only
- 2) increases, only
- 3) decreases and then increases
- 4) increases and then decreases

156 1990_08_S3_30 Inequalities: Absolute Value
 Which graph represents the solution set of $|5x - 15| < 10$?

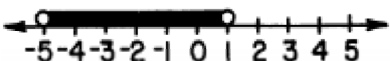
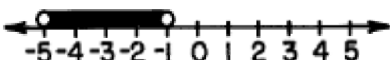
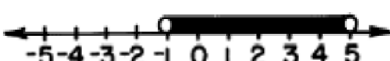
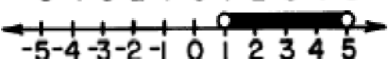
- 1) 
- 2) 
- 3) 
- 4) 

157 1990_08_S3_31 Transformations: Isometries
 Which transformation is *not* an isometry?

- 1) $(x, y) \rightarrow (x + 6, y - 2)$
- 2) $(x, y) \rightarrow (y, -x)$
- 3) $(x, y) \rightarrow \left(\frac{1}{2}x, \frac{1}{2}y\right)$
- 4) $(x, y) \rightarrow (-y, -x)$

158 1990_08_S3_32 Quadratics: Using the Discriminant

The roots of the equation $x^2 + x + 1 = 0$ are

- 1) real, rational, and unequal
- 2) real, irrational, and unequal
- 3) real, rational, and equal
- 4) imaginary

159 1990_08_S3_33 Trigonometry: Law of Sines - The Ambiguous Case

If $m\angle A = 30$, $a = 11$, and $b = 12$, the number of distinct triangles that can be constructed is

- 1) 1
- 2) 2
- 3) 3
- 4) 0

160 1990_08_S3_34 Binomial Expansions

What is the third term in the expansion of $(x - 2y)^5$?

- 1) $40x^3y^2$
- 2) $10x^3y^2$
- 3) $-10x^4y$
- 4) $-80x^2y^3$

161 1990_08_S3_35 Central Tendency: Normal Distributions

The mean of a normally distributed set of data is 52 and the standard deviation is 4. Approximately 95% of all the cases will lie between which measures?

- 1) 44 and 52
- 2) 44 and 60
- 3) 48 and 56
- 4) 52 and 64

162 1990_08_S3_36 Trigonometric Graphs

- a. On the same set of axes, sketch and label the graphs of $y = \sin \frac{1}{2}x$ and $y = 2 \cos x$ as x varies from 0 to 2π radians. [4,4]
- b. Using the same set of axes, sketch the reflection of $y = \sin \frac{1}{2}x$ in the line $y = -1$. [2]

163 1990_08_S3_37a Quadratics: Imaginary Solutions

Express the roots of the equation $3x^2 = -2(2x + 3)$ in $a + bi$ form.

- 164 1990_08_S3_37b Fractions: Complex
Perform the indicated operations and simplify:

$$\frac{x^2 + 4xy + 3y^2}{x^2 - y^2} \cdot \frac{x^2 + xy}{x - y} \div \frac{x^2 + 3xy}{(x - y)^2}$$

- 165 1990_08_S3_38a Trigonometric Equations
Find all values of x in the interval $0^\circ \leq x \leq 360^\circ$ that satisfy the equation $2\sin^2 x = 1 + \sin x$.

- 166 1990_08_S3_38b Proofs: Trigonometric
For all values of x for which the expressions are defined, prove that the following is an identity:

$$\frac{\tan x \csc^2 x}{1 + \tan^2 x} = \cot x$$

- 167 1990_08_S3_39 Circles: Chords, Secants and Tangents
In the accompanying diagram, $\triangle ABC$ is inscribed in circle O . Diameter \overline{BD} is extended through D to point P and intercepts chord \overline{AC} at E , \overrightarrow{PC} is tangent to the circle at C , chord \overline{AD} is drawn, $m\widehat{AD} = 122$, and $m\angle BAC = 73$.

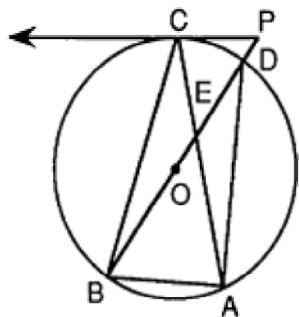

Find: $m\widehat{BC}$, $m\angle ABC$, $m\angle P$, $m\angle BEA$, $m\angle PDA$

- 168 1990_08_S3_40 Trigonometry: Law of Cosines
The sides of a triangular plot of land are 50, 80, and 100 meters.
- Find, to the *nearest degree*, the measure of the largest angle of the triangle.
 - Using the answer obtained in part *a*, find the area of the triangle to the *nearest square meter*.

- 169 1990_08_S3_41a Trigonometric Identities: Angle Sum or Difference
Using the formula for $\cos(x - y)$, find the exact value of $\cos 15^\circ$ in radical form if $m\angle x = 45$ and $m\angle y = 30$.

- 170 1990_08_S3_41b Equations: Logarithmic
Using logarithms, solve for x to the *nearest hundredth*: $x^3 = 7$ [5]

- 171 1990_08_S3_42 Probability: Binomial with "At Least or At Most"
In the accompanying diagram, the circle is divided into four sections as shown, and $m\widehat{AB} : m\widehat{BC} : m\widehat{CD} : m\widehat{DA} = 3 : 4 : 2 : 1$

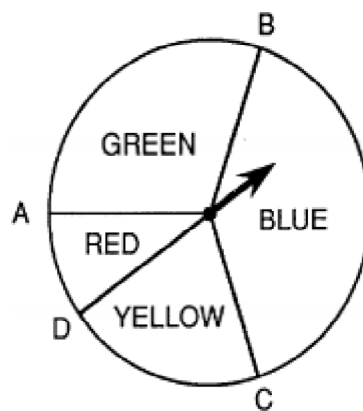

- If the spinner is spun once, find: $P(\text{RED})$; $P(\text{GREEN})$
- Determine the probability of obtaining:
 - exactly two* GREEN's in three spins
 - at least three* RED's in four spins
 - at most two* YELLOW's in three spins

S3 - The Sequential Course III Curriculum (2000)

172 2000_01_S3_01 Circles: Radian Measure

Express $\frac{7\pi}{6}$ radians in degrees.

173 2000_01_S3_02 Numbers: Complex

Express the sum of $3 + \sqrt{-49}$ and $2 + \sqrt{-121}$ in simplest $a + bi$ form.

174 2000_01_S3_03 Equations: Absolute Value

Solve for the positive value of x : $|2x - 3| = 11$

175 2000_01_S3_04 Exponential Functions and Equations

Solve for x : $3^{2x+1} = 27^x$

176 2000_01_S3_05 Functions: Domain and Range

Which negative real number is *not* in the domain of

$$\frac{3}{x^2 - 4}?$$

177 2000_01_S3_06 Summations

Evaluate: $\sum_{n=1}^3 n^2$

178 2000_01_S3_07 Polynomials: Factoring

If $x + 2$ is a factor of $x^2 + bx + 10$, what is the value of b ?

179 2000_01_S3_08 Trigonometry: Finding Area

In $\triangle ABC$, $a = 16$, $c = 14$, and $m\angle B = 30$. What is the area of $\triangle ABC$?

180 2000_01_S3_09 Polygons and Circles: Inscribed

In the accompanying diagram, isosceles triangle ABC is inscribed in circle O with diameter AOB . Find $m\angle CAB$.

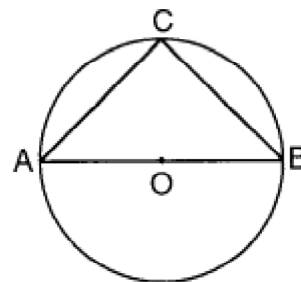

181 2000_01_S3_10 Trigonometry: Law of Sines

In $\triangle ABC$, $a = 2$, $\sin A = \frac{2}{3}$, and $\sin B = \frac{5}{6}$. Find the length of side b .

182 2000_01_S3_11 Trigonometric Functions: Evaluating

If $f(x) = 2\cos^2 x + \sin x - 1$, find the value of $f\left(\frac{\pi}{2}\right)$.

183 2000_01_S3_12 Fractions: Complex

Express $\frac{\frac{x}{3} - 1}{\frac{x^2}{3} - 3}$ in simplest form.

184 2000_01_S3_13 Exponents

Find the value of $5x^0 + x^{-\frac{1}{2}} - x^{\frac{1}{2}}$ when $x = 16$.

185 2000_01_S3_14 Trigonometric Identities: Double and Half Angle

Express $\frac{\cos 2A + \sin^2 A}{\cos A}$ as a single trigonometric function for all values of A for which the fraction is defined.

186 2000_01_S3_15 Chords

In circle O , chords \overline{AB} and \overline{CD} intersect at E , $AE = 3$ inches, $BE = 8$ inches, and CE is 2 inches longer than DE . What is the length of DE , expressed in inches?

187 2000_01_S3_16 Probability: Binomial with "Exactly"
What is the probability of getting *exactly* two heads in three tosses of a fair coin?

188 2000_01_S3_17 Trigonometric Functions: Evaluating

The numerical value of $\sin \frac{3\pi}{2} + \cos \frac{\pi}{4}$ is

- 1) $1 + \frac{\sqrt{2}}{2}$
- 2) $\frac{\sqrt{2}}{2}$
- 3) $-1 + \frac{\sqrt{2}}{2}$
- 4) -1

189 2000_01_S3_18_S3 Trigonometric Identities: Angle Sum or Difference

If $\tan A = \frac{2}{3}$ and $\tan B = \frac{1}{2}$, what is the value of $\tan(A + B)$?

- 1) $\frac{1}{8}$
- 2) $\frac{7}{8}$
- 3) $\frac{1}{4}$
- 4) $\frac{7}{4}$

190 2000_01_S3_19 Trigonometric Graphs

Which trigonometric function is shown in the graph below?

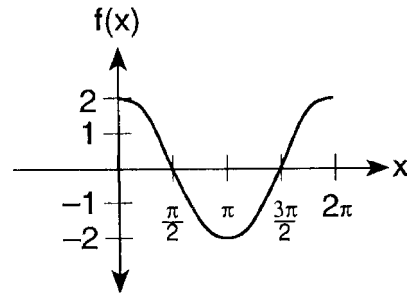

- 1) $f(x) = 2 \sin x$
- 2) $f(x) = 2 \cos x$
- 3) $f(x) = \cos 2x$
- 4) $f(x) = \sin 2x$

191 2000_01_S3_20 Radicals: Solving

What is the solution set of the equation

$$\sqrt{x^2 - 3x + 3} = 1?$$

- 1) $\{1\}$
- 2) $\{2\}$
- 3) $\{1, 2\}$
- 4) $\{ \}$

192 2000_01_S3_21 Trigonometric Functions: Evaluating

If $\sin \theta = -\frac{3}{5}$ and $\cos \theta > 0$, what is the value of $\tan \theta$?

- 1) $\frac{3}{4}$
- 2) $-\frac{3}{4}$
- 3) $\frac{4}{3}$
- 4) $-\frac{4}{3}$

193 2000_01_S3_22 Quadratics: Using the Discriminant

The roots of the equation $x^2 - 7x + 15 = 0$ are

- 1) imaginary
- 2) real, rational, and equal
- 3) real, rational, and unequal
- 4) real, irrational, and unequal

194 2000_01_S3_23 Trigonometry: Law of Sines - The Ambiguous Case

How many distinct triangles can be formed if $a = 20$, $b = 30$, and $m\angle A = 30^\circ$?

- 1) 1
- 2) 2
- 3) 3
- 4) 0

195 2000_01_S3_24 Transformations: Isometries
Which expression is *not* an isometry?

- 1) $r_{y=x}$
- 2) $T_{-2,4}$
- 3) D_{-2}
- 4) $R_{0,90^\circ}$

196 2000_01_S3_25 Trigonometric Equations
What is one solution of the equation $(\sin x + \cos x)^2 = 2$?

- 1) $\frac{\pi}{4}$
- 2) $\frac{\pi}{3}$
- 3) $\frac{\pi}{2}$
- 4) 0

197 2000_01_S3_26 Functions: Defining
Which equation does *not* represent a function?

- 1) $y = 2x$
- 2) $y = x^2 + 10$
- 3) $y = \frac{10}{x}$
- 4) $x^2 + y^2 = 9$

198 2000_01_S3_27 Numbers: Complex

In which quadrant does the sum of $2 + 3i$ and $3 - 5i$ lie?

- 1) I
- 2) III
- 3) II
- 4) IV

199 2000_01_S3_28 Transformations: Compositions of
If the coordinates of point P are $(2, -3)$, then $(R_{90} \circ R_{180})(P)$ is

- 1) $(-2, 3)$
- 2) $(-2, -3)$
- 3) $(3, -2)$
- 4) $(-3, -2)$

200 2000_01_S3_29 Trigonometric Functions: Inverses of
What is the value of $\sin\left(\text{Arccos}\frac{1}{x}\right)$?

- 1) $\frac{\sqrt{1-x^2}}{x}$
- 2) $\frac{\sqrt{1+x^2}}{x}$
- 3) $\frac{\sqrt{x^2-1}}{x}$
- 4) $\frac{x}{\sqrt{x^2+1}}$

201 2000_01_S3_30 Central Tendency: Normal Distributions
In a standard distribution, what is the greatest percent of the data that falls within 2 standard deviations of the mean?

- 1) 95
- 2) 81.5
- 3) 68
- 4) 34

- 202 2000_01_S3_31 Functions: Inverses of
In the diagram below, figure b is the reflection of $y = 2^x$ in the line $y = x$.

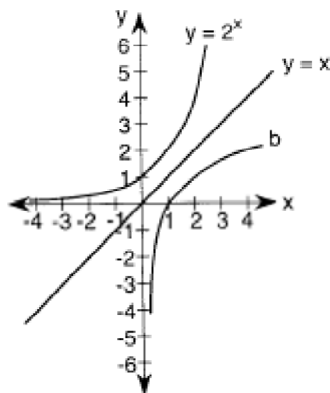

Which is an expression for the equation of figure b ?

- 1) $y = (-2)^x$
 - 2) $y = 2^{-x}$
 - 3) $y = \log_2 x$
 - 4) $y = \log_x 2$
- 203 2000_01_S3_32 Quadratics: Inequalities
What is the solution set of the inequality $x^2 + 3x - 10 > 8$?
- 1) $\{x | -6 < x < 3\}$
 - 2) $\{x | x < -6 \text{ or } x > 3\}$
 - 3) $\{x | -3 < x < 6\}$
 - 4) $\{x | x < -3 \text{ or } x > 6\}$
- 204 2000_01_S3_33 Binomial Expansions
What is the third term in the expansion of $(x + 2y)^5$?
- 1) $10x^3y^2$
 - 2) $40x^3y^2$
 - 3) $80x^2y^3$
 - 4) $20x^2y^3$

- 205 2000_01_S3_34 Numbers: Imaginary
If $f(x) = x^2$, what is the value of $f(i^3)$?
- 1) 1
 - 2) -1
 - 3) i
 - 4) $-i$

- 206 2000_01_S3_35 Variation: Inverse
If x varies inversely as y and $x = 12$ when $y = 3$, what is the value of x when $y = 9$?

- 1) 36
- 2) $\frac{1}{3}$
- 3) $\frac{1}{4}$
- 4) 4

- 207 2000_01_S3_36 Circles: Chords, Secants and Tangents
In the accompanying diagram of circle O , $AOED$ is a diameter, PD is a tangent, PBA is a secant, chords BD and BEC are drawn, $m\angle DAB = 43$, and $m\angle DEC = 72$.

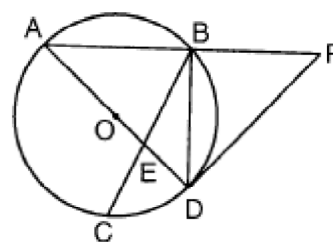

Find: $m\angle BDP$, $m\widehat{AB}$, $m\widehat{AC}$, $m\angle P$, $m\angle CBD$

- 208 2000_01_S3_37a Probability: Binomial with "At Least or At Most"
In the month of February at a ski resort, the probability of snow on any day is $\frac{3}{4}$. What is the probability that snow will fall on every day of a 5-day trip to that resort in February? What is the probability that snow will fall on *at least* 3 days of that 5-day trip in February?
- 209 2000_01_S3_37b Central Tendency: Dispersion
Using the scores in the table below, find the standard deviation to the *nearest tenth*.

Scores	Frequency
60	2
65	6
70	4
75	8
80	5

- 210 2000_01_S3__38 Trigonometry: Law of Cosines
In parallelogram $ABCD$, $AD = 8$, $AB = 12$, and diagonal $BD = 15$. Find $\angle BAD$ to the *nearest degree*. Using this angle, find the area of parallelogram $ABCD$ to the *nearest tenth*.
- 211 2000_01_S3_39 Trigonometric Graphs
a. Find the period of the graph of $y = 3 \sin 2x$. [2]
b. On graph paper, sketch the graph of $y = 3 \sin 2x$ for one period. [4]
c. On the same set of axes, sketch the image of the graph drawn in part b after it is reflected in the x -axis. Label the graph c . [2]
d. Write an equation for the graph sketched in part c . [2]
- 212 2000_01_S3_40 Trigonometric Equations
Find, to the *nearest degree*, all positive values of θ less than 360° that satisfy the equation $2 \tan^2 \theta - 2 \tan \theta = 3$.
- 213 2000_01_S3_41a Logarithms
Given: $\log 2 = x$
 $\log 3 = y$
Express in terms of x and y : $\log \frac{2}{3}$
 $\log 12$
- 214 2000_01_S3_41b Exponential Functions and Equations
Using logarithms, find w to the *nearest hundredth*.
 $5^{2w} + 9 = 40$
- 215 2000_01_S3_42a Proofs: Trigonometric
For all values of θ for which the expressions are defined, prove the following is an identity:
$$\frac{\tan \theta - \cot \theta}{\tan \theta + \cot \theta} = 2 \sin^2 \theta - 1$$
- 216 2000_01_S3_42b Rationals: Solving
For all values of x for which the expression is defined, solve for x : $\frac{3}{x+3} + \frac{2}{x-4} = \frac{4}{3}$
- 217 2000_06_S3_01 Trigonometry: Law of Sines
In $\triangle ABC$, $\sin A = 0.3$, $\sin B = 0.8$, and $b = 12$. Find the length of side a .
- 218 2000_06_S3_02 Trigonometric Equations
If $f(x) = \sin 2x + \cos x$, find the value of $f\left(\frac{\pi}{2}\right)$.
- 219 2000_06_S3_03 Circles: Chords
An angle inscribed in a circle measures 80 degrees. What is the number of degrees in the intercepted arc?
- 220 2000_06_S3_04 Trigonometry: Finding Area
In $\triangle ABC$, $a = 1.3$, $b = 2.4$, and $m\angle C = 30$. Find the area of $\triangle ABC$.
- 221 2000_06_S3_05 Exponential Functions and Equations
Solve for x : $9^{2x} = 27^{x+1}$
- 222 2000_06_S3_06 Trigonometry: Terminal Sides of Angles
If $\sin A > 0$ and $\cot A > 0$, in which quadrant does the terminal side of $\angle A$ lie?
- 223 2000_06_S3_07 Transformations: Translations
A translation maps $P(3, -2)$ to $P'(1, 1)$. Under the same translation, find the coordinates of Q' , the image of $Q(-3, 2)$.
- 224 2000_06_S3_08 Quadratics: Difference of Perfect Squares
Factor completely: $9x^3 - x$
- 225 2000_06_S3_09 Equations: Absolute Value
Solve for all values of x : $|2x + 3| = 7$
- 226 2000_06_S3_10 Exponents
If $g(x) = 36^x$, evaluate $g\left(-\frac{1}{2}\right)$.
- 227 2000_06_S3_12 Fractions: Complex
Express in simplest form: $\frac{\frac{x-y}{y}}{\frac{1}{y} - \frac{1}{x}}$

228 2000_06_S3_13 Numbers: Complex
Express $\sqrt{-2} + \sqrt{-18}$ as a monomial in terms of i .

229 2000_06_S3_14 Circles: Radian Measure
In a circle whose radius is 2 centimeters, a central angle intercepts an arc of 6 centimeters. What is the number of radians in the central angle?

230 2000_06_S3_15 Trigonometry: Law of Sines - The Ambiguous Case
Determine the maximum number of triangles possible when $m\angle A = 150$, $a = 14$, and $b = 10$.

231 2000_06_S3_16 Radicals: Solving
Solve for x : $x - 1 = \sqrt{2x + 13}$

232 2000_06_S3_17 Transformations: Isometries
Which transformation is *not* an isometry?
(1) dilation
(2) rotation
(3) reflection
(4) translation

233 2000_06_S3_18 Trigonometric Identities
The expression $\sin \theta (\cot \theta - \csc \theta)$ is equivalent to
1) $\cos \theta - \sin^2 \theta$
2) $2 \cos \theta$
3) $-\sin \theta$
4) $\cos \theta - 1$

234 2000_06_S3_19 Trigonometric Graphs
Which equation is sketched in the accompanying graph?

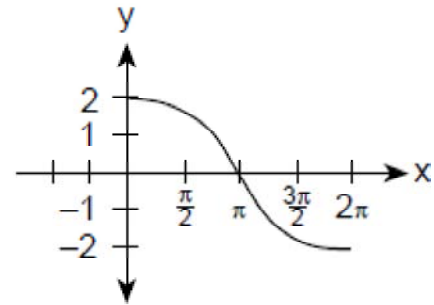

- 1) $y = \cos \frac{1}{2}x$
- 2) $y = \frac{1}{2} \cos x$
- 3) $y = 2 \cos \frac{1}{2}x$
- 4) $y = 2 \cos 2x$

235 2000_06_S3_20 Trigonometric Functions: Properties of
As angle x increases from $\frac{\pi}{2}$ to π , the value of $\sin x$ will
1) increase from -1 to 0
2) increase from 0 to 1
3) decrease from 0 to -1
4) decrease from 1 to 0

236 2000_06_S3_21 Quadratics: Inequalities
Which graph represents the solution set for the inequality $x^2 - x - 20 < 0$?

- 1)
- 2)
- 3)
- 4)

- 237 2000_06_S3_22 Scientific Notation
 If the fraction $\frac{123}{10,000}$ is expressed in the form 1.23×10^n , the value of n is
- 1) -1
 - 2) -2
 - 3) -3
 - 4) -4

- 238 2000_06_S3_23 Trigonometric Functions: Evaluating
 If $f(x) = \sin(\text{Arc tan } x)$, the value of $f(1)$ is
- 1) $\sqrt{2}$
 - 2) $\frac{\sqrt{2}}{2}$
 - 3) $\frac{\sqrt{3}}{2}$
 - 4) $\frac{\sqrt{3}}{3}$

- 239 2000_06_S3_24 Trigonometric Equations
 A solution of the equation $\cos 2\theta + \sin 2\theta = -1$ is
- 1) 240°
 - 2) 135°
 - 3) 45°
 - 4) -30°

- 240 2000_06_S3_25 Circles: Tangents
 In circle O , PA and PB are tangent to the circle from point P . If the ratio of the measure of major arc AB to the measure of minor arc AB is $5:1$, then $m\angle P$ is
- 1) 60
 - 2) 90
 - 3) 120
 - 4) 180

- 241 2000_06_S3_26 Functions: Defining
 Which equation is *not* a function?
- 1) $3x^2 + 4y^2 = 12$
 - 2) $y = 2 \cos x$
 - 3) $y = 2^x$
 - 4) $y = \log_2 x$

- 242 2000_06_S3_27 Numbers: Complex
 When the sum of $4 + 6i$ and $6 - 8i$ is graphed, in which quadrant does it lie?
- (1) I
 - (2) II
 - (3) III
 - (4) IV

- 243 2000_06_S3_28 Trigonometry: Unit Circles
 In the accompanying diagram, point $P(-0.6, -0.8)$ is on unit circle O .

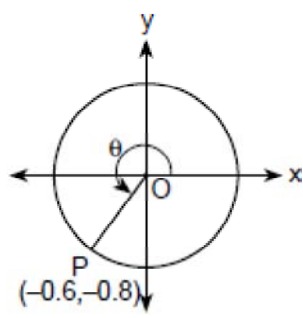

- What is the measure of angle θ to the nearest degree?
- 1) 143
 - 2) 217
 - 3) 225
 - 4) 233

- 244 2000_06_S3_29 Logarithms
 The expression $\log 12$ is equivalent to
- 1) $\log 6 + \log 6$
 - 2) $\log 3 + 2 \log 2$
 - 3) $\log 3 - 2 \log 2$
 - 4) $\log 3 \cdot \log 4$

- 245 2000_06_S3_30 Quadratics: Sum and Product of Roots
 In the equation $x^2 - 7x + 2 = 0$, the sum of the roots exceeds the product of the roots by
- 1) 9
 - 2) 5
 - 3) -9
 - 4) -5

246 2000_06_S3_31 Binomial Expansions
 What is the third term in the expansion of $(a - 3b)^4$?

- 1) $6a^2b^2$
- 2) $-6a^2b^2$
- 3) $54a^2b^2$
- 4) $-54a^2b^2$

247 2000_06_S3_32 Quadratics: Using the Discriminant
 The roots of the equation $2x^2 - 4x + k = 0$ are real and equal if k is equal to

- 1) -2
- 2) 2
- 3) -4
- 4) 4

248 2000_06_S3_33 Trigonometric Identities: Angle Sum or Difference
 The expression $\cos(270^\circ - A)$ is equivalent to

- 1) $\cos A$
- 2) $-\cos A$
- 3) $\sin A$
- 4) $-\sin A$

249 2000_06_S3_34 Central Tendency: Normal Distributions
 The scores on a test approximate a normal distribution with a mean score of 72 and a standard deviation of 9. Approximately what percent of the students taking the test received a score greater than 90?

- 1) $2\frac{1}{2}\%$
- 2) 5%
- 3) 10%
- 4) 16%

250 2000_06_S3_35 Probability: Binomial with "Exactly"
 Mr. and Mrs. Douville have six children. What is the probability that there is *exactly one* female child? [Assume that $P(\text{male}) = P(\text{female})$.]

- 1) $\frac{1}{64}$
- 2) $\frac{5}{64}$
- 3) $\frac{6}{64}$
- 4) $\frac{32}{64}$

251 2000_06_S3_36 Circles: Chords, Secants and Tangents
 In the accompanying diagram of circle O , tangent \overline{BA} , diameter \overline{AD} , secant \overline{BCE} intersects \overline{BE} at F , chords \overline{DE} and \overline{DC} are drawn, $m\angle AFB = 80$, and $m\widehat{AC} = 100$.

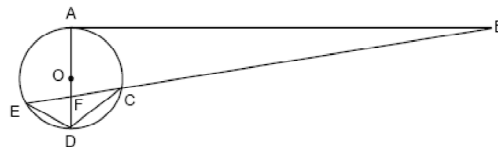

Find:

- a. $m\angle BED$ [2]
- b. $m\angle BAF$ [2]
- c. $m\widehat{ED}$ [2]
- d. $m\angle B$ [2]
- e. $m\angle EDC$ [2]

252 2000_06_S3_37 Trigonometric Graphs
 a. On the same set of axes, sketch and label the graphs of the equations $y = \frac{1}{2}\sin x$ and $y = -3\cos 2x$ in the interval $-\pi \leq x \leq \pi$. [8]

b. Using the graphs drawn in part a, find the number of values of x that satisfy the equation $\frac{1}{2}\sin x = -3\cos 2x$. [2]

253 2000_06_S3_38a Probability: Binomial with "At Least or At Most"

Assume that in the United States $\frac{1}{5}$ of all cars are red. Suppose you are driving down the highway and you pass 6 cars. What is the probability that *at most* one of the cars you pass is red? What is the probability that *at least* four of the cars you pass are red?

254 2000_06_S3_38b Central Tendency: Dispersion
 The scores on a mathematics test are 42, 51, 58, 64, 70, 76, 76, 82, 84, 88, 88, 90, 94, 94, 94, and 97. For this set of data, find the standard deviation to the *nearest tenth*.

255 2000_06_S3_39 Trigonometric Equations
 Find all values of x in the interval $0^\circ \leq x < 360^\circ$ that satisfy the equation $4\cos^2x - 5\sin x - 5 = 0$. Express your answer to the *nearest ten minutes* or *nearest tenth of a degree*.

256 2000_06_S3_40 Trigonometric Graphs
 a. On the same set of axes, sketch and label the graphs of the equations $xy = 8$ and $x = 2^y$. [6]
 b. On the same set of axes used in part a, sketch the reflection of $x = 2^y$ in the line $y = x$. Label it b . [3]
 c. Write an equation of the graph drawn in part b. [1]

257 2000_06_S3_41a Triangles: Vectors
 Two forces of 50 pounds and 69 pounds act on a body to produce a resultant of 70 pounds. Find, to the *nearest tenth of a degree* or *nearest ten minutes*, the angle formed between the resultant and the smaller force. [6]

258 2000_06_S3_41b Proofs: Trigonometric
 For all values of θ for which the expressions are defined, prove the following is an identity:
 $(\cot \theta + \csc \theta)(1 - \cos \theta) = \sin \theta$

259 2000_06_S3_42a Quadratics: Imaginary Solutions
 Solve for x and express your answer in simplest $a + bi$ form: $x^2 - 10x = -41$

260 2000_06_S3_42b Fractions: Complex
 Express in simplest form: $\frac{81 - x^2}{6x - 54} \div \frac{x^2 + 9x}{3x}$

261 2000_08_S3_01 Functional Notation
 If $f(x) = 3x - 4$ and $g(x) = x^2$, find the value of $f(3) - g(2)$.

262 2000_08_S3_02 Trigonometric Graphs
 What is the amplitude of the function $y = 3\sin 2x$?

263 2000_08_S3_03 Trigonometric Functions: Evaluating
 What is the value of $\sin(\text{Arc tan } \sqrt{3})$?

264 2000_08_S3_04 Circles: Tangents
 In the accompanying diagram, \overline{PQ} and \overline{PS} are tangents drawn to circle O , and chord \overline{OS} is drawn. If $m\angle P = 40$, what is $m\angle PQS$?

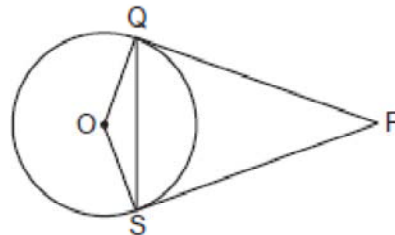

265 2000_08_S3_05 Trigonometry: Terminal Sides of Angles
 An angle that measures $\frac{5\pi}{3}$ radians is drawn in standard position. In which quadrant does the terminal side of the angle lie?

266 2000_08_S3_06 Numbers: Complex
 Express $4\sqrt{-25} - 2\sqrt{-81}$ as a monomial in terms of i .

267 2000_08_S3_07 Trigonometry: Finding Area
 In $\triangle ABC$, $a = 6$, $b = 10$, and $m\angle C = 30$. Find the area of $\triangle ABC$?

268 2000_08_S3_08 Exponential Functions and Equations
 Solve for the positive value of x : $x^{\frac{4}{3}} + 2 = 18$

269 2000_08_S3_09 Equations: Absolute Value
 What is the solution set of the equation $|2x - 1| = 5$

270 2000_08_S3_10 Transformations: Compositions of
 If point A has coordinates $(-3, 4)$, what are the coordinates of A' , the image of A under $r_{x = \text{axis}} \circ D_2$?

271 2000_08_S3_11 Quadratics: Difference of Perfect Squares
 Factor completely: $3x^3 - 192x$

272 2000_08_S3_12 Summations

Evaluate: $\sum_{k=0}^3 (2-k)^2$

273 2000_08_S3_13 Trigonometric Equations

Solve for the *smallest* non-negative value of θ :

$$\sqrt{3 \cos \theta + 1} = 2.$$

274 2000_08_S3_14 Fractions: Complex

Express $\frac{\frac{3}{x^2} + \frac{1}{x}}{1 - \frac{9}{x^2}}$ in simplest form.

275 2000_08_S3_15 Trigonometry: Unit Circles

Circle O has its center at the origin, $OB = 1$, and $BA \perp OA$. If $m\angle BOA = \theta$, which line segment shown has a length equal to $\cos \theta$?

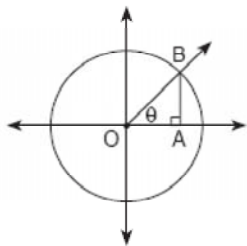

276 2000_08_S3_16 Scientific Notation

In scientific notation, the number $\frac{9}{1,000,000}$ is written as

- 1) 9.0×10^{-6}
- 2) 9.0×10^{-7}
- 3) 9.0×10^6
- 4) 9.0×10^7

277 2000_08_S3_17 Rationals: Undefined

For which value of θ is the fraction $\frac{1}{\cos \theta}$ undefined?

- 1) π
- 2) $\frac{\pi}{2}$
- 3) $\frac{\pi}{4}$
- 4) 0

278 2000_08_S3_18 Quadratics: Inequalities

What is the solution of the inequality

$$x^2 + 2x - 15 < 0?$$

- 1) $x < -5$ or $x > 3$
- 2) $-5 < x < 3$
- 3) $x < -3$ or $x > 5$
- 4) $-3 < x < 5$

279 2000_08_S3_19 Quadratics: Using the Discriminant

The roots of the equation $x^2 + kx + 3 = 0$ are real if the value of k is

- 1) 0
- 2) 2
- 3) 3
- 4) 4

280 2000_08_S3_20 Central Tendency: Normal Distributions

The heights of the members of a high school class are normally distributed. If the mean height is 65 inches and a height of 72 inches represents the 84th percentile, what is the standard deviation for this distribution?

- 1) 7
- 2) 11
- 3) 12
- 4) 137

281 2000_08_S3_21 Numbers: Imaginary

What is the greatest possible integral value of x for which $\sqrt{x-5}$ is an imaginary number?

- 1) 5
- 2) 6
- 3) 3
- 4) 4

282 2000_08_S3_22 Logarithms
The expression $\log 4x$ is equivalent to

- 1) $\log x^4$
- 2) $4 \log x$
- 3) $\log 4 + \log x$
- 4) $(\log 4)(\log x)$

283 2000_08_S3_23 Trigonometric Equations
Which value of θ satisfies the equation
 $2 \cos^2 \theta - \cos \theta = 0$?

- 1) $\frac{\pi}{3}$
- 2) $\frac{\pi}{4}$
- 3) $\frac{\pi}{6}$
- 4) 0

284 2000_08_S3_24 Probability: Binomial with "Exactly"
If the probability that Mike will successfully complete a foul shot is $\frac{4}{5}$, what is the probability that he will successfully complete exactly three of his next four foul shots?

- 1) $\frac{64}{625}$
- 2) $\frac{192}{625}$
- 3) $\frac{256}{625}$
- 4) $\frac{64}{125}$

285 2000_08_S3_25 Trigonometry: Law of Cosines
In $\triangle ABC$, $a = 1$, $b = 1$, and $m\angle C = 120$. Find the length of side b .

- 1) 1
- 2) $\sqrt{2}$
- 3) $\sqrt{2.5}$
- 4) $\sqrt{3}$

286 2000_08_S3_26 Circles: Chords, Secants and Tangents
In the accompanying diagram, PAB and PCD are secants drawn to circle O , $PA = 8$, $PB = 20$, and $PD = 16$.

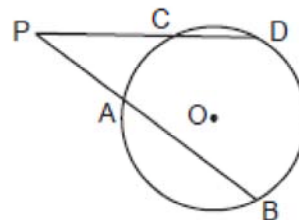

What is PC ?

- 1) 6.4
- 2) 10
- 3) 12
- 4) 40

287 2000_08_S3_27 Systems: Other Nonlinear
When the graphs of the equations $xy = -16$ and $y = x$ are drawn on the same set of axes, what is the total number of common points?

- (1) 1
- (2) 2
- (3) 3
- (4) 0

288 2000_08_S3_28 Functions: Inverses of
The inverse of the function $y = 2x - 5$ is

- 1) $y = \frac{1}{2}(x + 5)$
- 2) $y = \frac{1}{2}(x - 5)$
- 3) $y = 2x + 5$
- 4) $y = 5 - 2x$

289 2000_08_S3_29 Trigonometric Functions: Properties of
As x increases from π to 2π , the value of $\sin x$

- 1) increases, only
- 2) decreases, only
- 3) increases, then decreases
- 4) decreases, then increases

290 2000_08_S3_30 Exponential Functions and Equations

If $3^x \cdot y = 3^{x+1}$, what is the value of y ?

- 1) 1
- 2) -1
- 3) 3
- 4) $\frac{1}{3}$

291 2000_08_S3_31 Trigonometry: Law of Sines - The Ambiguous Case

If $m\angle A = 32$, $a = 5$ and $b = 3$, it is possible to construct

- 1) an obtuse triangle
- 2) two distinct triangles
- 3) no triangles
- 4) a right triangle

292 2000_08_S3_32 Trigonometric Identities

The expression $\frac{\sin x \cdot \cos x}{\tan x}$ is equivalent to

- 1) 1
- 2) $\sin^2 x$
- 3) $\cos x$
- 4) $\cos^2 x$

293 2000_08_S3_33 Numbers: Properties of Real

Which field property is *not* satisfied by the set of integers for addition and multiplication?

- (1)
- (2)
- (3)
- (4)
- 1) identity for multiplication
- 2) inverses for multiplication
- 3) identity for addition
- 4) closure for addition

294 2000_08_S3_34 Binomial Expansions

What is the fourth term of the expansion $(2x - y)^7$?

- 1) $16x^4y^3$
- 2) $35x^3y^4$
- 3) $-560x^4y^3$
- 4) $-560x^3y^4$

295 2000_08_S3_35 Trigonometry: Terminal Sides of Angles

If $\sec x < 0$ and $\tan x < 0$, then the terminal side of angle x is located in Quadrant

- 1) I
- 2) II
- 3) III
- 4) IV

296 2000_08_S3_36 Circles: Chords, Secants and Tangents

In the accompanying diagram of circle O , diameters \overline{BD} and \overline{AE} , secants \overline{PAB} and \overline{PDC} , and chords \overline{BC} and \overline{AD} are drawn; $m\widehat{AD} = 40$; and $m\widehat{DC} = 80$.

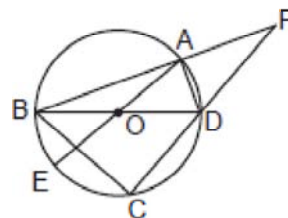

Find: $m\widehat{AB}$, $m\angle BCD$, $m\angle BOE$, $m\angle P$, $m\angle PAD$

297 2000_08_S3_37 Trigonometric Graphs

a. On the same set of axes, sketch and label the graphs of the equations $y = 4 \sin 2x$ and $y = -2 \cos \frac{1}{2}x$ in the interval $0 \leq x \leq 2\pi$. [8]

b. Based on the graph drawn in part a, how many values in the interval $0 \leq x \leq 2\pi$ satisfy the equation $4 \sin 2x = -2 \cos \frac{1}{2}x$? [2]

298 2000_08_S3_38 Equations: Logarithmic

Given: $f(x) = \log_3 x$

a. On graph paper, sketch and label the graph of $f(x) = \log_3 x$. [4]

b. On the same set of axes, rotate the graph drawn in part a 90° counterclockwise about the origin. Sketch this rotation and label it b. [4]

c. Write an equation of the function graphed in part b. [2]

- 299 2000_08_S3_39a Probability: Binomial with "At Least or At Most"
 Five marbles are in a jar. Two are red and three are white. Four marbles are selected at random with replacement. Find the probability that *at most* two red marbles are selected. Find the probability that *at least* three red marbles are selected.

- 300 2000_08_S3_39b Central Tendency: Dispersion
 Find, to the *nearest tenth*, the standard deviation of this set of data.

x_i	f_i
87	3
89	4
91	3
93	6
95	2

- 301 2000_08_S3_40a Trigonometric Equations
 In the interval $0^\circ \leq \theta < 360^\circ$, find all values of θ that satisfy the equation $1 + 2 \sin \theta = \csc \theta$.

- 302 2000_08_S3_40b Proofs: Trigonometric
 Prove the following identity: $\frac{\tan \theta}{\cot \theta} + 1 = \sec^2 \theta$

- 303 2000_08_S3_41a Quadratics: Sum and Product of Roots
 The roots of a quadratic equation are $r_1 = 3 + 2i$ and $r_2 = 3 - 2i$.
- (1) Find the sum of the roots r_1 and r_2 .
 - (2) Find the product of the roots r_1 and r_2 .
 - (3) Write a quadratic equation that has roots r_1 and r_2 .

- 304 2000_08_S3_41b Rationals: Solving
 Solve for x : $\frac{4x}{x+2} - \frac{12}{x} = 1$

- 305 2000_08_S3_42a Triangles: Vectors
 Two forces of 130 and 150 pounds yield a resultant force of 170 pounds. Find, to the *nearest ten minutes* or *nearest tenth of a degree*, the angle between the original two forces. [7]

- 306 2000_08_S3_42b Numbers: Complex
 Given: $z_1 = 1 + 3i$ and $z_2 = 5 + 2i$. Plot z_1 , z_2 , and $z_1 + z_2$ on graph paper. [3]

SG - The Solid Geometry Curriculum (1890-1930)

- 1 1890_01_SG_01 Definitions: Solid Geometry
Define cube; cylinder; frustum of a pyramid; radius of a sphere; axis of a cone; dihedral angle.
- 2 1890_01_SG_02 Proofs: Lines and Planes in Space
Prove that if two angles not situated in the same plane have their sides parallel and lying in the same direction, the angles will be equal and their planes parallel.
- 3 1890_01_SG_03 Proofs: General Polyhedrons
Prove that two rectangular parallelepipeds having equal altitudes are to each other as their bases.
- 4 1890_01_SG_04 Proofs: Solid Geometry
Prove that two triangular pyramids having equal bases and equal altitudes are equal in volume.
- 5 1890_01_SG_05 Proofs: Pyramids and Cones
Prove that the volume of a frustum of any triangular pyramid is equal to the sum of the volumes of three pyramids whose common altitude is that of the frustum, and whose bases are the lower base of the frustum, the upper base of the frustum, and a mean proportional between the two bases.
- 6 1890_01_SG_06 Proofs: Spheres
Prove that the surface of a sphere is equal to its diameter multiplied by the circumference of a great circle.
- 7 1890_01_SG_07 Definitions: Solid Geometry
Give the formula for finding each of the following: volume of a pyramid; volume of the frustum of a pyramid; convex (lateral area) of a cylinder; volume of a cone; volume of a sphere.
- 8 1890_01_SG_08 Solid Geometry: Prisms and Cylinders
Find the surface of a rectangular parallelepiped, the dimensions of whose base are 2 feet and 5 feet, and whose volume is 40 cubic feet.
- 9 1890_01_SG_09 Solid Geometry: Prisms and Cylinders
Find the lateral area and volume of a regular hexagonal prism, each side of whose base is 1 foot, and whose altitude is 10 feet.
- 10 1890_03_SG_01 Solid Geometry: Lines and Planes in Space
When are two planes parallel?
- 11 1890_03_SG_02 Definitions: Solid Geometry
Define dihedral angle; prism, cube, slant height of a regular pyramid; cylinder; conical surface; sphere.
- 12 1890_03_SG_03 Solid Geometry: General Polyhedrons
Distinguish between similar, equal, and equivalent polyhedrons.
- 13 1890_03_SG_04 Definitions: Solid Geometry
Write theorems including and completing the following conditions:
 - (a) If two planes be perpendicular to each other
 - (b) If a plane bisect a dihedral angle
 - (c) If a prism be cut by two parallel planes
 - (d) If a pyramid be cut by a plane parallel to its base
- 14 1890_03_SG_05 Proofs: Lines and Planes in Space
Prove that if a straight line and a plane be perpendicular to the same straight line they are parallel.
- 15 1890_03_SG_06 Proofs: Prisms and Cylinders
Prove that the volume of any prism is measured by the product of its base and altitude.
- 16 1890_03_SG_07 Proofs: Prisms and Cylinders
Prove that any triangular prism may be divided into three equivalent triangular pyramids.
- 17 1890_03_SG_08 Proofs: Spheres
Prove that every section of a sphere made by a plane is a circle.

- 18 1890_03_SG_09 Definitions: Solid Geometry
Give formulas for finding each of the following: lateral area of a cylinder; volume of a cone; area of a sphere; surface of a sphere.
- 19 1890_03_SG_10 Solid Geometry: Prisms and Cylinders
Find the entire surface of a right prism whose altitude is 16 feet and whose base is an equilateral triangle each side of which is 6 feet.
- 20 1890_06_SG_01 Definitions: Solid Geometry
Define polyhedral angles; parallelepiped; truncated prism; cone; sphere; icosahedrons; diagonal of a polyhedron.
- 21 1890_06_SG_02 Solid Geometry: Lines and Planes in Space
Mention four distinct sets of conditions which determine the position of a plane.
- 22 1890_06_SG_03 Proofs: Dihedral and Polyhedral Angles
Prove that the sum of any two of the plane angles formed by the edges of a trihedral angle is greater than the third.
- 23 1890_06_SG_04 Solid Geometry: Prisms and Cylinders
In any prism the sections made by parallel planes are polygons equal in all their parts. (*sic*)
- 24 1890_06_SG_05 Proofs: Pyramids and Cones
Prove that similar pyramids are to each other as the cubes of the homologous edges.
- 25 1890_06_SG_06 Proofs: Spheres
Prove that any plane perpendicular to the radius of a sphere at its outer extremity is tangent to the sphere at that point.
- 26 1890_06_SG_07 Definitions: Solid Geometry
Give formulas for finding the following: (a) Convex surface and (b) volume of a cone. (c) Volume of any pyramid. (d) Volume of a frustum of a cone.
- 27 1890_06_SG_08 Solid Geometry: Spheres
The circumference of a dome in the shape of a hemisphere is 66 feet; how many square feet of lead are required to cover it.
- 28 1890_06_SG_09 Solid Geometry: Pyramids and Cones
Given a pyramid whose volume is 512 cubic feet and altitude 8 feet; find the volume of a similar pyramid whose altitude is 12 feet and find also the area of the bases of each.
- 29 1900_06_SG_01 Definitions: Solid Geometry
Define *five* of the following: *projection of a point, polyhedral angle, prism, cylinder of revolution, control surface, small circle, directrix.*
- 30 1900_06_SG_02 Proofs: Lines and Planes in Space
Prove that two straight lines perpendicular to the same plane are parallel.
- 31 1900_06_SG_03 Proofs: Lines and Planes in Space
Prove that a straight line perpendicular to one of two parallel planes is perpendicular to the other.
- 32 1900_06_SG_04 Proofs: Prisms and Cylinders
Prove that two rectangular parallelepipeds which have equal bases are to each other as their altitudes, when these altitudes are incommensurable.
- 33 1900_06_SG_05 Solid Geometry: Pyramids and Cones
Complete and demonstrate the following: the volume of a triangular pyramid is equal to ...
- 34 1900_06_SG_06 Solid Geometry: Pyramids and Cones
Complete and demonstrate the following: the lateral area of a cone of revolution is equal to ...
- 35 1900_06_SG_07 Proofs: Spheres
Prove that every plane section of a sphere is a circle.
- 36 1900_06_SG_08 Proofs: Spheres
Prove that the surface of a sphere is two thirds that of the circumscribed cylinder of revolution.
- 37 1900_06_SG_09 Solid Geometry: Prisms and Cylinders
Find the volume and total surface of a regular prism 20 inches high, whose base is a regular hexagon each side of which is 4 inches.
NOTE: Use π instead of its approximate value 3.1416

- 38 1900_06_SG_10 Solid Geometry: Pyramids and Cones
The base of a regular pyramid 15 inches high is 6 inches square; a plane parallel to the base of the pyramid bisects its edges. Find a) the volume of the pyramid, b) the lateral surface of the pyramid, c) the area of the parallel section.
NOTE: Use π instead of its approximate value 3.1416
- 39 1900_06_SG_11 Solid Geometry: Spheres
Find the volume of a sphere inscribed in a cone whose elements and the diameter of whose base are each 8 inches.
NOTE: Use π instead of its approximate value 3.1416
- 40 1900_06_SG_12 Solid Geometry: Spheres
A hollow iron sphere 10 inches in diameter and 1 inch thick is melted and cast into a cylinder 4 inches in diameter; find the height of this cylinder.
NOTE: Use π instead of its approximate value 3.1416
- 41 1900_06_SG_13_14 Solid Geometry: Spheres
Find the surface of a sphere whose volume is equal to that of a regular tetrahedron each edge of which is 4 inches.
NOTE: Use π instead of its approximate value 3.1416
- 42 1900_06_SG_15 Solid Geometry: Spheres
Given a sphere whose radius is 6 inches; find the altitude of a cone of revolution whose volume equals that of the sphere and whose base is a great circle of the sphere.
NOTE: Use π instead of its approximate value 3.1416
- 43 1909_01_SG_01 Proofs: Lines and Planes in Space
State *four* ways in which a plane is determined and prove *one* of them.
- 44 1909_01_SG_02 Proofs: Dihedral and Polyhedral Angles
Prove that the sum of the face angles of any convex polyhedral angle is less than four right angles.
- 45 1909_01_SG_03 Proofs: Prisms and Cylinders
Prove that the bases of a cylinder are equal.
- 46 1909_01_SG_04 Proofs: Spheres
Prove that the area of the surface of a sphere is equivalent to the area of four great circles of the sphere.
- 47 1909_01_SG_05 Proofs: Pyramids and Cones
Prove that the volume of a triangular pyramid equals one third the product of its base and altitude.
- 48 1909_01_SG_06 Solid Geometry: Prisms and Cylinders
Find the weight of 52,800 linear feet of copper wire $\frac{5}{16}$ of an inch in diameter. [1 cu. Ft. of copper weighs 556 lb.]
- 49 1909_01_SG_07 Solid Geometry: Prisms and Cylinders
Find the number of cubic feet of earth in a railway embankment 2500 feet long, 10 feet high, 12 feet wide at the top and 42 feet wide at the bottom.
- 50 1909_01_SG_08 Solid Geometry: Spheres
Find the cost, at \$3.50 a square foot, of gilding a hemispheric dome whose diameter is 50 feet.
- 51 1909_01_SG_09 Solid Geometry: Spheres
A sphere of lead 10 inches in diameter is melted and cast into a cone 10 inches high; find the diameter of the base of the cone.
- 52 1909_01_SG_10 Solid Geometry: Pyramids and Cones
Find the capacity in cubic inches of a berry box in the form of a frustum of a pyramid 5 inches square at the top, $4\frac{1}{4}$ inches square at the bottom and $2\frac{1}{4}$ inches deep.
- 53 1909_01_SG_11 Solid Geometry: General Polyhedrons
Two tanks are in form similar solids; one holds 128 gallons, the other 250 gallons. If the first is 20 inches deep find the depth of the second.
- 54 1909_01_SG_12 Volume
The total surface area of a cube is 450 square inches; find its volume.

- 55 1909_06_SG__01 Proofs: Dihedral and Polyhedral Angles
Prove that if two angles, not in the same plane, have their sides respectively parallel and lying on the same side of the straight line joining their vertices, they are equal.
- 56 1909_06_SG__02 Proofs: Prisms and Cylinders
Prove that the volume of a triangular prism is equal to the product of its base by its altitude.
- 57 1909_06_SG__03 Proofs: Dihedral and Polyhedral Angles
Prove that the volumes of two triangular pyramids, having a triedral angle of one equal to a triedral angle of the other, are to each other as the product of the three edges of these triedral angles.
- 58 1909_06_SG__04 Proofs: Spherical Polygons
State and prove the proposition relating to the area of a spheric polygon.
- 59 1909_06_SG__05 Solid Geometry: General Polyhedrons
An isosceles trapezoid with bases 4 and 7 and altitude 4, is revolved on its longer base as an axis. Find the volume of the solid generated.
NOTE—Use π instead of its numeric value.
- 60 1909_06_SG__06 Solid Geometry: Pyramids and Cones
A cone 5 feet high is cut by a plane parallel to the base and 2 feet from the base; the volume of the frustum thus formed is 294 cubic feet. Find (a) the volume of the cone, (b) the volume of the part cut off by the plane.
NOTE—Use π instead of its numeric value.
- 61 1909_06_SG__07 Solid Geometry: Prisms and Cylinders
A cylindrical tank 10 feet long and 5 feet in diameter, lying with its axis horizontal, contains gasoline to the depth of 15 inches at the middle of the cross section. How much gasoline is there in the tank?
NOTE—Use π instead of its numeric value.
- 62 1909_06_SG__08 Locus
Find all possible locations of a point that is equidistant from two given points in space and at a given distance from a third point.
- 63 1909_06_SG__09 Proofs: Spherical Polygons
Prove that the exterior angle of a spheric triangle is less than the sum of the two opposite interior angles.
- 64 1909_06_SG__10 Proofs: Spheres
Prove that the area of a zone of one base is equal to the area of a circle whose radius is the chord of the generating arc of the zone.
- 65 1920_01_SG_01 Proofs: Lines and Planes in Space
Prove that the intersection of two parallel planes with a third plane are parallel.
- 66 1920_01_SG_02 Proofs: Dihedral and Polyhedral Angles
Prove that the sum of the face angles of a convex polyhedral angle is less than four right angles.
- 67 1920_01_SG_03 Proofs: General Polyhedrons
Prove that the volume of a triangular prism is equal to the product of its base and altitude.
- 68 1920_01_SG_04 Proofs: Spheres
Prove that the line connecting the center of a sphere and the center of a small circle of the sphere is perpendicular to the plane of the circle.
- 69 1920_01_SG_05 Proofs: Spheres
Prove that the surface of a sphere is equal to the product of the diameter by the circumference of a great circle of the sphere.
- 70 1920_01_SG_06 Solid Geometry: Prisms and Cylinders
A right circular cylinder is circumscribed about a sphere. Show that (a) the surface of the sphere is equivalent to $\frac{2}{3}$ of the total surface of the cylinder, (b) the volume of the sphere is $\frac{2}{3}$ of the volume of the cylinder. [No authorities (reasons) are required in answering this question.]
- 71 1920_01_SG_07 Proofs: Pyramids and Cones
In the pyramid $A-BCD$, prove that the lines joining in order the mid points of BC , AC , AD , and BD form a parallelogram.

72 1920_01_SG_08 Proofs: Dihedral and Polyhedral Angles
 Prove that if perpendiculars are let fall upon the faces of a dihedral angle from any point within the angle, the plan of the perpendiculars is perpendicular to the edge of the dihedral angle.

73 1920_01_SG_09 Solid Geometry: General Polyhedrons
 The total surface (T) of a regular tetrahedron is $100\sqrt{3}$ square units. Find the altitude (H) and the volume (V) of the solid.

74 1920_01_SG_10 Solid Geometry: Pyramids and Cones
 The frustum of a regular pyramid has square bases 8" and 4" respectively on a side, and an altitude of 15". Find the altitude of an equivalent pyramid whose base is a mid section of the frustum.

75 1920_01_SG_11 Solid Geometry: Spheres
 A lune whose angle is 40° is equivalent to a zone on the same sphere. Find the ratio of the altitude of the zone to the radius of the sphere.

76 1920_01_SG_12 Solid Geometry: Prisms and Cylinders
 Half of a regular hexagram inscribed (as shown in the drawing) in a semicircle whose radius is 12, is revolved about the diameter of the semicircle as an axis. Find the surface and the volume generated by the semipolygon.

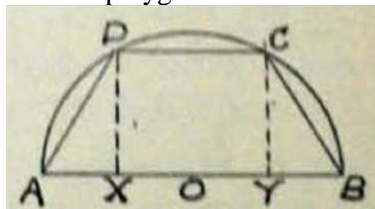

77 1920_06_SG_01 Proofs: Lines and Planes in Space
 Prove that a straight line perpendicular to one of two parallel planes is perpendicular to the other also.

78 1920_06_SG_02 Proofs: Dihedral and Polyhedral Angles
 Prove that the sum of any two face angles of a trihedral angle is greater than the third face angle.

79 1920_06_SG_03 Proofs: Prisms and Cylinders
 Prove that every section of a circular cone made by a plane parallel to its base is a circle.

80 1920_06_SG_04 Proofs: Dihedral and Polyhedral Angles
 Prove that in two polar triangles each angle of one is measured by the supplement of the side lying opposite to it in the other.

81 1920_06_SG_05 Definitions: Solid Geometry
a What is meant by the angle between a line and a plane?
b How would you locate the poles of a given great circle on a sphere?
c To what is the volume of any prism equal?
d To what is the lateral area of a frustum of a regular pyramid equal?
e To what is the volume of a circular cone equal?
f To what is the volume of a sphere equal?

82 1920_06_SG_06 Proofs: Lines and Planes in Space
 Prove that if a straight line is parallel to a plane, any plane perpendicular to the line is perpendicular to the plane.

83 1920_06_SG_07 Proofs: General Polyhedrons
 Prove that any line drawn through the center of a parallelepiped, terminating in a pair of opposite faces, is bisected at that point.

84 1920_06_SG_08 Solid Geometry: General Polyhedrons
 The corner of a cube is cut off by a plane passed through the outer extremities of the three edges meeting at the given corner. What part of the volume of the cube is thus removed?

85 1920_06_SG_09 Proofs: Spheres
 Prove that all tangents drawn to a sphere from any external point are equal.

86 1920_06_SG_10 Solid Geometry: Spherical Polygons
 A sphere of diameter 30" is cut by a plane 12" from the center. Find the area of a square inscribed in the circle of intersection.

- 87 1920_06_SG_11 Solid Geometry: Pyramids and Cones
A water pail is in the shape of a frustum of a cone, the diameters of the bottom and top being 9" and 12" respectively, and the height of the pail 14". How many quarts does it hold? [One gallon contains 231 cubic inches.]
- 88 1920_06_SG_12 Solid Geometry: Spherical Polygons
The sides of a spheric triangle on a sphere of radius 15" are 44° , 63° , and 97° respectively. Find the number of square inches in the area of the polar triangle.
- 89 1920_06_SG_13 Solid Geometry: Prisms and Cylinders
The cross section of a tunnel $2\frac{1}{2}$ miles in length is in the form of a rectangle 6 yards wide and 4 yards high, surmounted by a semicircle whose diameter is equal to the width of the rectangle. How many cubic yards of material were taken out in the construction of the tunnel?
[1 mile = 1760 yards. Use $\pi = 3.1416$.]
- 90 1920_09_SG_01 Proofs: Lines and Planes in Space
Prove that if two planes are parallel, a straight line perpendicular to one of the planes is perpendicular to the other.
- 91 1920_09_SG_02 Proofs: Dihedral and Polyhedral Angles
Prove that the sum of any two face angles of a trihedral angle is greater than the third face angle.
- 92 1920_09_SG_03 Proofs: Prisms and Cylinders
Complete and prove: The lateral area of any prism is equal to . . .
- 93 1920_09_SG_04 Proofs: Pyramids and Cones
Prove that every section of a circular cone made by a plane parallel to the base is a circle.
- 94 1920_09_SG_05 Proofs: Spherical Polygons
Prove that the sum of the angles of a spheric triangle is greater than two and less than six right angles.
- 95 1920_09_SG_06 Solid Geometry: General Polyhedrons
The volume of a regular tetrahedron is $18\sqrt{2}$ cubic units. Find the length of one edge.
- 96 1920_09_SG_07 Solid Geometry: Spheres
A sphere whose radius is 13 has inscribed in it a frustum of a cone whose bases are small circles of the sphere with radii 5 and 12 respectively. What is the difference in volume between the two solids?
- 97 1920_09_SG_08 Proofs: Prisms and Cylinders
Prove that if two intersecting planes are each tangent to a cylinder, their line of intersection is parallel to an element of the cylinder and also parallel to the plane containing the two elements of contact.
- 98 1920_09_SG_09 Solid Geometry: Pyramids and Cones
A pyramid with altitude 8 and base area 48 is cut by a plane parallel to the base and 2 from the vertex.
a What is the base area of the small pyramid?
b What is the ratio of the volumes of the two pyramids?
c What is the ratio of the total areas of the two pyramids?
- 99 1920_09_SG_10 Solid Geometry: Spheres
On a sphere whose radius is 12, compare the area of a zone whose altitude is 9 with the area of a lune whose angle is 54° .
- 100 1930_01_SG_01 Solid Geometry: General Polyhedrons
Every octahedron has _____ edges.
- 101 1930_01_SG_02 Solid Geometry: Dihedral and Polyhedral Angles
A dihedral angle is measured by its _____ angle.
- 102 1930_01_SG_03 Solid Geometry: General Polyhedrons
A diagonal of a rectangular solid is 23 inches; if the base is 14 inches by 18 inches, then the altitude is _____ inches.

- 103 1930_01_SG_04 Solid Geometry: Spheres
The plane of a small circle is 4 inches from the center of its sphere. If the diameter of the sphere is 10 inches, the length of the circles is _____ inches.
- 104 1930_01_SG_05 Solid Geometry: Pyramids and Cones
A prism and a pyramid have equal bases and the volume of the prism is 12 times the volume of the pyramid; the altitude of the prism is exactly _____ times the altitude of the pyramid.
- 105 1930_01_SG_06 Solid Geometry: Spherical Polygons
Angle A in spheric triangle ABC equals 70° ; the side $B'C'$ opposite A in the polar triangle has _____ degrees.
- 106 1930_01_SG_07 Solid Geometry: Spheres
The planes of any three great circles of a sphere intersect at the _____ of the sphere.
- 107 1930_01_SG_08 Solid Geometry: Spheres
The formula for the area of a zone of height H on a sphere of radius R is $S =$ _____
- 108 1930_01_SG_09 Solid Geometry: Pyramids and Cones
The figure generated by revolving a right triangle about one of its legs is a right circular _____
- 109 1930_01_SG_10 Solid Geometry: General Polyhedrons
The diagonals of a rectangular parallelepiped intersect in a point that is equidistant from the _____ of the parallelepiped.
- 110 1930_01_SG_11 Solid Geometry: Pyramids and Cones
Any section of a cone made by a plane through the vertex and cutting the base is a _____
- 111 1930_01_SG_12 Solid Geometry: Prisms and Cylinders
Two tanks in the form of cylinders of revolution are similar. The first holds 128 gallons and the second holds 250 gallons. If the first tank is 20 inches deep, the depth of the second tank is _____ inches.
- 112 1930_01_SG_13 Solid Geometry: General Polyhedrons
If each dimension of a cube is increased 20 per cent, then its total surface is increased _____ per cent.
- 113 1930_01_SG_14 Solid Geometry: Lines and Planes in Space
A line segment makes an angle of 60° with a plane. If its projection on the plane is $11\frac{1}{2}$ inches, then the line segment is _____ inches long.
- 114 1930_01_SG_15 Solid Geometry: Pyramids and Cones
If a pyramid is cut by a plane parallel to its base, the edges and altitude are divided _____
- 115 1930_01_SG_16 Solid Geometry: Lines and Planes in Space
Directions – State whether the following statement is true or false:
Two lines parallel to the same plane are parallel.
- 116 1930_01_SG_17 Solid Geometry: Spheres
Directions – State whether the following statement is true or false:
The surface of a sphere of radius 5 inches equals the sum of the surface of two spheres having radii of 2 inches and 3 inches.
- 117 1930_01_SG_18 Prisms and cylinders
Directions – State whether the following statement is true or false:
If a right section of a prism is a rectangle, the adjacent lateral faces are perpendicular to each other.
- 118 1930_01_SG_19 Solid Geometry: Prisms and Cylinders
Directions – State whether the following statement is true or false:
A regular prism can be inscribed in any *circular* cylinder.
- 119 1930_01_SG_20 Solid Geometry: Pyramids and Cones
Directions – State whether the following statement is true or false:
The slant height of a regular pyramid inscribed in a cone is equal to an element of the cone.

- 120 1930_01_SG_21 Proofs: Lines and Planes in Space
Prove that if each of two intersecting planes is perpendicular to a third plane, their intersection is perpendicular to the third plane. [12]
- 121 1930_01_SG_22 Proofs: Spherical Polygons
Prove that the sum of the angles of a spheric triangle is greater than 180° and less than 540° . [12]
- 122 1930_01_SG_23 Proofs: Prisms and Cylinders
Prove that every section of a prism made by a plane parallel to a lateral edge is a parallelogram. [12]
- 123 1930_01_SG_24 Locus
What is the locus of points
- a* equidistant from two points? [3]
- b* equidistant from two intersecting planes? [3]
- c* equidistant from two parallel lines? [3]
- d* equidistant from three points not in one straight line? [3]
- [Neither proofs nor drawings required]
- 124 1930_01_SG_25 Solid Geometry: Pyramids and Cones
A regular pyramid with a square base has each of its 8 edges equal to 4 inches. Find (*a*) its total surface, (*b*) its volume. [4, 8]
- 125 1930_01_SG_26 Solid Geometry: Spherical Polygons
The sides of a spheric triangle on a sphere whose radius is 14 inches are 107° , 76° , and 87° ; find in square inches the area of the polar triangle. [Use $\pi = \frac{22}{7}$] [12]
- 126 1930_01_SG_27 Solid Geometry: Pyramids and Cones
Find the altitude of a cone of revolution if the radius of its base is 30 and if its volume equals the volume of a cylinder of revolution with diameter 36 and altitude 48. [12]
- 127 1930_01_SG_28 Solid Geometry: Spheres
A light is 18 feet from the center of a sphere whose diameter is 12 feet; find the area of the illuminated surface. [Leave answer in terms of π .] [12]
- 128 1930_06_SG_01 Solid Geometry: Lines and Planes in Space
Through a given point on a given line there can be but one _____ perpendicular to the line.
- 129 1930_06_SG_02 Solid Geometry: Lines and Planes in Space
Through a given point not on a given line there can be not more than one _____ parallel to the given line.
- 130 1930_06_SG_03 Solid Geometry: Lines and Planes in Space
If two planes intersect, it is possible to construct a _____ perpendicular to both planes.
- 131 1930_06_SG_04 Solid Geometry: Lines and Planes in Space
Through a given point there may be drawn _____ planes, each perpendicular to all the others.
- 132 1930_06_SG_05 Locus
The locus of points equidistant from the three vertices of a triangle is a _____.
- 133 1930_06_SG_06 Solid Geometry: Dihedral and Polyhedral Angles
Two face angles of a trihedral angle are 60° and 20° . The third face angle must be between _____ degrees and _____ degrees and may have any value between these limits.
- 134 1930_06_SG_07 Solid Geometry: Dihedral and Polyhedral Angles
Two vertical trihedral angles are always _____
- 135 1930_06_SG_08 Solid Geometry: Pyramids and Cones
The area of the base of any regular pyramid is _____ than its lateral area.

- 136 1930_06_SG_09 Solid Geometry: General Polyhedrons
The base of a pyramid is one of the faces of a rectangular parallelepiped and its vertex is in the opposite face. The volume of the rectangular parallelepiped is exactly _____ times the volume of the pyramid.
- 137 1930_06_SG_10 Solid Geometry: General Polyhedrons
The dimensions of a rectangular parallelepiped are as 2:3:6. If its diagonal is 25, its longest dimensions is _____.
- 138 1930_06_SG_11 Solid Geometry: Pyramids and Cones
If the radii of the bases of the frustum of a right circular cone are 3 inches and 6 inches and the altitude is 4 inches, then the lateral area is _____ square inches. [Leave answer in terms of π .]
- 139 1930_06_SG_12 Solid Geometry: Prisms and Cylinders
Any section of a circular cylinder made by a plane containing an element is a _____
- 140 1930_06_SG_13 Solid Geometry: Pyramids and Cones
If a pyramid has for its base an equilateral triangle 4 inches on a side and its altitude is 6 inches, then its volume is _____ cubic inches. [Leave answer in radical form.]
- 141 1930_06_SG_14 Solid Geometry: Spheres
The area on the earth's surface included between the meridians of longitude 20°W . and 60°W is _____ square miles. [Assume the radius of the earth to be 4000 miles and leave answer in terms of π .]
- 142 1930_06_SG_15 Solid Geometry: Spherical Polygons
If one side of a spheric triangle is 70° , then the angle opposite this side in the polar triangle contains _____ degrees.
- 143 1930_06_SG_16 Solid Geometry: Spheres
All parallel circles of a sphere have the same _____.
- 144 1930_06_SG_17 Solid Geometry: Spheres
When the capacity of a spheric balloon is multiplied by 8, the surface is increased by _____ per cent.
- 145 1930_06_SG_18 Solid Geometry: Spherical Polygons
If the angles of a triangle on sphere are 115° , 100° and 85° , its surface is _____ the surface of the sphere.
- 146 1930_06_SG_19 Solid Geometry: Spheres
Zones on the same sphere are equal only when their _____ are equal.
- 147 1930_06_SG_20 Polygons: Area of
A light is 6 feet from a wall. A piece of cardboard containing 18 square inches of surface is held between the light and the wall, 4 feet from the wall and parallel to it. The area of the shadow is _____ square inches.
- 148 1930_06_SG_21 Proofs: Lines and Planes in Space
Prove that if a line is perpendicular to a given plane, every plane that contains this line is perpendicular to the given plane. [12]
- 149 1930_06_SG_22 Locus
What is the locus of the points
a at a given distance from a given point? [3]
b at a given distance from a given line? [3]
c equidistant from the sides of a plane angle? [3]
d equidistant from all points on a circle? [3]
- 150 1930_06_SG_23 Proofs: General Polyhedrons
Prove that any straight line drawn through the mid-point of a diagonal of a parallelepiped and terminated by two opposite faces is bisected by this point. [12]
- 151 1930_06_SG_24 Solid Geometry: Spheres
If a right circular cylinder and a right circular cone, each of whose diameters is equal to an element, are inscribed in a sphere, prove that the total area of the cylinder is a mean proportional between the total area of the cone and the area of the sphere. [12]

- 152 1930_06_SG_25 Solid Geometry: General Polyhedrons
The lateral edges of an oblique parallelepiped are 6 inches long and make an angle of 60° with the base. The base is a parallelogram 8 inches by 12 inches with an included angle of 45° . Find the volume of the parallelepiped. [12]
- 153 1930_06_SG_26 Solid Geometry: Prisms and Cylinders
A right circular cylinder has a radius of 10 inches and is filled with water to a certain point. When a sphere is completely immersed in the water, the surface rises 5 inches. What is the radius of the sphere? [A solid when immersed in water displaces a volume of water equal to the volume of the solid.] [12]
- 154 1930_06_SG_27 Solid Geometry: Spheres
Two concentric spheres have radii of 13 inches and 15 inches. A plane intersects the two spheres 12 inches from their common center. Find the area of the ring formed by this intersection. [12]
- 155 1930_08_SG_01 Solid Geometry: Lines and Planes in Space
Two lines not in the same plane can not be perpendicular to the same _____.
- 156 1930_08_SG_02 Locus
The locus of points equidistant from the ceiling and floor of a rectangular room and x feet from the front wall is a _____.
- 157 1930_08_SG_03 Solid Geometry: Lines and Planes in Space
If a line segment is not parallel to a plane, it is _____ than its projection on a plane.
- 158 1930_08_SG_04 Solid Geometry: Dihedral and Polyhedral Angles
The difference between two face angles of a trihedral angle is _____ than the third face angle.
- 159 1930_08_SG_05 Solid Geometry: General Polyhedrons
If the diagonal of a cube is $12\sqrt{3}$ inches, its volume is _____ cubic inches.
- 160 1930_08_SG_06 Solid Geometry: Pyramids and Cones
If a triangular pyramid always has the same height, no matter on what face it rests, its faces are _____ triangles.
- 161 1930_08_SG_07 Solid Geometry: Pyramids and Cones
Two right circular cones have equal volumes; if the ratio of their altitudes is 4 : 1, the ratio of their radii is _____.
- 162 1930_08_SG_08 Solid Geometry: Pyramids and Cones
The lateral area of a regular square pyramid is 48 square feet; if the area of the base is 36 square feet, the lateral edge is _____ feet.
- 163 1930_08_SG_09 Solid Geometry: Pyramids and Cones
An element of a right circular cone is 6 inches long and makes an angle of 60° with the base; its lateral area in terms of π is _____ square inches.
- 164 1930_08_SG_10 Solid Geometry: Pyramids and Cones
The formula for the volume of any pyramid is $V =$ _____.
- 165 1930_08_SG_11 Solid Geometry: Pyramids and Cones
If a plane parallel to the base of a pyramid forms a section whose area is $\frac{1}{9}$ the area of the base, the plane will divide the corresponding altitude into two segments whose ratio is _____.
- 166 1930_08_SG_12 Solid Geometry: Spheres
The weight of 1200 lead balls 1 inch in diameter is the same as the weight of _____ lead balls 2 inches in diameter.
- 167 1930_08_SG_13 Solid Geometry: Spherical Polygons
Two sides of a given spheric triangle are 60° and 50° ; if the sum of the angles of the polar triangle is 350° , the third side of the given triangle contains _____ degrees.

- 168 1930_08_SG_14 Solid Geometry: Spheres
If the ratio of the areas of two spheres is 4 : 9, the ratio of their volumes is _____.
- 169 1930_08_SG_15 Solid Geometry: Prisms and Cylinders
If the lateral area of a right circular cylinder is equal to the sum of the areas of its bases, the altitude of the cylinder is equal to the _____ of the base.
- 170 1930_08_SG_16 Solid Geometry: Spheres
A sphere whose radius is 13 inches is cut by a plane 12 inches from the center of the sphere; the radius of the small circle thus formed is _____ inches.
- 171 1930_08_SG_17 Solid Geometry: Spheres
If the area of a lune is $\frac{1}{4}$ the surface of its sphere, the angle of the lune is _____ degrees.
- 172 1930_08_SG_18_20 Solid Geometry: Prisms and Cylinders
18-20 If an isosceles trapezoid with base 4 inches and 8 inches and altitude 3 inches is rotated about the shorter base as an axis, the volume of the solid generated is equal to the volume of a (a) _____ diminished by twice the volume of a (b) _____ of which the altitude is (c) _____ inches.
- 173 1930_08_SG_21 Proofs: Lines and Planes in Space
Prove that if two angles not in the same plane have their sides respectively parallel and extending in the same direction from their vertices, they are equal and their planes are parallel. [12]
- 174 1930_08_SG_22 Solid Geometry: Dihedral and Polyhedral Angles
Prove that if a line in one face of a dihedral angle is parallel to a line in the other face, each is parallel to the edge of the angle. [12]
- 175 1930_08_SG_23 Locus
It is desired to find the locus of all points in space (1) equidistant from the vertices of a given triangle ABC and at the same time (2) at a given distance d from side AB .
- a Describe the nature of *each* of the loci (1) and (2). [8]
- b In general, what will be the required locus? [2]
- c Under what condition would there be no locus? [2]
- 176 1930_08_SG_24 Solid Geometry: Lines and Planes in Space
a Given a plane MN and a point A not in MN ; show how you would construct AB , a perpendicular to MN . [Proof not required] [6]
- b Assuming AB drawn, explain how you would construct a plane through A making an angle of 45° with MN . [6]
- 177 1930_08_SG_25 Solid Geometry: Prisms and Cylinders
A vessel in the form of a right circular cylinder 8 inches in diameter is partly filled with water. When 100 balls, equal in size, are dropped into the cylinder, the level of the water rises 8 inches. If all of the balls are completely immersed in the water, find the diameter of each ball. [12]
- 178 1930_08_SG_26a Solid Geometry: Spherical Polygons
Find the number of square feet in the area of a spheric triangle if its angles are 120° , 80° , and 85° , and the radius of the sphere is 20 feet. [6]
- 179 1930_08_SG_26b Polygons: Area of
How many cubic inches of mahogany will be required to veneer the top of a table in the shape of a regular hexagon, each side of which measures 2 feet, the veneer being $\frac{1}{4}$ inch thick? [6]
- 180 1930_08_SG_27 Solid Geometry: Pyramids and Cones
A cone whose slant height is equal to the diameter of its base is inscribed in a given sphere and a similar cone is circumscribed about the same sphere. Find the ratio of the volumes of the two cones. [12]

SG - The Solid Geometry Curriculum (1940-1960)

- 181 1940_01_SG_01 Solid Geometry: Lines and Planes in Space
Any two lines parallel to the same ... are parallel to each other.
- 182 1940_01_SG_02 Solid Geometry: Lines and Planes in Space
Two planes P and Q are perpendicular to each other and a line l , not in Q , is perpendicular to P . Line l is ... to plane Q .
- 183 1940_01_SG_03 Solid Geometry: Dihedral and Polyhedral Angles
If the plane angle of a dihedral angle contains 60° , a point 10 inches from each face of the dihedral angle is ... inches from the edge.
- 184 1940_01_SG_04 Solid Geometry: Pyramids and Cones
A plane is passed parallel to the base of a cone and 2 inches from the vertex. If the ratio of the area of the section so formed to the area of the base is 1:9, the altitude of the cone is ... inches.
- 185 1940_01_SG_05 Solid Geometry: Prisms and Cylinders
If the lateral edge of a prism is 8 and the perimeter of the right section is 20, the lateral area of the prism is
- 186 1940_01_SG_06 Solid Geometry: Pyramids and Cones
If the slant height of a regular hexagonal pyramid is 8 and a base edge is 2, the lateral area of the pyramid is
- 187 1940_01_SG_07 Solid Geometry: Pyramids and Cones
The lateral area L of a frustum of a cone of revolution whose slant height is l and the radii of whose bases are r and r' is given by the formula $L = \dots$
- 188 1940_01_SG_08 Solid Geometry: Prisms and Cylinders
If the volumes of two similar cylinders are in the ratio 27:125, their total surface areas are in the ratio
- 189 1940_01_SG_09 Solid Geometry: Spheres
A lune whose angle is 10° contains ... spheric degrees.
- 190 1940_01_SG_10 Locus
Two points, A and B , are 25 inches apart. The locus of points 15 inches from A and 20 inches from B is a
- 191 1940_01_SG_11 Solid Geometry: Spherical Polygons
Two symmetric spheric triangles on the same sphere or on equal spheres are
- 192 1940_01_SG_12 Solid Geometry: Spherical Polygons
Indicate whether the following statement is *always* true, *sometimes* true, or *never* true .
The sum of the sides of a convex spheric polygon is less than 360° .
- 193 1940_01_SG_13 Solid Geometry: General Polyhedrons
Indicate whether the following statement is *always* true, *sometimes* true, or *never* true .
A regular polyhedron may have a regular hexagon as its face.
- 194 1940_01_SG_14 Solid Geometry: Prisms and Cylinders
Indicate whether the following statement is *always* true, *sometimes* true, or *never* true .
The section formed by a plane intersecting the elements of a circular cylinder is a circle.
- 195 1940_01_SG_15 Solid Geometry: Spherical Polygons
Indicate whether the following statement is *always* true, *sometimes* true, or *never* true .
The sum of the angles of a spheric quadrilateral is greater than 360° and less than 720° .
- 196 1940_01_SG_16 Solid Geometry: Pyramids and Cones
Indicate whether the following statement is *always* true, *sometimes* true, or *never* true .
If the radius of the base of a right circular cone whose altitude is h is increased by an amount x , the volume of the cone is increases by $\frac{1}{2} \pi x^2 h$.

197 1940_01_SG_17 Solid Geometry: Spheres
Indicate whether the following statement is *always* true, *sometimes* true, or *never* true .
Two zones on the same or equal spheres are to each other as their altitudes.

198 1940_01_SG_18 Solid Geometry: Dihedral and Polyhedral Angles
How many degrees are there in the angle formed by a diagonal of a cube and its projection on one of the faces? [Give answer correct to the *nearest degree*.]

199 1940_01_SG_19 Locus
The locus of points equidistant from three points not in the same straight line is (a) a point, (b) a line or (c) a plane. Which is correct, a, b, or c?

200 1940_01_SG_20 Solid Geometry: Spherical Polygons
If two spheric triangles on the same or equal spheres have equal perimeters, their polar triangles must is (a) be mutually equiangular, (b) be mutually equilateral or (c) have equal areas. Which is correct, a, b, or c?

201 1940_01_SG_21 Proofs: Lines and Planes in Space
Prove that a line perpendicular to one of two parallel planes is perpendicular to the other also. [10]

202 1940_01_SG_22 Proofs: Spheres
Prove that if a point on a sphere is at a quadrant's distance from each of two other points on the sphere, not the extremities of a diameter, it is the pole of the great circle passing through those points. [10]

203 1940_01_SG_23 Proofs: Prisms and Cylinders
Given a rectangular parallelepiped and any two of its diagonals
Prove:

- The two diagonals are equal [5]
- A sphere can be circumscribed about the parallelepiped. [5]

204 1940_01_SG_24 Proofs: Prisms and Cylinders
A sphere is inscribed in a right circular cylinder. Prove that the ratio of their total areas is equal to the ratio of their volumes. [10]

205 1940_01_SG_25 Solid Geometry: Pyramids and Cones
The lower base edge of a frustum of a regular triangular pyramid is e_1 , that of the upper base is e_2 , and the altitude is h . Starting with the formula for the volume of a prismatoid,

$$V = \frac{h}{6} (B + B' + 4m),$$

show that the volume of the frustum is given by the formula

$$V = \frac{h\sqrt{3}}{12} (e_1^2 + e_2^2 + e_1e_2). \quad [10]$$

* This question is based on one of the optional topics in the syllabus.

206 1940_01_SG_26 Solid Geometry: Pyramids and Cones
The accompanying figure represents a coal bin.

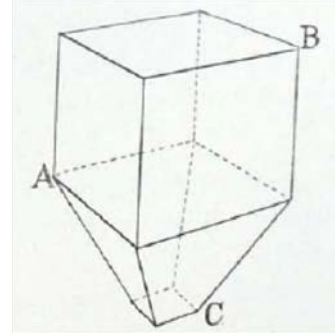

The portion AB is rectangular, with base 12 feet \times 12 feet and height 10 feet. AC is a frustum of a regular pyramid whose lower base edge is 2 feet and whose height is 15 feet. Find, correct to the *nearest ton*, the amount of coal necessary to fill the bin if one tone occupies 35 cubic feet of space.

[The formula for the volume of a frustum of a pyramid is $V = \frac{h}{3} (B + B' + \sqrt{BB'})$] [10]

207 1940_01_SG_27 Solid Geometry: Spherical Polygons
A zone and an equilateral spheric triangle one of whose angles is 75° are drawn on the same sphere. If the zone and the triangle are equal, show that the ratio between the altitude of the zone and the radius of the sphere is 1:8 [10]

- 208 1940_01_SG_28 Solid Geometry: General Polyhedrons
 $A - BCD$ is a regular tetrahedron of edge e , and AO is the altitude to the base BCD . Points D and O are joined and the line is extended to meet BC at E . AE is then drawn.
 a) Express AE in terms of e . [2]
 b) Express EO in terms of e . [2]
 c) Express AO in terms of e . [3]
 Find angle AEO correct to the nearest degree. [3]
- 209 1940_06_SG_01 Solid Geometry: Lines and Planes in Space
 Two lines are always parallel if (a) they do not intersect, (b) they are perpendicular to the same plane or (c) they are perpendicular to the same line.
- 210 1940_06_SG_02 Solid Geometry: Lines and Planes in Space
 Two planes are always parallel if (a) each contains one of two parallel lines, (b) they are perpendicular to the same plane or (c) one contains two intersecting lines each of which is parallel to the other plane.
- 211 1940_06_SG_03 Solid Geometry: Lines and Planes in Space
 Two planes are always perpendicular if (a) a line in one is perpendicular to their intersection, (b) a line in one is perpendicular to a line in the other or (c) one contains a line which is perpendicular to the other.
- 212 1940_06_SG_04 Solid Geometry: Lines and Planes in Space
 A line is always perpendicular to a given plane if (a) it is perpendicular to each of two intersecting lines in the given plane, (b) it is perpendicular to a given line in the plane or (c) it lies in a plane which is perpendicular to the given plane.
- 213 1940_06_SG_05 Solid Geometry: General Polyhedrons
 A diagonal of a parallelepiped always (a) is perpendicular to each of the other diagonals, (b) bisects each of the other diagonals or (c) is equal to each of the other diagonals.
- 214 1940_06_SG_06 Solid Geometry: Pyramids and Cones
 A plane is passed parallel to the base of a pyramid so that the section thus formed is equal to one half the base of the pyramid. If the altitude of the pyramid is h , the distance from the vertex of the pyramid to the section is (a) $\frac{h}{\sqrt{2}}$, (b) $\frac{h}{2}$ or (c) $\frac{h}{4}$.
- 215 1940_06_SG_07 Solid Geometry: General Polyhedrons
 A sphere can be inscribed in (a) any pyramid, (b) any tetrahedron *if and only if* it is regular or (c) any triangular pyramid.
- 216 1940_06_SG_08 Solid Geometry: Prisms and Cylinders
 The volume of any prism is equal to the product of (a) the perimeter of a right section and a lateral edge, (b) the area of a right section and a lateral edge or (c) the area of a right section and the altitude.
- 217 1940_06_SG_09 Solid Geometry: Lines and Planes in Space
 The projection of a circle on a plane is (a) always a circle, (b) always an ellipse or (c) sometimes a straight line segment.
- 218 1940_06_SG_10 Solid Geometry: Spherical Polygons
 If three angles of a spheric quadrilateral are right angles, the fourth angle is (a) acute, (b) right or (c) obtuse.
- 219 1940_06_SG_11 Solid Geometry: Prisms and Cylinders
 The lateral area of a cylinder of revolution whose altitude is equal to a diameter of the base is exactly ... of its total area.
- 220 1940_06_SG_12 Solid Geometry: Pyramids and Cones
 The lateral area of a frustum of a regular triangular pyramid whose base edges are 6 inches and 8 inches and whose slant height is 10 inches is ... square inches.
- 221 1940_06_SG_13 Solid Geometry: Spherical Polygons
 If the three sides of spheric triangle are 60° , 80° and 50° , the spheric excess of its polar triangle is ... degrees.

- 222 1940_06_SG_14 Solid Geometry: Spheres
A lune whose angle is 30° is drawn on a sphere whose radius is 3 inches. The area of the lune is ... inches. [Answer may be left in terms of π .]
- 223 1940_06_SG_15 Solid Geometry: Spheres
A zone whose area is 12π square inches is drawn on a sphere whose radius is 3 inches. The altitude of the zone is ... inches.
- 224 1940_06_SG_16 Solid Geometry: Pyramids and Cones
Indicate whether the following statement is *true* or *false*.
If the legs a and b of a right triangle are unequal, the volume of the cone of revolution formed by revolving the triangle about a as an axis is equal to the cone formed by revolving the triangle about b as an axis.
- 225 1940_06_SG_17 Solid Geometry: Prisms and Cylinders
Indicate whether the following statement is *true* or *false*.
Every section of a circular cylinder made by a plane passing through an element is a parallelogram.
- 226 1940_06_SG_18 Locus
Indicate whether the following statement is *true* or *false*.
The locus of points equidistant from two given intersecting planes and at a given distance from a fixed point on their line of intersection consists of two circles.
- 227 1940_06_SG_19 Solid Geometry: Lines and Planes in Space
Indicate whether the following statement is *true* or *false*.
If four straight lines meet in a point, it is impossible for each of them to be perpendicular to all the others.
- 228 1940_06_SG_20 Solid Geometry: General Polyhedrons
Indicate whether the following statement is *true* or *false*.
If two solids are similar but are not equal, it is possible for the ratio of their areas to equal the ratio of their volumes.
- 229 1940_06_SG_21 Proofs: Lines and Planes in Space
Prove that if two lines are parallel, every plane containing one of the lines, and only one, is parallel to the other. [10]
- 230 1940_06_SG_22 Proofs: Pyramids and Cones
Prove that if a pyramid is cut by a plane parallel to its base the section is a polygon similar to the base. [10]
- 231 1940_06_SG_23 Proofs: Lines and Planes in Space
Three planes, M , R and S , intersect in the same line l . From an external point P , lines a , b and c are drawn perpendicular to M , R and S respectively. Prove that a , b and c lie in the same plane. [10]
- 232 1940_06_SG_24 Solid Geometry: Spheres
A sphere of given radius r is to be constructed tangent to a given plane P with its center on a given line l .
a) Show how to locate the center of the sphere. [6]
b) In general, how many such spheres will there be? [2]
c) State a condition under which the construction would be impossible? [2]
- 233 1940_06_SG_25 Solid Geometry: General Polyhedrons
The upper base of a prismatoid is a rectangle 9.0 inches by 6.0 inches and the lower base is a rectangle 13.0 inches by 8.0 inches. The altitude of the prismatoid is 10.0 inches and the longer sides of the upper and lower bases are parallel.
a) Find, correct to the nearest cubic inch, the volume of the prismatoid. [The formula for the volume of a prismatoid is
$$V = \frac{h}{6} (B + B' + 4m)]$$
 [7]
b) If the dimensions of the prismatoid remain the same but the shorter side of one base is made parallel to the longer side of the other base, does the volume increase, decrease or remain the same? [3]
- * This question is based on one of the optional topics and may be used in either Group II or Group III

- 234 1940_06_SG_26 Solid Geometry: Pyramids and Cones
A right circular cone is inscribed in a sphere. The slant height of the cone is equal to the diameter of the base. Show that the ratio of the volume of the cone to the volume of the sphere is 9:32. [10]
- 235 1940_06_SG_27 Solid Geometry: Pyramids and Cones
Through a metal casting which has the form of a frustum of a cone of revolution a cylindrical hole 2.0 inches in radius is bored, the axis of the cylinder coinciding with the axis of the frustum. The radius of the upper base of the casting is 3.0 inches, the radius of the lower base is 5.0 inches and the height is 6.0 inches. Find, correct to the nearest cubic inch, the volume of the resulting solid. [Use $\pi = 3.14$] [The formula for the volume of a frustum of a cone is

$$V = \frac{\pi h}{3} (r_1^2 + r_2^2 + r_1 r_2)]$$
 [10]
- 236 1940_06_SG_28 Solid Geometry: Pyramids and Cones
The slant height s of a regular square pyramid makes with its projection on the base an angle A .
a) Show that the volume V of the pyramid is given by the formula $V = \frac{4}{3} s^2 \sin A \cos^2 A$
[4]
b) Find, correct to the nearest cubic inch, the value of V , if $s = 2.40$ inches and $A = 35^\circ$
[6]
- 237 1940_08_SG_01 Solid Geometry: Lines and Planes in Space
Indicate whether the following statement is *always* true, *sometimes* true or *never* true by writing the word *always*, *sometimes* or *never*.
Two lines perpendicular to the same line are parallel to each other.
- 238 1940_08_SG_02 Solid Geometry: Dihedral and Polyhedral Angles
Indicate whether the following statement is *always* true, *sometimes* true or *never* true by writing the word *always*, *sometimes* or *never*.
If a plane is perpendicular to both faces of a dihedral angle, it is perpendicular to the edge of the angle.
- 239 1940_08_SG_03 Solid Geometry: Lines and Planes in Space
Indicate whether the following statement is *always* true, *sometimes* true or *never* true by writing the word *always*, *sometimes* or *never*.
If two lines a and b are parallel and a third line c is parallel to the plane of a and b , then c is parallel to both a and b .
- 240 1940_08_SG_04 Solid Geometry: Dihedral and Polyhedral Angles
Indicate whether the following statement is *always* true, *sometimes* true or *never* true by writing the word *always*, *sometimes* or *never*.
The face angles of a trihedral angle may be 105° , 120° , 135° .
- 241 1940_08_SG_05 Solid Geometry: Lines and Planes in Space
Indicate whether the following statement is *always* true, *sometimes* true or *never* true by writing the word *always*, *sometimes* or *never*.
If the projections of two lines on a plane are parallel, the lines are parallel.
- 242 1940_08_SG_06 Solid Geometry: Spherical Polygons
Indicate whether the following statement is *always* true, *sometimes* true or *never* true by writing the word *always*, *sometimes* or *never*.
Any side of a spheric triangle is a minor arc of a great circle.
- 243 1940_08_SG_07 Solid Geometry: Spherical Polygons
Indicate whether the following statement is *always* true, *sometimes* true or *never* true by writing the word *always*, *sometimes* or *never*.
Each of the angles of an equiangular spheric triangle may be equal to 60° .
- 244 1940_08_SG_08 Solid Geometry: Spheres
Indicate whether the following statement is *always* true, *sometimes* true or *never* true by writing the word *always*, *sometimes* or *never*.
If a right circular cylinder circumscribes a sphere, the lateral area of the cylinder is greater than the surface of the sphere.

- 245 1940_08_SG_09 Solid Geometry: Prisms and Cylinders
Indicate whether the following statement is *always* true, *sometimes* true or *never* true by writing the word *always*, *sometimes* or *never*.
The lateral area of a prism is equal to the product of the perimeter of the base and a lateral edge.
- 246 1940_08_SG_10 Solid Geometry: General Polyhedrons
There can not be more than _____ regular convex polyhedrons.
- 247 1940_08_SG_11 Solid Geometry: Spherical Polygons
The sum of the sides of a convex spheric polygon is less than _____ degrees.
- 248 1940_08_SG_12 Solid Geometry: Prisms and Cylinders
A diagonal of a rectangular parallelepiped is 12 inches long and makes an angle of 34° with the base; the length of a diagonal of the base, correct to the *nearest tenth*, is _____ inches.
- 249 1940_08_SG_13 Volume
If the lateral area and the volume of a cube are equal in numerical value, an edge of the cube must be _____.
- 250 1940_08_SG_14 Solid Geometry: Spheres
A lune whose angle is 90° has an area of 81π square inches; the radius of the sphere on which this lune is drawn is _____ inches.
- 251 1940_08_SG_15 Solid Geometry: Pyramids and Cones
The lateral area of a regular square pyramid whose lateral edge is 5 and whose base edge is 6 is _____.
- 252 1940_08_SG_16 Solid Geometry: Pyramids and Cones
If the slant height of a cone of revolution is twice the radius of its base, the ratio of the lateral area to the area of the base is _____.
- 253 1940_08_SG_17 Solid Geometry: Prisms and Cylinders
The capacity in cubic feet of a tank in the form of a right circular cylinder whose height is 21 feet and the radius of whose base is 12 feet is _____ . [Use $\pi = \frac{22}{7}$]
- 254 1940_08_SG_18 Solid Geometry: Pyramids and Cones
If the radii of the upper and lower bases of a frustrum of a cone of revolution are 3 feet and 5 feet and the area of the curved surface is 24π square feet, the slant height of the frustrum is _____ feet.
- 255 1940_08_SG_19 Solid Geometry: Pyramids and Cones
The area of the base of a pyramid is 36; then the area of a section made by a plane parallel to the base and at a distance from the vertex equal to two thirds of the altitude is _____.
- 256 1940_08_SG_20 Solid Geometry: Spherical Polygons
If the sides of a spheric triangle contain 100° , 85° and 90° , the number of degrees in the largest angle of its polar triangle is _____.
- 257 1940_08_SG_21 Proofs: Lines and Planes in Space
Prove that if a line is perpendicular to a plane, every plane passed through the line is perpendicular to the given plane. [10]
- 258 1940_08_SG_22 Proofs: Spherical Polygons
Prove that in two polar triangles, each angle of one has the same measure as the supplement of the side lying opposite to it in the other. [10]
- 259 1940_08_SG_23 Proofs: Prisms and Cylinders
If any two lateral faces of a prism that are not parallel are rectangles, all of the lateral faces are rectangles and the prism is a right prism. [10]

- 260 1940_08_SG_24 Locus
 State in full what the locus is in each of the following: [No proof is required.] [10]
 a The locus of points equidistant from the three vertices of a given triangle.
 b The locus of points equidistant from the three edges of a given trihedral angle.
 c The locus of all lines which make the same angle with a given line at a point on the line.
 d The locus of the centers of all spheres that can be passed through two given points.
 e The locus of points equidistant from two given parallel planes and a given distance from a straight line which is perpendicular to one of the planes.

- 261 1940_08_SG_25 Solid Geometry: General Polyhedrons
 The total areas of two similar tetrahedrons are in the ratio 16 : 25 and the volume of the first tetrahedron is 320 cubic inches.
 a What is the volume of the second tetrahedron? [5]
 b If the base of the first tetrahedron is 240 square inches, what is the corresponding altitude?
 * This question is based on one of the optional topics in the syllabus.

- 262 1940_08_SG_26 Solid Geometry: Spheres
 A right circular cylinder 12 inches in diameter was partly filled with water. When an iron sphere was completely immersed in the water of the cylinder the surface of the water rose 2 inches. Find the radius of the sphere correct to the nearest tenth of an inch. [10]

- 263 1940_08_SG_27 Solid Geometry: Spherical Polygons
 A spheric triangle whose angles are 100° , 90° and 110° is drawn on a sphere whose radius is 6 inches. What must be the altitude of a zone on the same sphere for the area of the zone to equal the area of the spheric triangle. [10]

- 264 1940_08_SG_28 Solid Geometry: Pyramids and Cones
 Triangle ABC, whose sides are 11, 13 and 20, revolves through 360° about side BC as an axis. Find the volume and the total surface of the figure generated.

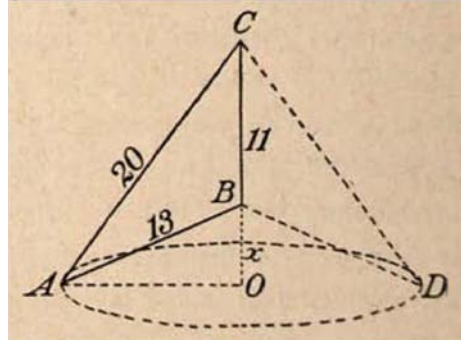

[Suggestion:
 $(AO)^2 = (13)^2 - x^2 = (20)^2 - (11 + x)^2$]
 [10]

- 265 1950_01_SG_01 Solid Geometry: Lines and Planes in Space
 Two planes perpendicular to the same ... are parallel to each other.
- 266 1950_01_SG_02 Solid Geometry: Dihedral and Polyhedral Angles
 If a point is 6 inches from each face of a dihedral angle and 12 inches from the edge of the angle, the dihedral angle contains ... degrees.
- 267 1950_01_SG_03 Solid Geometry: Dihedral and Polyhedral Angles
 Two face angles of a trihedral angle are 80 degrees and 110 degrees. The third face angle must be greater than 30 degrees and less than ... degrees and may have any value between these two limits.
- 268 1950_01_SG_04 Locus
 A plane bisects a sphere whose radius is 5 inches. The locus of points 2 inches from the plane and 1 inch from the sphere consists of ... circles.
- 269 1950_01_SG_05 Solid Geometry: Spherical Polygons
 If one side of a spherical triangle contains 80 degrees, the angle opposite this side in the polar triangle contains ... degrees.

- 270 1950_01_SG_06 Solid Geometry: Prisms and Cylinders
Find the volume of a regular hexagonal prism whose base edge is 6 and whose altitude is 10. [Answer may be left in radical form.]
- 271 1950_01_SG_07 Solid Geometry: Spherical Polygons
Find the length of a diagonal of a cube whose total surface area is 24 square inches. [Answer may be left in radical form.]
- 272 1950_01_SG_08 Solid Geometry: Pyramids and Cones
Express the volume of a regular square pyramid in terms of its altitude h and its base edge e .
- 273 1950_01_SG_09 Solid Geometry: General Polyhedrons
The total area of a regular tetrahedron is $4\sqrt{3}$. Find an edge.
- 274 1950_01_SG_10 Solid Geometry: Prisms and Cylinders
The volumes of two similar cylinders of revolution are in the ratio 1 : 8. Find the ratio of their total areas.
- 275 1950_01_SG_11 Solid Geometry: Pyramids and Cones
Find the lateral area of a frustum of a right circular cone the radii of whose bases are 6 and 8 and whose slant height is 10. [Answer may be left in terms of π .]
- 276 1950_01_SG_12 Solid Geometry: Spheres
The radius of a sphere is 13 inches. Find the area of a small circle whose plane is 5 inches from the center of the sphere. [Answer may be left in terms of π .]
- 277 1950_01_SG_13 Solid Geometry: Spheres
The area of a zone of a sphere is 120π and its altitude is 5. Find the radius of the sphere.
- 278 1950_01_SG_14 Solid Geometry: Spherical Polygons
If the sum of three angles of a spherical quadrilateral is 270 degrees, the fourth angle must be (a) less than 90 degrees, (b) equal to 90 degrees, (c) greater than 90 degrees. [Answer a, b or c.]
- 279 1950_01_SG_15 Solid Geometry: Spheres
Find the number of degrees in the angle of a lune whose area is 100 spherical degrees.
- 280 1950_01_SG_16 Solid Geometry: Spherical Polygons
Two angles of a spherical triangle are 100 degrees and 90 degrees and the area of the triangle is 60 spherical degrees. Find the number of degrees in the third angle of the triangle.
- 281 1950_01_SG_17 Solid Geometry: Lines and Planes in Space
If the blank in the following statement is replaced by one of the words always, sometimes, or never, the resulting statement will be true. Select the word that will correctly complete the statement.
A line perpendicular to a line in a plane is ... perpendicular to the plane.
- 282 1950_01_SG_18 Solid Geometry: Lines and Planes in Space
If the blank in the following statement is replaced by one of the words always, sometimes, or never, the resulting statement will be true. Select the word that will correctly complete the statement.
A line segment oblique to a plane is ... greater than its projection on the plane.
- 283 1950_01_SG_19 Solid Geometry: Lines and Planes in Space
If the blank in the following statement is replaced by one of the words always, sometimes, or never, the resulting statement will be true. Select the word that will correctly complete the statement.
Two lines parallel to the same plane are ... parallel to each other.
- 284 1950_01_SG_20 Solid Geometry: General Polyhedrons
If the blank in the following statement is replaced by one of the words always, sometimes, or never, the resulting statement will be true. Select the word that will correctly complete the statement.
Two diagonals of a rectangular parallelepiped are ... perpendicular to each other.
- 285 1950_01_SG_21 Proofs: Spherical Polygons
Prove that if the first of two spherical triangles is the polar triangle of the second, then the second is the polar triangle of the first. [10]

- 286 1950_01_SG_22 Solid Geometry: Lines and Planes in Space
If two planes are perpendicular to each other, a line perpendicular to one of them is parallel to the other. [10]
- 287 1950_01_SG_23 Proofs: Pyramids and Cones
Prove that if a plane divides the lateral edges of a pyramid proportionally, the plane is parallel to the base of the pyramid. [10]
- 288 1950_01_SG_24 Proofs: Lines and Planes in Space
Prove that if two lines are parallel, every plane containing one of the lines, and only one, is parallel to the other. [10]
- 289 1950_01_SG_25 Solid Geometry: Prisms and Cylinders
Given trapezoid $ABCD$ with angles A and B right angles. DA is 6 inches, AB is 4 inches and BC is 9 inches. The trapezoid is revolved through 360° about BC as an axis. Express, in terms of n , (a) the total area of the resulting solid, (b) the volume of the resulting solid. [5, 5]
- 290 1950_01_SG_26 Solid Geometry: Spherical Polygons
Find the area of a spherical triangle on a sphere whose radius is 7 inches, if the perimeter of its polar triangle is 180 degrees. [Use $\pi = \frac{22}{7}$] [10]
- 291 1950_01_SG_27 Solid Geometry: Pyramids and Cones
The slant height of a frustum of a regular square pyramid makes with the lower base an angle A . The lower base edge is a and the upper base edge is b . Show that the lateral area S of the frustum is given by the formula: $S = \frac{a^2 - b^2}{\cos A}$ [10]
- 292 1950_01_SG_28 Solid Geometry: Spheres
The volume of a sphere is 122 cu. in.
 a Using logarithms, find, to the *nearest tenth*, the radius of the sphere. [Use $\pi = 3.14$] [7]
 b Using the result obtained in answer to a , find, to the *nearest integer*, the area of the sphere. [3]
- 293 1950_06_SG_01 Solid Geometry: General Polyhedrons
Find the length of a diagonal of a rectangular parallelepiped whose dimensions are 3, 4 and 12.
- 294 1950_06_SG_02 Solid Geometry: Pyramids and Cones
Express the lateral area of the frustum of a regular square pyramid in terms of its base edges a and b and its slant height s .
- 295 1950_06_SG_03 Solid Geometry: General Polyhedrons
Find the number of degrees in the sum of all the face angles of a regular octahedron.
- 296 1950_06_SG_04 Solid Geometry: Lines and Planes in Space
Plane R intersects plane S in line m , forming an \angle of 60° . Point P in R is 12 inches from m . Find the distance of P from plane S . [Answer may be left in radical form.]
- 297 1950_06_SG_05 Solid Geometry: Prisms and Cylinders
The altitude of a cylinder of revolution is twice the radius of the base. Find the ratio of its lateral area to its total area.
- 298 1950_06_SG_06 Solid Geometry: Pyramids and Cones
Two similar cones of revolution have volumes in the ratio 1: 64. Find the ratio of the radii of their bases.
- 299 1950_06_SG_07 Solid Geometry: Spheres
Find the volume of a sphere whose radius is 3. [Answer may be left in terms of π .]
- 300 1950_06_SG_08 Solid Geometry: Spheres
Find the radius of the sphere on which a lune with an angle of 40° has an area of 16π square inches.
- 301 1950_06_SG_09 Solid Geometry: Pyramids and Cones
The altitude of a pyramid is 6 inches and the base is a right isosceles triangle with legs of 6 inches. Find the volume of the pyramid.
- 302 1950_06_SG_10 Locus
The locus of points at a given distance from a given line is (a) two lines (b) a cylindrical surface (c) two planes

- 303 1950_06_SG_11 Solid Geometry: Pyramids and Cones
If the radius of the upper base of the frustum of a right circular cone is half the radius of the lower base, the slant height is (a) shorter than (b) equal to (c) longer than the radius of the upper base.
- 304 1950_06_SG_12 Solid Geometry: Dihedral and Polyhedral Angles
The face angles of a trihedral angle may be (a) 40° , 70° , 110° (b) 100° , 120° , 150° (c) 70° , 100° , 120°
- 305 1950_06_SG_13 Solid Geometry: Spherical Polygons
If three angles of a spherical quadrilateral are each equal to 80° , the fourth angle is (a) less than (b) equal to (c) greater than 120° .
- 306 1950_06_SG_14 Locus
Given two points, A and B , 6 inches apart. The locus of points 6 inches from both A and B is (a) a straight line (b) a circle (c) a plane
- 307 1950_06_SG_15 Solid Geometry: Lines and Planes in Space
If the blank space in the following statement is filled by one of the words, always, sometimes or never, the resulting statement will be true. Select the word that will correctly complete the statement.
If plane R intersects planes S and T in two parallel lines, then planes S and T are . . . parallel.
- 308 1950_06_SG_16 Solid Geometry: Lines and Planes in Space
If the blank space in the following statement is filled by one of the words, always, sometimes or never, the resulting statement will be true. Select the word that will correctly complete the statement.
Through a given point it is ... possible to construct a plane perpendicular to each of two given intersecting planes.
- 309 1950_06_SG_17 Solid Geometry: Lines and Planes in Space
If the blank space in the following statement is filled by one of the words, always, sometimes or never, the resulting statement will be true. Select the word that will correctly complete the statement.
The projection of a square on a plane oblique to the plane of the square is ... a rectangle.
- 310 1950_06_SG_18 Solid Geometry: Lines and Planes in Space
If the blank space in the following statement is filled by one of the words, always, sometimes or never, the resulting statement will be true. Select the word that will correctly complete the statement.
A line which is perpendicular to a tangent to a circle at the point of tangency is ... perpendicular to the plane of the circle.
- 311 1950_06_SG_19 Solid Geometry: Lines and Planes in Space
If the blank space in the following statement is filled by one of the words, always, sometimes or never, the resulting statement will be true. Select the word that will correctly complete the statement.
A line parallel to one of two skew lines is ... parallel to the other.
- 312 1950_06_SG_20 Solid Geometry: Spherical Polygons
If the blank space in the following statement is filled by one of the words, always, sometimes or never, the resulting statement will be true. Select the word that will correctly complete the statement.
If spherical triangle I is congruent to spherical triangle II and is symmetric to spherical triangle III, then triangle II is ... symmetric to triangle III.
- 313 1950_06_SG_21 Solid Geometry: Lines and Planes in Space
Prove that a line perpendicular to one of two parallel planes is perpendicular to the other also. [10]
- 314 1950_06_SG_22 Proofs: Lines and Planes in Space
Triangle ABC has a right angle at C . Line segment AD is drawn perpendicular to plane ABC . Points E and F are the midpoints of line segments DC and DB respectively. Prove that line EF is perpendicular to the plane ADC . [10]
- 315 1950_06_SG_23 Proofs: Dihedral and Polyhedral Angles
Prove that a spherical angle is measured by the arc of the great circle described from its vertex as a pole and included between its sides, produced if necessary. [10]
- 316 1950_06_SG_24 Proofs: Lines and Planes in Space
Prove that two lines which intersect two given skew lines in four distinct points can not be coplanar. [10]

- 317 1950_06_SG_25 Solid Geometry: Pyramids and Cones
At a banquet for 70 people, tomato juice is served in glasses having the shape of a frustum of a right circular cone. The inside diameter of the bottom of the glass is $1\frac{1}{2}$ ". If the depth of the juice is 3" and the diameter of the upper surface of the liquid is 2", find, to the *nearest integer*, the number of quarts used. [1 quart contains $57\frac{3}{4}$ cubic inches.] [Use $\pi = \frac{22}{7}$.] [10]
- 318 1950_06_SG_26 Solid Geometry: Spherical Polygons
a The sides of a spherical triangle are 100° , 75° and 85° . Find the number of square inches in the area of the polar triangle if the radius of the sphere is 12 inches. [Answer may be left in terms of π .] [7]
b A zone on the same sphere has an area equal to the area of the polar triangle found in answer to part *a*. Find the height of the zone. [3]
- 319 1950_06_SG_27 Solid Geometry: Prisms and Cylinders
Find, to the *nearest pound*, the weight of 4 feet of lead pipe which is 2 inches in inside diameter and $\frac{1}{4}$ inch thick. Lead weighs 708 pounds per cubic foot. [Use $\pi = 3.14$.] [10]
- 320 1950_06_SG_28 Solid Geometry: Pyramids and Cones
Each face angle at the vertex of a regular triangular pyramid is θ and each base edge is e .
a Show that the lateral area S of the pyramid is given by the formula:
$$S = \frac{3e^2}{4 \tan \frac{\theta}{2}} \quad [6]$$

b Find S to the *nearest square inch* if $e = 6.7$ inches and $\theta = 56^\circ$.
[4]
- 321 1950_08_SG_01 Solid Geometry: Pyramids and Cones
Find the lateral area of a regular triangular pyramid whose base edge is 10 and whose slant height is 12.
- 322 1950_08_SG_02 Solid Geometry: Pyramids and Cones
The lateral area of a frustum of a cone of revolution is 427π square inches and the radii of its bases are 5 inches and 2 inches. Find its slant height.
- 323 1950_08_SG_03 Solid Geometry: Prisms and Cylinders
The radius of the base of a right circular cylinder is 3 and its altitude is 7. Find its *total* area. [Answer may be left in terms of π .]
- 324 1950_08_SG_04 Solid Geometry: Prisms and Cylinders
The radius of the base of a right circular cylinder is r , its altitude is $5r$ and its volume is 40π . Find r .
- 325 1950_08_SG_05 Solid Geometry: Spheres
Find the number of degrees in the angle of a lune if its area is $\frac{1}{36}$ of the area of the sphere on which it is drawn.
- 326 1950_08_SG_06 Solid Geometry: General Polyhedrons
Corresponding altitudes of two similar parallelepipeds are in the ratio 3: 4. Find the ratio of the volume of the smaller parallelepiped to the volume of the larger.
- 327 1950_08_SG_07 Solid Geometry: General Polyhedrons
Express the *total* area of a regular octahedron in terms of its edge e . [Answer may be left in radical form.]
- 328 1950_08_SG_08 Solid Geometry: Pyramids and Cones
A plane parallel to the base of a pyramid forms a section whose area is 20 square inches. If the base of the pyramid is 180 square inches and its altitude is 12 inches, how far is the plane from the vertex of the pyramid?
- 329 1950_08_SG_09 Solid Geometry: Lines and Planes in Space
A line segment is 12 inches in length. If its projection on a plane is 9.7 inches, find to the *nearest degree* its inclination to the plane.

- 330 1950_08_SG_10 Solid Geometry: Spheres
The area of a small circle of a sphere is 9π square inches and the plane of the circle is 4 inches from the center of the sphere. Find the radius of the sphere.
- 331 1950_08_SG_11 Solid Geometry: Spherical Polygons
In spherical triangle ABC , $\angle A = \angle B = 90^\circ$ and side $AB = 100^\circ$. How many degrees are there in $\angle C$?
- 332 1950_08_SG_12 Locus
How many points are there which are equidistant from all points on a given circle and also at a given distance, d , from the plane of the circle?
- 333 1950_08_SG_13 Solid Geometry: Dihedral and Polyhedral Angles
The locus of points equidistant from the faces of a dihedral angle and also equidistant from two points on the edge of the angle is a (a) point (b) line (c) plane
- 334 1950_08_SG_14 Solid Geometry: Prisms and Cylinders
The volumes of two prisms which have equal bases are to each other as (a) the cubes of their altitudes (b) the squares of their altitudes (c) their altitudes
- 335 1950_08_SG_15 Solid Geometry: Lines and Planes in Space
Plane P intersects plane Q . If line r is perpendicular to P and line s is perpendicular to Q , then r and s (a) must intersect (b) may intersect (c) may be parallel
- 336 1950_08_SG_16 Solid Geometry: Lines and Planes in Space
Plane P intersects plane Q . If line r is parallel to P , then r (a) must intersect Q (b) must be parallel to Q (c) may be parallel to Q
- 337 1950_08_SG_17 Solid Geometry: Prisms and Cylinders
If the following statement is always true, write true on the line at the right; if it is not always true, write false.
A right section of a circular cylinder is a circle.
- 338 1950_08_SG_18 Solid Geometry: Lines and Planes in Space
If the following statement is always true, write true on the line at the right; if it is not always true, write false.
Through a given line only one plane can be passed perpendicular to a given plane.
- 339 1950_08_SG_19 Solid Geometry: Dihedral and Polyhedral Angles
If the following statement is always true, write true on the line at the right; if it is not always true, write false.
If two face angles of a trihedral angle are 140° and 100° , the third face angle must be greater than 40° and must be less than 120° .
- 340 1950_08_SG_20 Solid Geometry: Spherical Polygons
If the following statement is always true, write true on the line at the right; if it is not always true, write false.
The polar triangle of an isosceles spherical triangle is isosceles.
- 341 1950_08_SG_21 Proofs: Lines and Planes in Space
Prove that if two planes are perpendicular to each other, a line drawn in one of them perpendicular to their intersection is perpendicular to the other. [10]
- 342 1950_08_SG_22 Proofs: Lines and Planes in Space
Two points A and B are on the same side of plane P . A line from A perpendicular to P intersects P at R . AR is extended its own length to A' . $A'B$ is drawn and intersects P at M .
a Prove that $AM + MB = A'B$
[4]
b Let M' be any point in P other than M .
Prove that $AM' + M'B > AM + MB$
[6]
- 343 1950_08_SG_23 Proofs: Spherical Polygons
Prove that the sum of the angles of a spherical triangle is greater than 180° and less than 540° .

- 344 1950_08_SG_24 Proofs: Lines and Planes in Space
Given two skew lines r and s .
 a Show how to pass a plane P through r and a plane Q through s so that P and Q will be parallel. [6]
 b Prove that P is parallel to Q . [3]
 c Can there be more than one pair of such planes? [1]
- 345 1950_08_SG_25 Solid Geometry: Spherical Polygons
A zone and a triangle are drawn on a sphere whose radius is 12". The area of the triangle is equal to the area of the zone. The angles of the triangle are 96° , 84° and 80° . Find:
 a the spherical excess of the triangle [2]
 b the area of the triangle in square inches [Answer may be left in terms of π .] [4]
 c the altitude of the zone to the *nearest tenth* of an inch. [4]
- 346 1950_08_SG_26 Solid Geometry: Pyramids and Cones
A storage bin has the form of a frustum of a quadrangular pyramid. The lower base is a rectangle 2' 3" by 3', the upper base is a rectangle 3' 9" by 5' and the depth is 4'. Find to the *nearest bushel* the capacity of the bin.
 $[V = \frac{h}{3} (B + B' + \sqrt{BB'})]$ and 1 bu. = approximately $1\frac{1}{4}$ cu. ft.] [10]
- 347 1950_08_SG_27 Solid Geometry: General Polyhedrons
The altitude to the base of an isosceles triangle is h , one of its base angles is θ and the volume of the solid formed by revolving the triangle through 180° about its altitude as an axis is V .
 a Show that $h = \sqrt[3]{\frac{3V \tan^2 \theta}{\pi}}$ [5]
 b Using logarithms, find h to the *nearest tenth* if $V = 50$ and $\theta = 75^\circ$
[Use $\pi = 3.14$.] [5]
- 348 1950_08_SG_28 Solid Geometry: General Polyhedrons
A cube is inscribed in a sphere whose diameter is d .
 a Express the volume of the cube in terms of d . [5]
 b Show that the volume of the sphere is approximately 2.7 times the volume of the cube. [5]
- 349 1960_01_SG_01 Solid Geometry: General Polyhedrons
A diagonal of a face of a cube is $\sqrt{2}$. Find a diagonal of the cube.
- 350 1960_01_SG_02 Solid Geometry: Prisms and Cylinders
A right section of an oblique prism is a square whose edge is s and a lateral edge of the prism is $3s$. Express the lateral area in terms of s .
- 351 1960_01_SG_03 Solid Geometry: Lines and Planes in Space
A line segment makes an angle of 77° with a plane and the length of its projection on the plane is 7.2. Find to the *nearest integer* the length of the segment.
- 352 1960_01_SG_04 Solid Geometry: Pyramids and Cones
The base of a pyramid is an equilateral triangle whose edge is 6, and the altitude of the pyramid is $2\sqrt{3}$. Find the volume of the pyramid.
- 353 1960_01_SG_05 Solid Geometry: Spheres
The area of a sphere is six times the area of a zone which is drawn on its surface. Express the altitude of the zone in terms of the radius of the sphere.
- 354 1960_01_SG_06 Solid Geometry: Spherical Polygons
Find the number of degrees in the sum of the angles of a spherical triangle whose area is one-tenth of the area of the sphere on which it is drawn.
- 355 1960_01_SG_07 Solid Geometry: Spheres
A lune whose area is 2π square inches is drawn on a sphere of radius 6 inches. Find the number of degrees in an angle of the line.

- 356 1960_01_SG_08 Solid Geometry: Spherical Polygons
If one angle of a birectangular spherical triangle is 60° , find the number of degrees in the longest side of its polar triangle.
- 357 1960_01_SG_09 Solid Geometry: Pyramids and Cones
The altitude of a cone of revolution is three times the radius (r) of its base. Express the volume of the cone in terms of r .
- 358 1960_01_SG_10 Solid Geometry: Prisms and Cylinders
The altitude of a right circular cylinder is equal to the diameter of its base. The lateral area of the cylinder is 100π . Find the radius of the base.
- 359 1960_01_SG_11 Solid Geometry: Pyramids and Cones
The slant height of the frustum of a regular square pyramid is 10. An edge of the lower base is 6 and an edge of the upper base is 4. Find the lateral area of the frustum.
- 360 1960_01_SG_12 Solid Geometry: Pyramids and Cones
The altitude of a pyramid is 6 inches. The area of a section of this pyramid formed by a plane parallel to the base and 4 inches from the base is 2 square inches. Find the number of square inches in the base of the pyramid.
- 361 1960_01_SG_13 Solid Geometry: Lines and Planes in Space
If the blank space in the following statement below is replaced by the word always, sometimes (but not always), or never, the resulting statement will be true. Select the word that will correctly complete each statement.
A plane is _____ determined by two nonintersecting lines.
- 362 1960_01_SG_14 Solid Geometry: Lines and Planes in Space
If the blank space in the following statement below is replaced by the word always, sometimes (but not always), or never, the resulting statement will be true. Select the word that will correctly complete each statement.
If two planes are perpendicular to each other, a line perpendicular to one of the planes is _____ parallel to the other plane.
- 363 1960_01_SG_15 Solid Geometry: Lines and Planes in Space
If the blank space in the following statement below is replaced by the word always, sometimes (but not always), or never, the resulting statement will be true. Select the word that will correctly complete each statement.
The projection of a rectangle on a plane oblique to the plane of the rectangle is _____ a parallelogram.
- 364 1960_01_SG_16 Solid Geometry: Pyramids and Cones
If the blank space in the following statement below is replaced by the word always, sometimes (but not always), or never, the resulting statement will be true. Select the word that will correctly complete each statement.
If the altitude of a cone of revolution is equal to the radius of the base, the area of the base is _____ equal to the lateral area of the cone.
- 365 1960_01_SG_17 Solid Geometry: Prisms and Cylinders
Two regular prisms with bases of six and four sides, respectively, have equal altitudes and equal base edges. The ratio of their volumes is:
(1) $\sqrt{3}:4$ (2) $3:2$ (3) $3\sqrt{3}:2$
(4) $27:8$
- 366 1960_01_SG_18 Solid Geometry: General Polyhedrons
The number of faces in each of the three regular polyhedrons whose faces are equilateral triangles is (1) 4, 8, and 20 (2) 4, 6, and 8 (3) 4, 8, and 12 (4) 4, 12, and 20
- 367 1960_01_SG_19 Solid Geometry: Dihedral and Polyhedral Angles
Two face angles of a trihedral angle are 78° and 108° . The third face angle may be (1) 194° (2) 174° (3) 78° (4) 24°

- 368 1960_01_SG_20 Locus
The locus of points equally distant from two intersecting lines and also at a given distance d from their point of intersection is
(1) one circle (2) two circles (3) two places (4) four points
- 369 1960_01_SG_21 Proofs: Lines and Planes in Space
Prove: If a line is perpendicular to a plane, every plane passed through this line is perpendicular to the given plane. [10]
- 370 1960_01_SG_22 Proofs: Spherical Polygons
Prove: If the first of two spherical triangles is the polar triangle of the second, then the second is the polar of the first. [10]
- 371 1960_01_SG_23 Solid Geometry: Spheres
The ratio of the altitude of a zone to the diameter of the sphere on which it is drawn is 1 : 5. The area of the zone is 80π .
 a Find the area of the sphere. [5]
 b If one of the bases of the zone is a great circle, find the area of the other base. [5]
[Answers may be expressed in terms of π .]
- 372 1960_01_SG_24 Proofs: Dihedral and Polyhedral Angles
From a point within a dihedral angle, perpendicular lines are drawn to each face.
 a Prove that the plane determined by these perpendiculars is perpendicular to the edge of the dihedral angle.
 b If the number of degrees in the dihedral angle is represented by n , express in terms of n the number of degrees in the angle formed by the two perpendicular lines. [3]
- 373 1960_01_SG_25 Locus
Lines s and t are perpendicular to plane M . The distance between the lines is 6. Each locus listed in column I is described briefly *once* and *only once* in column II. List the letters a - e on your answer paper, and after *each* letter write the *number* that indicates the description of that locus. [10]
- | <i>Column I</i> | <i>Column II</i> |
|---|---------------------------------|
| a Locus of points at a distance of 4 from both s and t | (1) a line parallel to s |
| b Locus of points at a distance of 3 from both s and t | (2) two lines parallel to s |
| c Locus of points at a distance of 3 from M | (3) four lines parallel to s |
| d Locus of points at a distance of 3 from both s and M | (4) one point |
| e Locus of points at a distance of 3 from s , t , and M | (5) two points |
| | (6) four points |
| | (7) two circles |
| | (8) a plane parallel to s |
| | (9) a plane parallel to M |
| | (10) two planes parallel to M |

374 1960_01_SG_26 Solid Geometry: Pyramids and Cones
 A regular pyramid has a pentagon for its base.

a Show that the area of the base is given by the formula $H = \frac{5}{4} e^2 \tan 54^\circ$ where $e =$ an edge of the base. [5]

b If the slant height of the pyramid makes an angle of 54° with the altitude of the pyramid, show that the altitude is given by the formula $h = \frac{e}{2}$. [3]

c Using the formula of parts *a* and *b*, write a formula for the volume of the pyramid in terms of the base edge e . [2]

375 1960_01_SG_27 Solid Geometry: Pyramids and Cones
 A reservoir is to have the shape of a hemisphere of radius 21 feet surmounted by a right circular cone. The base of the cone coincides with the base of the hemisphere. Find the number of feet in the height of the cone in order that the reservoir may have a total volume of 23,100 cubic feet. {Use the approximation $\pi = \frac{22}{7}$.} [10]

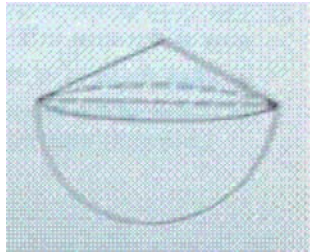

376 1960_01_SG_28 Solid Geometry: Pyramids and Cones
 In the figure at the right, B , C , and D are right angles. $AB = ED = a$. AE is a quadrant of a circle whose radius is $2a$. Find in terms of a the total area of the solid formed by rotating the figure through 360° about AB as an axis. [Answer may be expressed in terms of π .] [10]

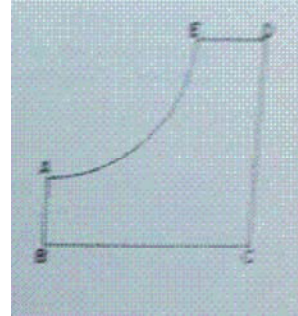

SMSG - Special Geometry (SMSG) Examination (1970)

- 1 1970_06_SMSG_01 Polygons: Interior and Exterior Angles of
Find the number of sides of a regular polygon if one of its exterior angles has a measure of 40.
- 2 1970_06_SMSG_02 Special Quadrilaterals: Rhombuses
Find the area of a rhombus whose diagonals measure 7 and 12.
- 3 1970_06_SMSG_03 Triangle Inequalities
In $\triangle XYZ$, $m\angle X = 60$ and $\angle X < \angle Y$. Name the longest side of $\triangle XYZ$.
- 4 1970_06_SMSG_04 Special Quadrilaterals: Parallelograms
In parallelogram $ABCD$, $m\angle A = (2x - 20)$ and $m\angle B = (x + 50)$. Find x .
- 5 1970_06_SMSG_05 Distance
Points A and B have coordinates of $(7, 3)$ and $(-1, -3)$ respectively. Find AB .
- 6 1970_06_SMSG_06 Midpoint
Find the coordinates of the midpoint of \overline{AB} if the coordinates of A and B are $(3, 0, 8)$ and $(7, 8, 4)$.
- 7 1970_06_SMSG_07 Circles: Chords
In a circle, chords \overline{ST} and \overline{UV} intersect at A . If $SA = (x - 3)$, $AT = (x + 3)$, $AV = (x - 1)$, and $UA = x$, find x .
- 8 1970_06_SMSG_08 Solid Geometry: Pyramids and Cones
A square pyramid has altitude of measure h . The length of one side of the base is b . Express in terms of b and h the volume of the pyramid.
- 9 1970_06_SMSG_09 Triangles: Mean Proportionals
Altitude CD is drawn to the hypotenuse of right triangle ABC . If $CD = 4$ and $AD = 2$, find DB .
- 10 1970_06_SMSG_10 Trigonometry: Finding Area
Find the area of $\triangle ABC$ if $m\angle C = 90$, $m\angle A = 30$, and $BC = 8$.
- 11 1970_06_SMSG_11 Transformations: Reflections
Point P has coordinates $(2, 5)$. What are the coordinates of the projection of P onto the y -axis?
- 12 1970_06_SMSG_12 Solid Geometry: Pyramids and Cones
Find the lateral surface area of a regular pyramid whose slant height is 5 and whose base is a regular pentagon of side length 2.
- 13 1970_06_SMSG_13 Polygons and Circles: Inscribed
If an equilateral triangle has an inscribed circle with radius 8, what is the radius of its circumscribed circle?
- 14 1970_06_SMSG_14 Trigonometry: Finding Angles
In $\triangle ABC$, $\angle C$ is a right angle and $m\angle A = 54$. If CM is the median to the hypotenuse, find $m\angle BCM$.
- 15 1970_06_SMSG_15 Circles: Center, Radius and Circumference
If the radius of circle A is 3 more than the radius of circle B , what is the difference in their circumferences?
- 16 1970_06_SMSG_16 Solid Geometry: General Polyhedrons
The diagonal of a rectangular parallelepiped has length 26. The lengths of the edges of the parallelepiped are 6, 24, and x . Find x .
- 17 1970_06_SMSG_17 Circles: Tangents
Point P is in the exterior of a circle whose center is A and whose radius is 15. If a tangent segment from P to the circle has length 8, find PA .
- 18 1970_06_SMSG_18 Equations: Writing Linear
Write an equation of the line which contains the point $(6, 2)$ and is parallel to the line whose equation is $3y = 2x - 7$.

- 19 1970_06_SMSG_19 Circles: Chords, Secants and Tangents
In the accompanying plane figure, \overline{PA} and \overline{PC} are tangent segments and \overline{AB} and \overline{BC} are chords.

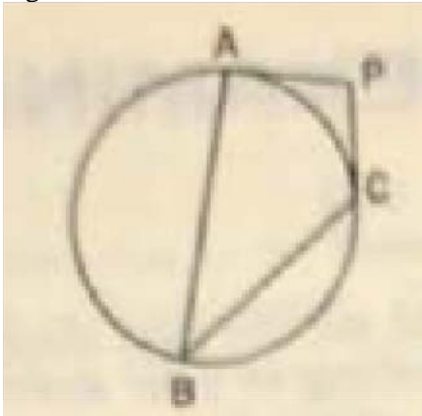

If $m\angle B = 40$, find $m\angle P$.

- 20 1970_06_SMSG_20 Special Quadrilaterals: Rectangles and Squares
In rectangle $ABCD$, $AB > AD$. The diagonals intersect at E such that $m\angle CEB = 60$. If $AD = 10$, find AE .

- 21 1970_06_SMSG_21 Proofs: Coordinate
Three points of a line, A , B , and C have coordinates r , s , and $r+s$, respectively. If $r > 0$ and $s < 0$, which point is between the other two?

- 22 1970_06_SMSG_22 Slope
The coordinates of the endpoints of \overline{AB} are $(3, 5)$ and $(x, 7)$. For what value of x will the slope of \overleftrightarrow{AB} be undefined?

- 23 1970_06_SMSG_23 Solid Geometry: Dihedral and Polyhedral Angles
Find the measure of the angle formed by any two face diagonals of a cube which meet at a vertex.

- 24 1970_06_SMSG_24 Triangle Inequalities
In $\triangle ABC$, $AB + CB = 2a$ and $AC = 2c$. It follows that
- 1) $a = c$
 - 2) $a > c$
 - 3) $c - a > 0$
 - 4) $2a < 2c$

- 25 1970_06_SMSG_25 Inequalities: Absolute Value
In a linear coordinate system $|x| \leq 2$ is represented by
- 1) One ray
 - 2) two rays
 - 3) a line segment
 - 4) two points

- 26 1970_06_SMSG_26 Circles: Chords
In the accompanying plane figure, \overline{DB} is a diameter, \overline{OA} is a radius, and \overline{DC} is a chord.

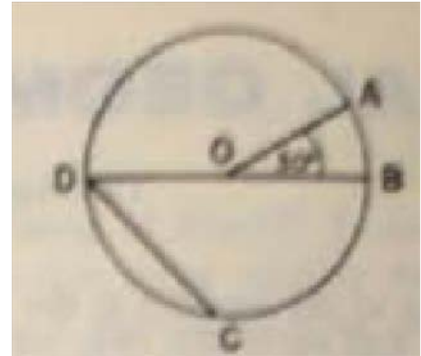

If $m\angle AOB = 30$ and $m\widehat{AB} = \frac{1}{3} m\widehat{BC}$, then $m\angle BDC$

equals

- 1) 5
 - 2) 30
 - 3) 45
 - 4) 90
- 27 1970_06_SMSG_27 Solid Geometry: Lines and Planes in Space
Which is always sufficient to determine a plane?
- 1) a point and a line
 - 2) two lines
 - 3) three points
 - 4) two intersecting lines
- 28 1970_06_SMSG_28 Logical Reasoning: Biconditional
Proving uniqueness and existence of an object is the same as proving that there is (are)
- 1) only one
 - 2) at least one
 - 3) more than one
 - 4) one and only one

- 29 1970_06_SMSG_29 Locus
Line L is perpendicular to plane E . The set of all points 5 inches from L and 2 inches from plane E consists of
- 1) exactly two circles
 - 2) one circle, only
 - 3) two parallel lines
 - 4) a cylindrical surface

- 30 1970_06_SMSG_30 Proofs: Polygon
Parallelogram $ABCD$ is not a rhombus and diagonal DB is drawn. Which correspondence is a congruence?
- 1) $ABC \leftrightarrow BDC$
 - 2) $ABD \leftrightarrow CBD$
 - 3) $ABD \leftrightarrow BCD$
 - 4) $ABD \leftrightarrow CDB$

- 31 1970_06_SMSG_31 Solid Geometry: Pyramids and Cones
The altitude of a cone is 12 inches. A cross section of the cone is 8 inches from the vertex. What is the ratio of the volume of the smaller cone formed to that of the larger cone?
- 1) 4:9
 - 2) 2:3
 - 3) 8:27
 - 4) 1:27

- 32 1970_06_SMSG_32 Medians, Altitudes, Bisectors and Midsegments
In $\triangle RST$, U is a point between R and S . If area $\triangle RTU = \text{area } \triangle TSU$, then for $\triangle RST$, TU must be
- 1) a median
 - 2) an altitude
 - 3) an angle bisector
 - 4) a perpendicular bisector

- 33 1970_06_SMSG_33 Solid Geometry: Spheres
A sphere and a right circular cone have radii of equal measure. Their volumes are also equal. If r represents the radius and h is the height of the cone, the ratio $r:h$ is
- 1) 3:4
 - 2) 1:4
 - 3) 4:3
 - 4) 4:1

- 34 1970_06_SMSG_34 Solid Geometry: Lines and Planes in Space
The line whose equation is $y = x + 2$ is the edge of two half-planes in the coordinate plane. The segment joining the points $(0,3)$ and $(3,0)$
- 1) lies completely in one half-plane
 - 2) is perpendicular to the edge
 - 3) coincides with the edge
 - 4) is parallel to the edge

- 35 1970_06_SMSG_35 Inequalities: Linear
On the set of coordinate axes on the answer sheet, sketch the graph of all (x,y) such that $-2 \leq x \leq 1$.

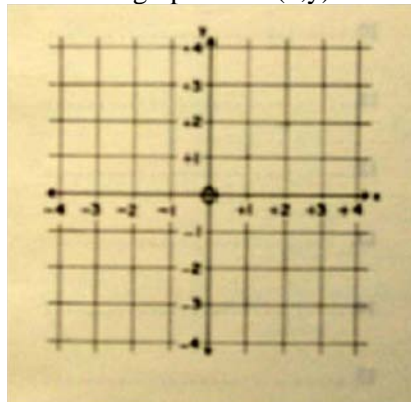

- 36 1970_06_SMSG_36 Proofs: Circle
Given: \overleftrightarrow{AD} tangent to the circle at A and secant \overleftrightarrow{BD} intersecting the circle at B and C

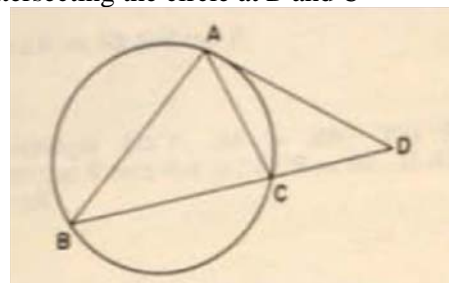

Prove: $BD \times CD = (AD)^2$ [10]

- 37 1970_06_SMSG_37 Proofs: Spheres
 Points A and B are on the intersection of plane E with a sphere whose center is at O . C is a point on the sphere and $\overline{CO} \perp E$ at point D .

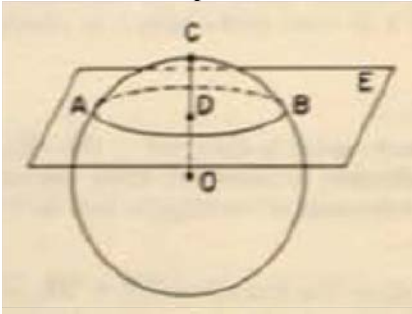

Prove: $\overline{AC} \cong \overline{BC}$ [10]

- 38 1970_06_SMSG_38 Polygons: Area of
 \overline{ABCD} is a trapezoid; $m\angle A = 60$ and $m\angle B = 90$.
 $\overline{CE} \parallel \overline{AD}$, $CE = AE$ and $EB = x$.

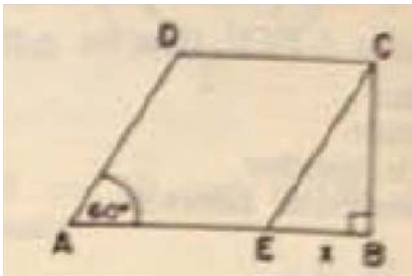

- Express the area of $\triangle EBC$ in terms of x . [4]
- Express the area of $AECD$ in terms of x . [3]
- If $x = 6$, find the area of $ABCD$. [3]

- 39 1970_06_SMSG_39 Circles: Tangents
 In the figure points $P(4, 3)$ and $Q(-4, 3)$ lie on a circle whose center is at the origin O . The tangents drawn at P and Q and the x -axis form $\triangle ABC$.

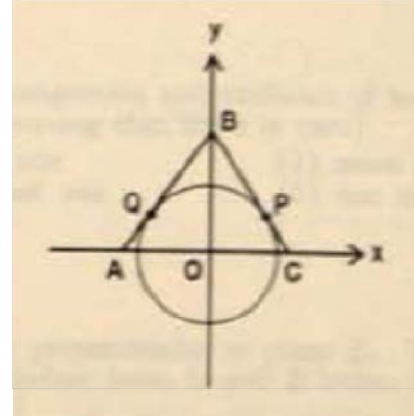

- Write an equation of the circle. [3]
- Find the slope of \overleftrightarrow{OP} . [2]
- Write an equation of the tangent \overleftrightarrow{BP} . [3]
- Find OB . [2]

- 40 1970_06_SMSG_40 Proofs: Circle
 In the accompanying plane figure \overline{ABCDE} is an inscribed regular pentagon and \overline{PS} is a tangent segment to the circle at A .

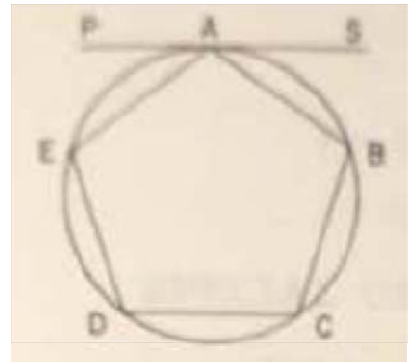

Prove: $\overline{PS} \parallel \overline{CD}$ [10]

- 41 1970_06_SMSG_41 Solid Geometry: Pyramids and Cones
 The accompanying diagram represents a capsule composed of a cone fitted with a cylinder so that the base of the cylinder is a cross section of the cone and the vertex of the cone is in the upper base of the cylinder. The radius of the cone is 9 and its height is 15. The height of the cylinder is 5.

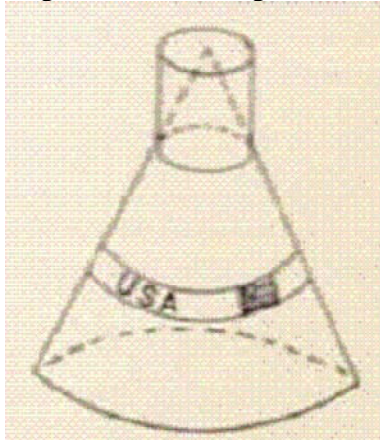

Find the:

- volume of the cone [2]
 - radius of the cylinder [2]
 - volume of the cylinder [2]
 - volume of the small cone inscribed in the cylinder [2]
 - volume of the capsule [2]
- 42 1970_06_SMSG_42a Proofs: Triangle
 In the accompanying plane figure, $m\angle A > m\angle B$ and $m\angle C > m\angle D$.

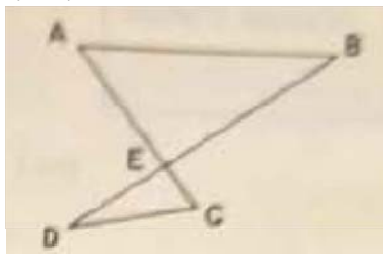

Prove: $DB > AC$ [5]

- 43 1970_06_SMSG_42b Proofs: Geometry
 Three distinct lines, m , n , and p are in one plane with $m \parallel p$ and n intersecting p at point A . Prove indirectly that n intersects m . [5]

- 44 1970_06_SMSG_42c Solid Geometry: Lines and Planes in Space
 In a three-dimensional coordinate system, XYZ , with origin O , the vertices of $\triangle ABC$ are $A(8, 0, 0)$, $B(0, 8, 0)$, and $C(8, 8, 6)$.
- Show that $\triangle ABC$ is isosceles. [2]
 - Write the equation of the plane that contains point C and is parallel to the $X - Y$ plane. [2]

ST - Spheric Trigonometry (1900)

- 1 1900_06_ST_01 Proofs: Spherical Polygons

In a right spheric triangle prove that $\sin A = \frac{\sin a}{\sin c}$,

$$\cos A = \frac{\tan b}{\tan c}, \tan A = \frac{\tan a}{\sin b}$$

- 2 1900_06_ST_02_3 Trigonometric Formulas: Derivations of

Assume $\cos A = \frac{\cos a - \cos b \cos c}{\sin b \sin c}$; derive the value

of $\tan \frac{1}{2} A$.

- 3 1900_06_ST_04_05 Solid Geometry: Spherical Polygons

Discuss the question of one solution, two solutions or no solutions when there are given an oblique angle and the opposite end of a right spheric triangle.

- 4 1900_06_ST_06 Solid Geometry: Spherical Polygons

Given B and a in a right spheric triangle; write the three logarithmic formulas which determine A , b , and c respectively, and also check the formula.

- 5 1900_06_ST_07 Solid Geometry: Spherical Polygons

Find the numeric values of A , b and c in question 6 when $B = 35^\circ 30'$ and $a = 106^\circ 40'$.

Note: Question #6 reads as follows:

Given B and a in a right spheric triangle; write the three logarithmic formulas which determine A , b , and c respectively, and also check the formula.

- 6 1900_06_ST_08_09 Solid Geometry: Spherical Polygons

Find the distance in miles between San Francisco, latitude $37^\circ 47'$ north, longitude $122^\circ 25'$ west, and Honolulu, latitude $21^\circ 18'$ north, longitude $157^\circ 50'$.
[Radius of earth = 3956 miles; $1^\circ = 69.16$ miles]

- 7 1900_06_ST_10_11 Solid Geometry: Spherical Polygons

In an oblique spheric triangle there are given $a = 42^\circ 40'$, $b = 83^\circ 20'$ and $A = 29^\circ 30'$; find the remaining parts.

- 8 1900_06_ST_12_13 Solid Geometry: Spherical Polygons

Given $c = 90^\circ$, $a = 122^\circ 53'$, and $b = 51^\circ 5'$; find the remaining parts.

- 9 1900_06_ST_14_15 Solid Geometry: Spherical Polygons

When the sun's declination is $12^\circ 30'$ north, at what hour will it rise at Albany, latitude $42^\circ 39'$ north.

TR - Trigonometry (1909-1960)

- 1 1909_01_TR_01 Trigonometric Equations
Solve $\sin^2 x - \cos x = \frac{3}{8}$; find x .
- 2 1909_01_TR_02 Trigonometric Ratios: Basic
The legs of a right triangle are 9 and 40; express as common fractions *six* trigonometric functions of the smallest angle.
- 3 1909_01_TR_03 Proofs: Trigonometric
Prove that $\sin^2 A + \cos^2 A = 1$
- 4 1909_01_TR_04 Proofs: Trigonometric
Prove that the cosine of the difference of two angles is equal to the product of the cosines plus the product of the sines.
- 5 1909_01_TR_05 Trigonometry: Law of Cosines
Two sides of a triangle are $a = 300$ feet, $b = 374$ feet; the included angle C is $74^\circ 50'$. Find the angles A and B .
- 6 1909_01_TR_06 Trigonometry: Finding Sides Using Two Triangles
From a point on the bank of a river the angle of elevation of a building on the opposite bank is $17^\circ 36'$; from a point 180 feet further away, in the same horizontal plan, the angle of elevation of the building is $10^\circ 15'$. Find the width of the river.
- 7 1909_01_TR_07 Triangle Inequalities
The sides of a triangle are 13, 14, 15; find the smallest angle.
- 8 1909_01_TR_08 Logarithms
Using logarithms, determine the numeric value of the following:
$$\sqrt{\frac{64 \times 35}{4000 + \frac{1}{2}}}$$
- 9 1909_01_TR_09 Solid Geometry: Spherical Polygons
Find the shortest distance measured on the earth's surface between Boston ($43^\circ 21' \text{ N.}, 71^\circ 8' \text{ W.}$) and Cape Town ($33^\circ 56' \text{ S.}, 18^\circ 28' \text{ W.}$). Assume the earth to be spheric and 7912 miles in diameter.
- 10 1909_01_TR_10 Solid Geometry: Spherical Polygons
Given in a spheric triangle $B = 98^\circ 30'$, $C = 67^\circ 20'$, $a = 60^\circ 40'$; find A .
- 11 1909_01_TR_11 Proofs: Spherical Polygons
Prove geometrically that in a right spheric triangle
$$\sin A = \frac{\sin a}{\sin c}$$
- 12 1909_01_TR_12 Solid Geometry: Spherical Polygons
A person in latitude 43° N. observes the altitude of the sun to be 24° when its declination is 15° N. ; find the hour of the day.
- 13 1909_06_TR_01 Proofs: Trigonometric
Prove the relation $\sin 2x = \frac{2 \tan x}{1 + \tan^2 x}$
- 14 1909_06_TR_02 Trigonometric Formulas: Derivations of
Derive the relation
$$\cos A + \cos B = 2 \cos \frac{1}{2}(A + B) \cos \frac{1}{2}(A - B)$$
- 15 1909_06_TR_03 Trigonometric Equations
Find two values of x that satisfy the following equation: $2 \cos^2 x + 5 \sin x = 4$
- 16 1909_06_TR_04 Trigonometry: Finding Area
A corner lot between two streets is in the form of a triangle; the frontage on the first street is 60 feet, on the second street 47 feet and the third side of the lot measures 71 feet. Find (a) the angle between the streets, (b) the area of the lot.
- 17 1909_06_TR_05 Trigonometry: Law of Cosines
One side of a parallelogram is 40 and the angles between this side and the diagonals are $34^\circ 10'$ and $43^\circ 30'$; find the other sides of the parallelogram.

- 18 1909_06_TR_06 Trigonometry: Finding Sides Using Two Triangles
From a certain point 6 feet above sea level, the angle of elevation of the top of an inaccessible bluff is found to be $15^{\circ}30'$; from a point 975 yards nearer the bluff and on the same level with the first point, the angle of elevation is $27^{\circ}20'$. Find the height of the bluff above sea level.
- 19 1909_06_TR_07 Proofs: Trigonometric
Prove geometrically the formula $\cos c = \cos a \cos b$.
- 20 1909_06_TR_08 Solid Geometry: Spherical Polygons
In an oblique spheric triangle given $a = 130^{\circ}5'$, $b = 58^{\circ}17'$, $c = 84^{\circ}36'$; find C .
- 21 1909_06_TR_09 Solid Geometry: Spherical Polygons
Given in a spheric triangle $A = 98^{\circ}25'$, $B = 58^{\circ}17'$, $a = 93^{\circ}20'$; find b and c .
- 22 1909_06_TR_10 Solid Geometry: Spherical Polygons
Find the distance in degrees between Boston, latitude $42^{\circ}21'N.$, longitude $71^{\circ}4'W.$, and Berlin latitude $52^{\circ}45'N.$, longitude $13^{\circ}24'E.$
- 23 1920_01_TR_01 Proofs: Trigonometric
a Prove $\frac{1 - \sin A}{1 + \sin A} = (\sec A - \tan A)^2$
b Prove without using the tables:
 $\frac{\sin 75^{\circ} + \sin 15^{\circ}}{\sin 75^{\circ} - \sin 15^{\circ}} = \sqrt{3}$
- 24 1920_01_TR_02a Radicals: N-Roots
Compute the value of $\sqrt[3]{\frac{(5.132)(0.0913)^2}{10.132}}$
- 25 1920_01_TR_02b Equations: Logarithmic
Solve the value of $\log\left(\frac{1}{x}\right)^2 = 3$
- 26 1920_01_TR_03 Trigonometric Functions: Evaluating
a Find the numerical values of the following:
 $\cos 240^{\circ}$; $\cot 750^{\circ}$; $\sin(-225)^{\circ}$; $\tan 540^{\circ}$
b Why can the value of the sine of an angle never be greater than 1?
c Why is there no limit to the value of the tangent of an angle?
- 27 1920_01_TR_04 Trigonometric Equations
Solve for values less than 360° and check:
 $\sin^2 x - \cos x = \frac{1}{4}$
- 28 1920_01_TR_05 Trigonometry: Law of Cosines
In the triangle ABC , $a = 22.531$, $b = 34.645$, $C = 43^{\circ}31'$. Find A , B , and C .
- 29 1920_01_TR_06 Polygons and Circles: Inscribed
Find the perimeter and the area of a regular decagon circumscribed about a circle whose radius is 12 units.
- 30 1920_01_TR_07 Trigonometry: Finding Sides Using Two Triangles
To find the height of an inaccessible object a horizontal base line CD , 250 feet long, is measured directly toward the foot A of the object AB ; the angles of elevation $ADB=48^{\circ}20'$, and $ACB=38^{\circ}40'$. Find the height AB .
- 31 1920_01_TR_08 Trigonometry: Law of Sines
 A and B are 1 mile apart on a straight road and C is a distant object on the same horizontal plane. The angles ABC and BAC are observed to be 120° and 45° respectively. Show (without the use of tables) that the distance from A to C is approximately 3.346 miles.
- 32 1920_01_TR_09 Solid Geometry: Spherical Polygons
In a spheric triangle $a=108^{\circ}30'$, $b=131^{\circ}35'$, $c=84^{\circ}46'$; find A , B and C .
- 33 1920_01_TR_10 Solid Geometry: Spherical Polygons
Solve the right spheric triangle ABC , given $C = 90^{\circ}$, $a = 14^{\circ}16'$, and $A = 37^{\circ}36'$.

- 34 1920_06_TR_01a Proofs: Trigonometric
If $\tan A = \frac{a}{a+1}$ and $\tan B = \frac{1}{2a+1}$ prove that $\tan(A+B) = 1$
- 35 1920_06_TR_01b Trigonometric Equations
Solve the equation $2 \cos^2 A = 1 - \sin A$ for all values of A from 0° to 360° . Check the largest angle found.
- 36 1920_06_TR_02 Proofs: Trigonometric
2 Prove the identity $\frac{\cos 2x}{1 + \sin 2x} = \frac{\cot x - 1}{\cot x + 1}$
- 37 1920_06_TR_03a Trigonometric Functions: Evaluating
Without the use of tables, find the value of $\sin 15^\circ$, leaving the answer in radical form.
- 38 1920_06_TR_03b Logarithms
By the use of logarithms find the value of
$$\frac{0.076 \times \sqrt[3]{57.46}}{(2.34)^2}$$
- 39 1920_06_TR_04 Trigonometric Functions: Evaluating
If the angle A lies between 180° and 270° and $\tan A = \frac{5}{12}$,
(a) find $\sin A$ and $\cos A$,
(b) using values found in the answer to (a) find $2A$ and $\cos \frac{A}{2}$
- 40 1920_06_TR_05a Trigonometric Identities
Show that $\frac{\sin 2A - \sin A}{\cos A - \cos 2A} = \cot \frac{3A}{2}$
- 41 1920_06_TR_05b Exponential Functions and Equations
Solve for x : $7^{2x+3} = 43$
- 42 1920_06_TR_06 Trigonometry: Law of Sines - The Ambiguous Case
In *each* of the following triangles state the number of solutions and show in full on your paper the reason for your conclusion in each case:
(1) $b=75.3$ $a=49.7$
 $A=40^\circ$
(2) $a=67.4$ $b=97.6$
 $c=30.2$
(3) $c=156.3$ $b=104.8$
 $B=142^\circ$
(4) $a=56.7$ $b=38.4$
 $A=58^\circ 20'$
(5) $a=18.0$ $c=9.0$
 $C=30^\circ$
- 43 1920_06_TR_07 Trigonometry: Finding Sides Using Two Triangles
From the top of a lighthouse 257 feet above the sea, the angles of depression to two boats, in line with the lighthouse, are observed to be 14° and 32° respectively; find the distance between the two boats.
- 44 1920_06_TR_08 Trigonometry: Law of Cosines
Given $a=71.2$, $b=64.8$, $c=37$; find all the angles of the triangle.
- 45 1920_06_TR_09 Trigonometry: Law of Sines
The longer diagonal of a parallelogram is 500 feet and the angles it makes with the sides are $46^\circ 36'$ and $10^\circ 12'$; find the lengths of the sides and the area of the parallelogram.
- 46 1920_06_TR_10 Solid Geometry: Spherical Polygons
Solve the right spheric triangle, given
 $a = 36^\circ 25' 30''$
 $b = 85^\circ 40'$
 $C = 49^\circ 50'$
- 47 1920_06_TR_11 Solid Geometry: Spherical Polygons
Solve the spheric triangle, given
 $A = 74^\circ 40'$
 $B = 67^\circ 30'$
 $C = 49^\circ 50'$

- 48 1920_06_TR_12 Solid Geometry: Spherical Polygons
A triangle on the earth's surface has its vertices respectively at the north pole, zero latitude and zero longitude, and zero latitude and 30° west longitude; considering the earth as a sphere with radius 3956 miles, find the area of this triangle.
- 49 1950_01_TR_01 Logarithms
Find the logarithm of 2.768
- 50 1950_01_TR_02 Logarithms
Find the number whose logarithm is 1.8099
- 51 1950_01_TR_03 Trigonometric Functions: Logarithms of
Find $\log \cos 24^\circ 22'$
- 52 1950_01_TR_04 Trigonometric Functions: Evaluating
Find $\tan 66^\circ 36'$
- 53 1950_01_TR_05 Circles: Radian Measure
Express in radians an angle of 140° . [Answer may be left in terms of π .]
- 54 1950_01_TR_06 Trigonometry: Reference Angles
Express $\sin 289^\circ$ as a function of a positive angle less than 45° .
- 55 1950_01_TR_07 Trigonometric Functions: Evaluating
Find the positive value of $\cot \sin^{-1} \frac{\sqrt{2}}{2}$
- 56 1950_01_TR_08 Trigonometry: Law of Cosines
In $\triangle ABC$, $a = 9$, $b = 5$, $C = 60^\circ$. Find c to the nearest integer.
- 57 1950_01_TR_09 Trigonometry: Finding Area
In $\triangle ABC$, $a = 12$, $b = 15$, $C = 150^\circ$. Find the area of $\triangle ABC$.
- 58 1950_01_TR_10 Distance
A is 200 miles N 60° W of B. C is due south of A and also due west of B. How far is A from C?
- 59 1950_01_TR_11 Trigonometric Identities: Angle Sum or Difference
If $\sin x = \frac{2}{\sqrt{5}}$ and $\cos y = \frac{3}{\sqrt{13}}$, and x and y are positive acute angles, find $\sin(x-y)$. [Answer may be left in radical form.]
- 60 1950_01_TR_12 Trigonometric Functions: Evaluating
If $\cos x = \frac{3}{5}$ and x is an acute angle, find $\tan^2 \frac{x}{2}$.
- 61 1950_01_TR_13 Trigonometric Identities: Angle Sum or Difference
In $\triangle ABC$, $a = 10$, $b = 8$, $C = 60^\circ$; find $\tan \frac{A-B}{2}$. [Answer may be left in radical form.]
- 62 1950_01_TR_14 Trigonometric Identities: Double and Half Angle
Express $\frac{2 \tan x}{\sec^2 x}$ as a single function of $2x$.
- 63 1950_01_TR_15 Trigonometric Ratios: Cofunction and Reciprocal
In $\triangle ABC$, angle A is acute. If $\sin A = \cos B$, find $\sin C$.
- 64 1950_01_TR_16 Trigonometric Equations
A root of the equation $\tan x + \cot 2x = \csc x$ is 30° . Is this statement *true* or is it *false*?
- 65 1950_01_TR_17 Trigonometric Identities
 $\sin(-A) = -\sin A$. Is this statement *true* or is it *false*?
- 66 1950_01_TR_18 Trigonometric Identities: Angle Sum or Difference
 $\sin 55^\circ - \sin 15^\circ$ equals (a) $\sin 40^\circ$ (b) $2 \cos 35^\circ \sin 20^\circ$ (c) $2 \sin 35^\circ \cos 20^\circ$
- 67 1950_01_TR_19 Trigonometric Functions: Properties of
If both $\sin x$ and $\cos x$ increase as x increases, then x must be an angle in quadrant (a) two (b) three (c) four

- 68 1950_01_TR_20 Trigonometry: Law of Sines - The Ambiguous Case
Using the data $A = 125^\circ$, $a = 50$, $b = 35$, it is possible to construct (a) only one triangle (b) two different triangles (c) no triangle
- 69 1950_01_TR_21a Proofs: Trigonometric
Prove the identity $\frac{\sin 2A}{1 + \cos 2A} = \tan A$ [5]
- 70 1950_01_TR_21b Trigonometric Equations
Find, to the *nearest degree*, the positive acute angle which satisfies the equation $\cos^2 x - \sin^2 x = \frac{7}{25}$ [5]
- 71 1950_01_TR_22 Trigonometric Formulas: Derivations of
Derive the formula for $\sin(x + y)$ where x and y are positive and $(x + y)$ is acute. [10]
- 72 1950_01_TR_23 Trigonometric Graphs
a On the same set of axes sketch the graphs of $y = \cos x$ and $y = \sin \frac{x}{2}$ as x varies from 0 to 2π radians. [3, 6]
b From the graphs made in answer to a, determine the number of values of x between 0 and 2π radians which satisfy the equation $\sin \frac{x}{2} = \cos x$ [1]
- 73 1950_01_TR_24 Medians, Altitudes, Bisectors and Midsegments
In $\triangle ABC$, the bisector of angle B meets AC in D . If AD is represented by m , show that $DC = \frac{m \sin A}{\sin C}$. [10]
- 74 1950_01_TR_25 Trigonometry: Finding Area
The sides of a triangle are 60, 28 and 40.
a Find the area of the triangle. [4]
b Using the result obtained in answer to a, find, to the *nearest integer*, the altitude on side 28. [6]
- 75 1950_01_TR_26 Trigonometry: Law of Cosines
A body is acted upon by two forces of 225 lb. and 210 lb. The angle between the lines of action of the forces is $75^\circ 40'$. Find, to the *nearest minute*, the angle formed by the lines of action of the resultant and the 210-lb. force. [3, 7]
- 76 1950_01_TR_27 Trigonometry: Finding Area
Find, to the *nearest inch*, the side of a regular pentagon whose area is 275 sq. in. [10]
- 77 1950_01_TR_28 Trigonometry: Finding Sides
A vertical tower 120 feet high stands on top of a hill that has a slope of 20° to the horizontal. From the top of the tower the angle of depression of a point on the side of the hill is 47° . Find, to the *nearest foot*, the distance, measured along the side of the hill, of this point from the foot of the tower. [4, 6]
- 78 1950_06_TR_01 Circles: Radian Measure
Express in degrees an angle of $\frac{2\pi}{9}$ radians.
- 79 1950_06_TR_02 Trigonometry: Reference Angles
Express $\cos 224^\circ$ as a function of a positive acute angle.
- 80 1950_06_TR_03 Trigonometric Equations
Find the smallest positive value of x for which $\sin^2 x = \frac{1}{2}$.
- 81 1950_06_TR_04 Trigonometric Functions: Evaluating
If x is an acute angle and $\sin x = \frac{2}{\sqrt{29}}$, find $\cot x$.
- 82 1950_06_TR_05 Trigonometric Identities: Double and Half Angle
If $\cos x = \frac{1}{9}$ and x is a positive acute angle, find $\sin \frac{1}{2} x$.

- 83 1950_06_TR_06 Trigonometric Functions: Inverses of
If $A = \cos^{-1} \frac{5}{13}$ and A is in the first quadrant, find $\cot A$.
- 84 1950_06_TR_07 Trigonometric Functions: Evaluating
Find $\sin 39^\circ 16'$.
- 85 1950_06_TR_08 Trigonometric Functions: Logarithms of
Find, to the *nearest minute*, the positive acute angle A for which $\log \cot A = 9.8306 - 10$.
- 86 1950_06_TR_09 Logarithms
Find the number whose logarithm is 3.3914.
- 87 1950_06_TR_10 Trigonometric Identities
Express $\cos 70^\circ + \cos 50^\circ$ as a function of 10° .
- 88 1950_06_TR_11 Trigonometric Identities
Express $\cos A$ in terms of $\tan A$ where A is an angle in the first quadrant.
- 89 1950_06_TR_12 Trigonometry: Law of Cosines
In triangle ABC , $a = 9$, $b = 5$, $c = 8$; find $\cos B$.
- 90 1950_06_TR_13 Trigonometry: Law of Sines
In triangle ABC , $a = 12$, $\sin A = \frac{1}{2}$, $\sin C = \frac{1}{4}$; find c .
- 91 1950_06_TR_14 Trigonometry: Law of Cosines
In triangle ABC , $a = 10$, $b = 6$, $C = 58^\circ$. Find, to the *nearest hundredth*, $\tan \frac{1}{2}(A - B)$.
- 92 1950_06_TR_15 Trigonometric Functions: Properties of
As x varies from 180° to 360° , which function of x , other than the tangent, increases throughout this interval?
- 93 1950_06_TR_16 Trigonometric Functions: Properties of
Find the maximum value of $\sin \frac{1}{2}x$.
- 94 1950_06_TR_17 Trigonometric Identities
In triangle ABC , in which $C = 90^\circ$, $\tan B = \cot A + \cos C$.
1) True
2) False
- 95 1950_06_TR_18 Trigonometric Identities
 $\sin 3A \cos A + \cos 3A \sin A = \sin 4A$.
1) True
2) False
- 96 1950_06_TR_19 Trigonometric Identities
 $\tan(-A) = \frac{\sin(-A)}{\cos A}$
1) True
2) False
- 97 1950_06_TR_20 Trigonometric Equations
One of the values of x for which $\tan(x + y)$ is equal to $\frac{1 + \tan y}{1 - \tan y}$ is 225° .
1) True
2) False
- 98 1950_06_TR_21a Proofs: Trigonometric
Prove the identity $\cos 2A = \frac{1 - \tan^2 A}{1 + \tan^2 A}$ [7]
- 99 1950_06_TR_21b Trigonometric Formulas: Derivations of
Beginning with the formula for $\tan(x + y)$, derive the formula for $\tan 2x$. [3]
- 100 1950_06_TR_22 Trigonometric Graphs
 a On the same set of axes sketch the graphs of $y = \tan x$ and $y = 2 \cos x$ from 0 to 2π radians inclusive. [3, 5]
 b From the graphs made in answer to a , determine the number of values of x between 0 and 2π radians that satisfy the equation $\tan x = 2 \cos x$. [2]
- 101 1950_06_TR_23 Trigonometric Equations
Find all values of x between 0° and 360° which satisfy the equation $2 \cos^2 \frac{1}{2}x = \sin^2 x$ [10]

- 102 1950_06_TR_24 Trigonometry: Finding Angles
Two towers whose heights are a and b (b being greater than a) stand on level ground. The angle of elevation of the top of the shorter tower from the foot of the taller tower is y and the angle of elevation of the top of the taller tower from the foot of the shorter tower is x .
- a Show that $x = \tan^{-1}\left(\frac{b \tan y}{a}\right)$ [6]
- b Find x to the nearest degree if $b = 120$, $a = 50$ and $y = 35^\circ$
- 103 1950_06_TR_25 Trigonometry: Law of Cosines
In triangle ABC , $a = 316$, $b = 227$ and $C = 76^\circ 20'$. Find A to the nearest minute. [10]
- 104 1950_06_TR_26 Trigonometry: Law of Cosines
In a certain air race, the course was a triangle with sides 155 miles, 212 miles and 307 miles. Find, to the nearest degree, the angle at the turn between the 155-mile and 307-mile sides. [10]
- 105 1950_06_TR_27 Trigonometry: Finding Sides Using Two Triangles
Two lighthouses, A and B , are each directly north of a ship, A being the lighthouse nearer the ship. After the ship has proceeded 28 miles on a course $N 55^\circ E$, A bears directly west and B , $N 40^\circ W$. Find, to the nearest mile, the distance between A and B . [5, 5]
- 106 1950_06_TR_28 Triangles: Vectors
Two forces are to act on a body to produce a resultant of 74 pounds. If the lines of action of the two forces form an angle of 65° and one of the forces is 45 pounds, find, to the nearest pound, the other force. [4, 6]
- 107 1950_08_TR_01 Logarithms
Find the logarithm of 3.064
- 108 1950_08_TR_02 Logarithms
Find the number whose logarithm is 9.8914 - 10
- 109 1950_08_TR_03 Trigonometric Functions: Logarithms of
Find $\log \tan 72^\circ 13'$
- 110 1950_08_TR_04 Trigonometry: Finding Angles
If $\cos A = 0.7946$, find acute angle A to the nearest minute.
- 111 1950_08_TR_05 Trigonometry: Reference Angles
Express $\sec(-130^\circ)$ as a function of a positive acute angle.
- 112 1950_08_TR_06 Circles: Radian Measure
Express 40° to the nearest tenth of a radian.
- 113 1950_08_TR_07 Trigonometric Functions: Inverses of
Express as a common fraction the positive value of $\cos\left(\sin^{-1}\frac{\sqrt{5}}{3}\right)$
- 114 1950_08_TR_08 Trigonometric Identities
If A is a positive acute angle, express $\cot A$ in terms of $\sin A$.
- 115 1950_08_TR_09 Trigonometry: Law of Cosines
In $\triangle ABC$, $a = 2$, $b = 4$, $c = 3$. Find $\cos B$.
- 116 1950_08_TR_10 Trigonometry: Law of Sines
In $\triangle ABC$, $A = 45^\circ$, and $B = 105^\circ$. Find the numerical value of $\frac{a}{c}$. [Answer may be left in radical form.]
- 117 1950_08_TR_11 Trigonometric Functions: Evaluating
In $\triangle ABC$, $a = 3$, $b = 2$, and $\tan\frac{A-B}{2} = 2$. Find the value of $\tan\frac{A+B}{2} = 2$.
- 118 1950_08_TR_12 Trigonometric Identities
If $\cos A = m$, express $\sin^2\frac{A}{2}$ in terms of m .
- 119 1950_08_TR_13 Trigonometric Identities: Angle Sum or Difference
Express $\tan(A+B)$ in terms of $\tan A$ and $\tan B$.

- 120 1950_08_TR_14 Trigonometric Identities: Angle Sum or Difference
If $\sin x = \frac{3}{5}$ and $\cos y = \frac{5}{13}$, and x and y are first quadrant angles, find $\cos(x + y)$.
- 121 1950_08_TR_15 Trigonometry: Finding Area
Sides 5 and 12 of a parallelogram include an angle of 150° . Find the area of the parallelogram.
- 122 1950_08_TR_16 Solid Geometry: Spherical Polygons
A ship, now at a certain position, must sail 120 miles in a direction $S 31^\circ E$ in order to make port. Find, to the *nearest mile*, how far west of its port the ship is now.
- 123 1950_08_TR_17 Trigonometric Identities: Double and Half Angle
Express $\sin 70^\circ - \sin 10^\circ$ as a function of 40° .
- 124 1950_08_TR_18 Trigonometry: Law of Sines - The Ambiguous Case
Using the data $A = 28^\circ$, $a = 12$, $b = 18$, it is possible to construct (a) only one triangle (b) two different triangles (c) no triangle 18.
- 125 1950_08_TR_19 Trigonometric Functions: Properties of
As angle x increases from $\frac{\pi}{2}$ to π , $\cos x$ (a) increases from -1 to 0 (b) decreases from 1 to 0 (c) decreases from 0 to -1.
- 126 1950_08_TR_20 Trigonometric Graphs
When drawn on the same set of axes, the graph of $y = 2$ will never intersect the graph of (a) $y = 3 \sin x$, (b) $y = \sin 3x$ (c) $y = \tan x$
- 127 1950_08_TR_21a Proofs: Trigonometric
Prove the identity: $\frac{\sin 2A}{\sin A} = \frac{\cos 2A + 1}{\cos A}$ [5]
- 128 1950_08_TR_21b Trigonometric Equations
Solve for the positive value of x less than 360°
 $1 + 2 \csc x = \sin x$ [5]

- 129 1950_08_TR_22 Trigonometric Graphs
a On the same set of axes, sketch the graphs of $y = \sin x$ and $y = 2 \cos x$ as x varies from 0 to 27π radians. [3, 5]
b From the graphs made in answer to a, determine the quadrants in which can be found the values of x satisfying the equation: $\sin x = 2 \cos x$ [2]

- 130 1950_08_TR_23 Trigonometry: Law of Cosines
Derive the law of cosines for the case in which the triangle is acute. [10]

- 131 1950_08_TR_24 Proofs: Trigonometric
In the figure at the right, $\angle C = 90^\circ$, $\angle DAC$ is x and $\angle BAD$ is $2x$. Show that $DB = 2AB \sin x$. [10]

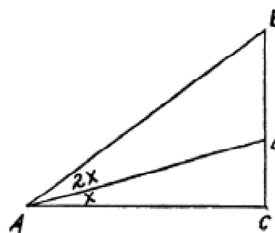

- 132 1950_08_TR_25 Trigonometry: Law of Cosines
In $\triangle ABC$, $a = 28.4$, $b = 32.5$, $c = 36.3$. Find C to the *nearest minute*. [10]
- 133 1950_08_TR_26 Trigonometry: Law of Sines
In order to find the distance across a river, a surveyor uses points A and B along the bank of the river and a point C on the opposite bank. He finds angle CAB to be $62^\circ 10'$, angle ABC to be $40^\circ 30'$ and AB to be 275 feet. Find, to the *nearest foot*, the width of the river. [3, 7]
- 134 1950_08_TR_27 Trigonometry: Law of Sines
Starting from a position A , a ship sails a certain distance in the direction $S 70^\circ 20' E$ from A , until it reaches a position B . It then takes the direction $N 37^\circ 10' E$ from B and sails 194 miles to its destination C . If C is $N 65^\circ 50' E$ of A , find AC to the *nearest mile*. [6, 4]
- 135 1950_08_TR_28 Trigonometry: Law of Cosines
In $\triangle ABC$, $A = 57^\circ 40'$, $b = 93.7$ and $c = 72.3$. Find B to the *nearest minute*. [10]

- 136 1960_01_TR_01 Trigonometry: Reference Angles
Express $\tan(-310^\circ)$ as a function of a positive acute angle.
- 137 1960_01_TR_02 Circles: Center, Radius and Circumference
In a circle, a central angle of 2.5 radians intercepts an arc of 15 inches. Find the number of inches in the radius of the circle.
- 138 1960_01_TR_03 Circles: Radian Measure
Express in degrees an angle of 2 radians.
- 139 1960_01_TR_04 Trigonometric Identities
If A is a positive acute angle, express $\cot A$ in terms of $\sec A$.
- 140 1960_01_TR_05 Trigonometry: Law of Sines
In $\triangle ABC$, $A = 30^\circ$, $C = 105^\circ$ and $b = 6$. Find a .
- 141 1960_01_TR_06 Trigonometry: Law of Cosines
In $\triangle ABC$, $A = 60^\circ$, $b = 5$, and $c = 8$. Find a .
- 142 1960_01_TR_07 Trigonometric Functions: Evaluating
Find the positive value of $\sin(\arctan \frac{1}{3})$.
- 143 1960_01_TR_08 Trigonometric Functions: Logarithms of
Find $\log \tan 37^\circ 17'$.
- 144 1960_01_TR_09 Trigonometric Functions: Inverses of
Find to the *nearest minute* the positive acute angle A if $\cos A = 0.7720$.
- 145 1960_01_TR_10 Trigonometric Identities: Double and Half Angle
If $\tan A = \frac{1}{2}$, find $\tan 2A$.
- 146 1960_01_TR_11 Trigonometric Identities: Angle Sum or Difference
Express $\cos 52^\circ + \cos 32^\circ$ as a product of two functions.
- 147 1960_01_TR_12 Trigonometric Functions: Properties of
As angle θ increases from 180° to 360° , $\sin \theta$
(1) increases throughout the interval
(2) decreases throughout the interval
(3) decreases, then increases
(4) increases, then decreases
Which is correct: 1, 2, 3, or 4?
- 148 1960_01_TR_13 Trigonometric Functions: Evaluating
Find the value of the acute angle θ for which the following is true:
 $2 \cos^2 \theta - \sqrt{3} \cos \theta = 0$
- 149 1960_01_TR_14 Trigonometric Functions: Evaluating
What is the minimum value of $\cos 3x$?
- 150 1960_01_TR_15 Trigonometry: Law of Sines - The Ambiguous Case
How many triangles can be constructed using the data $A = 95^\circ$, $b = 9$, and $a = 8$?
- 151 1960_01_TR_16 Trigonometry: Finding Area
In parallelogram $ABCD$, $AB = 10$, $AD = 6$ and angle $A = 44^\circ 40'$. Find to the *nearest integer* the area of the parallelogram.
- 152 1960_01_TR_17 Trigonometric Identities
Directions: Indicate whether the following statement is true for
 a all real values of x
 b some but not all real values of x
 c no real value of x
by writing on the line at the right the letter a , b or c .
 $\sin^2 x = 2 - \cos^2 x$
- 153 1960_01_TR_18 Trigonometric Identities
Directions: Indicate whether the following statement is true for
 a all real values of x
 b some but not all real values of x
 c no real value of x
by writing on the line at the right the letter a , b or c .
 $\sin(90^\circ + x) = \cos x$

- 154 1960_01_TR_19 Trigonometric Identities
Directions: Indicate whether the following statement is true for
 a all real values of x
 b some but not all real values of x
 c no real value of x
 by writing on the line at the right the letter a , b or c .
 $\sin x + \cos x = 1$
- 155 1960_01_TR_20 Trigonometric Identities
Directions: Indicate whether the following statement is true for
 a all real values of x
 b some but not all real values of x
 c no real value of x
 by writing on the line at the right the letter a , b or c .
 $\cos 6x = 2 \cos^2 3x - 1$
- 156 1960_01_TR_21 Trigonometric Equations
 Find all values of x between 0° and 360° which satisfy the equation $2 \sin x + 4 \cos 2x = 3$. [Express approximate values of x to the *nearest degree*.] [10]
- 157 1960_01_TR_22 Trigonometric Graphs
 a On the same set of axes, *sketch* the graphs of $y = 2 \sin \frac{1}{2}x$ and $y = \frac{1}{2} \cos x$ as x varies from 0 to 2π radians. [4, 4]
 b From the graphs made in answer to part a , determine the quadrants in which x lies if $2 \sin \frac{1}{2}x = \frac{1}{2} \cos x$. [2]
- 158 1960_01_TR_23 Trigonometric Formulas: Derivations of
 a Starting with a formula for $\cos 2A$, *derive* the formula for $\cos \frac{x}{2}$ in terms of $\cos x$. [5]
 b Starting with the formula for $\sin(x - y)$ and $\cos(x - y)$, *derive* the formula for $\tan(x - y)$ in terms of $\tan x$ and $\tan y$. [5]
- 159 1960_01_TR_24 Proofs: Trigonometric
 a Prove that the following equality is an identity: [5]

$$\tan x = \frac{\sin 2x}{1 + \cos 2x}$$

 b Show that $\sin(45^\circ + x) + \sin(45^\circ - x)$ may be reduced to $\sqrt{2} \cos x$. [5]
- 160 1960_01_TR_25 Trigonometric Identities
 Given acute triangle ABC . Show that

$$\tan B = \frac{b \sin A}{c - b \cos A}$$

 [Hint: Draw the altitude from C .] [10]
- 161 1960_01_TR_26 Trigonometry: Law of Cosines
 In $\triangle ABC$, $a = 37.6$, $b = 26.4$ and $C = 70^\circ 20'$. Find A to the *nearest ten minutes*. [10]
- 162 1960_01_TR_27 Triangles: Vectors
 Two forces acting upon a body make an angle of $103^\circ 30'$ with each other. The magnitude of the first force is 386 pounds. If the resultant makes an angle of $47^\circ 10'$ with the first force, what is the magnitude of the resultant, to the *nearest pound*? [10]
- 163 1960_01_TR_28 Trigonometry: Law of Cosines
 Two ships leave point A at 10:30 a.m. One travels in a direction of 049° (N 49° E) at 12 miles per hour and the other travels in a direction of 135° (S 45° E) at 14 miles per hour. How far apart, to the *nearest mile*, will they be at noon? [5,5]
- 164 1960_01_TR_29 Trigonometry: Finding Angles
 In $\triangle ABC$, $AB = 28.7$, $BC = 36.4$ and $CA = 14.3$. Find B to the *nearest ten minutes*. [10]
- 165 1960_06_TR_01 Trigonometric Functions: Evaluating
 Find the numerical value of $\cos \frac{\pi}{3}$.
- 166 1960_06_TR_02 Circles: Radian Measure
 Find the number of inches in the radius of a circle in which a central angle of $1\frac{1}{2}$ radians subtends an arc of 6 inches.

- 167 1960_06_TR_03 Trigonometric Equations
Find in degrees the smallest positive value of A which satisfies the equation $4 \sin^2 A - 1 = 0$.
- 168 1960_06_TR_04 Trigonometric Functions: Inverses of
If $7 \tan A - 3 = 0$, express A in inverse trigonometric form.
- 169 1960_06_TR_05 Logarithms
Find the antilogarithm of 1.3799.
- 170 1960_06_TR_06 Trigonometric Functions: Logarithms of
Find $\log \tan 36^\circ 28'$.
- 171 1960_06_TR_07 Trigonometric Functions: Evaluating
Find $\cos 75^\circ 34'$.
- 172 1960_06_TR_08 Trigonometry: Finding Sides
 A is 100 miles N 42° E of B . C is due north of B and due west of A . Find to the *nearest mile* the distance from B to C .
- 173 1960_06_TR_09 Trigonometry: Finding Area
In triangle ABC , $a = 8$, $c = 5$ and $B = 20^\circ$. Find to the *nearest integer* the area of triangle ABC .
- 174 1960_06_TR_10 Trigonometry: Law of Cosines
In triangle ABC , $b = 12$, $c = 6$ and $A = 100^\circ$. Find to the *nearest hundredth* the value of $\tan \frac{1}{2}(B - C)$.
- 175 1960_06_TR_11 Trigonometry: Law of Cosines
In triangle ABC , $a = 6$, $b = 7$ and $\cos C = \frac{1}{4}$. Find c .
- 176 1960_06_TR_12 Trigonometry: Law of Sines
In triangle ABC , $a = 15$, $b = 6$ and $A = 30^\circ$. Find $\sin B$.
- 177 1960_06_TR_13 Trigonometric Identities
Express $\cos(x - y)$ in terms of the sine and cosine of x and y .
- 178 1960_06_TR_14 Trigonometric Identities
If A is a positive acute angle, express $\cos A$ in terms of $\cot A$.
- 179 1960_06_TR_15 Trigonometric Identities: Double and Half Angle
If x is an acute angle and $\cos x = m$, express $\cos \frac{x}{2}$ in terms of m .
- 180 1960_06_TR_16 Circles: Radian Measure
Express 160° in radian measure.
- 181 1960_06_TR_17 Trigonometric Equations
Find in degrees the acute angle x if $\sin x = \cos(3x - 10^\circ)$.
- 182 1960_06_TR_18 Trigonometric Identities
Express $\cos \theta \cot \theta$ in terms of $\sin \theta$.
- 183 1960_06_TR_19 Trigonometric Functions: Logarithms of
Express $\log \tan A$ in terms of $\log \sin A$ and $\log \cos A$.
- 184 1960_06_TR_20 Trigonometric Identities: Angle Sum or Difference
Given $\sec 50^\circ = a$, express 130° in terms of a .
- 185 1960_06_TR_21 Trigonometric Identities
The expression $\tan(45^\circ + x)$ is equal to
(1) $\frac{1 + \tan x}{1 - \tan x}$ (2) $\frac{1 - \tan x}{1 + \tan x}$ (3) $1 + \tan x$ (4) $1 - \tan x$
- 186 1960_06_TR_22 Trigonometric Functions: Evaluating
The minimum value of $2 \cos 3x$ is
(1) -1 (2) 2 (3) -6 (4) -2
- 187 1960_06_TR_23 Trigonometric Identities
The expression $\cos 3x + \cos x$ is equal to
(1) $\cos 4x$ (2) $2 \cos 2x \sin x$ (3) $2 \cos 2x \cos x$ (4) $-2 \sin 2x \sin x$

188 1960_06_TR_24 Trigonometric Identities
For all values of x , $\cos(-x) + \sin(-x)$ is equal to

- (1) $\cos x + \sin x$ (2) $-\cos x + \sin x$ (3)
 $-\cos x - \sin x$ (4) $\cos x - \sin x$

189 1960_06_TR_25 Trigonometric Functions: Properties of

If both $\sin x$ and $\cos x$ increase as x increases, then x must be an angle in quadrant

- (1) one (2) two (3) three (4)
four

190 1960_06_TR_26

The graph of the function $y = 2 \cos \frac{1}{2}x$ passes through the point whose coordinates are

- (1) $(\pi, 2)$ (2) $(2\pi, 2)$ (3) $(\pi, -2)$ (4)
 $(2\pi, -2)$

191 1960_06_TR_27 Trigonometry: Law of Sines - The Ambiguous Case

Using the data $A = 40^\circ$, $a = 13$ and $b = 20$,

- (1) triangle ABC must be acute
(2) triangle ABC must be obtuse
(3) triangle ABC must be either acute or obtuse
(4) no triangle can be constructed

192 1960_06_TR_28 Trigonometric Identities

For all values of x , $\sin(270^\circ + x)$ is equal to

- (1) $-\sin x$ (2) $-\cos x$ (3)
 $\cos x$ (4) $-\csc x$

193 1960_06_TR_29 Trigonometric Identities

The equation $\cos 2x + 1 = 2 \cos^2 x$ is true for

- (1) all value of x (2) some but not all values
of x (3) no value of x

194 1960_06_TR_30 Trigonometric Functions: Properties of
The statement $\sin 2x > 2 \sin x$ is true for

- (1) all values of x in quadrant I
(2) some, but not all, values of x in quadrant I
(3) no value of x in quadrant I

195 1960_06_TR_31 Trigonometric Equations

Find *all* values of A between 0° and 360° that satisfy the equation

$$2 \cos 2A - 3 \sin A - 1 = 0.$$

[Express approximate values of A to the *nearest degree*.] [10]

196 1960_06_TR_32 Trigonometric Formulas: Derivations of

a Starting with the formula for $\sin(x - y)$ and $\cos(x - y)$, *derive* the formula for $\tan(x - y)$. [6]

b Show that the expression $\frac{\sec x}{\cot x + \tan x}$ can be reduced to $\sin x$. [4]

197 1960_06_TR_33 Trigonometric Graphs

a On the same set of axes, *sketch* the graphs of $y = \sin \frac{1}{2}x$ and $y = 2 \cos x$ as x varies from 0 to 2π radians. [Label each curve with its equation.] [4,4]

b From the graphs made in answer to *a*, find the number of values of x greater than 0 and less than 2π , for which $2 \cos x - \sin \frac{1}{2}x = 0$. [2]

198 1960_06_TR_34 Trigonometry: Finding Sides Using Two Triangles

Given right triangle ABC , hypotenuse AB , D any point on AC and line BD drawn. *Derive* a formula for BC in terms of AD , angle x and angle y . [10]

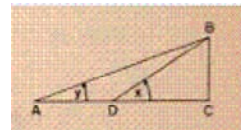

- 199 1960_06_TR_35 Trigonometry: Finding Sides
The captain of a ship sights a lighthouse bearing 040° (N 40° E). After sailing on a course 335° (N 25° W) for a distance of 5.5 miles, he then finds the bearings of the lighthouse is 075° (N 75° E). Find to the *nearest tenth of a mile* the distance of the ship from the lighthouse at the time the second bearing was taken. [6,4]
- 200 1960_06_TR_36 Trigonometry: Law of Cosines
Answer either a or b :
- a In triangle ABC , $a = 19.5$, $b = 28.7$ and $c = 17.6$. Find to the *nearest degree* the smallest angle of triangle ABC . [10]
- b Two forces of 70 pounds and 125 pounds act on a body at an angle of 68° with each other. Find to the *nearest ten minutes* the angle formed by the lines of action of the resultant and the larger force. [10]
- 201 1960_08_TR_01 Trigonometry: Reference Angles
Express $\sec 100^\circ$ as a function of a positive acute angle.
- 202 1960_08_TR_02 Trigonometric Functions: Evaluating
Find the numerical value of $\sin \frac{\pi}{6} + \cos 2\pi$.
- 203 1960_08_TR_03 Trigonometric Functions: Inverses of
Find to the *nearest minute* the positive acute angle whose sine is 0.3808.
- 204 1960_08_TR_04 Trigonometric Functions: Logarithms of
Find $\log \cos 60^\circ 32'$.
- 205 1960_08_TR_05 Trigonometric Equations
Find the number of degrees in an acute angle that satisfies the equation $\sin B = \cos 2B$.
- 206 1960_08_TR_06 Trigonometric Identities
Express $\frac{\tan A}{\sec A}$ in terms of $\sin A$.
- 207 1960_08_TR_07 Trigonometry: Terminal Sides of Angles
An angle in standard position has its terminal side passing through the point $(0, -2)$. Find the value of the cosine of this angle.
- 208 1960_08_TR_08 Trigonometry: Law of Cosines
In triangle ABC , $b = 10$, $c = 12$ and $\cos A = 0.20$. Find a .
- 209 1960_08_TR_09 Trigonometry: Law of Sines
In triangle ABC , $a = 30$, $\sin A = 0.81$ and $\sin B = 0.31$. Find to the *nearest integer* the length of side b .
- 210 1960_08_TR_10 Circles: Radian Measure
Find the number of inches in the radius of a circle in which a central angle of 2 radians intercepts an arc of 16 inches.
- 211 1960_08_TR_11 Trigonometric Functions: Evaluating
Find the positive value of $\sin(\arccos x)$.
- 212 1960_08_TR_12 Trigonometric Functions: Evaluating
If $\cos 2\theta$ is represented by x , express $\sin^2 \theta$ in terms of x .
- 213 1960_08_TR_13 Trigonometric Functions: Evaluating
If $\tan \theta = \frac{1}{2}$, find the numerical value of $\tan 2\theta$.
- 214 1960_08_TR_14 Trigonometric Functions: Evaluating
If $\tan \theta$ is represented by x , express $\sec^2 \theta$ in terms of x .
- 215 1960_08_TR_15 Circles: Radian Measure
Find to the *nearest degree* the number of degrees in an angle of 1.5 radians.
- 216 1960_08_TR_16 Trigonometric Identities: Double and Half Angle
If $\cos x = \frac{7}{25}$, find the positive value of $\cos \frac{1}{2}x$.

- 217 1960_08_TR_17 Trigonometric Functions: Evaluating
If A is a quadrant I angle whose cosine is $\frac{4}{5}$ and B is a quadrant II angle whose cosine is $-\frac{4}{5}$, find the value of $\sin(A + B)$.
- 218 1960_08_TR_18 Trigonometric Identities: Angle Sum or Difference
Express $\cos 100^\circ + \cos 50^\circ$ as an equivalent product of trigonometric functions.
- 219 1960_08_TR_19 Trigonometry: Finding Area
In triangle ABC , $a = 10$, $C = 60^\circ$ and the area of the triangle $= 40\sqrt{3}$. Find b .
- 220 1960_08_TR_20 Trigonometric Identities
Simplify: $\frac{\cos(90^\circ + A)}{\sin(-A)}$
- 221 1960_08_TR_21 Trigonometric Identities
For all values of A , $\cos(-A)$ equals
(1) $\sin A$ (2) $-\sin A$ (3) $\cos A$ (4) $-\cos A$
- 222 1960_08_TR_22 Trigonometric Graphs
The period of the function $\frac{1}{2} \sin 2x$ is
(1) 1 (2) $\frac{1}{2}$ (3) π (4) 2π
- 223 1960_08_TR_23 Trigonometric Identities
The expression $\frac{1}{1 - \sin x} + \frac{1}{1 + \sin x}$ is equivalent to
(1) 1 (2) $2 \sec^2 x$ (3) $2 \cos^2 x$ (4) $\frac{2}{\cos^2 x - 1}$
- 224 1960_08_TR_24 Trigonometric Functions: Evaluating
If $y = 2 \sin x$, a value of x which gives a maximum value for y is
(1) 45° (2) 90° (3) 180° (4) 270°
- 225 1960_08_TR_25 Trigonometric Functions: Evaluating
In triangle ABC , $A = 105^\circ$ and $B = 15^\circ$. The ratio $\frac{a-b}{a+b}$ is
(1) $1 : \sqrt{2}$ (2) $1 : \sqrt{3}$ (3) $\sqrt{3} : 1$ (4) $3 : 4$
- 226 1960_08_TR_26 Trigonometric Equations
The set of all positive values of x less than 360° which satisfies the equation $(2 \cos x - 1)(\cos x + 1) = 0$ consists of three members. Two of these are 60° and 180° . The remaining one is
(1) 120° (2) 210° (3) 240° (4) 300°
- 227 1960_08_TR_27 Trigonometric Graphs
As x increases from 0° to 360° , the number of times the graphs of $y = \sin x$ and $y = \cos x$ intersect is
(1) 1 (2) 2 (3) 3 (4) 4
- 228 1960_08_TR_28 Trigonometric Ratios: Basic
In triangle ABC , $C = 90^\circ$. If $\tan A$ is represented by x and side AC is represented by $3x$, side CB equals
(1) $3x$ (2) $3x^2$ (3) 3 (4) $\frac{1}{3}$
- 229 1960_08_TR_29 Trigonometric Functions: Logarithms of
If $\log \sin A = \log a - \log c$, then a equals
(1) $c \sin A$ (2) $\log c \sin A$ (3) $(\log c)(\log \sin A)$ (4) $c + \sin A$
- 230 1960_08_TR_30 Trigonometry: Law of Sines - The Ambiguous Case
Using the data $A = 30^\circ$, $a = 10$ and $b = 20$,
(1) one isosceles triangle can be constructed
(2) one acute triangle and one obtuse triangle can be constructed
(3) one right triangle can be constructed
(4) no triangle can be constructed

- 231 1960_08_TR_31 Trigonometry: Law of Sines
 Two angles of a triangle are $142^\circ 10'$ and $24^\circ 30'$.
 The longest side of the triangle is 962 centimeters.
 Find, to the *nearest centimeter*, the length of the
shortest side of the triangle. [10]

- 232 1960_08_TR_32 Proofs: Trigonometric
 Prove the identities:
 a $(1 + \cos x)(\csc x - \cot x) = \sin x$ [5]
 b $\frac{\sin 2A}{1 + \cos 2A} = \tan A$ [5]

- 233 1960_08_TR_33 Trigonometric Formulas: Derivations of
 a Starting with the formula for $\cos(x + y)$,
derive the formula for $\cos 2x$ in terms of $\sin x$. [5]
 b In the accompanying diagram $CB \perp AB$ and
 $CD \perp BD$. Using the letters as shown on the
 diagram, *derive* the relationship $d = c \tan x \sin y$. [5]

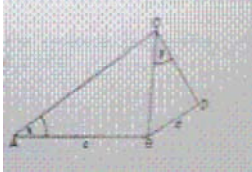

- 234 1960_08_TR_34 Trigonometric Equations
 Find all positive values of A less than 360° which
 satisfy the equation
 $\sin^2 A + 1 = \cos A (1 + 2 \cos A)$.
 [Express approximate values to the *nearest degree*.]
 [10]

- 235 1960_08_TR_35 Trigonometric Graphs
 a On the same set of axes *sketch* the graphs
 of $y = 2 \sin x$ and $y = \cos 2x$ as x varies from $-\pi$ to
 π . [4, 4]
 b State the minimum value of the function
 $\cos 2x$. [2]

- 236 1960_08_TR_36 Trigonometry: Finding Area
 The diagonals of a parallelogram are 18 and 30, and
 they intersect at an angle of 60° .
 a Find the area of the parallelogram. [5]
 b Find the length of a longer side. [5]
 [Answers may be left in radical form.]

TWA and TWB - The Twelfth Year Curricula (1960)

- 1 1960_01_TWA_01 Numbers: Complex

Express $\frac{5}{2-i}$ in the form of $a + bi$.

- 2 1960_01_TWA_02 Parallel and Perpendicular Lines

Write an equation of the line that passes through the point (3, -2) and that is parallel to the line whose equation is $2x - 3y = 4$.

- 3 1960_01_TWA_03 Quadratics: Using the Discriminant

For what value of k will the graph of $y = x^2 - 8x + k$ be tangent to the x -axis?

- 4 1960_01_TWA_04 Binomial Expansions

Write in simplest form the fourth term *only* in the expansion of

$$\left(x^2 + \frac{2}{x}\right)^6$$

- 5 1960_01_TWA_05 Polynomials: Multiplication and Division of

Find the remainder when $3x^9 + 2x^6 - 3$ is divided by $x + 1$.

- 6 1960_01_TWA_06 Exponential Functions and Equations

Solve for x : $4^x = \frac{1}{8}$

- 7 1960_01_TWA_07 Exponential Functions and Equations

Find the real root of the equation $x^{\frac{3}{2}} = \frac{8}{27}$

- 8 1960_01_TWA_08 Equations: Logarithmic

Find the x -intercept of the graph of $y = \log_5 x$

- 9 1960_01_TWA_09 Radicals: N-Roots

Find to the *nearest hundredth* the value of $\sqrt[3]{0.257}$

- 10 1960_01_TWA_10 Fractions: Complex

Express in simplest form $\frac{1 + \frac{2}{a-2}}{1 - \frac{a-5}{a-2}}$

- 11 1960_01_TWA_11 Equations: Roots of Higher Order

Two of the roots of the equation $2x^3 - 3x^2 + px + q = 0$ are 3 and -2. Find the third root.

- 12 1960_01_TWA_12 Equations and Expressions: Using Substitution in

If $f(x) = x^2 + 4x$, express $f(a-2)$ as a product of two binomials.

- 13 1960_01_TWA_13 Exponents

Find the value of $3x^6 + \left(\frac{4}{x}\right)^{-3} + \sqrt[3]{x^2}$ if $x = 8$.

- 14 1960_01_TWA_14 Equations and Expressions: Using Substitution in

If $f(x)$ is identically equal to $(x-8)Q(x) + 7$, find the numerical value of $f(8)$.

- 15 1960_01_TWA_15 Quadratics: Solving

Solve for x : $a^2 = \frac{1-x}{1+x}$

- 16 1960_01_TWA_16 Combinatorics: Multiplication Counting Principle

An algebra examination contains 8 questions. Each student is to answer the first question and any 4 others. How many different selections of 5 questions may be made?

- 17 1960_01_TWA_17 Combinatorics: Multiplication Counting Principle

How many *odd* numbers of 3 digits each can be written with the digits 1, 2, 3, 4, 5 if no digits are to be repeated?

- 18 1960_01_TWA_18 Probability: Dependent Events
A bag contains 3 black balls and 4 white balls. If 2 balls are drawn from the bag, what is the probability that both will be black?
- 19 1960_01_TWA_19 Variation: Inverse
Using k as a constant of variation, write an equation that represents the relationship: x varies directly as y and inversely as the square of z .
- 20 1960_01_TWA_20 Slope
The slope of the line that passes through the points $(-2, 3)$ and $(5, y)$ is $-\frac{4}{7}$. Find the value of y .
- 21 1960_01_TWA_21 Conversions
Express the repeating decimal $0.636363 \dots$ as a common fraction.
- 22 1960_01_TWA_22 Systems: Other Nonlinear
If the graphs of $4x^2 = y^2 = 16$ and $y = 2x^2 - 2$ are drawn on the same set of axes, the number of points they will have in common is
(1) 1 (2) 2 (3) 3 (4) 4
- 23 1960_01_TWA_23 Quadratics: Axis of Symmetry
The equation of the axis of symmetry of the parabola $y = ax^2 - 4x + 1$ is $x = 1$. The value of a is
(1) -2 (2) +2 (3) -4 (4) +4
- 24 1960_01_TWA_24 Radicals: Solving
The equation $\sqrt{x+6} - x = 0$ has
(1) no root (2) -2 as its only root (3) 3 as its only root (4) the two roots 3 and -2
- 25 1960_01_TWA_25 Rate
One machine can complete a job in p minutes and a second machine can do the job in q minutes. If both machines work together, the time in minutes required to complete the job is
(1) $\frac{pq}{p+q}$ (2) $\frac{p+q}{2}$ (3) $\frac{p+q}{pq}$ (4) $p+q$
- 26 1960_01_TWA_26 Inequalities: Linear
Solve the inequality $x + 8 < 4x - 1$
- 27 1960_01_TWA_27 Parallel and Perpendicular Lines
Write an equation of the line that passes through the point $(0,3)$ and is perpendicular to the line whose equation is $y = 2x - 1$.
- 28 1960_01_TWA_28 Circles: Equations of
Find the radius of the circle whose equation is $x^2 - 6x + y^2 + 2y - 6 = 0$
- 29 1960_01_TWA_29 Equations: Roots of Higher Order
Find the rational root of $3x^3 + 7x^2 + 8x + 2 = 0$
- 30 1960_01_TWA_30 Equations: Roots of Higher Order
Between what two consecutive integers does the positive root of the equation $x^3 + 3x - 20 = 0$ lie?
- 31 1960_01_TWA_31 Equations: Roots of Higher Order
A positive root of the equation $x^3 + 3x^2 + 8x - 4 = 0$ lies between 0.4 and 0.5 . Find this root to the nearest tenth.
- 32 1960_01_TWA_32 Equations: Roots of Higher Order
Find all the roots of the equation $x^4 + 8x^2 - 9 = 0$
- 33 1960_01_TWA_33 Equations: Literal
If $y = x^2 - 3x$, express x in terms of y .
- 34 1960_01_TWA_34 Calculus: Integral
[Write the *number* preceding the correct answer in the space provided.]
Which one of the following is a rational integral function in x ?
(1) $2x^2 - \sqrt{x} - 1$ (2)
 $\frac{2}{3}x^2 - x\sqrt{3} - 5$
(3) $x^2 - \frac{3}{x} - 5$ (4)
 $x^{\frac{2}{3}} - x - 5$

- 35 1960_01_TWA_35 Quadratics: Find Vertex Given Equation
An arrow is shot vertically upward. Its height h in feet after t seconds is given by the formula $h = 128t - 16t^2$. After how many seconds will it reach its maximum height?
- 36 1960_01_TWA_36 Calculus: Differential
Find the abscissa of the point of inflection of the graph of $y = x^3 - 3x^2 - 9x + 2$
- 37 1960_01_TWA_37 Calculus: Differential
Find the slope of the line tangent to the graph of $y = x^2 - 3x - 1$ at the point $(4, 3)$.
- 38 1960_01_TWA_38 Trigonometric Expressions: Factoring
Multiply $2(\cos 30^\circ + i \sin 30^\circ)$ by $3(\cos 10^\circ + i \sin 10^\circ)$.
- 39 1960_01_TWA_39 Trigonometry: Polar Coordinates
Transform $xy = 6$ from rectangular to polar coordinates.
*This question is based upon one of the optional topics in the syllabus.
- 40 1960_01_TWA_40 Trigonometry: Polar Coordinates
Transform $r^2 + 2r \sin \theta = 8$ from polar coordinates to rectangular coordinates.
*This question is based upon one of the optional topics in the syllabus.
- 41 1960_01_TWA_41 Progressions: Arithmetic
The first three terms of an arithmetic progression are x , $(2x + 1)$ and $(5x - 4)$. Find the value of x .
- 42 1960_01_TWA_42 Logarithms
Find $\log_4 15.4$ to the nearest tenth.
- 43 1960_01_TWA_43 Exponents
Find to the nearest tenth the value of $(26.3)^{1.4}$
- 44 1960_01_TWA_44 Equations: Logarithmic
If $y = 3^x$ and $x = \log_a y$, find the value of a .
- 45 1960_01_TWA_45 Logarithms
If $a^x = b^{x+1}$, express x in terms of the logarithms of a and b .
- 46 1960_01_TWA_46 Slope
The graphs of $y = mx - 1$ and $(x - 2)^2 + (y + 3)^2 = 25$ are drawn on the same set of axes. If the graph of the straight line passes through the center of the circle, find the value of m .
- 47 1960_01_TWA_47 Probability: Mutually Exclusive Events
[Write the *number* preceding the correct answer in the space provided.]
The probability that Tom will hit a target is $\frac{3}{5}$. The probability that tom will *not* hit the target is
(1) $\frac{5}{8}$ (2) $\frac{5}{3}$ (3) $\frac{2}{5}$ (4) $\frac{3}{8}$
- 48 1960_01_TWA_48 Rate, Time and Distance
A man went on a trip of m miles traveling by a train whose average speed was r miles per hour. He returned by a plane whose average speed was three times that of the train. If the return trip was also a distance of m miles and the total traveling time for the round trip was 8 hours, express m in terms of r .
- 49 1960_01_TWA_49 Systems: Writing
A man engages in a shooting contest. Each time he hits the target, he receives 10 cents and each time he misses, he pays 5 cents. If after 20 shots the man has lost 10 cents, how many times did he hit the target?
- 50 1960_01_TWA_50 Trigonometry: Polar Form
Find to the nearest degree the amplitude of $2 + 5i$.
- 51 1960_01_TWA_51 Numbers: Complex
Express $4(\cos 150^\circ + i \sin 150^\circ)$ in $a + bi$ form.
- 52 1960_01_TWA_52 Equations: Roots of Higher Order
Express *one* of the roots of $x^4 + 8 = 0$.

53 1960_01_TWA_53 Matrices

Evaluate the determinant $\begin{vmatrix} 3 & 0 & 2 \\ 4 & -2 & 1 \\ 1 & 5 & 3 \end{vmatrix}$

*This question is based upon one of the optional topics in the syllabus.

54 1960_01_TWA_54 Matrices

Write in determinant form an expression for the area of the triangle whose vertices are (-2, -1), (3, 2) and (2,3).

*This question is based upon one of the optional topics in the syllabus.

55 1960_01_TWA_55 Matrices

[Write the *number* preceding the correct answer in the space provided.]

The two straight lines whose equations are $4x + y = 10$ and $3x + 2y = 5$ intersect in a point whose abscissa is

(1) $\frac{\begin{vmatrix} 4 & 1 \\ 3 & 2 \end{vmatrix}}{\begin{vmatrix} 10 & 1 \\ 5 & 2 \end{vmatrix}}$ (2) $\frac{\begin{vmatrix} 10 & 1 \\ 5 & 2 \end{vmatrix}}{\begin{vmatrix} 4 & 1 \\ 3 & 2 \end{vmatrix}}$

(3) $\frac{\begin{vmatrix} 4 & 10 \\ 3 & 5 \end{vmatrix}}{\begin{vmatrix} 4 & 1 \\ 3 & 2 \end{vmatrix}}$ (4) $\frac{\begin{vmatrix} 1 & 2 \\ 10 & 5 \end{vmatrix}}{\begin{vmatrix} 10 & 1 \\ 5 & 2 \end{vmatrix}}$

*This question is based upon one of the optional topics in the syllabus.

56 1960_06_TWA_01 Slope

$$2x + 4y + 5 = 0$$

Find the slope of the line.

57 1960_06_TWA_02 Parallel and Perpendicular Lines

$$2x + 4y + 5 = 0$$

Write an equation of the straight line parallel to the given line and passing through the origin.

58 1960_06_TWA_03 Points on a Line: Identification of

$$2x + 4y + 5 = 0$$

Find the x -intercept of the given line.

59 1960_06_TWA_04 Quadratics: Sum and Product of Roots

$$x^3 + 10x + 2 = 0$$

Find the sum of the roots of the equation.

60 1960_06_TWA_05 Quadratics: Sum and Product of Roots

$$x^3 + 10x + 2 = 0$$

Find the product of the roots of the equation.

61 1960_06_TWA_06 Equations: Roots of Higher Order

$$x^3 + 10x + 2 = 0$$

How many rational roots does the equation have?

62 1960_06_TWA_07 Radicals: Solving

Indicate whether the following statement is true for (1) all real values of x , (2) one or more, but not all, real values of x , (3) no real value of x .

$$\sqrt{x^2 + 9} = x + 3$$

63 1960_06_TWA_08 Quadratics: Solving

Indicate whether the following statement is true for (1) all real values of x , (2) one or more, but not all, real values of x , (3) no real value of x .

$$x^2 + 1 = 0$$

64 1960_06_TWA_09 Binomial Expansions

Indicate whether the following statements is true for (1) all real values of x , (2) one or more, but not all, real values of x , (3) no real value of x .

$$(x - 1)^3 = x^3 - 3x^2 + 3x - 1$$

65 1960_06_TWA_10 Quadratics: Inequalities

Indicate whether the following statements is true for (1) all real values of x , (2) one or more, but not all, real values of x , (3) no real value of x .

$$x^2 - 6x + 9 < 0$$

66 1960_06_TWA_11 Numbers: Complex

Express in the form $a + bi$ the reciprocal of $2 + i$.

- 67 1960_06_TWA_12 Polynomials: Factoring
Find the numerical value of a if $x + a$ is a factor of $x^5 + 32$.
- 68 1960_06_TWA_13 Systems: Writing
John travels from A to B , a distance of 30 miles, at the rate of 6 miles per hour, and then without stopping returns from B to A . What should his return rate be in miles per hour, in order that the average rate for the entire trip be 5 miles per hour?
- 69 1960_06_TWA_14 Exponents
If $f(x) = (2x)^0 + x^{-\frac{2}{3}}$, find the value of $f(64)$.
- 70 1960_06_TWA_15 Combinatorics: Combinations
There are ten people at a conference. How many different committees of three members each can be formed from these ten people?
- 71 1960_06_TWA_16 Probability: Theoretical
A three-digit number is to be formed using the digits from 1 to 9, inclusive. What is the probability that the number will be odd? [Repetitions of digits are permitted.]
- 72 1960_06_TWA_17 Probability: Theoretical
Three cards (ace, king, jack) are face down on a table. If two of these cards are picked at random, what is the probability that one of them is an ace?
- 73 1960_06_TWA_18 Binomial Expansions
Write in *simplest form* the fourth term *only* of $(1 + i)^6$, where $i = \sqrt{-1}$.
- 74 1960_06_TWA_19 Equations: Literal
The distance that a body falls from rest in t seconds is given by the formula $S = \frac{1}{2}gt^2$, and the final velocity is given by the formula $V = gt$. Express V in terms of g and S .
- 75 1960_06_TWA_20 Fractions: Complex
Express in *simplest form* $\frac{1}{1 + \frac{1}{1+x}}$.
- 76 1960_06_TWA_21 Progressions: Arithmetic
If $\frac{1}{2}$, $\frac{1}{x}$, and $\frac{1}{3}$ are three consecutive terms of an arithmetic progression, find the value of x .
- 77 1960_06_TWA_22 Quadratics: Find Vertex Given Equation
Find the coordinates of the minimum point of the graph of the equation $y = x^2 - 6x + 9$
- 78 1960_06_TWA_23 Alligation
Ten quarts of a solution containing $x\%$ antifreeze is mixed with twenty quarts of a solution containing $y\%$ antifreeze. The fractional part of antifreeze in the resulting mixture is
(1) $\frac{x+2y}{100}$ (2) $\frac{x+2y}{300}$ (3) $\frac{2x+y}{100}$ (4) $\frac{2x+y}{300}$
- 79 1960_06_TWA_24 Logarithms
If $\log_{10} x = 1.5421$, then $10^{3.5421}$ equals
(1) $2 + x$ (2) $2x$ (3) $100 + x$ (4) $100x$
- 80 1960_06_TWA_25 Polynomials: Multiplication and Division of
If $f(x)$ is divided by $x - 2$, the remainder is
(1) $f(2)$ (2) 2 (3) $f(-2)$ (4) -2
- 81 1960_06_TWA_26 Combinatorics: Combinations
If ${}_nC_x = {}_nC_y$, where n , x and y are positive integers such that $x \neq y$, then
(1) $x = \frac{n}{2}$ (2) $y = \frac{n}{2}$ (3) $x + y = n$ (4) $x - y = n$
- 82 1960_06_TWA_27 Variation: Direct
The area of a circle varies directly as the square of its diameter. The constant of variation is
(1) 1 (2) π (3) $\frac{\pi}{4}$ (4) $\frac{1}{4}$

- 83 1960_06_TWA_28 Equations: Forming Quadratics from Roots
If r_1 and r_2 are real roots of the quadratic equation $x^2 + px + q = 0$ such that $r_1 > 0$, $r_2 < 0$ and p and q are integers, it is always true that
(1) $q > 0$ (2) $q < 0$ (3)
 $p > 0$ (4) $p < 0$
- 84 1960_06_TWA_29 Exponential Functions and Equations
If $4^x = 8^y$, then x equals
(1) $\frac{1}{2}y$ (2) $2y$ (3) $\frac{3}{2}y$ (4)
 $\frac{2}{3}y$
- 85 1960_06_TWA_30 Quadratics: Using the Discriminant
In the equation $px^2 + qx + s = 0$, p , q and s are real numbers with $p \neq 0$. If the two roots of the equation are equal, then
(1) $q^2 = 4ps$ (2) $q^2 = -4ps$ (3) $q^2 = ps$ (4)
 $q^2 = -ps$
- 86 1960_06_TWA_31 Equations: Roots of Higher Order
If two of the roots of $x^3 + px + q = 0$ are 3 and -1 , find the third root.
- 87 1960_06_TWA_32 Equations: Roots of Higher Order
If one of the roots $x^3 - 2x^2 + x - 2 = 0$ is 2, find the other two roots.
- 88 1960_06_TWA_33 Equations: Forming Quadratics from Roots
The x -intercepts of the graph of the equation $y = x^2 + bx + c$ are 2 and 3. Find the value of c .
- 89 1960_06_TWA_34 Points on a Line: Identification of
The points $P_1(2, 3)$, $P_2(4, 9)$, $P_3(6, k)$ are collinear. Find the value of k .
- 90 1960_06_TWA_35 Equations: Roots of Higher Order
A possible root of the equation $6x^4 + px^3 + qx^2 + rx + 4 = 0$, where p , q and r are integers is
(1) $\frac{3}{2}$ (2) $-\frac{3}{2}$ (3) -3
(4) $\frac{4}{3}$
- 91 1960_06_TWA_36 Numbers: Complex
If a and b are real numbers, then the product of $a + bi$ and $a - bi$ is
(1) always a real number
(2) sometimes, but not always, a real number
(3) always imaginary
(4) sometimes, but not always, imaginary
- 92 1960_06_TWA_37 Calculus: Integral
A rational integral function of x is
(1) $x + \frac{1}{x}$ (2) $\sqrt{x} + 2$ (3) $x^2 + x^{\frac{3}{2}}$ (4)
 $x + \sqrt{2}$
- 93 1960_06_TWA_38 Circles: Center, Radius and Circumference
The circle whose center is $(3, -2)$ passes through the point $(5, 1)$. Find the length of the radius of the circle.
- 94 1960_06_TWA_39 Progressions: Arithmetic and Geometric
The first term of an arithmetic progression is x and the common difference is 2. The first, third, and seventh terms form a geometric progression. Write an equation that could be used to find the value of the first term.
- 95 1960_06_TWA_40 Combinatorics: Combinations
In how many ways may three pupils be seated in a row containing 5 seats?
- 96 1960_06_TWA_41 Calculus: Differential
Find the slope of the line tangent to the curve whose equation is $y = x^3 - 5x + 2$, at the point where the graph crosses the y -axis.
- 97 1960_06_TWA_42 Calculus: Differential
Find the coordinates of the point of inflection of the curve whose equation is $y = x^3 - 5x + 2$.
- 98 1960_06_TWA_43 Quadratics: Find Vertex Given Equation
The area of a rectangle is represented by $12x - x^2$ where x is a side of the rectangle. For what value of x will the area be a maximum?

- 99 1960_06_TWA_44 Inequalities: Linear
Find the set of values of x that satisfies the inequality $4 - 2x < 10$
- 100 1960_06_TWA_45 Matrices
Write in determinant form an equation of the straight line through the points (3, 2) and (-1, 0).
*This question is based upon optional topics in the syllabus.
- 101 1960_06_TWA_46 Logarithms
Find to the *nearest tenth* the value of $\log_2 5$.
- 102 1960_06_TWA_47 Logarithms
Given $A = Pe^r$. Express r in terms of $\log A$, $\log P$, and $\log e$.
- 103 1960_06_TWA_48 Quadratics: Noninteger Solutions
The positive root of the equation $x^2 + 5x - 7 = 0$ lies between
(1) 1.0 and 1.2 (2) 1.2 and 1.4 (3) 1.4 and 1.6 (4) 1.6 and 1.8
- 104 1960_06_TWA_49 Exponential Functions and Equations
The graph of $y = 3^x$
(1) intersects the x -axis only
(2) intersects the y -axis only
(3) intersects both coordinate axes
(4) does not intersect either axis
- 105 1960_06_TWA_50 Exponents
If r is a positive real number and n is a positive integer, then $r^{-\frac{1}{n}}$ is equal to
(1) $\frac{1}{r^{-n}}$ (2) $\frac{1}{\sqrt[n]{r}}$ (3) $\sqrt[n]{r}$ (4) r^n
- 106 1960_06_TWA_51 Variation: Inverse
If the relation, x varies inversely as y , is represented graphically, the graph will be
(1) a straight line (2) an ellipse (3) a hyperbola (4) a parabola
- 107 1960_06_TWA_52 Exponential Functions and Equations
If in the equation $y = 3^x$, the variable x is increased by 2, then y is
(1) increased by 2 (2) multiplied by 2 (3) increased by 9 (4) multiplied by 9
- 108 1960_06_TWA_53 Quadratics: Imaginary Solutions
If the roots of the equation $x^2 + x + 1 = 0$ are expressed in the form of $a + bi$, then b is equal to
(1) $\pm \frac{1}{2}$ (2) $\pm \frac{3}{2}$ (3) $\pm \frac{\sqrt{3}}{2}$ (4) $\pm \frac{\sqrt{3}}{4}$
- 109 1960_06_TWA_54 Equations: Literal
The area of a rectangle is represented by A , the diagonal by d and one side by s . Express d in terms of A and s .
- 110 1960_06_TWA_55 Quadratics: Sum and Product of Roots
In the equation $x^2 + ax + b = 0$, one root is twice the other. Express b in terms of a .
- 111 1960_06_TWA_56 Numbers: Complex
Express in the form $a + bi$: $2(\cos 120^\circ + i \sin 120^\circ)$
- 112 1960_06_TWA_57 Trigonometry: Polar Form
Express in polar form: $-3i$
- 113 1960_06_TWA_58 Trigonometry: Polar Form
Find the amplitude of the complex number $\left[1(\cos 40^\circ + i \sin 40^\circ)\right]^{\frac{1}{2}}$ which, when represented graphically, lies in the third quadrant.
- 114 1960_06_TWA_59 Trigonometry: Polar Coordinates
The polar coordinates of a point P are $\left(2, \frac{\pi}{3}\right)$. If $\left(x, \frac{4\pi}{3}\right)$ are the coordinates of the same point, find the value of x .
This question is based upon optional topics in the syllabus.

- 115 1960_06_TWA_60 Trigonometry: Polar Form
The equation of a circle in polar form is $r = 6 \sin \theta$. Write an equation of this circle in rectangular form. This question is based upon optional topics in the syllabus.
- 116 1960_06_TWB_01 Solid Geometry: Prisms and Cylinders
The lateral area of a prism is 90. If a right section is a regular pentagon whose side is 3, find a lateral edge.
- 117 1960_06_TWB_02 Solid Geometry: Prisms and Cylinders
Two edges of a rectangular solid are 7 and 9 and its diagonal is 12. Find the third edge.
- 118 1960_06_TWB_03 Solid Geometry: Pyramids and Cones
The altitude of a regular square pyramid is 3 times a base edge. If the volume of the pyramid is 1 cubic inch, find the number of inches in the altitude.
- 119 1960_06_TWB_04 Solid Geometry: Pyramids and Cones
The area of the base of a pyramid is 80, the altitude of the pyramid is 12 and the area of a section parallel to the base is 45. Find the distance of the section from the vertex.
- 120 1960_06_TWB_05 Solid Geometry: Pyramids and Cones
A base edge of a regular square pyramid is 8 and the altitude is 3. Find the lateral area.
- 121 1960_06_TWB_06 Solid Geometry: Prisms and Cylinders
The radius of the base of a right circular cylinder is 4. If the lateral area is equal to the sum of the areas of the two bases, find the altitude.
- 122 1960_06_TWB_07 Solid Geometry: Pyramids and Cones
An equilateral triangle is revolved through 180° about an altitude as an axis. If a side of the triangle is s , find the lateral area of the cone formed in terms of s .
- 123 1960_06_TWB_08 Solid Geometry: Pyramids and Cones
The lateral area of a frustum of a regular triangular pyramid is 84. If the base edges are 4 and 3, find the slant height.
- 124 1960_06_TWB_09 Solid Geometry: Pyramids and Cones
The lateral area of two similar cones are in the ratio of 4 : 9. Find the ratio of the volume of the smaller cone to the volume of the larger.
- 125 1960_06_TWB_10 Solid Geometry: Spherical Polygons
An equilateral spherical triangle is equal to a lune whose angle is 30° . Find the number of degrees in one angle of the triangle.
- 126 1960_06_TWB_11 Solid Geometry: Spheres
The number of square units in the area of a sphere is equal to the number of cubic units in its volume. Find the radius of the sphere.
- 127 1960_06_TWB_12 Solid Geometry: Spheres
On a sphere whose radius is 10 inches, the plane of a small circle is 8 inches from the center. Find the number of inches in the radius of the small circle.
- 128 1960_06_TWB_13 Solid Geometry: Spherical Polygons
The number of degrees in each angle of an equilateral spherical triangle is a . Find the number of degrees in the perimeter of the polar triangle in terms of a .
- 129 1960_06_TWB_14 Solid Geometry: Pyramids and Cones
If the altitude of a right circular cone is 10 and the radius of the base is 4, find to the *nearest degree* the angle that an element makes with the base.
- 130 1960_06_TWB_15 Solid Geometry: Lines and Planes in Space
A line segment 12 inches long is inclined at an angle of 60° to a plane. Find in inches the length of its projection on the plane.
- 131 1960_06_TWB_16 Solid Geometry: Prisms and Cylinders
The altitude of a prism is $\sqrt{3}$ and its base is an equilateral triangle. If the volume of the prism is 48, find a base edge.
- 132 1960_06_TWB_17 Solid Geometry: Prisms and Cylinders
The altitude of a circular cylinder is twice the diameter of the base. Express the volume of the cylinder in terms of d , the diameter of the base.

- 133 1960_06_TWB_18 Solid Geometry: Pyramids and Cones
The radii of the bases of a frustum of a right circular cone are 7 and 2. The slant height may be
(1) 5 (2) 2 (3) 7
(4) 4
- 134 1960_06_TWB_19 Solid Geometry: Dihedral and Polyhedral Angles
Two face angles of a trihedral angle are 100° and 140° . The third face angle may be
(1) 20° (2) 40° (3) 100°
(4) 120°
- 135 1960_06_TWB_20 Solid Geometry: Spheres
The Northern Hemisphere is divided into two equal zones by the parallel of latitude
(1) 30° N (2) 45° N (3) 50° N
(4) 60° N
- 136 1960_06_TWB_21 Locus
The locus of points at a given distance from a given line consists of
(1) a cylindrical surface
(2) two parallel lines
(3) a spherical surface
(4) two parallel planes
- 137 1960_06_TWB_22 Locus
The locus of points equally distant from two intersecting planes and also at a given distance from a point on their line of intersection is
(1) one circle (2) two circles (3) two points (4) four points
- 138 1960_06_TWB_23 Solid Geometry: Lines and Planes in Space
The projection of a circle on a plane can *never* be
(1) a line segment (2) a circle (3) an ellipse (4) a parabola
- 139 1960_06_TWB_24 Solid Geometry: Lines and Planes in Space
Two planes are always parallel if they are
(1) parallel to the same line
(2) tangent to the same sphere
(3) perpendicular to the same plane
(4) perpendicular to the same line
- 140 1960_06_TWB_25 Solid Geometry: Spheres
If the blank space in the statement below is replaced by the word always, sometimes (but not always), or never, the resulting statement will be true. Select the word that will correctly complete the statement.
If two small circles of a sphere have the same poles, their planes are _____ parallel.
- 141 1960_06_TWB_26 Solid Geometry: Spherical Polygons
If the blank space in the statement below is replaced by the word always, sometimes (but not always), or never, the resulting statement will be true. Select the word that will correctly complete the statement.
If two sides of a spherical triangle are each 135° , the third side is _____ obtuse.
- 142 1960_06_TWB_27 Solid Geometry: Lines and Planes in Space
If the blank space in the statement below is replaced by the word always, sometimes (but not always), or never, the resulting statement will be true. Select the word that will correctly complete the statement.
Plane P intersects plane M in line a and plane N in line b . If a is parallel to b , then M is _____ parallel to N .
- 143 1960_06_TWB_28 Solid Geometry: Spherical Polygons
If the blank space in the statement below is replaced by the word always, sometimes (but not always), or never, the resulting statement will be true. Select the word that will correctly complete the statement.
An exterior angle of a spherical triangle is _____ equal to the sum of the two remote interior angles.
- 144 1960_06_TWB_29 Solid Geometry: Prisms and Cylinders
If the blank space in the statement below is replaced by the word always, sometimes (but not always), or never, the resulting statement will be true. Select the word that will correctly complete the statement.
The diagonals of a parallelepiped _____ bisect each other.

- 145 1960_06_TWB_30 Solid Geometry: Lines and Planes in Space
If the blank space in the statement below is replaced by the word always, sometimes (but not always), or never, the resulting statement will be true. Select the word that will correctly complete the statement.

Two lines that are skew to a third line are _____ skew to each other.

- 146 1960_06_TWB_31 Proofs: Solid Geometry

Prove *either a or b*:

a If two lines are parallel, every plane containing one of these lines, and only one, is parallel to the other. [10]

OR

b A spherical angle is measured by the arc of the great circle described from its vertex as a pole and included between its sides produced if necessary. [10]

- 147 1960_06_TWB_32 Proofs: Solid Geometry

Plane M and line a outside plane M are both perpendicular to plane P . Prove that line a is parallel to plane M . [10]

- 148 1960_06_TWB_33 Solid Geometry: Spherical Polygons

The number of degrees in the angles of a spherical triangle are in the ratio of 3 : 4 : 5. The area of the triangle is equal to the area of a zone of altitude 3 on the same sphere. If the radius of the sphere is 15, find *each* angle of the triangle. [10]

- 149 1960_06_TWB_34 Solid Geometry: Pyramids and Cones

An edge of a regular tetrahedron is s . Show that the

volume of the inscribed cone is $\frac{\pi s^2 \sqrt{6}}{108}$.

[10]

- 150 1960_06_TWB_35 Solid Geometry: Prisms and Cylinders

A wooden form for a small dam is in the shape of a *right prism* whose base is an isosceles trapezoid as shown in the adjacent figure. AB is 3 feet, CD is 5 feet, h is 8 feet and the dam is 44 feet long. The form has been filled with concrete to a depth of 2 feet. Find to the *nearest cubic yard*, the additional number of cubic yards of concrete needed to fill the form. [10]

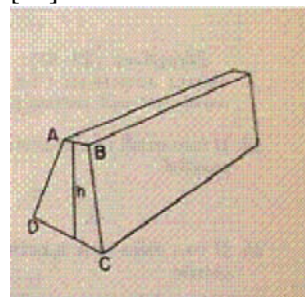

- 151 1960_06_TWB_36 Solid Geometry: Lines and Planes in Space

Answer *either a or b*:

a A pyramid $V-ABCD$, shown in the adjacent figure, has the vertices $V(2, 1, 6)$, $A(0, 0, 0)$, $B(4, 0, 0)$, $C(5, 4, 0)$ and $D(0, 3, 0)$.

(1) Write an equation of the plane through V that is parallel to the base $ABCD$. [2]

(2) Write an equation of the plane that passes through B and D and is parallel to the z -axis. [3]

(3) Find the coordinates of the midpoint of lateral edge VC . [2]

(4) Find the length of lateral edge VC .

[3]

b (1) In spherical triangle ABC , angle $A = 101^\circ$, angle $B = 58^\circ$ and angle $C = 90^\circ$. Find side a to the *nearest degree*. [8]

(2) Using the given data, write an equation that could be used to find side c . [2]

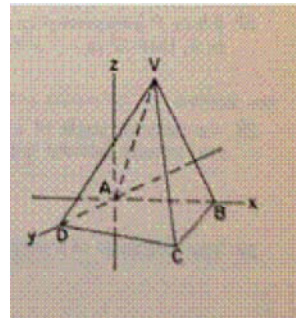

TY - The Tenth Year Curriculum (1950-1970)

- 1 1950_06_TY_01 Triangles: Mean Proportionals
In a right triangle the altitude on the hypotenuse is 6. One segment of the hypotenuse is 4. Find the other segment.
- 2 1950_06_TY_02 Polygons: Interior and Exterior Angles of
Find the number of degrees in an exterior angle of a regular polygon of 12 sides.
- 3 1950_06_TY_03 Medians, Altitudes, Bisectors and Midsegments
In triangle ABC , D and E are the midpoints of AB and BC and DE is drawn. Find the ratio of DE to AC .
- 4 1950_06_TY_04 Trigonometry: Law of Cosines
Two tangents to a circle from an external point are each 6 inches long and they form an angle of 60° . Find the length of the chord joining their points of contact.
- 5 1950_06_TY_05 Circles: Tangents
Two tangents are drawn to a circle from a point outside the circle. One of the intercepted arcs is 100° . Find the number of degrees in the angle formed by the two tangents.
- 6 1950_06_TY_06 Trigonometry: Finding Angles
In triangle ABC , angle C is a right angle, $AB = 12$ and $AC = 6$. Find the number of degrees in angle B .
- 7 1950_06_TY_07 Circles: Chords, Secants and Tangents
A tangent and a secant are drawn to a circle from an external point. The secant is 12 and its external segment is 3. Find the length of the tangent.
- 8 1950_06_TY_08 Midpoint
The coordinates of point A are $(a, 2a)$ and of point B $(3a, 4a)$. Find, in terms of a , the coordinates of the midpoint of the line segment AB .
- 9 1950_06_TY_09 Distance
Find the length of the line segment AB if the coordinates of point A are $(-3, 0)$ and of point B $(-7, 6)$. [Answer may be left in radical form.]
- 10 1950_06_TY_10 Locus
Write the equation of the locus of points equidistant from the points $(4, 10)$ and $(6, 10)$.
- 11 1950_06_TY_11 Similarity
Corresponding sides of two similar triangles are in the ratio 1 :4. Find the ratio of a pair of corresponding altitudes.
- 12 1950_06_TY_12 Trigonometry: Finding Area
If two adjacent sides of a parallelogram are 8 and 10 and the included angle is 45° , find the altitude to side 10. [Answer may be left in radical form.]
- 13 1950_06_TY_13 Triangles: Equilateral
Find the area of an equilateral triangle whose side is 5. [Answer may be left in radical form.]
- 14 1950_06_TY_14 Special Quadrilaterals: Rhombuses
Find the area of a rhombus whose diagonals are 8 and 10.
- 15 1950_06_TY_15 Circles: Center, Radius and Circumference
The circumference of a circle is 12π . Find the radius of the circle.
- 16 1950_06_TY_16 Circles: Area of
Find the area of a sector of a circle whose radius is 5, if the angle of the sector is 40° . [Answer may be left in terms of π .]
- 17 1950_06_TY_17 Triangles: Isosceles
In isosceles triangle ABC , AB equals BC . Find, to the nearest integer, the length of the altitude to AC if angle $ABC = 96^\circ$ and $AB = 10$.
- 18 1950_06_TY_18 Medians, Altitudes, Bisectors and Midsegments
If the hypotenuse of a right triangle is 10, find the median to the hypotenuse.

- 19 1950_06_TY_19 Parallel Lines: Angles Involving
If the blank in the following statement is replaced by one of the words always, sometimes, or never, the resulting statement is true. Select the word that will correctly complete the statement.
 If two parallel lines are cut by a transversal, the bisectors of the two interior angles on the same side of the transversal are ... perpendicular to each other.

- 20 1950_06_TY_20 Special Quadrilaterals: Parallelograms
If the blank in the following statement is replaced by one of the words always, sometimes, or never, the resulting statement is true. Select the word that will correctly complete the statement.
 If diagonal AC of quadrilateral $ABCD$ divides it into two congruent triangles, then the quadrilateral is ... a parallelogram.

- 21 1950_06_TY_21 Special Quadrilaterals: Rhombuses
If the blank in the following statement is replaced by one of the words always, sometimes, or never, the resulting statement is true. Select the word that will correctly complete the statement.
 If the diagonals of a quadrilateral are unequal and bisect each other at right angles, the quadrilateral is ... a rhombus.

- 22 1950_06_TY_22 Locus
 The locus of points equidistant from two intersecting lines consists of (a) one point (b) one line (c) two lines

- 23 1950_06_TY_23 Polygons and Circles: Inscribed
 If the center of the circle circumscribed about a triangle lies on one side of the triangle, the triangle is (a) acute (b) right (c) obtuse

- 24 1950_06_TY_24 Proofs: Circle
 To construct a tangent to circle O at point p , a line is drawn perpendicular to OP at point P as shown in the accompanying diagram.

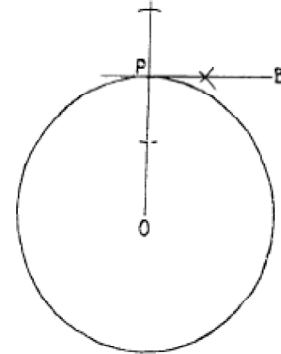

Which of the following statements is the theorem used to prove that BP is tangent to circle O ?

- a A tangent to a circle is a line which has one and only one point in common with the circle.
 b A line perpendicular to a radius at its extremity on the circle is tangent to the circle.
 c A tangent to a circle is perpendicular to the radius drawn to the point of contact.

- 25 1950_06_TY_25 Constructions
 Find by construction the center of the circle of which arc AB is a part.



- 26 1950_06_TY_26 Proofs: Circle
 Prove that a diameter perpendicular to a chord of a circle bisects the chord and its minor arc. [10]

- 27 1950_06_TY_27 Proofs: Polygon
 $ABCD$ is a parallelogram with F a point on BC . A line through D and F intersects AB extended in E .

- a Prove: $\frac{AE}{DC} = \frac{AD}{FC}$ [7]
 b Prove: $AE \times FC = AB \times BC$ [3]

28 1950_06_TY_28 Polygon Proofs
 In parallelogram $ABCD$, AD is longer than DC and diagonal AC is drawn. Prove that AC does not bisect angle C . [10]

29 1950_06_TY_29a Polygons and Circles: Inscribed
 The sides of a triangle inscribed in a circle have arcs represented by $2x - 10^\circ$, $3x + 30^\circ$ and $x + 40^\circ$. Show that two sides of the triangle are equal. [4]

30 1950_06_TY_29b Circles: Equations of
 A circle whose center is the point $(3, 5)$ passes through the origin. Without constructing the circle, show that the point $(8, 2)$ lies on the circle and that the point $(7, 1)$ does not lie on the circle. [4, 2]

31 1950_06_TY_30 Circles: Chords, Secants and Tangents
 In the diagram at the right AC is tangent to circle O at C , M is the midpoint of arc CE and chord DE is parallel to AC .

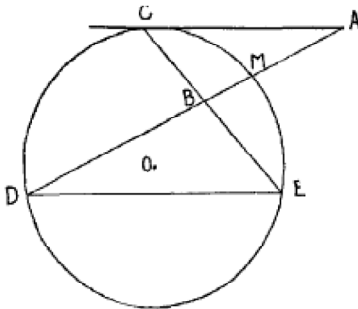

a If the ratio of arc CME to arc ED is 5:8, find the number of degrees in arc CME and in arc ED . [5]

b Find the number of degrees in angle ACE , angle DBE and angle A . [1, 2, 2]

32 1950_06_TY_31 Trigonometry: Finding Sides Using Two Triangles
 In the diagram at the right P represents a point 310 feet from the foot of a vertical cliff BC . AB is a flagpole standing on the edge of the cliff. At P the angle of elevation of B is 21° and of A is 25° . Find, to the nearest foot,
 a the distance AC [4]
 b the length of the flagpole AB [6]

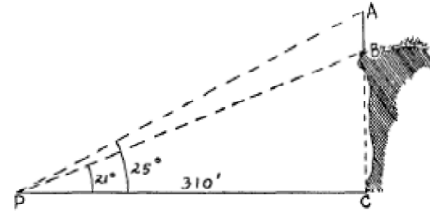

33 1950_06_TY_32 Special Quadrilaterals: Parallelograms
 a The vertices of parallelogram $ABCD$ have the following coordinates: $A(5,7)$, $B(4,-5)$, $C(-1,4)$ and $D(0,y)$.

(1) Find the slope of CE . [3]

(2) Express the slope of DA in terms of y . [2]

(3) Using the results found in answer to (1) and (2), find the value of y . [3]

b Find the abscissa of the point of intersection of the lines $y = 2x + 3$ and $y = -3x + 18$. [2]

*This question is based upon one of the optional topics in the syllabus.

34 1950_06_TY_33a Polygons: Interior and Exterior Angles of
 Indicate whether the information given is *too little*, *just enough*, or *more than necessary*, to justify the conclusion.

If a polygon is equiangular, then it is regular. [2]

35 1950_06_TY_33b Medians, Altitudes, Bisectors and Midsegments
 Indicate whether the information given is *too little*, *just enough*, or *more than necessary*, to justify the conclusion.

If two line segments join the midpoints of the opposite sides of a quadrilateral, then the line segments bisect each other. [2]

- 36 1950_06_TY_33c Equations and Expressions: Using Substitution in
Indicate whether the information given is *too little*, *just enough*, or *more than necessary*, to justify the conclusion.
If $x + y = 5$, $x - y = 1$, and $2x - y = 4$, then $x = 3$ and $y = 2$. [2]
- 37 1950_06_TY_33d Central Tendency: Averages
Indicate whether the information given is *too little*, *just enough*, or *more than necessary*, to justify the conclusion.
If, in every mathematics test, a boy received either an 80% or a 90% grade, then his average mark was 85%. [2]
- 38 1950_06_TY_33e Percent
Indicate whether the information given is *too little*, *just enough*, or *more than necessary*, to justify the conclusion.
Mr. A lives in a certain town in which property is assessed at 75% of its true value. If his property is assessed for \$6000 and the tax rate is 3%, then the tax on his property can be computed. [2]
- 39 1950_06_TY_34 Polygons and Circles: Inscribed
A design in the shape of a regular hexagon inscribed in a circle is to be made from a piece of wire 86 inches long. The wire is to be cut into two pieces such that one piece may be used to form the hexagon and the other to form the circle.
a If x represents the radius of the circle, write an equation which can be used to find x . [5]
b Using $\pi = \frac{22}{7}$, find the length of each part of the wire. [5]
- 40 1960_06_TY_01 Triangles: Interior and Exterior Angles of
The angles of a triangle are in the ratio 1 : 4 : 5. Find the number of degrees in the smallest angle of the triangle.
- 41 1960_06_TY_02 Polygons and Circles: Inscribed
Triangle ABC is inscribed in a circle. If angle $A = 55^\circ$, find the number of degrees in minor arc BC .
- 42 1960_06_TY_03 Midpoint
Given points $A (-3, 9)$ and $B (11, -5)$. Find the coordinates of the midpoint of the line segment AB .
- 43 1960_06_TY_04 Polygons: Interior and Exterior Angles of
An interior angle of a regular polygon is 162° . Find the number of sides of the polygon.
- 44 1960_06_TY_05 Distance
Find the length of the line segment joining the points $(8, 4)$ and $(5, 2)$.
- 45 1960_06_TY_06 Locus
Write an equation of the locus of points such that the sum of the coordinates is 12.
- 46 1960_06_TY_07 Circles: Tangents
Two tangents are drawn to a circle from a point. If one of the intercepted arcs is 160° , what is the number of degrees in the angle formed by the two tangents?
- 47 1960_06_TY_08 Triangles: Mean Proportionals
In a right triangle the altitude is drawn upon the hypotenuse. If the segments of the hypotenuse cut off by the altitude are 16 and 25, what is the length of the altitude.
- 48 1960_06_TY_09 Polygons: Area of
The area of a regular polygon is 144 square inches and its perimeter is 48 inches. Find the number of inches in the length of its apothem.
- 49 1960_06_TY_10 Circles: Area of
The radius of one circle is 2 and the radius of a second circle is 5. What is the ratio of the area of the first circle to the area of the second circle.
- 50 1960_06_TY_11 Triangles: Equilateral
Find the length of an altitude of an equilateral triangle whose side is 2.
- 51 1960_06_TY_12 Locus
Two points, A and B , are 7 inches apart. How many points are there which are 10 inches from A and 3 inches from B ?

52 1960_06_TY_13 Locus
The locus of points equidistant from two given concentric circles is a third circle. If the radii of the given circles are 7 and 15, what is the radius of the third circle?

53 1960_06_TY_14 Circles: Chords, Secants and Tangents
From a point outside a circle a tangent and a secant are drawn to the circle. If the circle divides the secant into an internal segment of 12 inches and an external segment of 4 inches, find the number of inches in the length of the tangent.

54 1960_06_TY_15 Trigonometry: Finding Sides
In triangle ABC , angle $A = 22^\circ$ and angle $C = 90^\circ$. If side $AC = 5$, find BC to the nearest integer.

55 1960_06_TY_16 Locus
Write an equation of the locus of points equidistant from the points $(7, 12)$ and $(7, -6)$

56 1960_06_TY_17 Triangles: Pythagoras
If the hypotenuse of a right triangle is $6\sqrt{2}$ and one leg is 6, find the length of the other leg.

57 1960_06_TY_18 Special Quadrilaterals: Rhombuses
Find the area of a rhombus whose diagonals are 5 and 6.

58 1960_06_TY_19 Circles: Arc Measure
In a circle of radius 9, find the length of an arc of 10° .

59 1960_06_TY_20 Circles: Chords
Two chords AB and CD of a circle intersect at point P within the circle. If $AP = a$, $PB = b$ and $CP = c$, express the length of PD in terms of a , b , and c .

60 1960_06_TY_21 Complementary, Supplementary and Vertical Angles
In the accompanying figure, ACB is a straight angle and DC is perpendicular to CE .

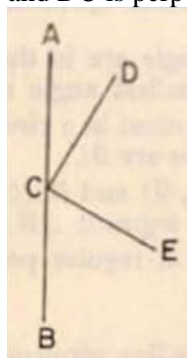

If the number of degrees in angle ACD is represented by x , the number of degrees in angle BCD is represented by

- (1) $90 - x$ (2) $x - 90$ (3) $90 + x$ (4) $180 - x$

61 1960_06_TY_22 Similarity
The ratio of the perimeters of two similar pentagons is 4 : 1. The ratio of two corresponding sides is

(1) 5 : 1 (2) 2 : 1 (3) 16 : 1 (4) 4 : 1

62 1960_06_TY_23 Logical Reasoning: Contrapositive
Given : All men are mortal. Which statement expresses a conclusion that logically follows from the given statement?

(1) All mortals are men.
(2) If x is mortal, then x is a man.
(3) If x is not a mortal, then x is not a man.
(4) If x is not a man, then x is not a mortal.

63 1960_06_TY_24 Triangles: Interior and Exterior Angles of
Given triangle ABC with side AC extended through C to D . If angle BCD is represented by x and angle BCA is represented by y , then for all triangles ABC

(1) $\angle x > \angle A$ (2) $\angle x < \angle A$ (3) $\angle x > \angle y$ (4) $\angle x < \angle y$

64 1960_06_TY_25 Similarity

If the blank space in the statement below is replaced by the word *always*, *sometimes (but not always)*, or *never*, the resulting statement will be true. Select the word that will correctly complete the statement.

If two triangles have two angles of one equal to two angles of another, the triangles are _____ similar.

65 1960_06_TY_26 Polygons: Interior and Exterior Angles of

If the blank space in the statement below is replaced by the word *always*, *sometimes (but not always)*, or *never*, the resulting statement will be true. Select the word that will correctly complete the statement.

If a polygon is equilateral, it is _____ equiangular.

66 1960_06_TY_27 Circles: Chords

If the blank space in the statement below is replaced by the word *always*, *sometimes (but not always)*, or *never*, the resulting statement will be true. Select the word that will correctly complete the statement.

An inscribed angle which intercepts an arc less than a semicircle is _____ an obtuse angle.

67 1960_06_TY_28 Complementary, Supplementary and Vertical Angles

If the blank space in the statement below is replaced by the word *always*, *sometimes (but not always)*, or *never*, the resulting statement will be true. Select the word that will correctly complete the statement.

The difference between the supplement of an angle and the complement of that angle is _____ a right angle.

68 1960_06_TY_29 Constructions

Inscribe an equilateral triangle in circle O .

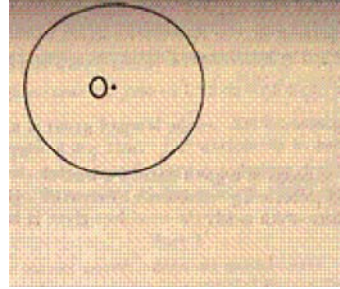

69 1960_06_TY_30 Constructions

Through point P , construct a line parallel to line AB .

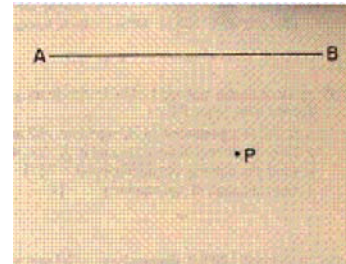

70 1960_06_TY_31 Proofs: Triangle

Prove *either a or b*:

a The sum of the angles of a triangle is equal to a straight angle. [10]

OR

b If in a right triangle the altitude is drawn upon the hypotenuse,

(1) the two triangles thus formed are similar to the given triangle and similar to each other [7] and

(2) each leg of the given triangle is the mean proportional between the hypotenuse and the projection of that leg on the hypotenuse. [3]

71 1960_06_TY_32 Medians, Altitudes, Bisectors and Midsegments

The vertices of a triangle are $A(1,1)$, $B(3,5)$ and $C(7,2)$.

a Using graph paper, draw triangle ABC .

[1]

b Find the area of triangle ABC [4]

c Find the length of BC . [2]

d Using the results obtained in *b* and *c*, find the altitude from A to BC . [3]

- 72 1960_06_TY_33 Circles: Tangents
Two unequal circles are tangent externally at point A . Line segment BC is a common external tangent touching the circles at B and C , respectively. The common internal tangent at A intersects BC at D .
 a Prove that D is the midpoint of BC . [6]
 b If angle CAD is represented by c and angle BAD is represented by y , prove that $x + y = 90^\circ$. [4]
- 73 1960_06_TY_34 Locus
Given point O on line AB
 a Describe *fully* the locus of points at a given distance d from O . [2]
 b Describe *fully* the locus of points at a given distance s from AB . [2]
 c How many points are there which satisfy the conditions given in both a and b if
(1) $d > s$? [2]
(2) $d = s$? [2]
(3) $d < s$? [2]
- 74 1960_06_TY_35 Special Quadrilaterals: Trapezoids
In an isosceles trapezoid $ABCD$, the bases are AB and DC ; AD is 5 more than DC and AB is 2 more than twice DC .
 a If DC is represented by x , represent AD and AB in terms of x . [2]
 b If the perimeter of the trapezoid is 52, find the value of x . [3]
 c Find the altitude of the trapezoid. [3]
 d Find the area of the trapezoid. [2]
- 75 1960_06_TY_36 Special Quadrilaterals: Rhombuses
In rhombus $ABCD$, diagonal $AC = 60$ and angle $BAC = 36^\circ$.
 a Find the length of a side of the rhombus to the *nearest integer*. [5]
 b Find the length of an altitude of the rhombus to the *nearest integer*. [5]
- 76 1960_08_TY_01 Triangles: Pythagoras
Find the diagonal of a square the length of whose side is 10.
- 77 1960_08_TY_02 Trigonometry: Finding Area
Two adjacent sides of a parallelogram are 8 and 10, and the included angle is 30° . Find the area of the parallelogram.
- 78 1960_08_TY_03 Locus
How many points are there 3 inches from a given line and also equidistant from two fixed points on the given line?
- 79 1960_08_TY_04 Circles: Area of
The radius of a circle is 5 inches. The area of a sector of the circle is 5π square inches. Find the number of degrees in the central angle of the sector.
- 80 1960_08_TY_05 Circles: Chords
In circle O , chords AB and CD intersect at E . If angle AED is 100° and arc AD is 150° , find the number of degrees in arc CB .
- 81 1960_08_TY_06 Special Quadrilaterals: Trapezoids
If the area of a trapezoid is 30 and the lengths of its bases are 10 and 2, find the length of its altitude.
- 82 1960_08_TY_07 Distance
Find the length of the line segment joining the points whose coordinates are $(-1, 3)$ and $(2, 5)$.
- 83 1960_08_TY_08 Triangles: Interior and Exterior Angles of
In triangles ABC and DEF , angle C equals angle E , $AC = EF$ and $BC = ED$. If $AB = 2x - 1$, $BC = 2x + 1$ and $FD = 5x - 4$, find the value of x .
- 84 1960_08_TY_09 Circles: Center, Radius and Circumference
The point $(6, 8)$ lies on a circle with center at the origin. Find the length of the radius of the circle.
- 85 1960_08_TY_10 Locus
Write an equation of the locus of points whose abscissas are -2 .
- 86 1960_08_TY_11 Circles: Chords
In circle O , chord AC and central angle AOC are drawn. If the radius of the circle is 10 inches and central angle AOC is 50° , find to the *nearest inch* the distance from the center of the circle to chord AC .

- 87 1960_08_TY_12 Special Quadrilaterals: Trapezoids
The bases of an isosceles trapezoid are 15 and 9 and the nonparallel sides are each 5. Find the length of its altitude.
- 88 1960_08_TY_13 Similarity
In triangle ABC , point D is on AB and point E is on BC so that DE is parallel to AC . If $AB = 12$, $BE = 8$ and $EC = 7$, find the length of DA .
- 89 1960_08_TY_14 Polygons: Interior and Exterior Angles of
The number of degrees in each interior angle of a regular polygon is twice the number of degrees in an exterior angle of the polygon. Find the number of sides of the polygon.
- 90 1960_08_TY_15 Polygons: Area of
A regular polygon of 8 sides is equal in area to a triangle. If the apothem of the polygon equals the altitude of the triangle, and the base of the triangle is 24, find a side of the polygon.
- 91 1960_08_TY_16 Special Quadrilaterals: Rhombuses
A side of a rhombus is 17 and one diagonal is 16. Find the length of the other diagonal.
- 92 1960_08_TY_17 Special Quadrilaterals: Parallelograms
In a parallelogram, the number of degrees in the *unequal* angles is represented by $3x - 4$ and $2x + 9$. Find the number of degrees in the larger of the two angles.
- 93 1960_08_TY_18 Triangles: Equilateral
Find the length of the side of an equilateral triangle whose area is $9\sqrt{3}$.
- 94 1960_08_TY_19 Circles: Chords
In circle O , diameter AB meets chord BC at B . If arc BC is 70° , find the number of degrees in angle ABC .
- 95 1960_08_TY_20 Circles: Chords, Secants and Tangents
 AB is tangent to circle O at point A , and secant BCD is drawn so that BD is 50 and BC is 2. Find the length of tangent AB .
- 96 1960_08_TY_21 Similarity: Right Triangles
A tree on level ground casts an 18-foot shadow at the same time that a 5-foot pole casts a 3-foot shadow. Find the number of feet in the height of the tree.
- 97 1960_08_TY_22 Definitions: Geometry
A postulate is best defined as
(1) a statement which has been assumed
(2) a statement which has been deduced
(3) a statement which is obviously true
(4) a statement which follows readily from a previously accepted statement
- 98 1960_08_TY_23 Logical Reasoning: Converse
Give the following example of reasoning: "If a man is a good citizen, he pays his taxes. Mr. Smith pays his taxes. Therefore, Mr. Smith is a good citizen." Which statement describes the reasoning used in this example?
(1) The argument is not valid because it uses circular reasoning.
(2) The argument is not valid because it uses indirect reasoning.
(3) The argument is not valid because it uses reasoning from the converse.
(4) The argument is valid.
- 99 1960_08_TY_24 Proofs: Circle
Which of the following represents the order in which the statements below would be placed if they were arranged in sequence in which they were postulated or proved?
 a An angle inscribed in a circle is measured by one-half its intercepted arc.
 b A central angle is measured by its intercepted arc.
 c An angle formed by two secants is measured by one-half the difference of the intercepted arcs.
(1) a, b, c (2) a, c, b (3) b, a, c (4) c, b, a

100 1960_08_TY_25 Logical Reasoning: Converse
Which is a converse of the statement “If two parallel lines are cut by a transversal, corresponding angles are equal”?

- (1) Corresponding angles of parallel lines are equal.
- (2) If two lines are cut by a transversal and a pair of corresponding angles are equal, the lines are parallel.
- (3) If two parallel lines are cut by a transversal, alternate interior angles are equal.
- (4) Alternate interior angles of parallel lines are equal.

101 1960_08_TY_26 Special Quadrilaterals: Parallelograms
Which statement is true?

- (1) A parallelogram inscribed in a circle must be a rectangle.
- (2) A parallelogram inscribed in a circle must be a rhombus.
- (3) A parallelogram inscribed in a circle must be a square.
- (4) A parallelogram cannot be inscribed in a circle.

102 1960_08_TY_27 Special Quadrilaterals: Rectangles and Squares
In a certain quadrilateral one pair of opposite sides are equal and parallel and one of the angles is a right angle.

The quadrilateral *must* be a

- (1) trapezoid (2) square (3) rhombus (4) rectangle

103 1960_08_TY_28 Circles: Area of
If the radius of a circle is doubled,

- (1) the circumference and the area are each doubled
- (2) the circumference is doubled and the area is multiplied by four
- (3) the circumference and the area are each multiplied by four
- (4) the area is doubled and the circumference is multiplied by four

104 1960_08_TY_29 Constructions
Through A construct a line parallel to BD .

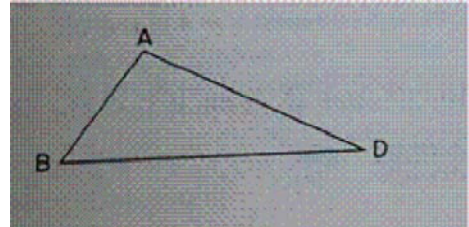

105 1960_08_TY_30 Constructions
Construct the locus of the centers of circles which are tangent to line AB at P .

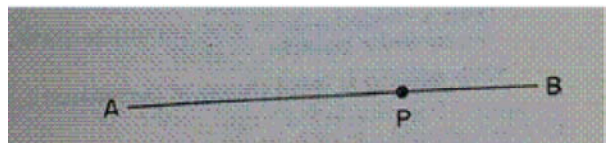

106 1960_08_TY_31a Proofs: Triangle
Prove:
The sum of the angles of a triangle is equal to a straight angle. [10]

107 1960_08_TY_31b Circles: Chords
Prove:
An angle formed by two chords intersecting inside the circle is measured by one-half the sum of the intercepted arcs. [10]

108 1960_08_TY_32 Proofs: Circle
In circle O , point E lies between A and O on diameter AB . Chord CD is perpendicular to AB at E . CA , CB and DB are drawn.
Prove : $EB \times AB = CB \times DB$ [10]

109 1960_08_TY_33 Proofs: Triangle
Triangle ABC is isosceles, with vertex angle C . CA is extended through A to D , and CB is extended through B to E , so that $AD > BE$. Line DE is drawn.
 a Prove: angle $CED >$ angle CDE [6]
 b If angle CDE contains x degrees and angle CED is 10 degrees more than angle CDE , express angle CAB in terms of x . [4]

- 110 1960_08_TY_34 Trigonometry: Finding Sides
An observer stands at a window so that his eye height is 13 feet above a level street. He notes that the angle of depression of the foot of a building across the street is 20° and that the angle of elevation of the top of the same building is 35° . Find to the *nearest foot* the height of the building. [10]

- 111 1960_08_TY_35 Polygons and Circles: Inscribed
A circle is inscribed in an equilateral triangle whose sides is 12 inches. Another triangle is formed within the circle by joining the points of tangency of the circle and the original triangle. Find, to the *nearest square inch*, the area of that part of the circle which is *not* included in the inner triangle. [Use the approximate $\pi = 3.14$ and $\sqrt{3} = 1.73$.] [10]

- 112 1960_08_TY_36 Special Quadrilaterals: Parallelograms
Given : $A (-5, -1)$, $B (3,1)$, $C (5, 7)$ and $D (-3, 5)$.
Using coordinate geometry, show that
a $ABCD$ is a parallelogram [6]
b $ABCD$ is not a rectangle [4]
- 113 1960_08_TY_37 Proofs: Coordinate
a Plot points $A (2,1)$, $B (6, 7)$, $C (4,9)$. [1]
b Find the coordinates of the midpoint D of AC and the midpoint E of BC . [2]
c Draw DE . Find the slope of DE . [2]
d Find the slope of AB . [2]
e Draw a conclusion from your answers to parts c and d , and quote a theorem of which this is a particular example. [1,2]
* This question is based on one of the optional topics in the syllabus.

- 114 1970_01_TY_01 Triangle Inequalities
In $\triangle ABC$, an exterior angle at A measures 75 degrees. Name the longest side of $\triangle ABC$.

- 115 1970_01_TY_02 Circles: Chords
Radius OE , diameter CD , and chord CE are drawn in circle O as shown.

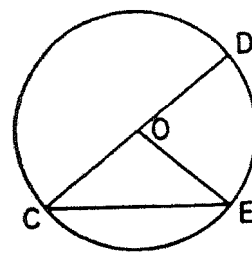

If the measure of angle E is 40, find the measure of angle DOE .

- 116 1970_01_TY_03 Parallel Lines: Angles Involving
In the figure below, $\overleftrightarrow{AB} \parallel \overleftrightarrow{CD}$ and \overleftrightarrow{PQR} and \overleftrightarrow{QS} are drawn.

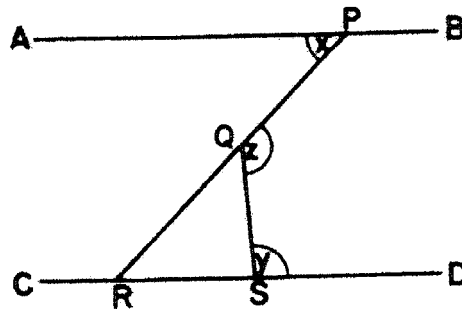

If $m\angle x = 47$ and $m\angle y = 94$, find the measure of angle z .

- 117 1970_01_TY_04 Special Quadrilaterals: Parallelograms
In parallelogram $ABCD$, the number of degrees in angle D is 30 less than twice the number of degrees in angle A . Find the number of degrees in angle A .
- 118 1970_01_TY_05 Triangles: Mean Proportionals
In an isosceles right triangle, the altitude to the hypotenuse is 4 inches. Find the number of inches in the length of the hypotenuse.
- 119 1970_01_TY_06 Similarity
If the areas of two similar polygons are in the ratio 4:9, what is the ratio of their perimeters?

120 1970_01_TY_07 Circles: Arc Measure
The length of the radius of a circle is 9 inches.
Find the length of an arc intercepted by an angle of 80° .

121 1970_01_TY_08 Midpoint
In parallelogram $ABCD$ the coordinates of A are $(4,5)$ and the coordinates of C are $(10,1)$. What are the coordinates of the point of intersection of the diagonals?

122 1970_01_TY_09 Triangles: Pythagoras
Find the length of one side of a square inscribed in a circle with a diameter of length 10.

123 1970_01_TY_10 Trigonometry: Finding Sides
The length of the bases of an isosceles trapezoid are 8 and 12, respectively. Each of the base angles measures 45° . Find the length of the altitude of the trapezoid.

124 1970_01_TY_11 Similarity: Right Triangles
In the figure below, triangle ABC is a right triangle and DE is perpendicular to leg BC .

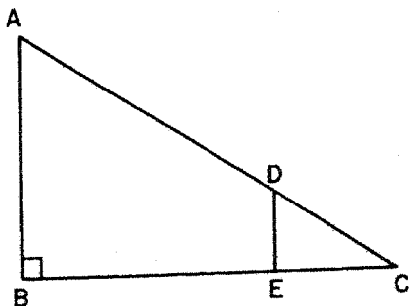

If $AB = 12$, $DE = 4$, and $EC = 6$, find BE .

125 1970_01_TY_12 Circles: Chords
A chord 6 units in length is 4 units from the center of a circle. What is the length of the radius of the circle?

126 1970_01_TY_13 Locus
Write an equation of the locus of points equidistant from the points $A(0,0)$ and $B(0,6)$.

127 1970_01_TY_14 Polygons and Circles: Inscribed
The perimeter of a regular hexagon is 12. Find the length of the diameter of the circle which circumscribes this hexagon.

128 1970_01_TY_15 Circles: Center, Radius and Circumference
In circle O , the area of sector AOB is 20π , and the angle of the sector contains 72° . Find the length of the radius of the circle.

129 1970_01_TY_16 Triangles: Mean Proportionals
In right triangle ABC , altitude CD is drawn to the hypotenuse AB . If $AB = 9$ and $DB = 4$, find CD .

130 1970_01_TY_17 Circles: Tangents
In the figure below, \overline{AB} is tangent to circle O , \overline{AD} is tangent to circle O' , and \overline{AC} is a tangent common to both circles.

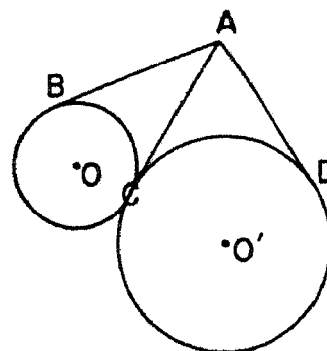

If $AB = 6r - 4$ and $AD = 2r + 8$, what is the value of r ?

131 1970_01_TY_18 Trigonometry: Finding Angles
The length of the base of a rectangle is 9 and the length of a diagonal is 18. Find to the nearest degree the measure of the angle which this diagonal makes with the base.

132 1970_01_TY_19 Polygons: Interior and Exterior Angles of
In a certain regular polygon, the ratio of the number of degrees in an interior angle to the number of degrees in an exterior angle is 3:2. How many sides has the polygon?

133 1970_01_TY_20 Distance

If the coordinates of point A are (1,-2) and the coordinates of point B are (-4,-5), the length of \overline{AB} is

- (1) 9
- (2) $\sqrt{34}$
- (3) $\sqrt{58}$
- (4) $\sqrt{74}$

134 1970_01_TY_21 Triangles: Interior and Exterior Angles of

In the figure below, triangle ABC is isosceles with $AB=CB$.

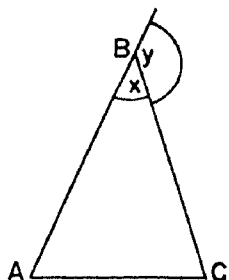

If x is the measure of the vertex angle B and y is the measure of the exterior angle at B , then the measure in degrees of each base angle of the triangle is

- (1) $\frac{1}{2}y$
- (2) $\frac{1}{2}x$
- (3) $90 - y$
- (4) $180 - x$

135 1970_01_TY_22 Special Quadrilaterals: Rhombuses

The lengths of the diagonals of a rhombus are 48 and 20. The length of a side of the rhombus is

- (1) $10\sqrt{2}$
- (2) 52
- (3) $\sqrt{476}$
- (4) 26

136 1970_01_TY_23 Similarity

If the length and the width of a rectangle are both tripled, the ratio of the area of the original rectangle to the area of the enlarged rectangle is

- (1) 1:3
- (2) 1:6
- (3) 1:9
- (4) 1:18

137 1970_01_TY_24 Locus

The locus of points in a plane at a given distance d from a given line in that plane is

- (1) one line
- (2) two lines
- (3) one circle
- (4) two circles

138 1970_01_TY_25 Proofs: Triangle

Consider the three statements:

- a. The sum of the angles of a triangle is equal to one straight angle.
- b. If two angles of one triangle are equal to two angles of another triangle, the third angles are equal.
- c. If two parallel lines are cut by a transversal, the alternate interior angles are equal.

Which represents a common sequence for the proofs of these statements?

- (1) a,b,c
- (2) a,c,b
- (3) b,a,c
- (4) c,a,b

139 1970_01_TY_26 Special Quadrilaterals: Trapezoids

An example of a quadrilateral whose diagonals are equal but do not bisect each other is

- (1) a regular hexagon
- (2) an isosceles trapezoid
- (3) a rhombus
- (4) a rectangle

140 1970_01_TY_27 Special Quadrilaterals: Rhombuses

Given a quadrilateral $ABCD$. The locus of points

equidistant from \overleftrightarrow{AB} and \overleftrightarrow{AD} must include point C if $ABCD$ is a

- (1) trapezoid
- (2) rectangle
- (3) parallelogram
- (4) rhombus

141 1970_01_TY_28 Constructions

The accompanying diagram shows the construction of a perpendicular to line l at point M on l . Which of the following is used in the proof of this construction to show that $\triangle AMN \cong \triangle BMN$?

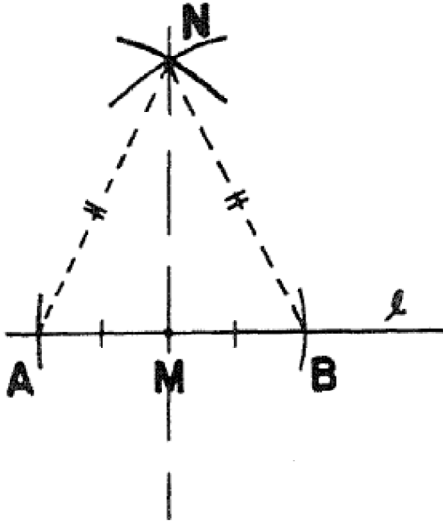

- (1) Two right triangles are congruent if the hypotenuse and leg of one are congruent to the corresponding parts of the other.
- (2) Two triangles are congruent if two angles and the included side on one are congruent to the corresponding parts of the other.
- (3) Two triangles are congruent if the three sides of one are congruent to the three sides of the other.
- (4) Two right triangles are congruent if the hypotenuse and an acute angle of one are congruent to the corresponding parts of the other.

142 1970_01_TY_29 Circles: Center, Radius and Circumference

The circumference of a circle is increased from 30π inches to 50π inches. By how many inches is the length of the radius *increased*?

- (1) 10
- (2) 15
- (3) 20
- (4) 25

143 1970_01_TY_30 Constructions

On the answer sheet, construct and label the altitude \overline{CD} from vertex C of triangle ABC .

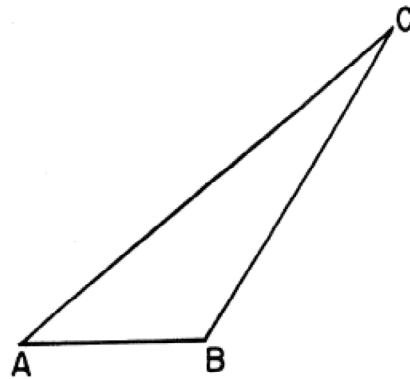

144 1970_01_TY_31a Proofs: Triangle

Prove:

If two angles of a triangle are equal, the sides opposite these angles are equal

145 1970_01_TY_31b Proofs: Polygon

Prove:

The area of a trapezoid is equal to one-half the product of the altitude and the sum of the bases.

146 1970_01_TY_32 Proofs: Triangle

Given: $\overline{AX} \perp \overline{XY}$; $\overline{BY} \perp \overline{XY}$; M , the midpoint of \overline{XY} ; \overline{ARM} , \overline{BSM} , \overline{XR} and \overline{YS} so that $\angle 1 \cong \angle 2$ and $\angle 3 \cong \angle 4$.

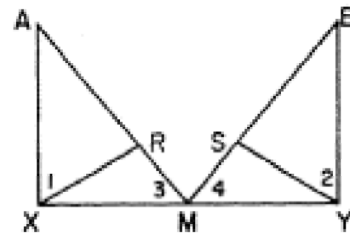

Prove: $\overline{AR} \cong \overline{BS}$ [10]

- 147 1970_01_TY_33 Circles: Chords
Chords are drawn in circle O as shown in the diagram below. Point B is the midpoint of arc CD .

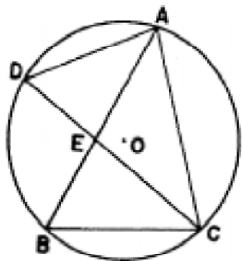

- Prove: $\triangle ABC \sim \triangle ADE$ [7]
- If $AE = 8$, $EB = 7$, and $AC = 12$, find AD . [3]

- 148 1970_01_TY_34 Triangles: Mean Proportionals
In right $\triangle ABC$ as shown in the diagram below, $AB = 17$ and $m\angle A = 22$. Altitude CD is drawn to hypotenuse AB .

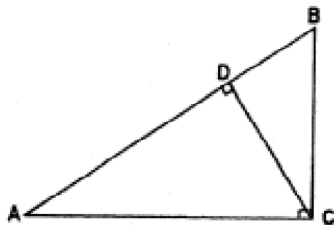

Find to the nearest tenth:

- AC [4]
- CD [6]

- 149 1970_01_TY_35 Proofs: Circle
In circle O if OB and OC are radii and BC is drawn, prove:

- $OB + BC > OA$ [5]
- $BC > BA$ [5]

- 150 1970_01_TY_36 Midpoint
In triangle ABC , the coordinates of B are $(-3, -2)$ and those of C are $(5, 4)$. The midpoint of AB is M whose coordinates are $(-3, 2)$.
Find the:

- coordinates of vertex A [2]
- coordinates of N , the midpoint of BC [2]
- length of MN [2]
- area of $\triangle MNC$ [4]

- 151 1970_01_TY_37 Special Quadrilaterals
The vertices of parallelogram $ABCD$ are $A(-2, 4)$, $B(2, 6)$, $C(7, 2)$, and $D(k, 0)$.

- Find the slope of AB . [2]
- Express the slope of CD in terms of k . [2]
- Using the results obtained in answer to a and b , find the value of k . [3]
- Write an equation of CD . [3]

*This question is based on an optional topic in the syllabus.

- 152 1970_06_TY_01 Special Quadrilaterals: Rhombuses
The diagonals of a rhombus are 10 inches and 24 inches respectively. How many inches long is a side of this rhombus?-

- 153 1970_06_TY_02 Circles: Chords
In the accompanying figure, angle A is formed by diameter AB and chord AC . If $m\angle A = 40$, what is the measure of minor arc AC ?

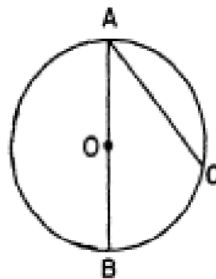

- 154 1970_06_TY_03 Triangles: Interior and Exterior Angles of
In triangle ABC , $AB = BC$. If the number of degrees in angle B is represented by x and the number of degrees in angle A is represented by $(2x - 30)$, find the value of x .

- 155 1970_06_TY_04 Special Quadrilaterals: Trapezoids
The bases of an isosceles trapezoid are 8 and 14, respectively, and a leg is 5. Find the altitude of the trapezoid.

- 156 1970_06_TY_05 Parallel Lines: Angles Involving
In the accompanying figure, BD is the bisector of angle ABC , and EF is parallel to BC .

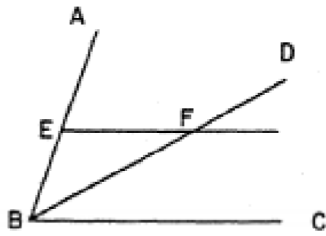

If $m\angle ABC$ is 70 , find the measure of angle BFE .

- 157 1970_06_TY_06 Circles: Area of
The radii of two circles are in the ratio of $4:3$. If the area of the larger circle is 16π , what is the area of the smaller circle?

- 158 1970_06_TY_07 Midpoint
The coordinates of the endpoints of a diameter of circle O are $(2,5)$ and $(6,-1)$, respectively. What are the coordinates of point O ?

- 159 1970_06_TY_08 Similarity: Right Triangles
In the accompanying figure, AD is perpendicular to DC in $\triangle ADC$ and EF is perpendicular to AD at E .

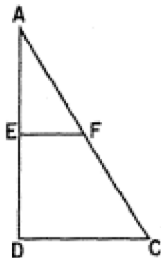

If $DC = 8$, $AD = 12$, and $AE = 6$, find EF .

- 160 1970_06_TY_09 Triangles: Equilateral
The area of an equilateral triangle is $9\sqrt{3}$. Find a side of the triangle.

- 161 1970_06_TY_10 Circles: Chords

Two chords, \overline{AB} and \overline{CD} , intersect inside circle O at point E . The length of AE is 6 , and the length of EB is 8 . If CE is represented by x and ED by $3x$, find the value of x .

- 162 1970_06_TY_11 Polygons: Area of
What is the area of a square whose diagonal is 6 ?

- 163 1970_06_TY_12 Triangles: Interior and Exterior Angles of
An exterior angle at the base of an isosceles triangle contains 110° . How many degrees are in the measure of the vertex angle of the triangle?

- 164 1970_06_TY_13 Polygons: Area of
The side of a regular pentagon is 4 and the apothem is represented by a . Express the area of the pentagon in terms of a .

- 165 1970_06_TY_14 Distance
The coordinates of A are $(-4,-3)$ and the coordinates of C are $(-2,6)$. Find AC .

- 166 1970_06_TY_15 Circles: Tangents
Two tangents to a circle from an external point intercept a major arc of 280° on the circle. Find the number of degrees in the angle formed by the two tangents.

- 167 1970_06_TY_16 Circles: Area of
In a circle whose radius is 12 , the area of a sector is 24π . Find the number of degrees in the central angle of the sector.

- 168 1970_06_TY_17 Circles: Chords, Secants and Tangents
In the accompanying figure, AB is a tangent to circle O and \overline{ACD} is a secant. If $AB = 6$ and $AC = 4$, find AD .

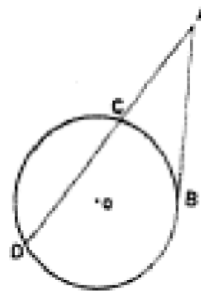

- 169 1970_06_TY_18 Polygons: Interior and Exterior Angles of
If each interior angle of a regular polygon contains 150° , how many sides has the polygon?
(1) 12
(2) 9
(3) 3
(4) 6
- 170 1970_06_TY_19 Medians, Altitudes, Bisectors and Midsegments
If the midpoints of the sides of any quadrilateral are joined in order, the resulting quadrilateral must a
(1) rhombus
(2) rectangle
(3) square
(4) parallelogram
- 171 1970_06_TY_20 Triangles: Pythagoras
Two radii of a circle, \overline{OA} and \overline{OB} , are perpendicular to each other and chord \overline{AB} is drawn. If AB is 10, the length of the radius of the circle is
(1) 5
(2) 10
(3) $5\sqrt{2}$
(4) $10\sqrt{2}$
- 172 1970_06_TY_21 Proportions
On ABC and DEF , $\overline{AB} \cong \overline{DE}$ and $\overline{BC} \cong \overline{EF}$. It follows that
(1) $\overline{AB} + \overline{DE} = \overline{BC} + \overline{EF}$
(2) $\overline{AB} \times \overline{EF} = \overline{BC} \times \overline{DE}$
(3) $\overline{AB} - \overline{BC} = \overline{EF} - \overline{DE}$
(4) $\overline{AD} \cong \overline{CF}$
- 173 1970_06_TY_22 Triangles: Mean Proportionals
If the altitude to the hypotenuse of a right triangle is 8, the segments of the hypotenuse formed by the altitude may be
(1) 8 and 12
(2) 2 and 32
(3) 3 and 24
(4) 6 and 8
- 174 1970_06_TY_23 Circles: Tangents
If for two given circles only two common tangents are possible, the circles
(1) intersect in two points
(2) are concentric
(3) are tangent internally
(4) are tangent externally
- 175 1970_06_TY_24 Special Quadrilaterals: Rhombuses
If a square and rhombus have equal areas, which statement must be true?
(1) The square of a side of the square equals the square of a side of the rhombus.
(2) The product of the diagonals of the square equals the product of the diagonals of the rhombus.
(3) The sum of the sides of the square equals the sum of the sides of the rhombus.
(4) The sum of the diagonals of the square equals the sum of the diagonals of the rhombus.
- 176 1970_06_TY_25 Triangle Inequalities
It is *not* possible for the lengths of the sides of a triangle to be
(1) 3, 3, 2
(2) 4, 3, 2
(3) 5, 4, 2
(4) 6, 3, 2
- 177 1970_06_TY_26 Locus
An equation of the locus of points which are at a distance of 5 units from the origin is
(1) $x = 5$
(2) $y = 5$
(3) $x^2 + y^2 = 5$
(4) $x^2 + y^2 = 25$

- 178 1970_06_TY_27 Trigonometric Ratios: Basic
 If the lengths of the sides of a triangle are 3, 4, and 5, respectively, the value of the tangent of the smallest angle is

- (1) $\frac{3}{5}$
 (2) $\frac{3}{4}$
 (3) $\frac{4}{5}$
 (4) $\frac{4}{3}$

- 179 1970_06_TY_28 Logical Reasoning
 If each of the statements $AB < CD$ and $AB = CD$ leads to a contradiction, then $AB > CD$. This type of reasoning is referred to as

- (1) inductive
 (2) indirect
 (3) direct
 (4) deductive

- 180 1970_06_TY_29 Constructions
 Given $\triangle ABC$ with P on side AC . On the answer sheet, construct a line through point P parallel to AB

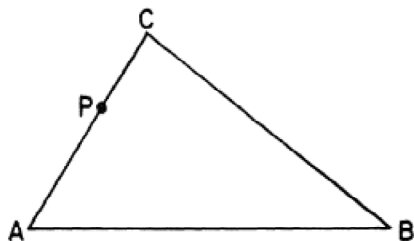

- 181 1970_06_TY_30 Constructions
 On the answer sheet, locate by construction and label the midpoint M of minor arc AB in circle O .

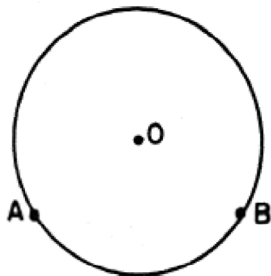

- 182 1970_06_TY_31a Circles: Chords
 A diameter perpendicular to a chord of a circle bisects the chord and its arcs.

- 183 1970_06_TY_31b Proofs: Circle
 Prove:
 An angle inscribed in a circle is measured by one-half its intercepted arc. [Consider only the case where one side of the angle is a diameter.]

- 184 1970_06_TY_32 Proofs: Polygon
 In the accompanying figure, CM is the median to side AB of triangle ABC . AE and BF are perpendicular to CM and AF and BE are drawn.

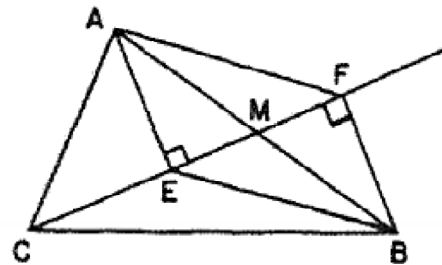

Prove $AEBF$ is a parallelogram. [10]

- 185 1970_06_TY_33 Circles: Chords, Secants and Tangents
 Secants PAB and PCD are drawn to a circle from external point P so that $m\angle P = 20$ and $m\angle ADC = 10$. If $m\widehat{AC}$ is represented by $(3x + y)$ and $m\widehat{BD}$ by $(8x + 4y)$:

- Write a pair of equations which can be used to solve for x and y [4]
- solve these equations to find values for x and y [4]
- find $m\angle BAD$ [2]

- 186 1970_06_TY_34 Proofs: Coordinate
 Given quadrilateral $ABCD$ with vertices at $A(-3,0)$, $B(9,0)$, $C(9,9)$, and $D(0,12)$. If diagonal AC is drawn, find the:

- length of AB [1]
- length of BC [1]
- measure of angle BAC to the nearest degree [2]
- length of diagonal AC [2]
- area of quadrilateral $ABCD$ [4]

187 1970_06_TY_35 Special Quadrilaterals: Rhombuses

In the accompanying figure, \overline{AECD} is a rhombus and $\overline{CB} \perp \overline{AE}$ at B .

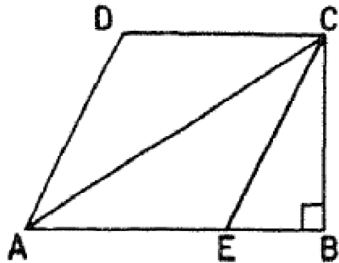

If $AC = 24$ and $m\angle CAB = 30$, find the:

- length of BC [2]
- measure of $\angle CEB$ [2]
- length of CE [2]
- area of $ABCD$ [4]

188 1970_06_TY_36 Proofs: Polygon

Given rectangle $WXYZ$ with A a point on \overline{XY} such that \overline{WY} intersects \overline{ZA} at point P and $\overline{WY} \perp \overline{ZA}$.

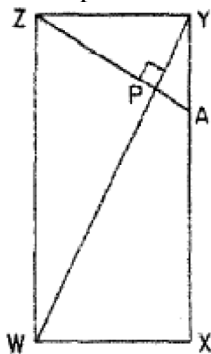

Prove:

- $\triangle WPZ \sim \triangle WZY$ [3]
- $\triangle WPZ \sim \triangle YPA$ [3]
- $\frac{YP}{WZ} = \frac{YA}{WY}$ [4]

189 1970_06_TY_37 Proofs: Coordinate

Given trapezoid $ABCD$ with bases \overline{AB} and \overline{DC} and vertices at $A(0,0)$, $B(10,10)$, $C(k,10)$, and $D(0,6)$.

- Find the slope of \overline{AB} . [2]
- Find the value of k . [3]
- Using the value of k obtained in answer to b , show by coordinate geometry that the median of the trapezoid is equal to one-half the sum of the bases. [5]

*This question is based on an optional topic in the syllabus.

190 1970_08_TY_01 Midpoint

Find the coordinates of the midpoint of the line segment joining the points whose coordinates are $(-3,5)$ and $(5,-9)$.

191 1970_08_TY_02 Polygons: Interior and Exterior Angles of
The measures of the angles of a quadrilateral are in the ratio 3:4:5:6. Find the number of degrees in the measure of the largest angle of the quadrilateral.

192 1970_08_TY_03 Triangles: Isosceles
The measure of each base angle of an isosceles triangle is 15° less than the measure of the vertex angle. Find the number of degrees in the measure of the vertex angle.

193 1970_08_TY_04 Special Quadrilaterals: Rhombuses
The area of a rhombus is 24. The length of one diagonal is 8. Find the length of the other diagonal.

194 1970_08_TY_05 Triangles: Equilateral
If an altitude of an equilateral triangle is $5\sqrt{3}$, what is the length of a side?

195 1970_08_TY_06 Circles: Center, Radius and Circumference
The coordinates of the center of a circle are $(0,0)$. The circle passes through the point whose coordinates are $(-5,12)$. Find the length of the radius of this circle.

196 1970_08_TY_07 Circles: Chords
Two chords, \overline{FG} and \overline{HK} intersect inside a circle at point P . If $FP = 3$, $PC = 4$, and $KP = 6$, find PH .

197 1970_08_TY_08 Medians, Altitudes, Bisectors and Midsegments
In $\triangle ABC$, $m\angle B = 70$ and $m\angle C = 60$. If the bisectors of the angles of the triangle meet at point E , find $m\angle BEC$.

198 1970_08_TY_09 Circles: Tangents
Two tangents drawn to a circle from a point intercept an arc which measures 80° . Find, in degrees, the measure of the angle between the tangents.

199 1970_08_TY_10 Special Quadrilaterals: Trapezoids
In isosceles trapezoid $ABCD$, $m\angle C = 120$, and diagonal \overline{BD} is perpendicular to leg \overline{AD} . Find $m\angle ABD$.

200 1970_08_TY_11 Circles: Area of
The radius of a circle is 6. Find the area of a sector of this circle if the central angle of the sector measures 100° .

201 1970_08_TY_12 Circles: Chords, Secants and Tangents
The diameter \overline{DC} of circle O is extended through C to point P , and secant \overline{PAB} is drawn. If $m\widehat{AB} = 100$ and $m\widehat{AC} = 30$, find $m\angle BPD$.

202 1970_08_TY_13 Trigonometric Ratios: Basic
If the lengths of the sides of a right triangle are 8, 15, and 17, express in fractional form the sine of the smallest angle.

203 1970_08_TY_14 Medians, Altitudes, Bisectors and Midsegments
In the figure below, the nonparallel sides of trapezoid $ABCD$ are extended to intersect at point E .

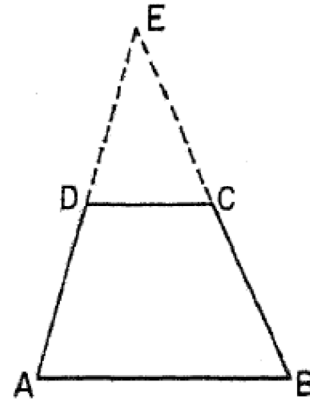

If $AB = 8$, $DC = 4$, and $AD = 5$, find DE .

204 1970_08_TY_15 Polygons: Interior and Exterior Angles of
Find the number of degrees in the measure of an exterior angle of a regular pentagon.

205 1970_08_TY_16 Locus with Equations
Write an equation of the locus of points whose abscissas are 3 less than twice their ordinates.

206 1970_08_TY_17 Circles: Chords
The greatest number of diagonals of a hexagon that may be drawn from one vertex of the hexagon is
(1) 5
(2) 6
(3) 3
(4) 4

207 1970_08_TY_18 Circles: Center, Radius and Circumference
The ratio of the circumference of a circle to its diameter is
(1) 1
(2) 2
(3) π
(4) 2π

- 208 1970_08_TY_19 Circles: Chords
The central angle AOB in circle O measures 60° . If the radius of the circle is 8, the distance from the center of the circle to chord \overline{AB} is
- (1) 8
 - (2) $4\sqrt{2}$
 - (3) $4\sqrt{3}$
 - (4) 4

- 209 1970_08_TY_20 Special Quadrilaterals: Rectangles and Squares
Which *must* be similar?
- (1) two squares
 - (2) two rectangles
 - (3) two triangles
 - (4) two hexagons

- 210 1970_08_TY_21 Locus
Two parallel lines m and n are 4 inches apart. Point A lies on line m . The total number of points equidistant from m and n and 4 inches from A is
- (1) 1
 - (2) 2
 - (3) 3
 - (4) 4

- 211 1970_08_TY_22 Circles: Tangents
Chord \overline{AB} in circle O subtends an arc of 110° . Tangents are drawn to the circle at points A and B , intersecting at P . Triangle APB is
- (1) acute
 - (2) scalene
 - (3) right
 - (4) obtuse

- 212 1970_08_TY_23 Medians, Altitudes, Bisectors and Midsegments
In acute scalene triangle ABC , altitude \overline{CD} is drawn to base \overline{AB} . The ratio of the area of triangle ACD to the area of triangle BCD is
- (1) $AD:DB$
 - (2) $BC:CA$
 - (3) $CA:BC$
 - (4) $AD:BC$

- 213 1970_08_TY_24 Triangle Inequalities
If two sides of a triangle are 8 and 11, respectively, then the third side may be
- (1) 20
 - (2) 2
 - (3) 3
 - (4) 16

- 214 1970_08_TY_25 Special Quadrilaterals: Parallelograms
Which statement about parallelograms is true?
- (1) A circle can be circumscribed about any parallelogram.
 - (2) The bisectors of the opposite angles of any parallelogram are perpendicular to each other.
 - (3) The area of any parallelogram equals the product of its diagonals.
 - (4) The opposite angles of any parallelogram are congruent.

- 215 1970_08_TY_26 Parallel Lines: Angles Involving
Two parallel lines are cut by a transversal, as in the diagram below.

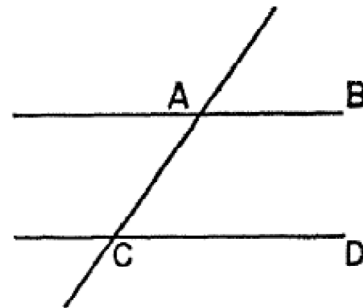

- If $m\angle BAC = (a + 30)$, then $m\angle ACD$ expressed in terms of a is
- (1) $a + 30$
 - (2) $a + 120$
 - (3) $150 - a$
 - (4) $60 - a$

- 216 1970_08_TY_27 Logical Reasoning: Converse
 Consider these statements:
 (A) If a triangle is a right triangle, the square of the length of one of the sides is equal to the sum of the squares of the lengths of the other two sides.
 (B) If the square of the length of one side of a triangle is equal to the sum of the squares of the lengths of the other two sides, the triangle is a right triangle.

Which is true?

- (1) A is the converse of B.
 (2) A is the same as B.
 (3) A is the inverse of B.
 (4) A is the converse of the inverse of B.
- 217 1970_08_TY_28 Triangle Inequalities
 If, in triangle ABC , $AB > BC$, which relationship is not possible?
 (1) $AC > AB$
 (2) $AC = CB$
 (3) $m\angle C < m\angle A$
 (4) $m\angle C = m\angle B$

- 218 1970_08_TY_29 Constructions
 On the answer sheet, given point P on circle O .
 Construct the tangent to circle O at point P .

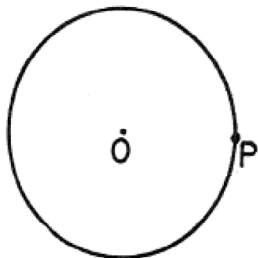

- 219 1970_08_TY_30 Constructions
 On the answer sheet, construct rhombus $ABCD$ with C on \overline{BE} .

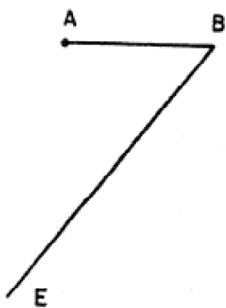

- 220 1970_08_TY_31a Proofs: Circle
 Prove:
 An angle formed by a tangent and a secant is measured by one-half the difference of the intercepted arcs.
- 221 1970_08_TY_31b Proofs: Polygon
 The area of a trapezoid is equal to one-half the product of the altitude and the sum of the bases.

- 222 1970_08_TY_31b Proofs: Polygon
 Prove:
 The area of a trapezoid is equal to one-half the product of the altitude and the sum of the bases.

- 223 1970_08_TY_32 Proofs: Polygon
 Given convex quadrilateral $ABCD$ with $\overline{AB} \cong \overline{AD}$ and $\overline{CB} \cong \overline{CD}$. Prove that the diagonals of the quadrilateral are perpendicular to each other. [10]

- 224 1970_08_TY_33a Polygons: Area of
 In a regular 18-sided polygon, the length of the apothem is 8.4. Find the length of a side of the polygon to the nearest integer [8]

- 225 1970_08_TY_33b Polygons: Interior and Exterior Angles of
 In a regular 18-sided polygon, the length of the apothem is 8.4. Find the sum, in degrees, of the measures of the interior angles of the polygon [2]

- 226 1970_08_TY_34 Proofs: Circle
 Given: chords \overline{AB} and \overline{CD} intersecting at E so that $\overline{DE} \cong \overline{EB}$. Chord \overline{AC} is drawn. [10]

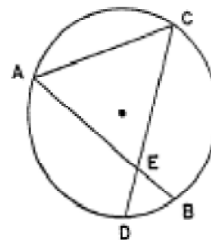

Prove: $\triangle ACE$ is isosceles

227 1970_08_TY_35 Locus with Equations

- Using graph paper draw the locus of points 5 units from the origin. [2]
- Write an equation of this locus. [2]
- Verify that the point $C(-3,4)$ lies on this locus. [2]
- Write the coordinates of the points at which the graph intersects the x -axis. [2]
- Write an equation of a tangent to the locus at one of the points mentioned in part d . [2]

228 1970_08_TY_36 Proofs: Triangle

Given: triangle ABC with E a point on \overline{BC} . \overline{ADE} and \overline{DC} are drawn.

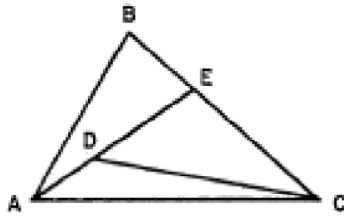

Prove: $m\angle ADC > m\angle B$ [10]

229 1970_08_TY_37 Proofs: Coordinate

The coordinates of the vertices of triangle ABC are $A(-3,-1)$, $B(7,4)$, and $C(2,-6)$.

- Show by means of coordinate geometry that $\triangle ABC$ is isosceles. State a reason for your conclusion. [4]
- Find the coordinates of the midpoint of side \overline{AC} . [2]
- Find the slope of \overleftrightarrow{AC} . [2]
- The slope of the altitude of $\triangle ABC$ from B to \overline{AC} is [2]
 - 1
 - 2
 - $\frac{1}{2}$
 - 1

*This question is based on optional topics in the syllabus

TY - The Tenth Year Curriculum (1980)

230 1980_01_TY_01 Similarity

In the accompanying diagram, $\triangle ABC$, D is a point on \overline{BA} , and E is a point on \overline{BC} such that $\overline{DE} \parallel \overline{AC}$. If $BD = 4$, $BA = 10$, and $BC = 20$, what is the length of \overline{BE} ?

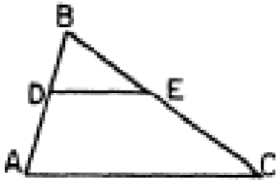

231 1980_01_TY_02 Special Quadrilaterals: Parallelograms

In parallelogram $ABCD$, $AB = 5x - 4$ and $CD = 2x + 14$. Find the value of x .

232 1980_01_TY_03 Special Quadrilaterals: Rectangles and Squares
Quadrilateral $ABCD$ is a rectangle. The coordinates of A , B , and C are $A(5, 0)$, $B(0, 0)$, $C(0, -6)$.

What are the coordinates of point D ?

233 1980_01_TY_04 Polygons and Circles: Inscribed

In the accompanying diagram, isosceles triangle ABC is inscribed in circle O . If $\overline{AB} \cong \overline{BC}$ and $m\widehat{AB} = 150$, find $m\angle B$.

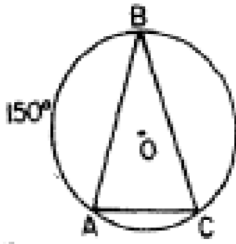

234 1980_01_TY_05 Parallel Lines: Angles Involving

In the accompanying diagram, \overleftrightarrow{AB} is parallel to \overleftrightarrow{CD} and both lines are intersected by transversal \overleftrightarrow{EF} . If $m\angle BEF$ is twice $m\angle DFE$, find $m\angle DFE$.

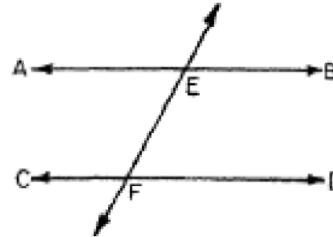

235 1980_01_TY_06 Medians, Altitudes, Bisectors and Midsegments

In the accompanying diagram, triangle ABC is a right triangle, \overline{CE} is the median to hypotenuse \overline{AB} , and $AB = 14$. Find CE .

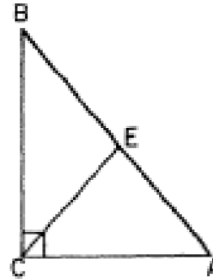

236 1980_01_TY_07 Circles: Arc Measure

In the accompanying diagram, circle O , radii \overline{OA} and \overline{OB} , $OA = 4$, and $m\angle AOB = 90$. Express the length of \widehat{AB} in terms of π .

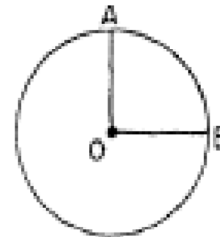

237 1980_01_TY_08 Special Quadrilaterals: Parallelograms

In parallelogram $ABCD$, $m\angle A = 3x$ and $m\angle B = x + 40$. What is the value of x ?

238 1980_01_TY_09 Circles: Chords

In the accompanying diagram, circle O , chord $\overline{AB} \parallel$ chord \overline{CD} , and $m\widehat{AC} = 40$. Chords \overline{AD} and \overline{BC} intersect at E . Find $m\angle AEC$.

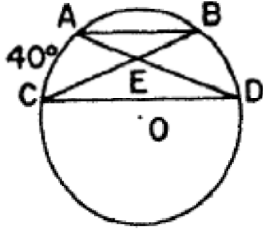

239 1980_01_TY_10 Polygons: Interior and Exterior Angles of
If the sum of the measures of the interior angles of a polygon equals the sum of the measures of the exterior angles, how many sides does the polygon have?

240 1980_01_TY_11 Polygons: Area of
Two rectangles are equal in area. The lengths of the base and altitude of the first rectangle are 8 inches and 5 inches, respectively. If the length of the base of the second rectangle is 10 inches, what is the length, in inches, of its altitude?

241 1980_01_TY_12 Circles: Tangents
In the accompanying figure, \overline{AB} , \overline{BC} , and \overline{AC} are tangent to circle O at points D , E , and F , respectively. If $AF = 5$ and $BE = 4$, find the length of \overline{AB} .

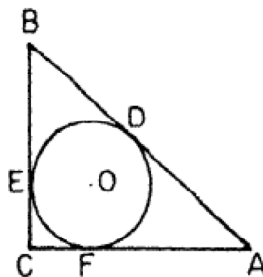

242 1980_01_TY_13 Triangles: Equilateral
Express in radical form the length of an altitude of an equilateral triangle whose side has length 10.

243 1980_01_TY_14 Midpoint
Point M is the midpoint of \overline{CD} . The coordinates of C are $(5, -3)$ and the coordinates of M are $(5, 7)$. What are the coordinates of D ?

244 1980_01_TY_15 Special Quadrilaterals: Rhombuses
The area of a rhombus is 27. If the length of its shorter diagonal is 6, what is the length of its longer diagonal?

245 1980_01_TY_16 Slope
Find the slope of the line which passes through the points whose coordinates are $(-2, 5)$ and $(3, 9)$.

246 1980_01_TY_17 Triangles: Mean Proportionals
In the accompanying diagram, $\triangle ABC$ is a right triangle with right angle at C and $\overline{CD} \perp \overline{AB}$ at D . If $AB = 8$ and $AC = 4$, find AD .

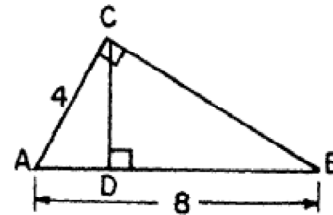

247 1980_01_TY_18 Similarity: Right Triangles
The sides of a triangle have lengths 6, 8, and 10. What is the length of the *shortest* side of a similar triangle that has a perimeter of 12?
(1) 6
(2) 8
(3) 3
(4) 4

248 1980_01_TY_19 Triangles: Interior and Exterior Angles of
The measures of the angles of a triangle are in the ratio of 2:3:4. The measure in degrees of the *smallest* angle of the triangle is
(1) 20
(2) 40
(3) 60
(4) 80

- 249 1980_01_TY_20 Special Quadrilaterals: Parallelograms
 In parallelogram $ABCD$, diagonals \overline{AC} and \overline{DB} intersect at E . Which statement is *always* true?
 (1) Triangle AED is isosceles.
 (2) Triangle ABD is a right triangle.
 (3) Triangle AEB is congruent to triangle AED .
 (4) Triangle ABC is congruent to triangle CDA .
- 250 1980_01_TY_21 Triangle Inequalities
 Which set of numbers could represent the lengths of the sides of a triangle?
 (1) $\{1,2,3\}$
 (2) $\{2,4,6\}$
 (3) $\{3,5,7\}$
 (4) $\{5,10,20\}$
- 251 1980_01_TY_22 Triangles: Pythagoras
 The lengths of the sides of a rectangle are 3 and 8. The length of a diagonal of the rectangle is
 (1) $\sqrt{55}$
 (2) $\sqrt{73}$
 (3) $\sqrt{75}$
 (4) 11
- 252 1980_01_TY_23 Polygons and Circles: Inscribed
 Triangle ABC is inscribed in circle O . If the center of the circle is a point on AB , then triangle ABC must be
 (1) acute
 (2) obtuse
 (3) right
 (4) isosceles
- 253 1980_01_TY_24 Circles: Center, Radius and Circumference
 The coordinates of the endpoints of a diameter of a circle are $(1,1)$ and $(7,9)$. The length of a radius of the circle is
 (1) 5
 (2) 2
 (3) 8
 (4) 15
- 254 1980_01_TY_25 Trigonometric Ratios: Basic
 In $\triangle ABC$, if $m\angle C = 90$, then $\tan A$ is equal to
 (1) $\frac{AB}{AC}$
 (2) $\frac{AC}{AB}$
 (3) $\frac{BC}{AB}$
 (4) $\frac{BC}{AC}$
- 255 1980_01_TY_26 Circles: Area of
 What is the area of a circle whose circumference is 16π ?
 (1) 64π
 (2) 16π
 (3) 8π
 (4) 4π
- 256 1980_01_TY_27 Locus
 Parallel lines l and m are 4 centimeters apart and P is a point on line l . The total number of points that are equidistant from l and m and also 2 centimeters from point P is
 (1) 1
 (2) 2
 (3) 3
 (4) 0
- 257 1980_01_TY_28 Special Quadrilaterals: Trapezoids
 Which statement about the diagonals of an isosceles trapezoid is *always* true?
 (1) They bisect each other.
 (2) They are congruent.
 (3) They are perpendicular to each other.
 (4) They divide the trapezoid into four congruent triangles.

- 258 1980_01_TY_29 Logical Reasoning: Contrapositive
 Assume that the statement, "All geniuses have studied geometry," is true. Which statement must also be true?
- (1) Ron has studied geometry; therefore, Ron is a genius.
 - (2) Mary is not a genius; therefore, Mary has not studied geometry.
 - (3) Lance has not studied geometry; therefore, Lance is not a genius.
 - (4) If Lucy studies geometry, Lucy is a genius.

- 259 1980_01_TY_30 Constructions
 On *the answer sheet*, locate by construction the center of the circle which can be circumscribed about triangle PQR .

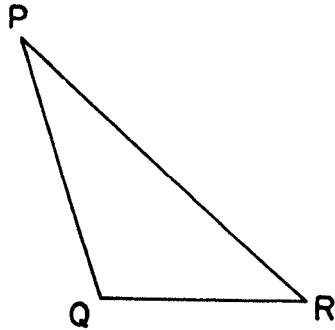

- 260 1980_01_TY_31a Proofs: Triangle
 If two sides of a triangle are congruent, the angles opposite these sides are congruent. [10]

- 261 1980_01_TY_31b Proofs: Circle
 The measure of an angle formed by two chords intersecting inside the circle is equal to one-half the sum of the measures of the intercepted arcs. [10]

- 262 1980_01_TY_32 Proofs: Circle
 Given: circle O , diameter \overline{ADOFB} , arc \overline{ACEB} , $\overline{AD} \cong \overline{BF}$, $\overline{CD} \perp \overline{AB}$, and $\overline{EF} \perp \overline{AB}$.

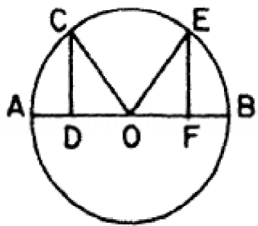

Prove: $\widehat{AC} \cong \widehat{EB}$ [10]

- 263 1980_01_TY_33 Circles: Chords, Secants and Tangents
 Given: circle O with secants \overline{ABC} and \overline{ADE} , chord \overline{EC} , chords \overline{BE} and \overline{CD} intersect at G , \overline{HJ} tangent at E , $m\widehat{CE} = 150$, $m\widehat{BD} = 40$, $m\widehat{BC} = 3x$, and $m\widehat{DE} = 2x$.

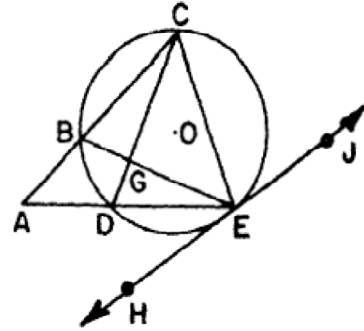

- Find:
- a. x [2]
 - b. $m\angle A$ [2]
 - c. $m\angle CGE$ [2]
 - d. $m\angle AEH$ [2]
 - e. $m\angle BCE$ [2]

- 264 1980_01_TY_34 Proofs: Triangle
 Given: $\triangle ABC$, \overline{ABD} , \overline{BE} bisects $\angle CBD$, $\overline{BE} \parallel \overline{AC}$.

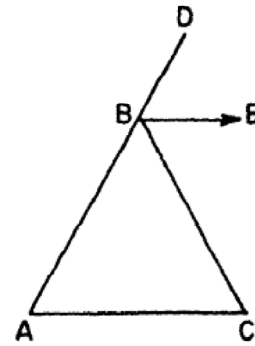

Prove: $\overline{AB} \cong \overline{BC}$ [10]

- 265 1980_01_TY_35 Special Quadrilaterals: Rhombuses
Given: rhombus $ABCD$ with diagonals \overline{BD} and \overline{AC} intersecting at E , $AB = 13$, and $AC = 24$.

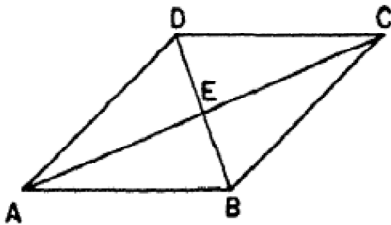

Find:

- BD [3]
 - area of rhombus $ABCD$ [2]
 - $m\angle EAB$ to the nearest degree [5]
- 266 1980_01_TY_36 Proofs: Coordinate
The vertices of triangle ABC are $A(4,4)$, $B(12,10)$, and $C(6,13)$.
- Show that $\triangle ABC$ is *not* equilateral. [4]
 - Find the area of $\triangle ABC$. [6]
- 267 1980_01_TY_37 Proofs: Coordinate
The coordinates of the vertices of quadrilateral $ABCD$ are $A(-4,0)$, $B(6,0)$, $C(8,5)$, and $D(-2,5)$.
- Show by means of coordinate geometry that quadrilateral $ABCD$ is a parallelogram and state a reason for your conclusion. [6]
 - Find the length of the altitude from D to \overline{AB} . [2]
 - Find the area of $ABCD$. [2]
- 268 1980_06_TY_01 Triangles: Interior and Exterior Angles of
In triangle ABC , the measure of angle B is twice the measure of angle A and an exterior angle at vertex C measures 120° . What is the measure in degrees of angle A ?
- 269 1980_06_TY_02 Special Quadrilaterals: Rectangles and Squares
The length of the radius of a circle is 8. What is the length of a diagonal of a rectangle inscribed in the circle?
- 270 1980_06_TY_03 Medians, Altitudes, Bisectors and Midsegments
The sides of a triangle have lengths of 6, 8, and 10. What is the perimeter of the triangle formed by joining the midpoints of these sides?

- 271 1980_06_TY_04 Locus
What is the total number of points that are equidistant from two intersecting lines and are also a distance of 4 centimeters from the point of intersection of the lines?

- 272 1980_06_TY_05 Polygons: Area of
What is the area of a right triangle that has sides of lengths 5, 12, and 13?

- 273 1980_06_TY_06 Circles: Area of
As shown in the accompanying diagram, a small circle lies in the interior of a larger circle. If the lengths of the radii of the two circles are 6 and 9, respectively, find the area of the shaded region.
[Answer may be left in terms of π]

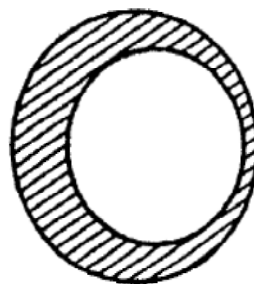

- 274 1980_06_TY_07 Circles: Tangents
The coordinates of the center of a circle are $(3,7)$. If the circle is tangent to the y -axis at point P , what are the coordinates of P ?

- 275 1980_06_TY_08 Distance
The coordinates of the vertices of right triangle ABC are $A(0, 4)$, $B(0,0)$, and $C(4,0)$. Find the length of hypotenuse, \overline{AC} in radical form.

- 276 1980_06_TY_09 Midpoint
The midpoint M of line segment \overline{AB} has coordinates $(4,9)$. If the coordinates of A are $(2,8)$, what are the coordinates of B ?

- 277 1980_06_TY_10 Special Quadrilaterals: Trapezoids
In isosceles trapezoid $DEFG$, $m\angle D$ is three times $m\angle F$. Find $m\angle F$.

278 1980_06_TY_11 Trigonometry: Finding Sides

In the accompanying figure of parallelogram $ABCD$, $m\angle A = 30$, $AB = 10$, and $AD = 4$. What is the area of the parallelogram?

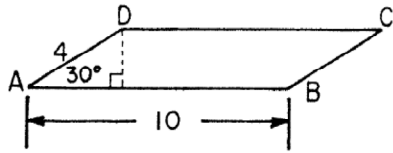

279 1980_06_TY_12 Trigonometry: Finding Angles

A vertical pole 20 meters tall casts a shadow 16 meters long on level ground. Find, to the *nearest degree*, the measure of the angle of elevation of the sun.

280 1980_06_TY_13 Triangles: Interior and Exterior Angles of

The measures of the three angles of a triangle are in the ratio 1:4:5. What is the number of degrees in the measure of the *smallest* angle?

281 1980_06_TY_14 Circles: Chords

Chords AB and CD of circle O intersect at E . If $AE=4$, $EB=5$, and $CE=2$, find DE .

282 1980_06_TY_15 Parallel Lines: Angles Involving

In the accompanying diagram, $\angle 1$ and $\angle 2$ are supplementary. Which is *always* true?

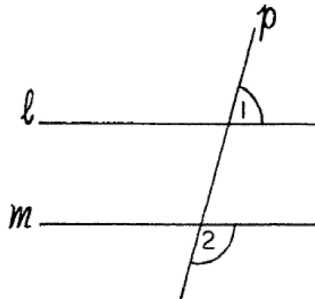

- (1) $l \perp p$
- (2) $l \perp m$
- (3) $l \parallel p$
- (4) $p \parallel m$

283 1980_06_TY_16 Similarity

The lengths of the corresponding sides of two similar polygons are in the ratio 3:5. If the perimeter of the larger polygon is 100, the perimeter of the smaller polygon is

- (1) 64
- (2) 60
- (3) 36
- (4) 30

284 1980_06_TY_17 Special Quadrilaterals: Rectangles and Squares

A rectangle has a diagonal of length 10 and one side of length 6. What is the perimeter of the rectangle?

- (1) 14
- (2) 21
- (3) 28
- (4) 48

285 1980_06_TY_18 Medians, Altitudes, Bisectors and Midsegments

In equilateral triangle ABC , AD and BE , the bisectors of angles A and B , respectively, intersect at point F . What is $m\angle AFB$?

- (1) 60
- (2) 90
- (3) 120
- (4) 150

286 1980_06_TY_19 Polygons: Interior and Exterior Angles of

The measure of an exterior angle of a regular polygon is 45° . What is the total number of sides of the polygon?

- (1) 9
- (2) 8
- (3) 7
- (4) 6

- 287 1980_06_TY_20 Medians, Altitudes, Bisectors and Midsegments
 In the accompanying diagram of scalene triangle ABC , median CE and altitude CD are drawn to side AB .

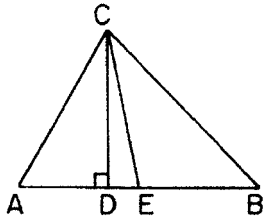

If $CE = 6$, then the length of CD could be

- (1) 8
 (2) 7
 (3) 6
 (4) 5
- 288 1980_06_TY_21 Logical Reasoning: Converse
 What is the converse of the statement, "If it has green horns, then it is a fizzgig"?
- (1) No fizzgig has green horns.
 (2) If it is a fizzgig, then it has green horns.
 (3) If it is not a fizzgig, then it does not have green horns.
 (4) If it does not have green horns, then it is a fizzgig.

- 289 1980_06_TY_22 Triangles: Mean Proportionals
 The altitude drawn to the hypotenuse of a right triangle divides the hypotenuse into two segments of lengths 3 and 12. What is the length of this altitude?
- (1) 36
 (2) 18
 (3) 6
 (4) 4

- 290 1980_06_TY_23 Triangles: Isosceles
 In isosceles triangle ABC , $\overline{AC} \cong \overline{BC}$ and D is a point lying between A and B on base AB . If CD is drawn, then which is true?
- (1) $AC > CD$
 (2) $CD > AC$
 (3) $m\angle A > m\angle ADC$
 (4) $m\angle B > m\angle BDC$

- 291 1980_06_TY_24 Special Quadrilaterals: Rectangles and Squares
 The area of a square whose perimeter is $8k$ is

- (1) $8k^2$
 (2) $4k\sqrt{2}$
 (3) $4k^2\sqrt{2}$
 (4) $4k^2$

- 292 1980_06_TY_25 Special Quadrilaterals: Rhombuses
 If the diagonals of a rhombus have lengths of 6 and 12, the area of the rhombus is

- (1) 72
 (2) 36
 (3) 30
 (4) 18

- 293 1980_06_TY_26 Triangles: Special Right
 In the accompanying figure, altitude FG is drawn in triangle DEF . If $DE = 8$, $DG = 4$, and $m\angle E = 60^\circ$, what is the length of \overline{EF} ?

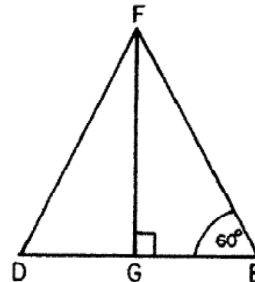

- (1) $\frac{8\sqrt{3}}{3}$
 (2) $8\sqrt{3}$
 (3) 8
 (4) $4\sqrt{3}$

- 294 1980_06_TY_27 Medians, Altitudes, Bisectors and Midsegments
 The lengths of the bases of a trapezoid are represented by $x + 2$ and $3x - 8$. In terms of x , the length of the median of the trapezoid is

- (1) $x - 10$
 (2) $2x - 3$
 (3) $4x - 6$
 (4) $4x - 10$

295 1980_06_TY_28 Parallel and Perpendicular Lines
Which line is parallel to the line $y = 2x + 4$?

- (1) $y = 2x + 6$
- (2) $y = 4 - 2x$
- (3) $y = 4x - 2$
- (4) $2y = x - 2$

296 1980_06_TY_29 Proofs: Triangle
In the accompanying diagram, \overline{AB} and \overline{CD} intersect at E and $\angle A \cong \angle B$. Which additional information is needed to show that $\triangle ACE \cong \triangle DBE$?

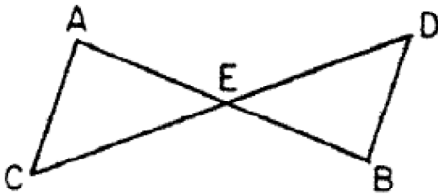

- (1) $\overline{AC} \cong \overline{BD}$
- (2) $\overline{AB} \cong \overline{CD}$
- (3) $\overline{AC} \parallel \overline{BD}$
- (4) $\angle C \cong \angle D$

297 1980_06_TY_30 Constructions
On the answer sheet, construct an equilateral triangle with one vertex at A.

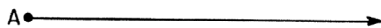

298 1980_06_TY_31a Proofs: Triangle
Prove:
The sum of the measures of the angles of a triangle is 180 degrees, [10]

299 1980_06_TY_31b Special Quadrilaterals: Parallelograms
Prove:
The area of a parallelogram is equal to the product of the length of one side and the length of the altitude drawn to that side. [10]

300 1980_06_TY_32 Proofs: Circle
Given: circle O , chords \overline{AG} , \overline{BD} , \overline{BC} , \overline{CD} , and \overline{AB} ,
 $\overline{AC} \cong \overline{BD}$.

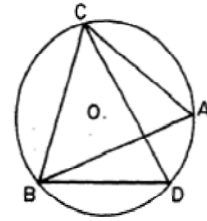

Prove: $\triangle CAB \cong \triangle BDC$ [10]

301 1980_06_TY_33 Locus
Points R and S are 4 units apart.

- a. Describe fully the locus of points equidistant from R and S . [3]
- b. Describe fully the locus of points d units from S . [3]
- c. How many points satisfy the conditions in parts a and b simultaneously for the following values of d ?
 - (1) $d = 4$ [2]
 - (2) $d = 2$ [2]

302 1980_06_TY_34 Circles: Chords, Secants and Tangents
In circle O , diameter \overline{AB} is extended to point C , \overline{CD} is tangent to the circle at D , diameter \overline{DE} has length 20, and $m\widehat{BD} : m\widehat{AD} = 1 : 4$. Chords \overline{AE} and \overline{AD} are drawn.

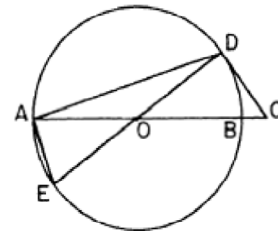

Find:

- a. $m\widehat{BD}$ [2]
- b. $m\angle E$ [2]
- c. $m\angle C$ [2]
- d. CD to the nearest tenth. [4]

- 303 1980_06_TY_35 Proofs: Coordinate
 The vertices of quadrilateral $ABCD$ are $A(3,2)$, $B(7,4)$, $C(9,8)$, and $D(5,6)$.
 Show by means of coordinate geometry, and state reasons for your conclusions:
- AC and BD bisect each other [6]
 - $ABCD$ is a rhombus [4]

- 304 1980_06_TY_36 Proofs: Triangle
 Prove: An altitude of an acute scalene triangle can *not* bisect the angle from whose vertex it is drawn. [10]

- 305 1980_06_TY_37 Slope
 Given: points $A(1, -1)$, $B(5,7)$, $C(0,4)$, and $D(3, k)$,
- Find the slope of AB . [2]
 - Express the slope of CD in terms of k [3]
 - If $AB \parallel CD$, find k . [2]
 - Write an equation of CD . [3]

*This question is based on an optional topic in the syllabus.

- 306 1980_08_TY_01 Medians, Altitudes, Bisectors and Midsegments
 In the accompanying figure, the length of a side of equilateral triangle ABC is 10. If D , E , and F are the midpoints of sides AC , CB , and AB , respectively, find the perimeter of triangle DEF .

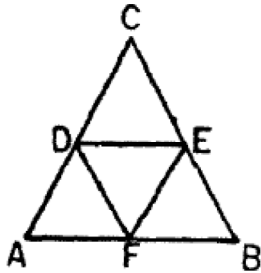

- 307 1980_08_TY_02 Polygons: Interior and Exterior Angles of
 The sum of the measures of three angles of a quadrilateral is 275° . Find the number of degrees in the measure of the fourth angle.

- 308 1980_08_TY_03 Similarity
 A triangle has sides of lengths 4 meters, 5 meters, and 7 meters. The perimeter of a second triangle similar to the first triangle is 32 meters. What is the length in meters of the *longest* side of the second triangle?

- 309 1980_08_TY_04 Special Quadrilaterals: Parallelograms
 In parallelogram $ABCD$, the measure of angle B is 5 times the measure of angle A . Find the number of degrees in the measure of angle A .

- 310 1980_08_TY_05 Circles: Tangents
 As shown in the accompanying diagram, triangle XYZ is circumscribed about circle O .

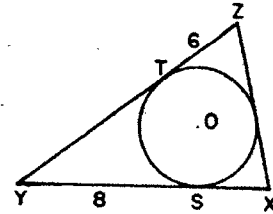

If points S and T are points of tangency such that $TZ = 6$ and $SY = 8$, find YZ .

- 311 1980_08_TY_06 Similarity
 In the accompanying diagram, $\overline{EF} \parallel \overline{BC}$, $AE = 6$, $EB = 2$, and $AC = 12$. Find AF .

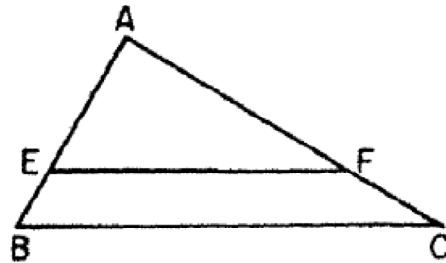

- 312 1980_08_TY_07 Polygons: Interior and Exterior Angles of
 If the measure of each exterior angle of a regular polygon is 40° , how many sides does the polygon have?

- 313 1980_08_TY_08 Midpoint
 The coordinates of the endpoints of line segment \overline{AB} are $A(-2,6)$ and $B(4,8)$. What are the coordinates of the midpoint of \overline{AB} ?

- 314 1980_08_TY_09 Polygons: Area of
As shown in the accompanying diagram of trapezoid $ABCD$, $AB \perp BC$, $DC \perp BC$, $AB = 3$, $BC = 8$, $DC = 5$. What is the area of trapezoid $ABCD$?

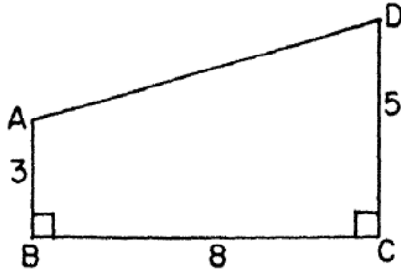

- 315 1980_08_TY_10 Circles: Arc Measure
In circle O , a central angle measuring 60° intercepts an arc 2π centimeters in length. Express in terms of π the number of centimeters in the circumference of the circle.

- 316 1980_08_TY_11 Trigonometry: Finding Sides
The top of a ladder 30 feet long is placed against a vertical wall. The base of the ladder forms an angle measuring 66° with the horizontal ground. Find, to the nearest foot, the distance from the base of the ladder to the base of the wall.

- 321 1980_08_TY_16 Graphic Representation
In which diagram does $AB + BC - AC = 0$?

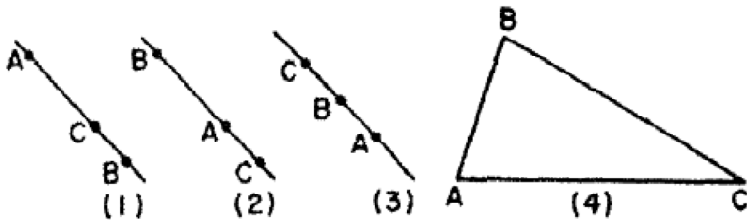

- 317 1980_08_TY_12 Slope
What is the slope of the line that contains the points $(3,5)$ and $(9,8)$?
- 318 1980_08_TY_13 Triangles: Equilateral
If an equilateral triangle has a side of length 8, what is the length of an altitude of the triangle?
- 319 1980_08_TY_14 Polygons: Area of
The perimeter of a regular polygon is 40, and the length of its apothem is 5. Find the area of the polygon.
- 320 1980_08_TY_15 Triangles: Interior and Exterior Angles of
In a right triangle, the measures in degrees of the acute angles are $4x$ and $5x$. What is the value of x ?
- (1) 10
 - (2) 20
 - (3) 30
 - (4) 40

- 322 1980_08_TY_17 Logical Reasoning: Converse
 What is the converse of the statement, "If two parallel lines are cut by a transversal, the alternate interior angles are congruent"?
- (1) If two parallel lines are cut by a transversal, the corresponding angles are congruent.
 - (2) If two lines are cut by a transversal so that the alternate interior angles are congruent, the lines are parallel.
 - (3) If two parallel lines are cut by a transversal, the alternate exterior angles are not congruent.
 - (4) If two nonparallel lines are cut by a transversal, the alternate interior angles are not congruent.

- 323 1980_08_TY_18 Circles: Chords

As shown in the accompanying diagram, chords \overline{AB} and \overline{CD} of circle O intersect at E .

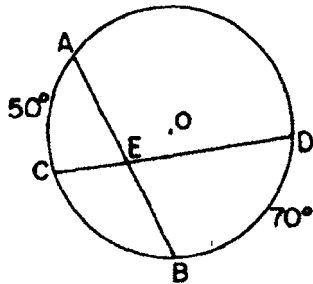

If $m\widehat{AC} = 50$ and $m\widehat{BD} = 70$, what is $m\angle AEC$?

- (1) 10
 - (2) 20
 - (3) 60
 - (4) 120
- 324 1980_08_TY_19 Locus
 A circle whose radius is 8 has its center at the origin. The point whose coordinates are (5,5) must lie
- (1) outside the circle
 - (2) inside the circle but not at its center
 - (3) on the circle
 - (4) at the center of the circle

- 325 1980_08_TY_20 Medians, Altitudes, Bisectors and Midsegments
 In triangle ABC , if median AD is perpendicular to side BC , then triangle ABC must be
- (1) obtuse
 - (2) acute
 - (3) scalene
 - (4) isosceles

- 326 1980_08_TY_21 Triangle Inequalities
 Which set of numbers can *not* be the lengths of the sides of a right triangle?
- (1) {5,17,18}
 - (2) {5,12, 13}
 - (3) {3,4,5}
 - (4) {6,8,10}

- 327 1980_08_TY_22 Circles: Area of
 If the circumference of a circle is 12π , the area of the circle is
- (1) 6π
 - (2) 12π
 - (3) 24π
 - (4) 36π

- 328 1980_08_TY_23 Circles: Chords, Secants and Tangents
 In the accompanying diagram, \overline{AB} is tangent to the circle at B and \overline{ACD} is a secant.

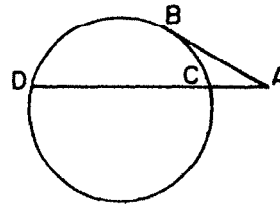

- If $AD = 12$ and $AC = 3$, the length of \overline{AB} is
- (1) 6
 - (2) 9
 - (3) 15
 - (4) 36
- 329 1980_08_TY_24 Medians, Altitudes, Bisectors and Midsegments
 If the perpendicular bisectors of the sides of a triangle all meet at a point outside the triangle, the triangle *must* be
- (1) acute
 - (2) right
 - (3) obtuse
 - (4) equilateral

- 330 1980_08_TY_25 Locus
 Lines l_1 and l_2 are parallel and 4 units apart. Point P lies on line l_1 . What is the locus of points at a distance 3 units from P and also equally distant from l_1 and l_2 ?
- (1) one point
 - (2) two points
 - (3) one line
 - (4) two lines

- 331 1980_08_TY_26 Triangles: Mean Proportionals
 In the accompanying diagram of right triangle ABC , altitude CD is drawn to hypotenuse AB .

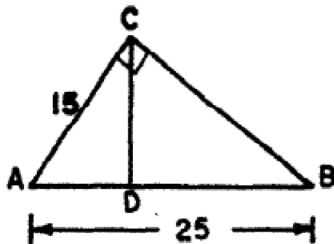

If $AB = 25$ and $AC = 15$, then AD is equal to

- (1) $1\frac{2}{3}$
 - (2) 5
 - (3) 3
 - (4) 9
- 332 1980_08_TY_27 Parallel Lines: Angles Involving
 Two parallel lines are cut by a transversal so that two interior angles on the same side of the transversal have measures of X° and $(2x-15)^\circ$. What is the value of x ?
- (1) 65
 - (2) 55
 - (3) 50
 - (4) 45

- 333 1980_08_TY_28 Locus with Equations
 Which is an equation of the locus of points that are equidistant from the points $(4,2)$ and $(8,2)$?
- (1) $x = 6$
 - (2) $y = 6$
 - (3) $x = 12$
 - (4) $y = 12$

- 334 1980_08_TY_29 Polygons and Circles: Inscribed
 A square is inscribed in a circle whose diameter has length 10. The area of the square is
- (1) 12.5
 - (2) 25
 - (3) 50
 - (4) 100

- 335 1980_08_TY_30 Constructions
 On the answer sheet, locate by construction the center of the given circle.

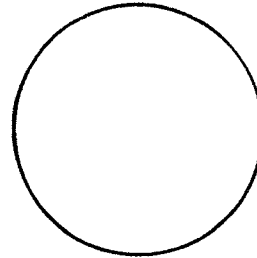

- 336 1980_08_TY_31a Proofs: Circle
 Prove
 The measure of an angle formed by a tangent and a secant is equal to one-half the difference of the measures of the intercepted arcs. [10]

- 337 1980_08_TY_31b Proofs: Triangle
 Prove
 The area of a triangle is equal to one-half the product of the length of a side and the length of the altitude drawn to that side. [10]

- 338 1980_08_TY_32 Proofs: Triangle
 Given: \overline{ADB} , \overline{AEC} , \overline{BFE} , \overline{CFD} , $AB \cong AC$,
 $AD \cong AE$.

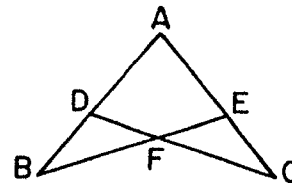

- Prove:
 a $\angle B \cong \angle C$ [4]
 b $\overline{DF} \cong \overline{EF}$

339 1980_08_TY_33 Proofs: Circle

Given: isosceles triangle ABC inscribed in circle O with $AC \cong BC$. Chords CD and AB intersect at E . Chord AD is drawn.

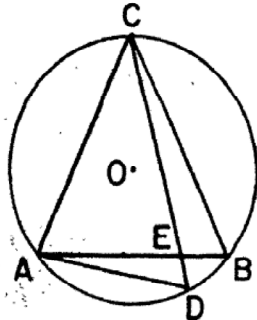

Prove: a $\angle CAD \cong \angle CEA$ [5]
 b $(AC)^2 = CE \times CD$ [5]

340 1980_08_TY_33 Proofs: Triangle

Given: \overline{ADB} , \overline{AEC} , \overline{BFE} , \overline{CFD} , $AB \cong AC$, $AD \cong AE$.

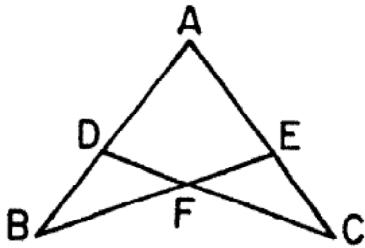

Prove: a $\angle B \cong \angle C$ [4]
 b $DF \cong EF$ [6]

341 1980_08_TY_34 Proofs: Coordinate

The coordinates of the vertices of quadrilateral $ABCD$ are $A(2,0)$, $B(10,2)$, $C(6,1)$, and $D(2,6)$.

a Show by coordinate geometry that $AB \perp CD$ and state a reason for your conclusion. [5]
 b Show by coordinate geometry that quadrilateral $ABCD$ is *not* a parallelogram and state a reason for your conclusion. [5]

342 1980_08_TY_35 Circles: Chords, Secants and Tangents

In the accompanying diagram, \overline{AB} is tangent to circle O at B , \overline{ACD} , \overline{BD} is a diameter, $m\widehat{BC} : m\widehat{CD} = 3 : 2$.

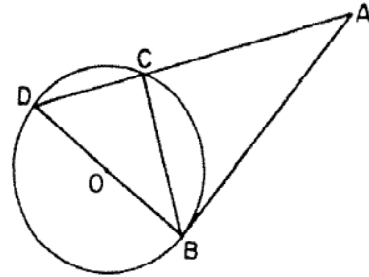

Find: a $m\widehat{BC}$ [2]
 b $m\angle CBA$ [2]
 c $m\angle CBD$ [2]
 d $m\angle A$ [2]
 e $m\angle ACB$ [2]

343 1980_08_TY_36 Special Quadrilaterals: Rhombuses

In rhombus $ABCD$, the length of each side is 20 and the measure of $\angle DAB$ is 74° , Diagonals \overline{AC} and \overline{BD} intersect at E .

a Find AC to the nearest integer. [4]
 b Find BD to the nearest integer. [4]
 c Using your results from parts a and b, find the area of the rhombus. [2]

344 1980_08_TY_37 Proofs: Polygon

Given: Quadrilateral $ABCD$ with diagonals \overline{AC} and \overline{BD} .

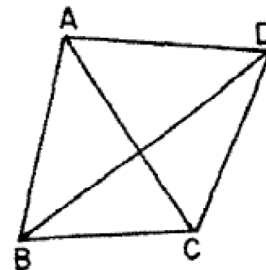

Prove: $AB + 2(BC) + CD > AC + BD$ [10]