

The University of the State of New York

REGENTS HIGH SCHOOL EXAMINATION

MATHEMATICS A

Friday, June 15, 2001 — 1:15 to 4:15 p.m., only

Print Your Name:

Steve Watson

Print Your School's Name:

IHS @ PH

Print your name and the name of your school in the boxes above. Then turn to the last page of this booklet, which is the answer sheet for Part I. Fold the last page along the perforations and, slowly and carefully, tear off the answer sheet. Then fill in the heading of your answer sheet.

Scrap paper is not permitted for any part of this examination, but you may use the blank spaces in this booklet as scrap paper. A perforated sheet of scrap graph paper is provided at the end of this booklet for any question for which graphing may be helpful but is not required. Any work done on this sheet of scrap graph paper will not be scored. All work should be written in pen, except graphs and drawings, which should be done in pencil.

This examination has four parts, with a total of 35 questions. You must answer all questions in this examination. Write your answers to the Part I multiple-choice questions on the separate answer sheet. Write your answers to the questions in Parts II, III, and IV directly in this booklet. Clearly indicate the necessary steps you take, including appropriate formula substitutions, diagrams, graphs, charts, etc.

When you have completed the examination, you must sign the statement printed at the end of the answer sheet, indicating that you had no unlawful knowledge of the questions or answers prior to the examination and that you have neither given nor received assistance in answering any of the questions during the examination. Your answer sheet cannot be accepted if you fail to sign this declaration.

Notice...

A minimum of a scientific calculator, a straightedge (ruler), and a compass must be available for your use while taking this examination.

DO NOT OPEN THIS EXAMINATION BOOKLET UNTIL THE SIGNAL IS GIVEN.

Part I

Answer all questions in this part. Each correct answer will receive 2 credits. No partial credit will be allowed. Record your answers in the spaces provided on the separate answer sheet. [40]

1 A car travels 110 miles in 2 hours. At the same rate of speed, how far will the car travel in h hours?

(1) $55h$

(2) $220h$

(3) $\frac{h}{55}$

(4) $\frac{h}{220}$

speed = $\frac{\text{distance}}{\text{time}}$

speed = $\frac{110 \text{ miles}}{2 \text{ hours}} = \frac{55 \text{ miles}}{1 \text{ hour}} = 55$

Use this space for computations.

speed = $\frac{\text{distance}}{\text{time}}$
 distance = speed (time)
 distance = $55h$

2 Which polynomial is the quotient of $\frac{6x^3 + 9x^2 + 3x}{3x}$?

(1) $2x^2 + 3x + 1$

(2) $2x^2 + 3x$

(3) $2x + 3$

(4) $6x^2 + 9x$

$\frac{6x^3}{3x} + \frac{9x^2}{3x} + \frac{3x}{3x}$
 $2x^2 + 3x + 1$

3 If the length of a rectangular prism is doubled, its width is tripled, and its height remains the same, what is the volume of the new rectangular prism?

(1) double the original volume

(2) triple the original volume

(3) six times the original volume

(4) nine times the original volume

$V = lwh$

$V' = (2l)(3w)h$

$V' = (2)(3)(l)(w)(h)$

$V' = 6lwh$

4 One root of the equation $2x^2 - x - 15 = 0$ is

(1) $\frac{5}{2}$

(2) $\frac{3}{2}$

(3) 3

(4) -3

$(2x+5)(x-3) = 0$
 $2x^2 - 6x + 5x - 15 = 0$
 $\checkmark 2x^2 - x - 15 = 0$

$2x+5=0$
 $2x = -5$
 $x = \frac{-5}{2}$

$x-3=0$
 $x = 3$

5 Which properties best describe the coordinate graph of two distinct parallel lines?

(1) same slopes and same intercepts

(2) same slopes and different intercepts

(3) different slopes and same intercepts

(4) different slopes and different intercepts

— same line

— not parallel
 — not parallel

6 Which statement is *not* always true about a parallelogram?

Use this space for computations.

- (1) The diagonals are congruent.
- (2) The opposite sides are congruent. True
- (3) The opposite angles are congruent. True
- (4) The opposite sides are parallel. True



7 In isosceles triangle DOG , the measure of the vertex angle is three times the measure of one of the base angles. Which statement about $\triangle DOG$ is true?

- (1) $\triangle DOG$ is a scalene triangle.
- (2) $\triangle DOG$ is an acute triangle.
- (3) $\triangle DOG$ is a right triangle.
- (4) $\triangle DOG$ is an obtuse triangle.

$$3x + x + x = 180^\circ$$

$$5x = 180$$

$$x = 36^\circ$$

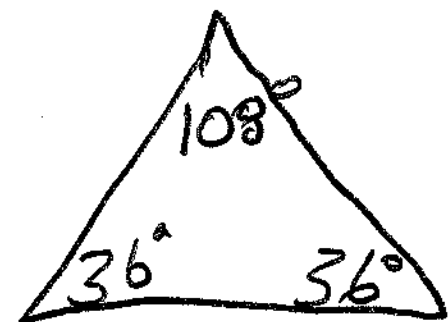
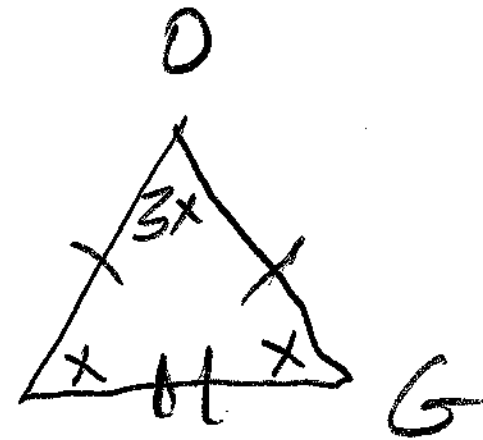

8 Which equation illustrates the distributive property for real numbers?

(1) $\frac{1}{3} + \frac{1}{2} = \frac{1}{2} + \frac{1}{3}$ Commutative Prop. of Addition

(2) $\sqrt{3} + 0 = \sqrt{3}$ Additive Identity

(3) $(1.3 \times 0.07) \times 0.63 = 1.3 \times (0.07 \times 0.63)$ Commutative Property of Multiplication

(4) $-3(5 + 7) = (-3)(5) + (-3)(7)$

9 Factor completely: $3x^2 - 27$

(1) $3(x - 3)^2$

(2) $3(x^2 - 27)$

(3) $3(x + 3)(x - 3)$

(4) $(3x + 3)(x - 9)$

$$3(x^2) - 3(9)$$

$$3(x^2 - 9)$$

$$3(x + 3)(x - 3)$$

10 At a school costume party, seven girls wore masks and nine boys did not. If there were 15 boys at the party and 20 students did not wear masks, what was the total number of students at the party?

(1) 30

(2) 33

(3) 35

(4) 42

	Masks	No Masks	Totals
Boys		9	15
Girls	7		
Totals		20	

	Masks	No Masks	Totals
Boys	6	9	15
Girls	7	11	18
Totals	13	20	33

Step #1
Make a table
and fill in the
cells using info
from the problem.

Step #2
Fill in the blanks
and answer the
question

$$\frac{1}{2} \times N = -8 + \frac{2}{3} \times N$$

11 If one-half of a number is 8 less than two-thirds of the number, what is the number?

- (1) 24
(2) 32

- (3) 48
(4) 54

Use this space for computations.

$$\begin{array}{r} \frac{1}{2}N = -8 + \frac{2}{3}N \\ -\frac{1}{2}N \quad \quad -\frac{1}{2}N \\ \hline 0 = -8 + \frac{1}{3}N \end{array} \quad \begin{array}{l} \rightarrow 8 = \frac{1}{3}N \\ \rightarrow 48 = N \end{array}$$

12 Which statement is logically equivalent to "If I eat, then I live"?

- (1) If I live, then I eat.
(2) If I eat, then I do not live.
(3) I live if and only if I eat.
(4) If I do not live, then I do not eat.

contrapositive
if I eat, then I live
Given If 1, then 2
→ If not 2, then not 1
If I do not live, then I do not eat.

13 If a is an odd number, b an even number, and c an odd number, which expression will always be equivalent to an odd number?

(1) $a(bc)$

(3) $ac(b)^1$

(2) $ac(b)^0$

(4) $ac(b)^2$

(O)(O)(E)
(O)(O)(O)

$b^0 = 1 = \text{odd}$

(odd)(odd) = odd

(odd)(even) = even

14 If there are four teams in a league, how many games will have to be played so that each team plays every other team once?

- (1) 6
(2) 8

- (3) 3
(4) 16

$${}_4C_2 = \frac{4 \cdot 3}{2 \cdot 1} = \frac{12}{2} = 6$$

15 A woman has a ladder that is 13 feet long. If she sets the base of the ladder on level ground 5 feet from the side of a house, how many feet above the ground will the top of the ladder be when it rests against the house?

- (1) 8
(2) 9

- (3) 11
(4) 12

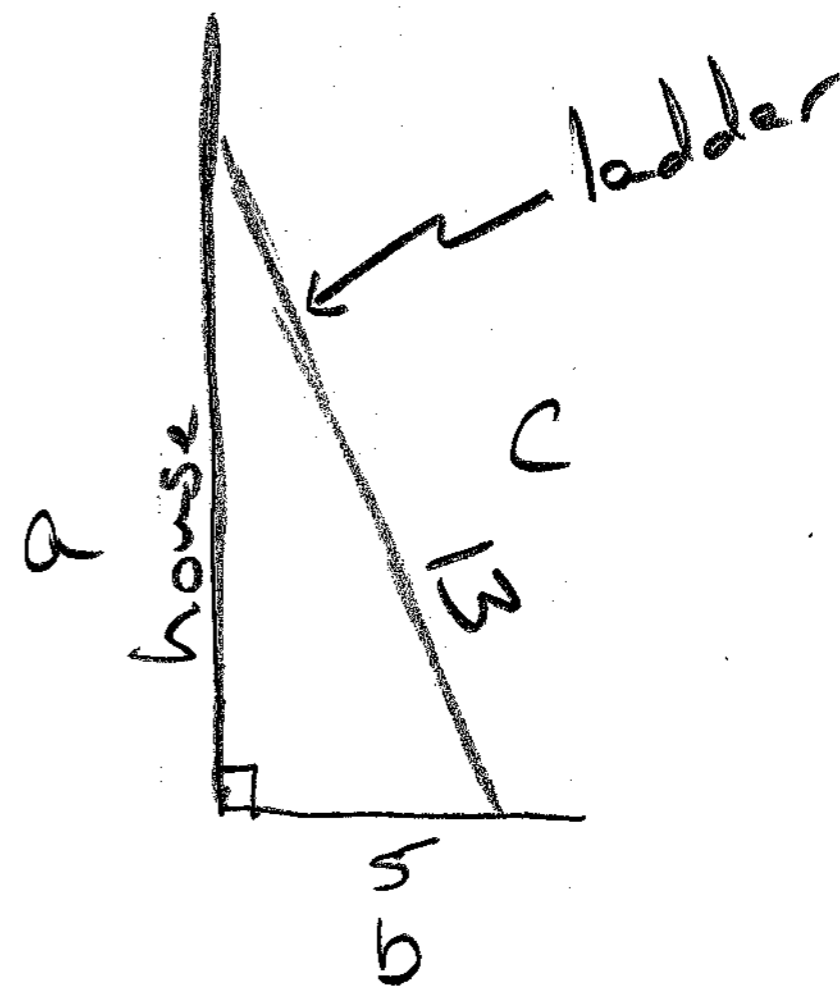

Pythagorean Theorem

$$a^2 + b^2 = c^2$$

$$a^2 + (5)^2 = (13)^2$$

$$\begin{array}{r} a^2 + 25 = 169 \\ -25 \quad \quad -25 \\ \hline a^2 = 144 \end{array}$$

$$a^2 = 144$$

$$a = 12$$

16 A boy got 50% of the questions on a test correct. If he had 10 questions correct out of the first 12, and $\frac{1}{4}$ of the remaining questions correct, how many questions were on the test?

- (1) 16 (2) 24 (3) 26 (4) 28

$$10 + \frac{1}{4}(N-12) = \frac{1}{2}N$$

$$10 + \frac{1}{4}N - 3 = \frac{1}{2}N$$

$$40 + N - 12 = 2N$$

$$28 = N$$

17 A hotel charges \$20 for the use of its dining room and \$2.50 a plate for each dinner. An association gives a dinner and charges \$3 a plate but invites four nonpaying guests. If each person has one plate, how many paying persons must attend for the association to collect the exact amount needed to pay the hotel?

- (1) 60 (2) 44 (3) 40 (4) 20

$$\text{Expenses} = 20 + 2\frac{1}{2}P + 4(2\frac{1}{2})$$

$$\text{Income} = 3P$$

$$\text{Expense} = \text{Income}$$

$$20 + 2\frac{1}{2}P + 10 = 3P$$

$$30 + 2\frac{1}{2}P = 3P$$

$$-2\frac{1}{2}P \quad -2\frac{1}{2}P$$

$$30 = \frac{1}{2}P$$

$$60 = P$$

18 In the set of positive integers, what is the solution set of the inequality $2x - 3 < 5$?

- (1) {0,1,2,3} (2) {1,2,3} (3) {0,1,2,3,4} (4) {1,2,3,4}

$$\begin{array}{r} 2x - 3 < 5 \\ +3 \quad +3 \\ \hline 2x < 8 \\ x < 4 \end{array}$$

zero is not a positive integer

19 What is the total number of points of intersection in the graphs of the equations $x^2 + y^2 = 16$ and $y = 4$?

- (1) 1 (2) 2 (3) 3 (4) 0

x	$x^2 + y^2 = 16$	y
0	$(0)^2 + y^2 = 16$	± 4
	$y = \pm 4$	± 4
	$x^2 + (0)^2 = 16$	0
± 4	$x^2 = 16$	
	$x = \pm 4$	

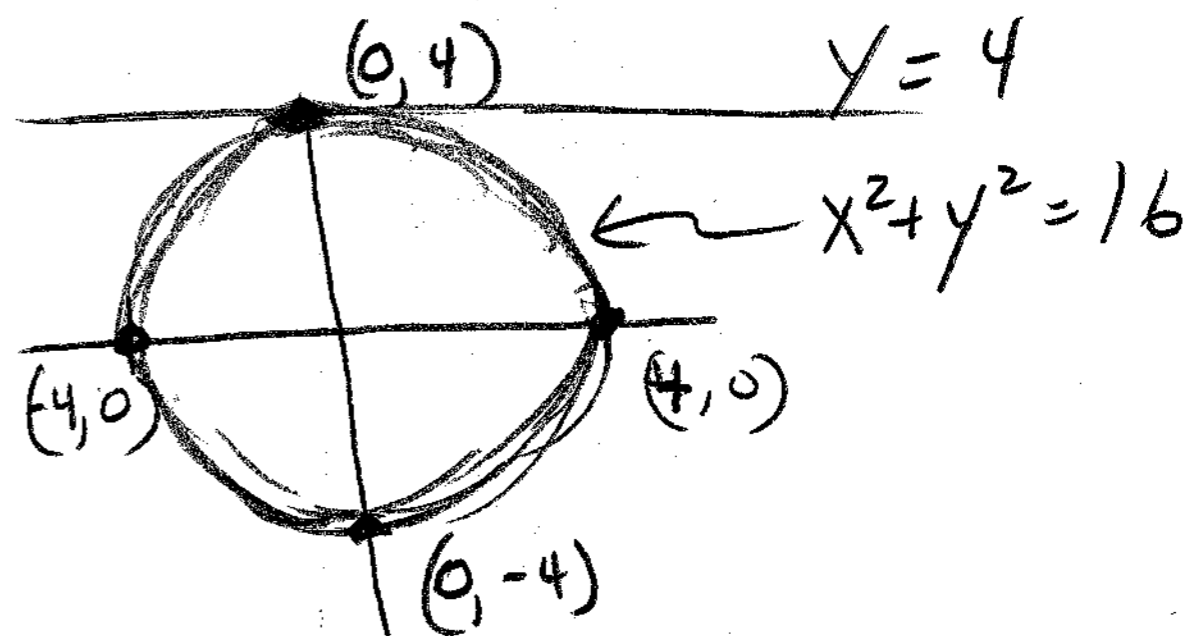

20 Which is a rational number?

- (1) $\sqrt{8}$ (2) π (3) $5\sqrt{9}$ (4) $6\sqrt{2}$

$$\sqrt{8} \Rightarrow 2\sqrt{2} \text{ irrational}$$

$$\pi \Rightarrow \text{irrational}$$

$$5\sqrt{9} \Rightarrow 5\sqrt{3}\sqrt{3} \Rightarrow 5 \cdot 3 = 15 = \frac{15}{1} \text{ rational}$$

$$6\sqrt{2} \Rightarrow \text{irrational}$$

Part II

Answer all questions in this part. Each correct answer will receive 2 credits. Clearly indicate the necessary steps, including appropriate formula substitutions, diagrams, graphs, charts, etc. For all questions in this part, a correct numerical answer with no work shown will receive only 1 credit. [10]

21 A school district offers hockey and basketball. The result of a survey of 300 students showed:

- 120 students play hockey, only
- 90 students play basketball, only
- 30 students do not participate in either sport

Of those surveyed, how many students play both hockey and basketball?

Solution #1

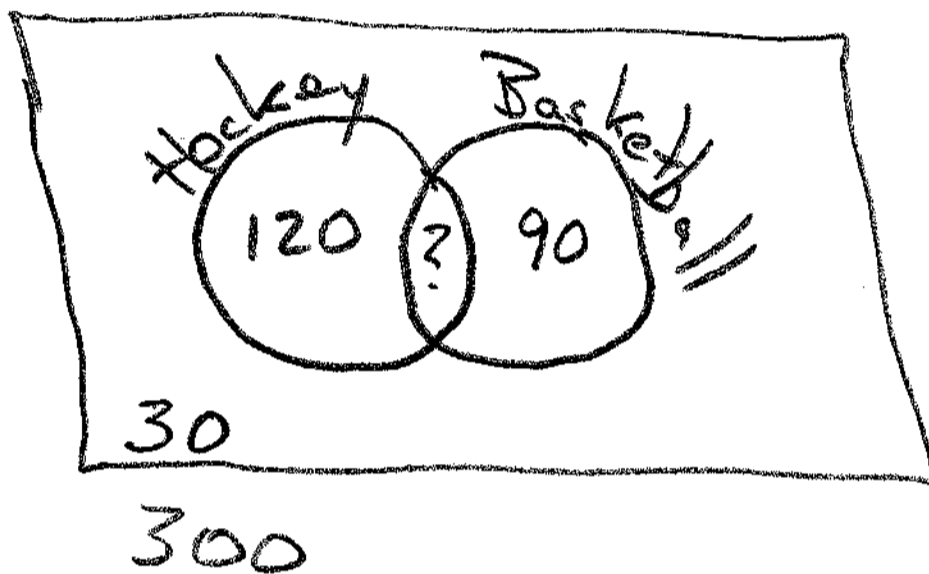

$$120 + ? + 90 + 30 = 300$$

$$240 + ? = 300$$

$$\begin{array}{r} -240 \\ \hline \end{array}$$

$$? = 60$$

Answer

60 play both

Solution #2

	B-ball	Not B-ball	Total
Hockey	60	60 120	180
Not Hockey	90	30	120
Total	150	150	300

Answer

60 play both basketball + hockey

- 22 In the accompanying diagram, parallel lines \overline{AB} and \overline{CD} are intersected by transversal \overline{EF} at points X and Y, and $m\angle FYD = 123$. Find $m\angle AXY$.

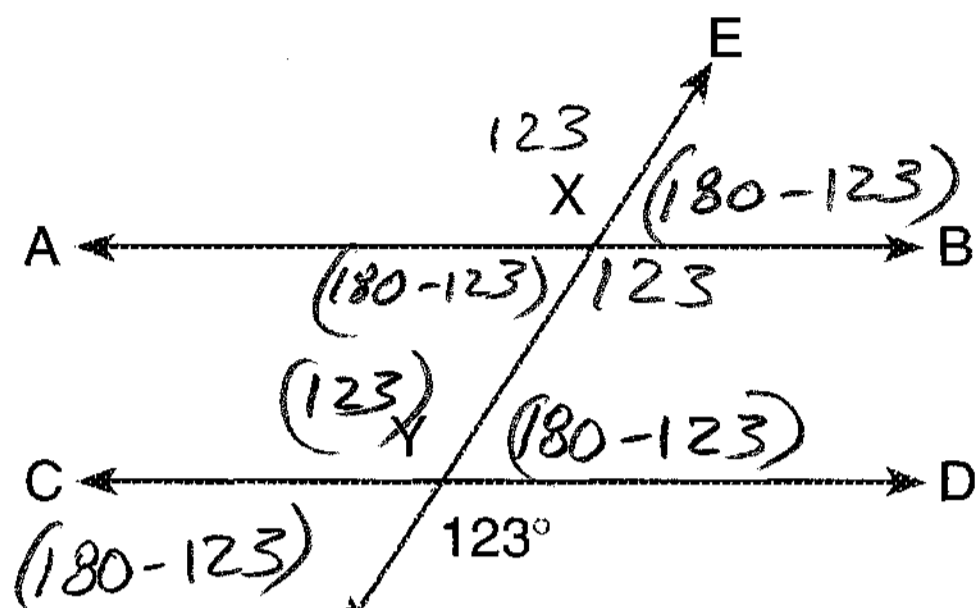

$$m\angle AXY = (180^\circ - 123^\circ) = \boxed{57^\circ}$$

- 23 Ben had twice as many nickels as dimes. Altogether, Ben had \$4.20. How many nickels *and* how many dimes did Ben have?

Let $n = \#$ of nickels
Let $d = \#$ of dimes

$$n = 2d$$

$$.05n + .10d = 4.20$$

$$5(n) + 10d = 420$$

$$5(2d) + 10d = 420$$

$$10d + 10d = 420$$

$$20d = 420$$

$$d = 21$$

$$21 \text{ dimes} = 2.10$$

$$42 \text{ nickels} = \underline{2.10}$$

$$\text{total} = 4.20$$

Answer

Ben had
21 dimes
and
42 nickels

$$n = 2d$$

$$n = 2(21)$$

$$n = 42$$

24 If a girl 1.2 meters tall casts a shadow 2 meters long, how many meters tall is a tree that casts a shadow 75 meters long at the same time?

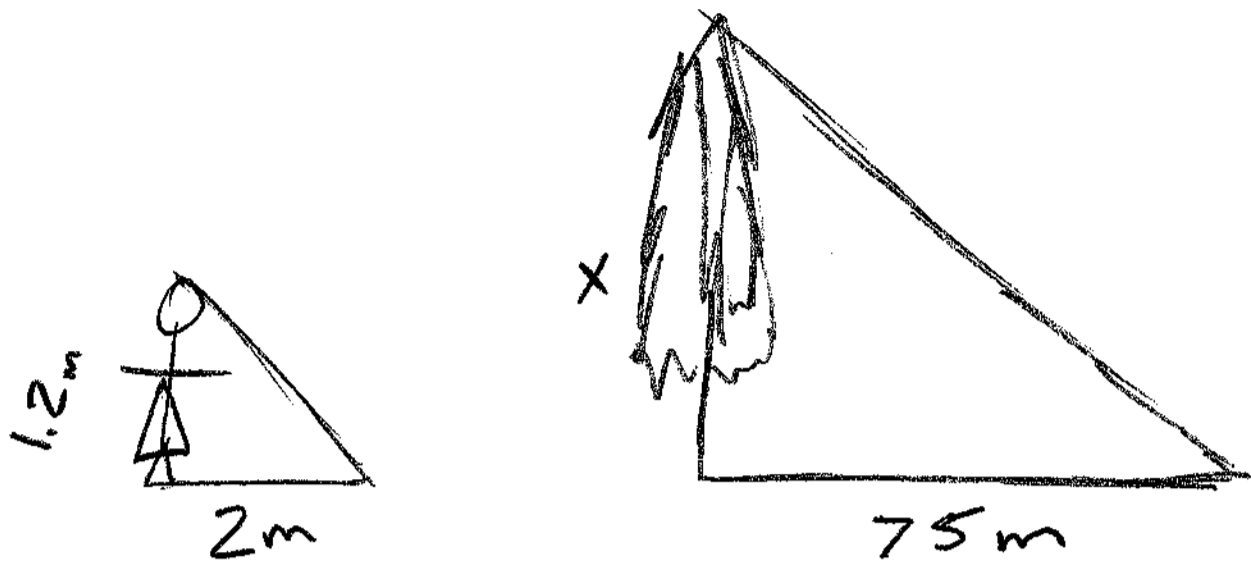

Ratio $\Rightarrow \frac{\text{height}}{\text{shadow}}$

$$\frac{\text{girl height}}{\text{girl shadow}} = \frac{\text{tree height}}{\text{tree shadow}}$$

$$\frac{1.2}{2} = \frac{x}{75}$$

$$(1.2) 75 = 2x$$

$$90 = 2x$$

$$45 = x$$

Answer
The tree is 45 meters tall

25 There were seven students running in a race. How many different arrangements of first, second, and third place are possible?

$$7 P_3$$

\rightarrow # of boxes = $\boxed{7} \cdot \boxed{6} \cdot \boxed{5} = 210$

\rightarrow # in first box \rightarrow

1st place choices 2nd Place Choices 3rd Place Choices

Answer

There are 210 different arrangements.

Part III

Answer all questions in this part. Each correct answer will receive 3 credits. Clearly indicate the necessary steps, including appropriate formula substitutions, diagrams, graphs, charts, etc. For all questions in this part, a correct numerical answer with no work shown will receive only 1 credit. [15]

- 26 In the accompanying diagram of parallelogram $ABCD$, $m\angle A = (2x + 10)$ and $m\angle B = 3x$. Find the number of degrees in $m\angle B$.

Check

$$\begin{aligned} \angle A &= 78^\circ \\ \angle B &= 102^\circ \\ \angle C &= 78^\circ \\ \angle D &= 102^\circ \\ \hline &360^\circ \checkmark \end{aligned}$$

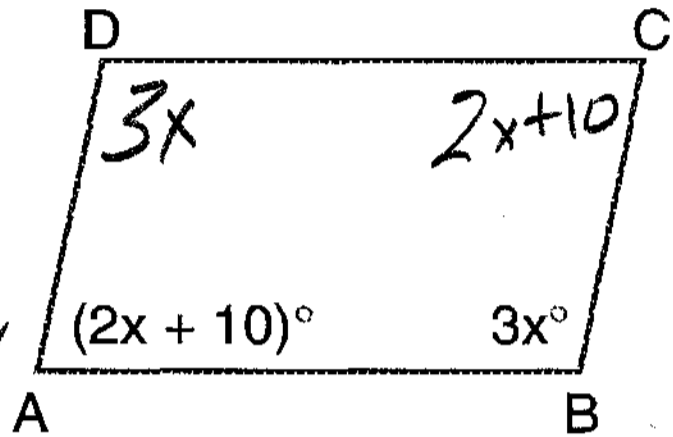

The interior \angle s of all quadrilaterals sum to 360°

Opposite \angle s in parallelogram are equal in measure.

$$(2x + 10) + (3x) + (2x + 10) + (3x) = 360^\circ$$

$$4x + 20 + 6x = 360$$

$$10x + 20 = 360$$

$$10x = 340$$

$$x = 34^\circ$$

$$m\angle B = 3x = 3(34) = 102^\circ$$

Answer

102°

- 27 A factory packs CD cases into cartons for a music company. Each carton is designed to hold 1,152 CD cases. The Quality Control Unit in the factory expects an error of less than 5% over or under the desired packing number. What is the *least* number and the *most* number of CD cases that could be packed in a carton and still be acceptable to the Quality Control Unit?

$$100\% \pm 5\% = 95\% < X < 105\%$$

$$1152 \cdot (95\%) \Rightarrow 1152 \cdot (.95) = 1094.4$$

$$1152 \cdot (105\%) \Rightarrow 1152 \cdot (1.05) = 1209.6$$

$$1094.4 < X < 1209.6$$

1095 is the least # and 1209 is the most number

28 Connor wants to compare Celsius and Fahrenheit temperatures by drawing a conversion graph. He knows that $-40^{\circ}\text{C} = -40^{\circ}\text{F}$ and that $20^{\circ}\text{C} = 68^{\circ}\text{F}$. On the accompanying grid, construct the conversion graph and, using the graph, determine the Celsius equivalent of 25°F .

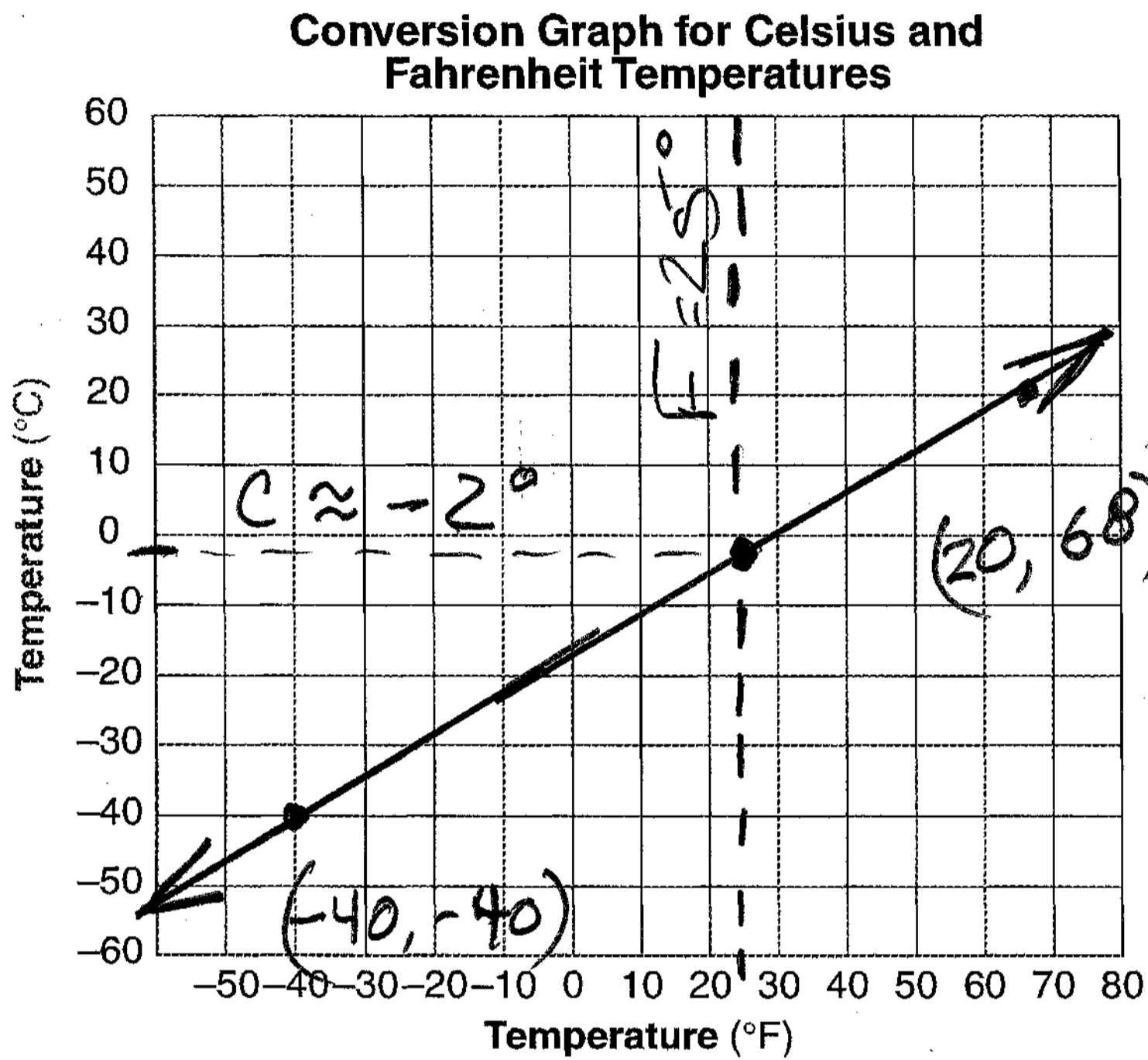

Answer

The Celsius equivalent of 25°F is approximately -3°C

- 29 Virginia has a circular rug on her square living room floor, as represented in the accompanying diagram. If her entire living room floor measures 100 square feet, what is the area of the part of the floor covered by the rug?

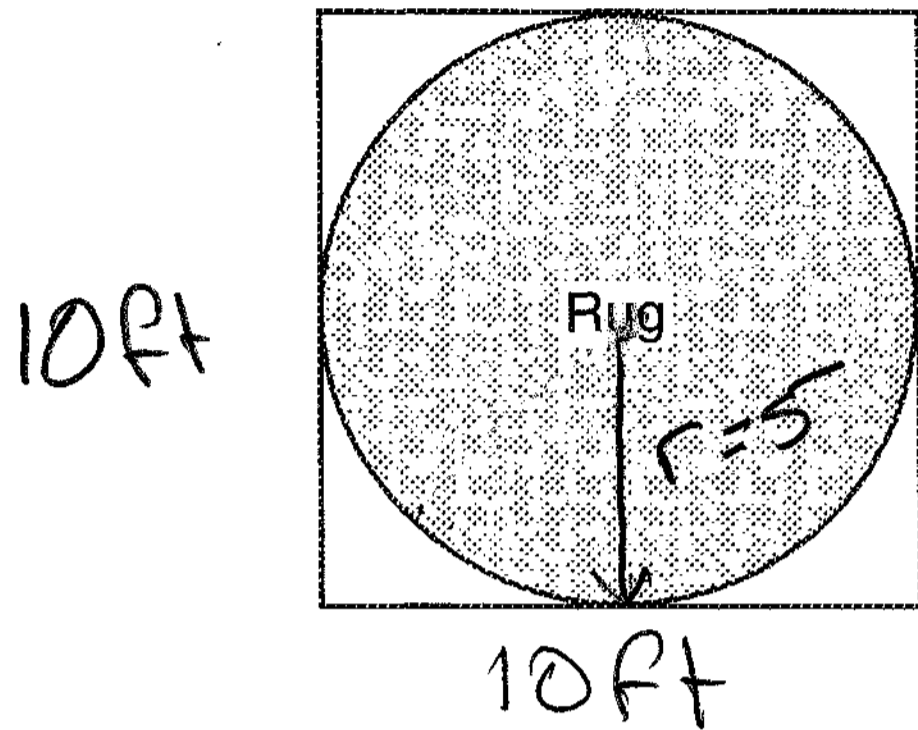

$$A_{\square} = (S)^2$$

$$100 = (S)^2$$

$$10 = S$$

Each side of the living room is 10 feet long.

$$A_{\circ} = \pi r^2$$

$$A_{\circ} = \pi (5)^2$$

$$A_{\circ} = 25\pi \text{ square feet or } 78.53981634 \text{ ft}^2$$

$$\text{or } \approx 78.5 \text{ ft}^2$$

Answer

- 30 Mr. Yee has 10 boys and 15 girls in his mathematics class. If he chooses two students at random to work on the blackboard, what is the probability that both students chosen are girls?

$$P(\text{event}) = \frac{\# \text{ times event happens}}{\# \text{ possible outcomes}}$$

$$P_{(A+B)} = P_{(A)} \cdot P_{(B)}$$

$$P(\text{1st choice is girl}) = \frac{15}{10+15} = \frac{15}{25} = \frac{3}{5}$$

$$P(\text{2nd choice is girl}) = \frac{15-1}{10+(15-1)} = \frac{14}{10+14} = \frac{14}{24} = \frac{7}{12}$$

$$P_{(A+B)} = \left(\frac{3}{5}\right) \cdot \left(\frac{7}{12}\right) = \frac{21}{60} \text{ or } \frac{7}{20} \text{ Answer}$$

Part IV

Answer all questions in this part. Each correct answer will receive 4 credits. Clearly indicate the necessary steps, including appropriate formula substitutions, diagrams, graphs, charts, etc. For all questions in this part, a correct numerical answer with no work shown will receive only 1 credit. [20]

31 Find three consecutive odd integers such that the product of the first and the second exceeds the third by 8.

Let $x = 1st$ odd integer

Let $x+2 = 2nd$ odd integer

Let $x+4 = 3rd$ odd integer

Check	
3	$(x)(x+2) = (x+4) + 8$
5	$(3)(5) = (7) + 8$
7	$15 = 15$
	✓

Product of 1st and 2nd = $(x)(x+2)$

Exceeds the 3rd by 8 = $(x+4) + 8$

$$(x)(x+2) = (x+4) + 8$$

$$x^2 + 2x = x + 12$$

$$\begin{array}{r} x^2 + 2x = x + 12 \\ -x \quad -x \\ \hline x^2 + x = 12 \\ -12 \quad -12 \\ \hline \end{array}$$

$$x^2 + x - 12 = 0$$

$$(x+4)(x-3) = 0$$

$$x+4=0 \quad x-3=0$$

$$x = -4 \quad x = 3$$

Not an odd integer
or a possible age

Odd Integer
Possible Age

The three consecutive odd integers are 3, 5, and 7

32 Keesha wants to tile the floor shown in the accompanying diagram. If each tile measures 1 foot by 1 foot and costs \$2.99, what will be the total cost, including an 8% sales tax, for tiling the floor?

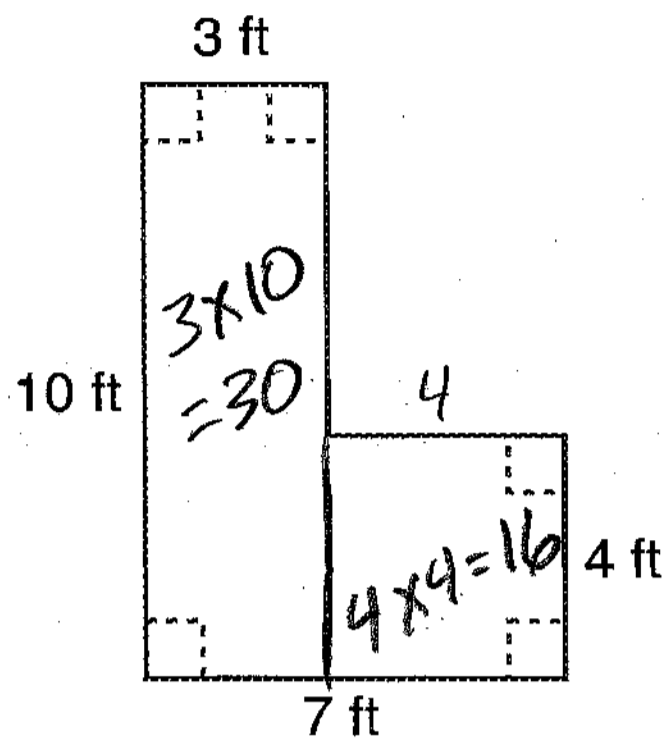

$$\begin{array}{r} 30 \text{ sq. ft} \\ 16 \text{ sq. ft} \\ \hline 46 \text{ sq. ft. total} \end{array}$$

$$(46 \text{ sq. ft.}) (2.99) = 137.54$$

$$\begin{array}{r} 137.54 \\ .08 \text{ tax} \\ \hline \$11.0032 \end{array}$$

$$\begin{array}{r} 137.54 \\ 11.00 \\ \hline \$148.54 \end{array}$$

Answer

The total cost is \$148.54

33 Ramón rented a sprayer and a generator. On his first job, he used each piece of equipment for 6 hours at a total cost of \$90. On his second job, he used the sprayer for 4 hours and the generator for 8 hours at a total cost of \$100. What was the hourly cost of each piece of equipment?

Let \star equal the # hours for the sprayer
 Let G equal the # hours for the generator

each piece of equipment for 6 hours = 90

$$6\star + 6\text{G} = 90$$

sprayer for 4 hours + generator for 8 hours = 100

$$4\star + 8\text{G} = 100$$

$$6\star + 6\text{G} = 90 \quad \text{M}(-4) \quad -24\star - 24\text{G} = -360$$

$$4\star + 8\text{G} = 100 \quad \text{M}(6) \quad 24\star + 48\text{G} = 600$$

$$24\text{G} = 240$$

$$\text{G} = 10$$

$$6\star + 6\text{G} = 90$$

$$6\star + 6(10) = 90$$

$$6\star + 60 = 90$$

$$-60 \quad -60$$

$$6\star = 30$$

$$\star = 5$$

Answer

Sprayer costs \$5⁰⁰ per hour
 Generator costs \$10⁰⁰ per hour

Check $6\star + 6\text{G} = 90$

$$6(5) + 6(10) = 90$$

$$30 + 60 = 90$$

$$90 = 90 \quad \checkmark$$

$$4\star + 8\text{G} = 100$$

$$4(5) + 8(10) = 100$$

$$20 + 80 = 100$$

$$100 = 100 \quad \checkmark$$

34 The plan of a parcel of land is represented by trapezoid $ABCD$ in the accompanying diagram. If the area of $\triangle ABE$ is 600 square feet, find the minimum number of feet of fence needed to completely enclose the entire parcel of land, $ABCD$.

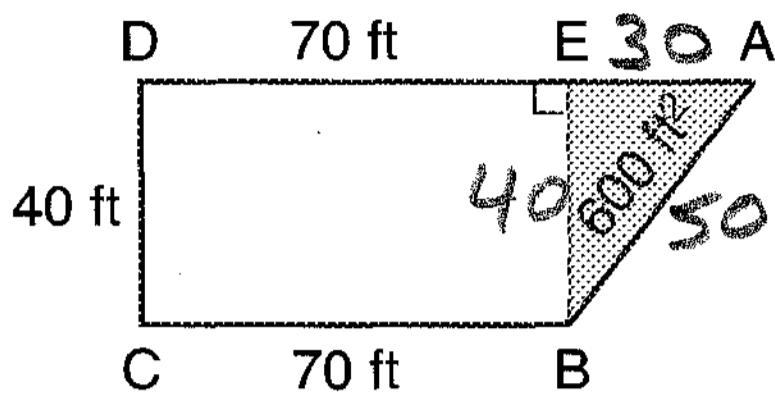

$$A_{\Delta} = \frac{1}{2} (bh)$$

$$600 = \frac{1}{2} (b)(40)$$

$$1200 = b(40)$$

$$\frac{1200}{40} = b$$

$$30 = b$$

$$\overline{DE} = 70$$

$$\overline{EA} = 30$$

$$\overline{AB} = 50$$

$$\overline{BC} = 70$$

$$\overline{DC} = 40$$

$$260$$

$$a^2 + b^2 = c^2$$

$$(\overline{AE})^2 + (\overline{EB})^2 = (\overline{AB})^2$$

$$(30)^2 + (40)^2 = (\overline{AB})^2$$

$$900 + 1600 = (\overline{AB})^2$$

$$2500 = (\overline{AB})^2$$

$$50 = \overline{AB}$$

Answer
They need 260 feet of fence to completely enclose the entire parcel of land.

35 Triangle SUN has coordinates $S(0,6)$, $U(3,5)$, and $N(3,0)$. On the accompanying grid, draw and label $\triangle SUN$. Then, graph and state the coordinates of $\triangle S'U'N'$, the image of $\triangle SUN$ after a reflection in the y -axis.

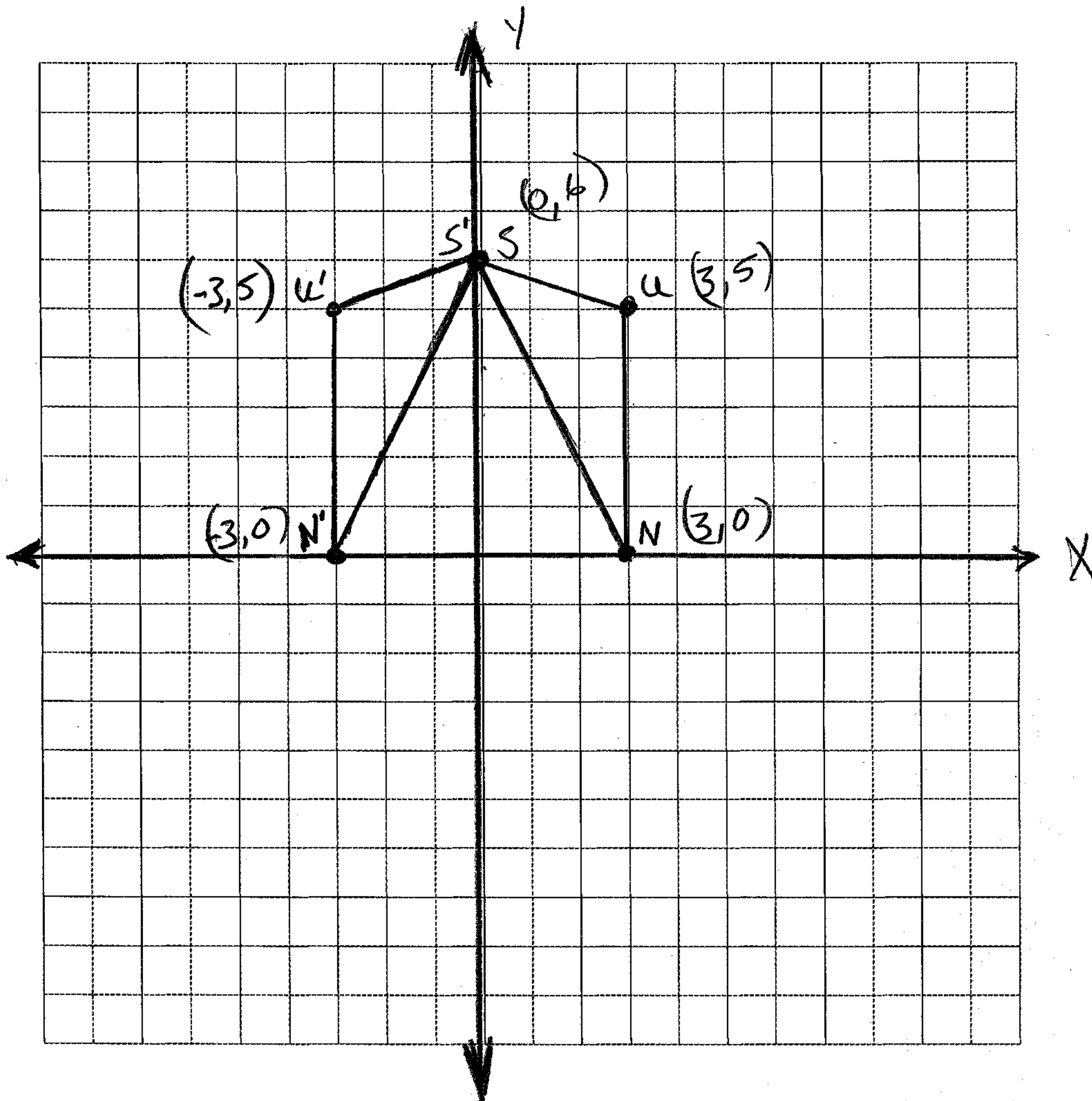

The University of the State of New York

REGENTS HIGH SCHOOL EXAMINATION

MATHEMATICS A

Friday, June 15, 2001 — 1:15 to 4:15 p.m., only

ANSWER SHEET

Pupil Sex: Male Female Grade
Teacher Steve Watson School IHS @ PH

Your answers to Part I should be recorded on this answer sheet.

Part I

Answer all 20 questions in this part.

1 <u>1</u>	6 <u>1</u>	11 <u>3</u>	16 <u>4</u>
2 <u>1</u>	7 <u>4</u>	12 <u>4</u>	17 <u>1</u>
3 <u>3</u>	8 <u>4</u>	13 <u>2</u>	18 <u>2</u>
4 <u>3</u>	9 <u>3</u>	14 <u>1</u>	19 <u>1</u>
5 <u>2</u>	10 <u>2</u>	15 <u>4</u>	20 <u>3</u>

Your answers for Parts II, III, and IV should be written in the test booklet.

The declaration below should be signed when you have completed the examination.

I do hereby affirm, at the close of this examination, that I had no unlawful knowledge of the questions or answers prior to the examination and that I have neither given nor received assistance in answering any of the questions during the examination.

Signature

Tear Here

Tear Here