

GEOMETRY

Wednesday, January 24, 2024 — 9:15 a.m. to 12:15 p.m., only

Student Name: Mr. SibelSchool Name: JMAP, Inc.

The possession or use of any communications device is strictly prohibited when taking this examination. If you have or use any communications device, no matter how briefly, your examination will be invalidated and no score will be calculated for you.

Print your name and the name of your school on the lines above.

A separate answer sheet for **Part I** has been provided to you. Follow the instructions from the proctor for completing the student information on your answer sheet.

This examination has four parts, with a total of 35 questions. You must answer all questions in this examination. Record your answers to the Part I multiple-choice questions on the separate answer sheet. Write your answers to the questions in **Parts II, III, and IV** directly in this booklet. All work should be written in pen, except graphs and drawings, which should be done in pencil. Clearly indicate the necessary steps, including appropriate formula substitutions, diagrams, graphs, charts, etc. Utilize the information provided for each question to determine your answer. Note that diagrams are not necessarily drawn to scale.

The formulas that you may need to answer some questions in this examination are found at the end of the examination. This sheet is perforated so you may remove it from this booklet.

Scrap paper is not permitted for any part of this examination, but you may use the blank spaces in this booklet as scrap paper. A perforated sheet of scrap graph paper is provided at the end of this booklet for any question for which graphing may be helpful but is not required. You may remove this sheet from this booklet. Any work done on this sheet of scrap graph paper will *not* be scored.

When you have completed the examination, you must sign the statement printed at the end of the answer sheet, indicating that you had no unlawful knowledge of the questions or answers prior to the examination and that you have neither given nor received assistance in answering any of the questions during the examination. Your answer sheet cannot be accepted if you fail to sign this declaration.

Notice ...

A graphing calculator, a straightedge (ruler), and a compass must be available for you to use while taking this examination.

DO NOT OPEN THIS EXAMINATION BOOKLET UNTIL THE SIGNAL IS GIVEN.

Part I

Answer all 24 questions in this part. Each correct answer will receive 2 credits. No partial credit will be allowed. Utilize the information provided for each question to determine your answer. Note that diagrams are not necessarily drawn to scale. For each statement or question, choose the word or expression that, of those given, best completes the statement or answers the question. Record your answers on your separate answer sheet. [48]

Use this space for computations.

1 Which expression is equal to $\sin 30^\circ$?

- (1) $\tan 30^\circ$ (3) $\cos 60^\circ$
 (2) $\sin 60^\circ$ (4) $\cos 30^\circ$

2 In the diagram of $\triangle SRA$ below, \overline{KP} is drawn such that $\angle SKP \cong \angle SRA$.

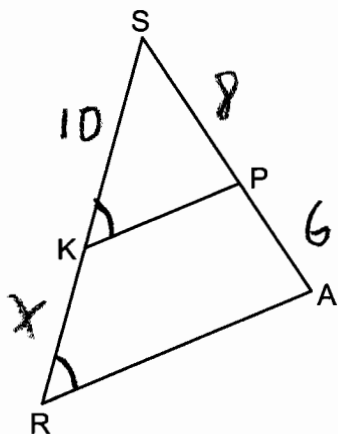

$$\frac{10}{x} = \frac{8}{6}$$

$$8x = 60$$

$$x = 7.5$$

If $SK = 10$, $SP = 8$, and $PA = 6$, what is the length of \overline{KR} , to the nearest tenth?

- (1) 4.8 (3) 8.0
 (2) 7.5 (4) 13.3

Use this space for computations.

3 A rectangle is graphed on the set of axes below.

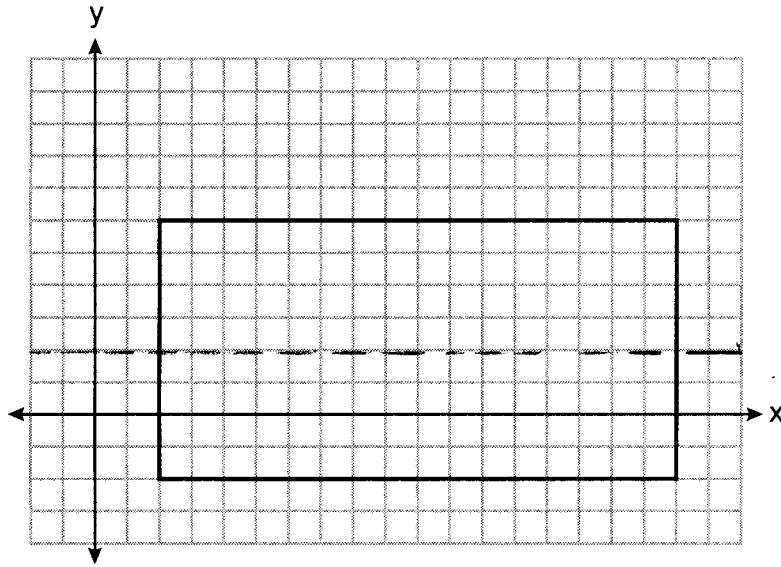

A reflection over which line would carry the rectangle onto itself?

- (1) $y = 2$
- (2) $y = 10$
- (3) $y = \frac{1}{2}x - 3$
- (4) $y = -\frac{1}{2}x + 7$

4 The surface of the roof of a house is modeled by two congruent rectangles with dimensions 40 feet by 16 feet, as shown below.

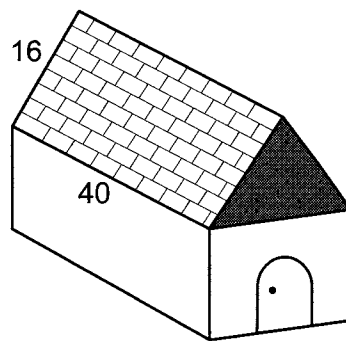
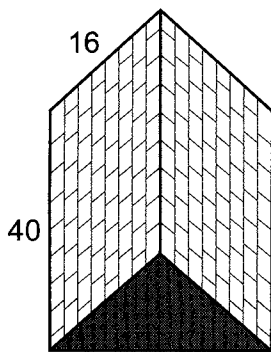

$$\frac{2(40 \cdot 16)}{33\frac{1}{3}} = 38.4$$

Roofing shingles are sold in bundles. Each bundle covers $33\frac{1}{3}$ square feet. What is the minimum number of bundles that must be purchased to completely cover both rectangular sides of the roof?

- (1) 20
- (2) 2
- (3) 39
- (4) 4

Use this space for computations.

5 Which equation represents a line that is perpendicular to the line whose equation is $y - 3x = 4$?

(1) $y = -\frac{1}{3}x - 4$

(3) $y = -3x + 4$

(2) $y = \frac{1}{3}x + 4$

(4) $y = 3x - 4$

$y = 3x + 4$

$m = 3$

$m_{\perp} = -\frac{1}{3}$

6 A vertical mine shaft is modeled in the diagram below. At a point on the ground 50 feet from the top of the mine, a ventilation tunnel is dug at an angle of 47° .

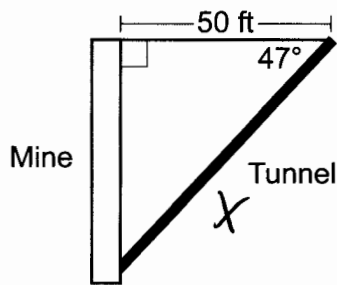

$\cos 47 = \frac{50}{x}$
 $x \approx 73$

What is the length of the tunnel, to the nearest foot?

(1) 47

(3) 68

(2) 54

(4) 73

Use this space for
computations.

- 7 On the set of axes below, $\triangle BLU$ has vertices with coordinates $B(-3, -2)$, $L(-2, 5)$, and $U(1, 1)$.

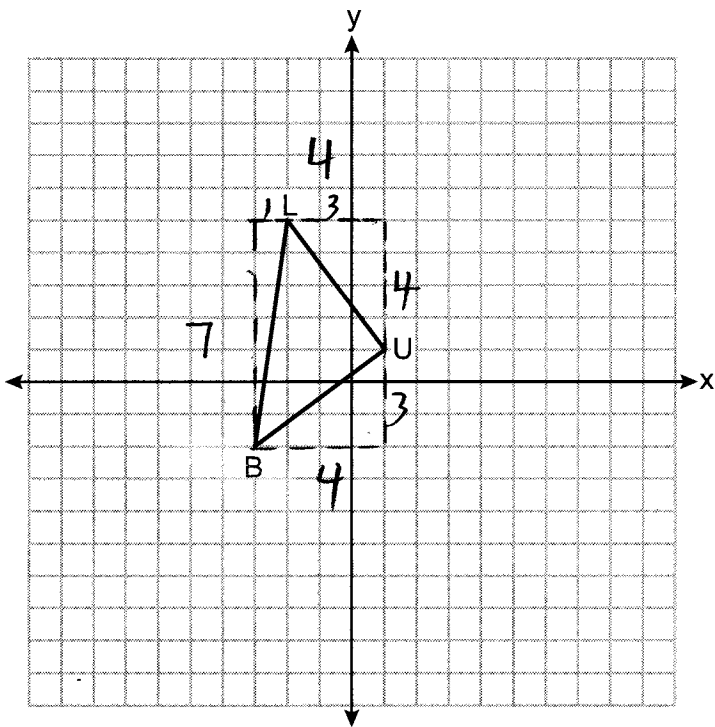

What is the area of $\triangle BLU$?

- (1) 11
(2) 12.5
(3) 14
(4) 17.1

$$7 \cdot 4 - \frac{1}{2}(7)(1) - \frac{1}{2}(3)(4) - \frac{1}{2}(4)(3)$$

$$28 - \frac{7}{2} - 6 - 6$$

$$12.5$$

Use this space for computations.

8 In the diagram below, $\triangle CAR$ is mapped onto $\triangle BUS$ after a sequence of rigid motions.

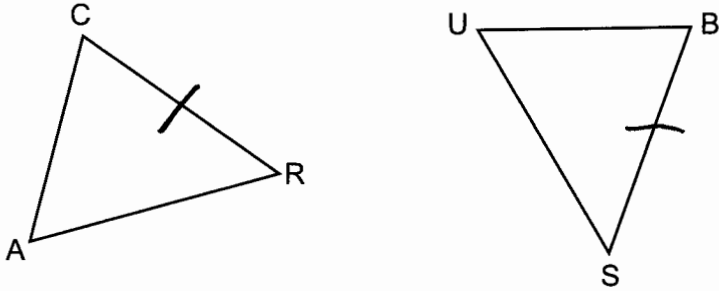

If $AR = 3x + 4$, $RC = 5x - 10$, $CA = 2x + 6$, and $SB = 4x - 4$, what is the length of \overline{SB} ?

- (1) 6
- (2) 16

- (3) 20
- (4) 28

$5x - 10 = 4x - 4$
 $x = 6$
 $4(6) - 4 = 20$

9 In the diagram below, $\triangle GHJ$ is dilated by a scale factor of $\frac{1}{2}$ centered at point B to map onto $\triangle CDF$.

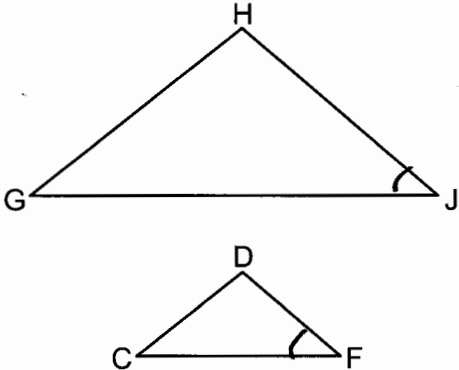

B•

If $m\angle DFC = 40^\circ$, what is $m\angle HJG$?

- (1) 20°
- (2) 40°
- (3) 60°
- (4) 80°

Use this space for computations.

10 Directed line segment \overline{AJ} has endpoints whose coordinates are $A(5,7)$ and $J(-10,-8)$. Point E is on \overline{AJ} such that $AE:EJ$ is 2:3. What are the coordinates of point E ?

(1) $(1,-1)$

(2) $(-5,-3)$

(3) $(-4,-2)$

(4) $(-1,1)$

$$5 + \frac{2}{5}(-10-5) = -1$$

$$7 + \frac{2}{5}(-8-7) = 1$$

11 A tipping platform is a ramp used to unload trucks, as shown in the diagram below.

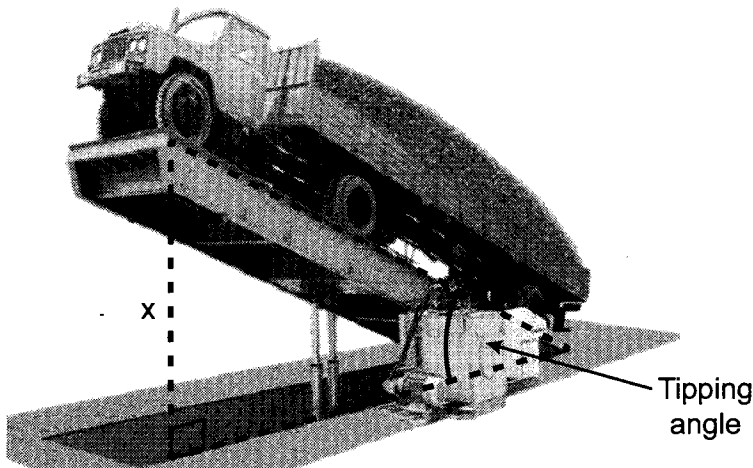

The truck is on a 75-foot-long ramp. The ramp is tipped at an angle of 30° . What is the height of the upper end of the ramp, x , to the nearest tenth of a foot?

(1) 68.7

(2) 65.0

(3) 43.3

(4) 37.5

$$\sin 30 = \frac{x}{75}$$

$$x = 37.5$$

Use this space for computations.

- 12 In the diagram below of right triangle MET , altitude \overline{ES} is drawn to hypotenuse \overline{MT} .

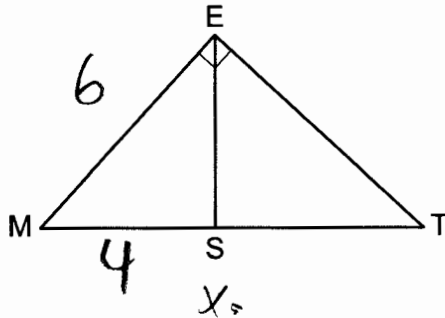

$$\begin{aligned}6^2 &= 4x \\ 36 &= 4x \\ 9 &= x\end{aligned}$$

If $ME = 6$ and $SM = 4$, what is MT ?

- (1) 9 (3) 5
(2) 8 (4) 4

- 13 In the diagram below of square $CASH$, diagonals \overline{AH} and \overline{CS} intersect at Z .

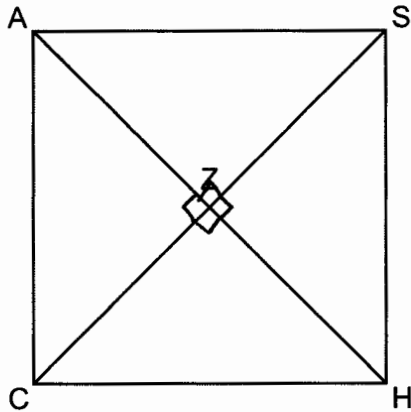

Which statement is true?

- (1) $m\angle ACZ > m\angle ZCH$ (3) $m\angle AZC = m\angle SHC$
(2) $m\angle ACZ < m\angle ASZ$ (4) $m\angle AZC = m\angle ZCH$

Use this space for computations.

14 In the diagram below of circle O , secants \overline{CFD} and \overline{CHE} are drawn from external point C .

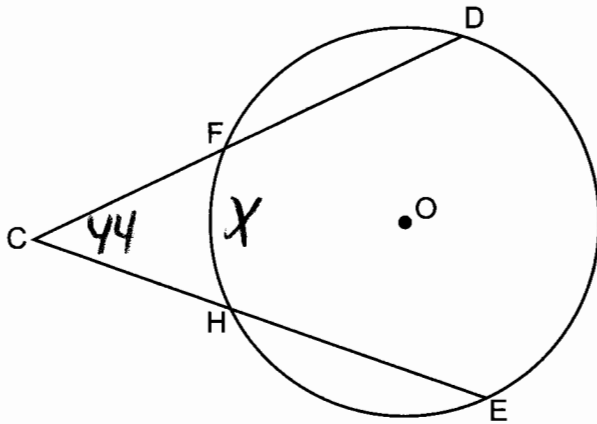

136°

$$\frac{136 - x}{2} = 44$$

$$136 - x = 88$$

$$48 = x$$

If $m\widehat{DE} = 136^\circ$ and $m\angle C = 44^\circ$, then $m\widehat{FH}$ is

- (1) 46°
- (2) 48°
- (3) 68°
- (4) 88°

15 A right circular cylinder has a diameter of 8 inches and a height of 12 inches. Which two-dimensional figure shows a cross section that is perpendicular to the base and passes through the center of the base?

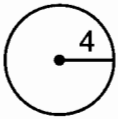

(1)

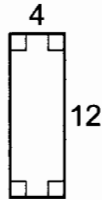

(3)

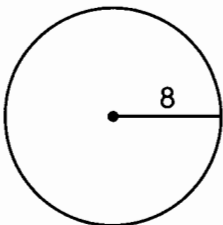

(2)

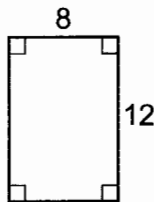

(4)

Use this space for computations.

- 16 On the set of axes below, \overline{AB} is drawn and passes through $A(-2,6)$ and $B(4,0)$.

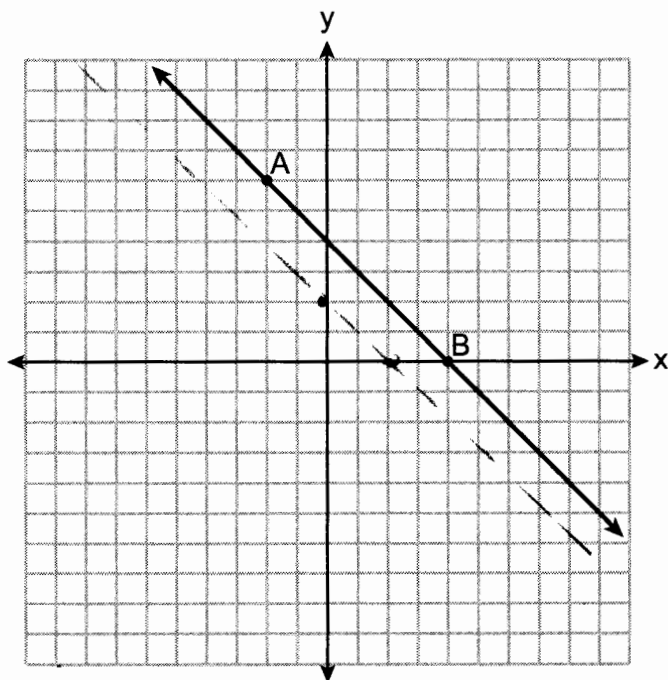

If \overline{CD} is the image of \overline{AB} after a dilation with a scale factor of $\frac{1}{2}$ centered at the origin, which equation represents \overline{CD} ?

- (1) $y = -x + 4$ (3) $y = -\frac{1}{2}x + 4$
 (2) $y = -x + 2$ (4) $y = -\frac{1}{2}x + 2$

- 17 In parallelogram $ABCD$ with $\overline{AC} \perp \overline{BD}$, $AC = 12$ and $BD = 16$. What is the perimeter of $ABCD$?

- (1) 10 (3) 40
 (2) 24 (4) 56

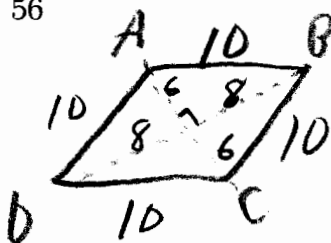

18 In the diagram of $\triangle CAT$ below, $m\angle A = 90^\circ$ and altitude \overline{AE} is drawn from vertex A .

Use this space for computations.

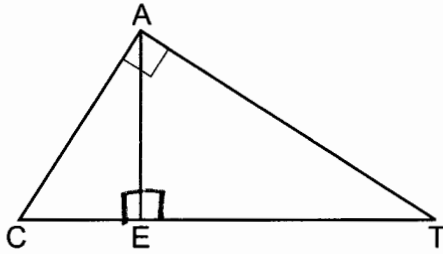

Which statement is always true?

(1) $\frac{CE}{AE} = \frac{AE}{ET}$

(3) $\frac{AC}{CE} = \frac{AT}{ET}$

(2) $\frac{AE}{CE} = \frac{AE}{ET}$

(4) $\frac{CE}{AC} = \frac{AC}{ET}$

19 A sandbox in the shape of a rectangular prism has a length of 43 inches and a width of 30 inches. Jack uses bags of sand to fill the sandbox to a depth of 9 inches. Each bag of sand has a volume of 0.5 cubic foot. What is the minimum number of bags of sand that must be purchased to fill the sandbox?

(1) 14

(3) 7

(2) 13

(4) 4

$$\frac{43 \times 30 \times 9}{864} \approx 13.4$$

$$5 \text{ ft}^3 \cdot \frac{1728 \text{ in}^3}{1 \text{ ft}^3} = 864 \text{ in}^3$$

Use this space for computations.

20 Parallelogram $EATK$ has diagonals \overline{ET} and \overline{AK} . Which information is always sufficient to prove $EATK$ is a rhombus?

- (1) $\overline{EA} \perp \overline{AT}$ (3) $\overline{ET} \cong \overline{AK}$
 (2) $\overline{EA} \cong \overline{AT}$ (4) $\overline{ET} \cong \overline{AT}$

21 In the diagram below, $\overline{ABCD} \parallel \overline{EHK}$, and \overline{MBHP} and \overline{NCHL} are drawn such that $\overline{BC} \cong \overline{BH}$.

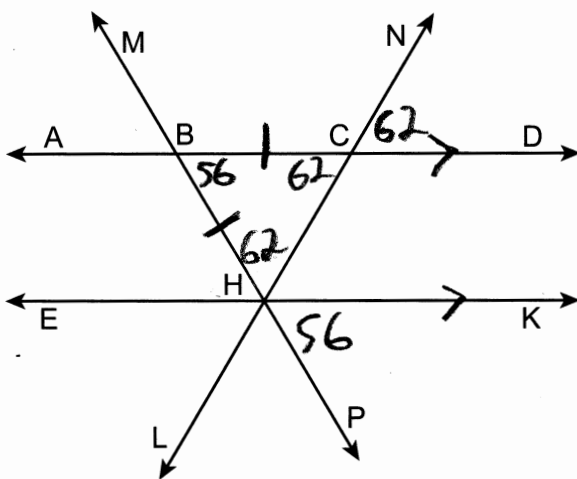

If $m\angle NCD = 62^\circ$, what is $m\angle PHK$?

- (1) 118° (3) 62°
 (2) 68° (4) 56°

22 Triangles YEG and POM are two distinct non-right triangles such that $\angle G \cong \angle M$. Which statement is sufficient to prove $\triangle YEG$ is always congruent to $\triangle POM$?

- (1) $\angle E \cong \angle O$ and $\angle Y \cong \angle P$ AAA
 (2) $\overline{YG} \cong \overline{PM}$ and $\overline{YE} \cong \overline{PO}$ SSA
 (3) There is a sequence of rigid motions that maps $\angle E$ onto $\angle O$ and \overline{YE} onto \overline{PO} . AAS
 (4) There is a sequence of rigid motions that maps point Y onto point P and \overline{YG} onto \overline{PM} . AS

Use this space for
computations.

- 23 In the diagram of triangles ABD and CBE below, sides \overline{AD} and \overline{CE} intersect at F , and $\angle ADB \cong \angle CEB$.

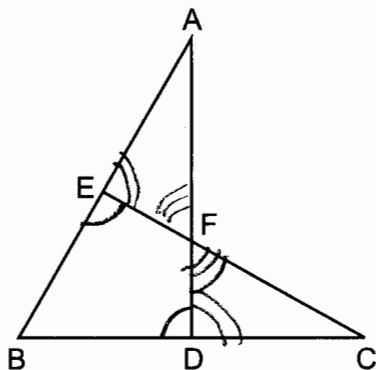

Which statement can *not* be proven?

- (1) $\triangle ADB \cong \triangle CEB$ (3) $\triangle ADB \sim \triangle CEB$
(2) $\angle EAF \cong \angle DCF$ (4) $\triangle EAF \sim \triangle DCF$
- 24 A small town is installing a water storage tank in the shape of a cylinder. The tank must be able to hold at least 100,000 gallons of water. The tank must have a height of exactly 30 feet.
[1 cubic foot holds 7.48 gallons of water]

What should the minimum diameter of the tank be, to the *nearest* foot?

- (1) 12 (3) 65
(2) 24 (4) 75

$$\frac{100000 \text{ g}}{7.48 \text{ g/ft}^3} = \pi r^2 (30 \text{ ft})$$
$$11.92 \approx r$$
$$23.8 \approx d$$

Part II

Answer all 7 questions in this part. Each correct answer will receive 2 credits. Clearly indicate the necessary steps, including appropriate formula substitutions, diagrams, graphs, charts, etc. Utilize the information provided for each question to determine your answer. Note that diagrams are not necessarily drawn to scale. For all questions in this part, a correct numerical answer with no work shown will receive only 1 credit. All answers should be written in pen, except for graphs and drawings, which should be done in pencil. [14]

25 In isosceles triangle ABC shown below, $\overline{AB} \cong \overline{AC}$, and altitude \overline{AD} is drawn.

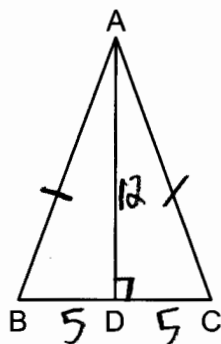

The length of \overline{AD} is 12 cm and the length of \overline{BC} is 10 cm.

Determine and state, to the nearest cubic centimeter, the volume of the solid formed by continuously rotating $\triangle ABC$ about \overline{AD} .

$$\begin{aligned} V &= \frac{1}{3} \pi (5)^2 (12) \\ &= 100\pi \\ &\approx 314 \end{aligned}$$

- 26 The diagram below models the projection of light from a lighthouse, L . The sector has a radius of 38 miles and spans 102° .

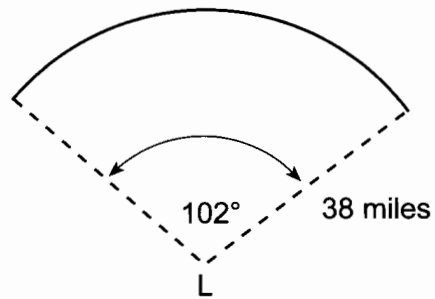

Determine and state the area of the sector, to the *nearest square mile*.

$$\frac{102}{360} \pi (38)^2 \approx 1785$$

27 Segment CA is drawn below. Using a compass and straightedge, construct isosceles right triangle CAT where $\overline{CA} \perp \overline{CT}$ and $\overline{CA} \cong \overline{CT}$.

[Leave all construction marks.]

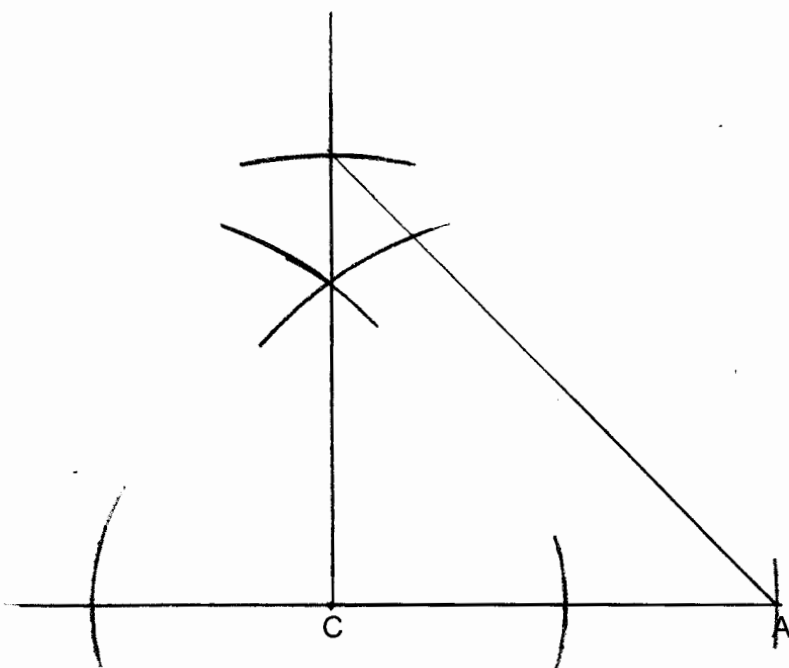

28 On the set of axes below, congruent triangles ABC and DEF are graphed.

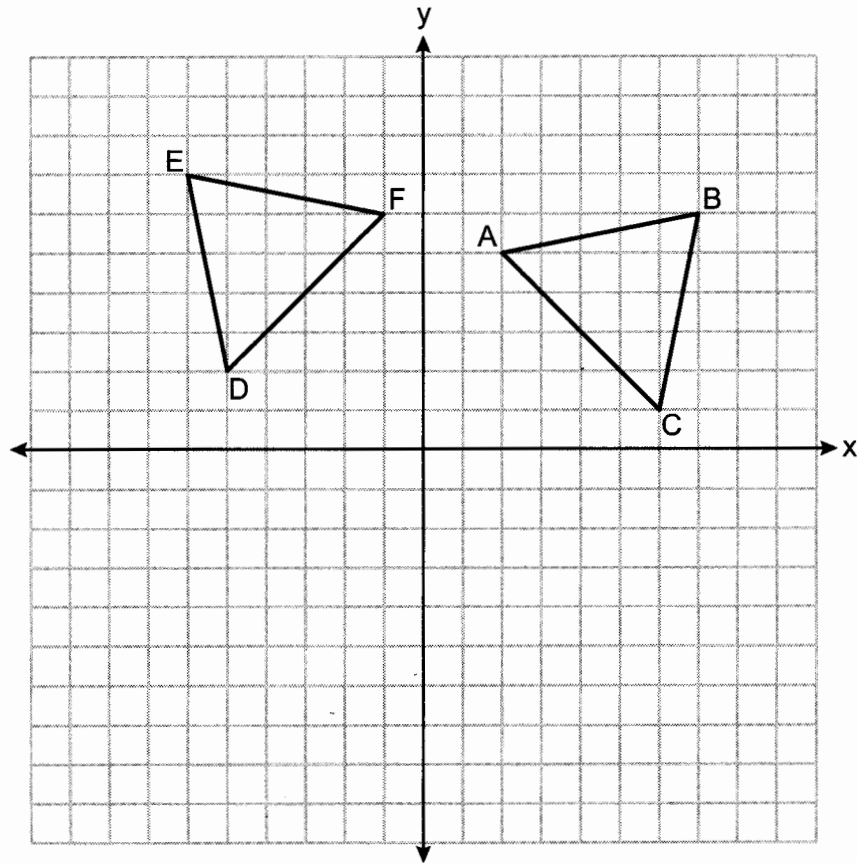

Describe a sequence of rigid motions that maps $\triangle ABC$ onto $\triangle DEF$.

Rotation of 90° counterclockwise
about the origin

29 In $\triangle ADC$ below, \overline{EB} is drawn such that $AB = 4.1$, $AE = 5.6$, $BC = 8.22$, and $ED = 3.42$.

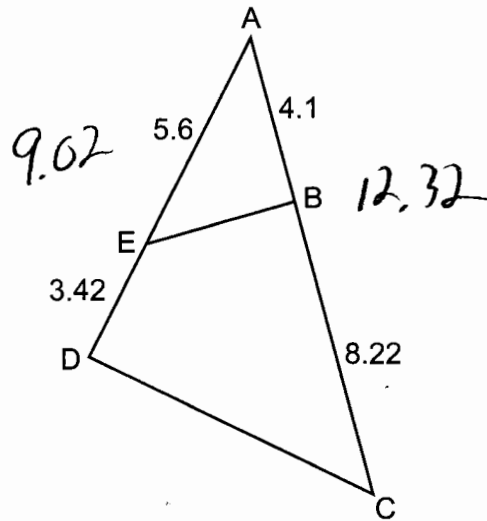

Is $\triangle ABE$ similar to $\triangle ADC$? Explain why. **Yes**

$$\frac{AB}{AD} = \frac{AE}{AC}$$

$$\frac{4.1}{9.02} = \frac{5.6}{12.32}$$

SAS

$$50.512 = 50.512$$

- 30 Determine and state the coordinates of the center and the length of the radius of the circle represented by the equation $x^2 + 16x + y^2 + 12y - 44 = 0$.

$$x^2 + 16x + 64 + y^2 + 12y + 36 = 44 + 64 + 36$$

$$(x+8)^2 + (y+6)^2 = 144$$

$$(-8, -6)$$

$$12$$

31 In the diagram below, $\triangle SBC \sim \triangle CMJ$ and $\cos J = \frac{3}{5}$.

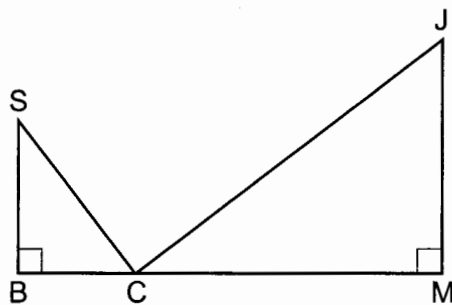

Determine and state $m\angle S$, to the *nearest degree*.

$$\cos J = \frac{3}{5}$$

$$J \approx 53$$

$$S \approx 90 - 53 \approx 37$$

Part III

Answer all 3 questions in this part. Each correct answer will receive 4 credits. Clearly indicate the necessary steps, including appropriate formula substitutions, diagrams, graphs, charts, etc. Utilize the information provided for each question to determine your answer. Note that diagrams are not necessarily drawn to scale. For all questions in this part, a correct numerical answer with no work shown will receive only 1 credit. All answers should be written in pen, except for graphs and drawings, which should be done in pencil. [12]

- 32 Trish is a surveyor who was asked to estimate the distance across a pond. She stands at point C , 85 meters from point D , and locates points A and B on either side of the pond such that A , D , and B are collinear.

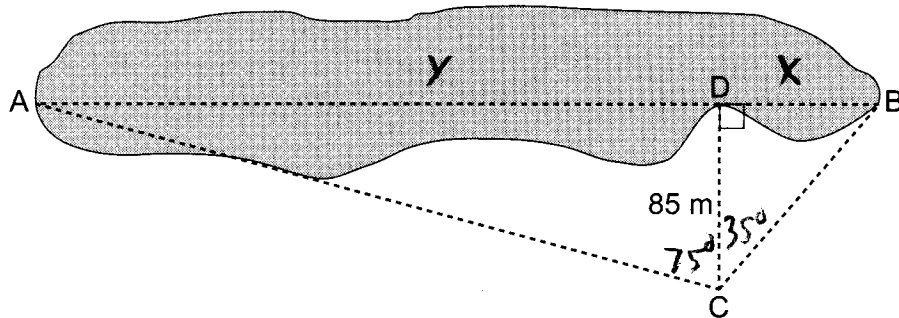

Trish approximates the measure of angle DCB to be 35° and the measure of angle ACD to be 75° .

Determine and state the distance across the pond, \overline{AB} , to the nearest meter.

$$\tan 75 = \frac{y}{85}$$

$$y \approx 317.2$$

$$\tan 35 = \frac{x}{85}$$

$$x \approx 59.5$$

$$377$$

- 33 A candle in the shape of a right pyramid is modeled below. Each side of the square base measures 12 centimeters. The slant height of the pyramid measures 16 centimeters.

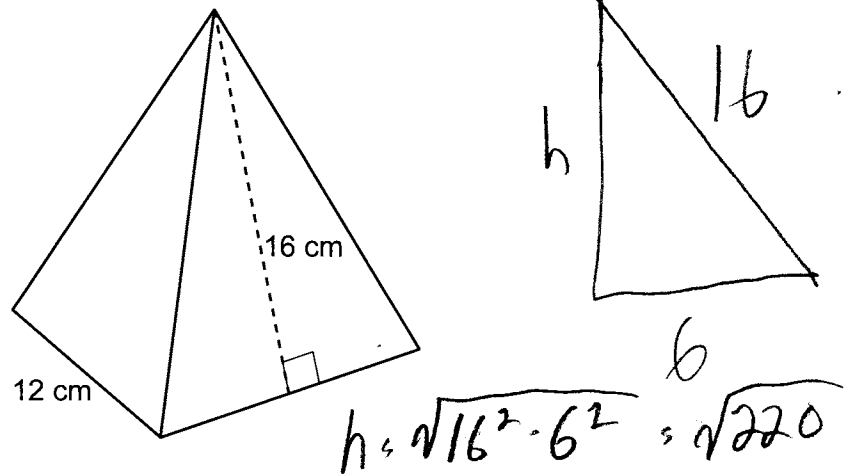

Determine and state the volume of the candle, to the *nearest cubic centimeter*.

$$V = \frac{1}{3} (12)^2 \sqrt{220} \approx 712$$

The wax used to make the candle weighs 0.032 ounce per cubic centimeter. Determine and state the weight of the candle, to the *nearest ounce*.

$$712 \times 0.032 \approx 23$$

34 In the diagram of quadrilateral $ABCD$ below, $\overline{AB} \cong \overline{CD}$, and $\overline{AB} \parallel \overline{CD}$.
 Segments CE and AF are drawn to diagonal \overline{BD} such that $\overline{BE} \cong \overline{DF}$.

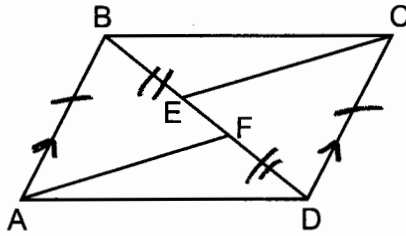

Prove: $\overline{CE} \cong \overline{AF}$

STATEMENT

REASON

① Quadrilateral $ABCD$, $\overline{AB} \cong \overline{CD}$,
 $\overline{AB} \parallel \overline{CD}$, segments CE &
 AF drawn to diagonal \overline{BD}
 so that $\overline{BE} \cong \overline{DF}$

① Given

② $\angle ABF \cong \angle CDE$

② Parallel lines cut by a transversal form congruent alternate interior angles

③ $\overline{EF} \cong \overline{FE}$

③ Reflexive

④ $\overline{BE} + \overline{EF} \cong \overline{BF} + \overline{FE}$

④ Addition

$\overline{BF} \cong \overline{DE}$

⑤ $\triangle AFB \cong \triangle CED$

⑤ SAS

⑥ $\overline{CE} \cong \overline{AF}$

⑥ CPCTC

Part IV

Answer the question in this part. A correct answer will receive 6 credits. Clearly indicate the necessary steps, including appropriate formula substitutions, diagrams, graphs, charts, etc. Utilize the information provided to determine your answer. Note that diagrams are not necessarily drawn to scale. A correct numerical answer with no work shown will receive only 1 credit. All answers should be written in pen, except for graphs and drawings, which should be done in pencil. [6]

35 Quadrilateral $MATH$ has vertices with coordinates $M(-1,7)$, $A(3,5)$, $T(2,-7)$, and $H(-6,-3)$.

Prove that quadrilateral $MATH$ is a trapezoid.

[The use of the set of axes on the next page is optional.]

The slope of both \overline{MA} & \overline{TH} equals $-\frac{1}{2}$.
Distinct lines that have the same slope
are parallel.
 $MATH$ is a trapezoid because it has a
pair of parallel lines.

State the coordinates of point Y such that point A is the midpoint of \overline{MY} .

$(7, 3)$

Question 35 is continued on the next page.

Question 35 continued

Prove that quadrilateral $MYTH$ is a rectangle. [The use of the set of axes below is optional.]

The slope of \overline{MY} & \overline{TH} equals $-\frac{1}{2}$.
The slope of \overline{YT} & \overline{HM} equals 2 .
The slopes of each side are opposite reciprocals & therefore perpendicular.
Perpendicular sides form right angles,
so $MYTH$ has four right angles
& is a rectangle

