

# JEFFERSON MATH PROJECT REGENTS BY STANDARD

850 NY Math B Questions from Fall 1999 Test Sampler  
to January 2009 Regents Exam by Standard

[www.jmap.org](http://www.jmap.org)

*Dear Sir*

*I have to acknowledge the receipt of your favor of May 14. in which you mention that you have finished the 6. first books of Euclid, plane trigonometry, surveying & algebra and ask whether I think a further pursuit of that branch of science would be useful to you. there are some propositions in the latter books of Euclid, & some of Archimedes, which are useful, & I have no doubt you have been made acquainted with them. trigonometry, so far as this, is most valuable to every man, there is scarcely a day in which he will not resort to it for some of the purposes of common life. the science of calculation also is indispensable as far as the extraction of the square & cube roots; Algebra as far as the quadratic equation & the use of logarithms are often of value in ordinary cases: but all beyond these is but a luxury; a delicious luxury indeed; but not to be indulged in by one who is to have a profession to follow for his subsistence. in this light I view the conic sections, curves of the higher orders, perhaps even spherical trigonometry, Algebraical operations beyond the 2d dimension, and fluxions.*

Letter from Thomas Jefferson to William G. Munford, Monticello, June 18, 1799.

# NEW YORK STATE MATHEMATICS PERFORMANCE STANDARD

	# of ?s
<b>MATHEMATICAL REASONING</b>	34
Students use mathematical reasoning to analyze mathematical situations, make conjectures, gather evidence, and construct an argument.	
<b>NUMBER AND NUMERATION</b>	81
Students use number sense and numeration to develop an understanding of the multiple use of numbers in the real world, the use of numbers to communicate mathematically, and the use of numbers in the development of mathematical ideas.	
<b>OPERATIONS</b>	88
Students use mathematical operations and relationships among them to understand mathematics.	
<b>MODELING/MULTIPLE REPRESENTATION</b>	186
Students use mathematical modeling/multiple representation to provide a means of presenting, interpreting, communicating, and connecting mathematical information and relationships.	
<b>MEASUREMENT</b>	167
Students use measurement in both metric and English measure to provide a major link between the abstractions of mathematics and the real world in order to describe and compare objects and data.	
<b>UNCERTAINTY</b>	99
Students use the ideas of uncertainty to illustrate that mathematics involves more than exactness when dealing with everyday situations.	
<b>PATTERNS/FUNCTIONS</b>	195
Students use patterns and functions to develop mathematical power, appreciate the true beauty of mathematics, and construct generalizations that describe patterns simply and efficiently.	
<b>Total</b>	<b>850</b>

1. 010814b, P.I. G.G.27

In the accompanying diagram, line  $\ell$  is perpendicular to line  $m$  at  $A$ , line  $k$  is perpendicular to line  $m$  at  $B$ , and lines  $\ell$ ,  $m$ , and  $k$  are in the same plane.

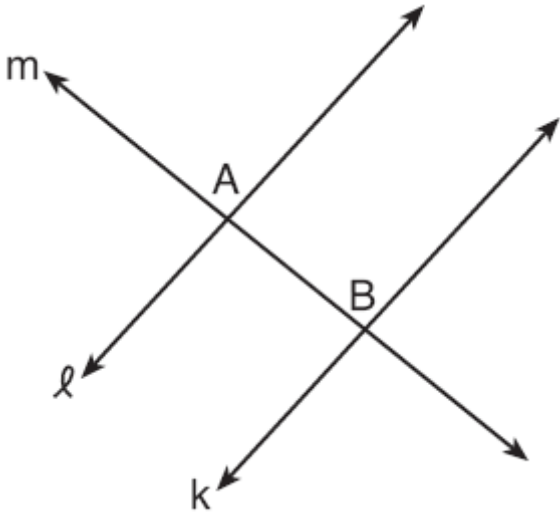

Which statement is the first step in an indirect proof to prove that  $\ell$  is parallel to  $k$ ?

- [A] Assume that  $\ell$  is perpendicular to  $k$ .
- [B] Assume that  $\ell$  is not parallel to  $k$ .
- [C] Assume that  $\ell$  is not perpendicular to  $m$ .
- [D] Assume that  $\ell$ ,  $m$ , and  $k$  are not in the same plane.

2. 010306b, P.I. G.G.28

Which statements could be used to prove that  $\triangle ABC$  and  $\triangle A'B'C'$  are congruent?

- [A]  $\overline{AB} \cong \overline{A'B'}$ ,  $\overline{BC} \cong \overline{B'C'}$ , and  $\angle A \cong \angle A'$
- [B]  $\overline{AB} \cong \overline{A'B'}$ ,  $\angle A \cong \angle A'$ , and  $\angle C \cong \angle C'$
- [C]  $\angle A \cong \angle A'$ ,  $\overline{AC} \cong \overline{A'C'}$ , and  $\overline{BC} \cong \overline{B'C'}$
- [D]  $\angle A \cong \angle A'$ ,  $\angle B \cong \angle B'$ , and  $\angle C \cong \angle C'$

3. 080112b, P.I. A2.A.20

A ball is thrown straight up at an initial velocity of 54 feet per second. The height of the ball  $t$  seconds after it is thrown is given by the formula  $h(t) = 54t - 12t^2$ . How many seconds after the ball is thrown will it return to the ground?

- [A] 9.2    [B] 4    [C] 4.5    [D] 6

4. 060533b, P.I. G.G.27

Given: parallelogram  $ABCD$ , diagonal  $\overline{AC}$ , and  $\overline{ABE}$

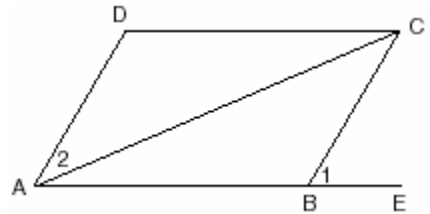

Prove:  $m\angle 1 > m\angle 2$

5. 060824b, P.I. G.G.27

The coordinates of quadrilateral  $PRAT$  are  $P(a, b)$ ,  $R(a, b + 3)$ ,  $A(a + 3, b + 4)$ , and  $T(a + 6, b + 2)$ . Prove that  $\overline{RA}$  is parallel to  $\overline{PT}$ .

6. 010732b, P.I. G.G.27

In the accompanying diagram,  $m\widehat{BR} = 70$ ,  $m\widehat{YD} = 70$ , and  $\overline{BOD}$  is the diameter of circle  $O$ . Write an explanation or a proof that shows  $\triangle RBD$  and  $\triangle YDB$  are congruent.

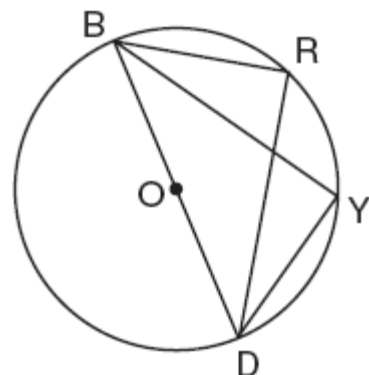

7. 080608b, P.I. G.G.24

In  $\triangle ABC$ ,  $D$  is a point on  $\overline{AC}$  such that  $\overline{BD}$  is a median. Which statement must be true?

- [A]  $\angle ABD \cong \angle CBD$     [B]  $\overline{AD} \cong \overline{CD}$   
[C]  $\triangle ABD \cong \triangle CBD$     [D]  $\overline{BD} \perp \overline{AC}$

8. 080434b, P.I. G.G.69

The coordinates of quadrilateral  $JKLM$  are  $J(1,-2)$ ,  $K(13,4)$ ,  $L(6,8)$ , and  $M(-2,4)$ . Prove that quadrilateral  $JKLM$  is a trapezoid but not an isosceles trapezoid. [The use of the grid is optional.]

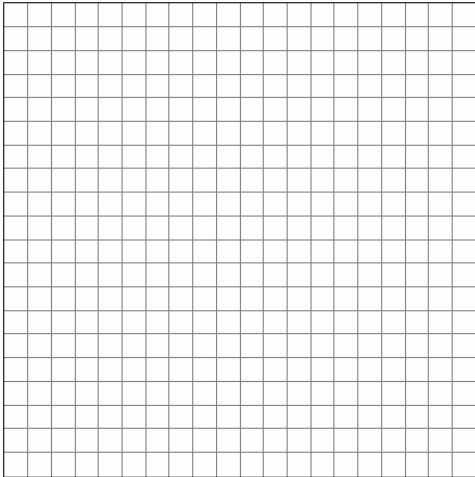

9. 080326b

Tom scored 23 points in a basketball game. He attempted 15 field goals and 6 free throws. If each successful field goal is 2 points and each successful free throw is 1 point, is it possible he successfully made all 6 of his free throws? Justify your answer.

10. 080731b, P.I. G.G.27

The accompanying diagram shows quadrilateral  $BRON$ , with diagonals  $\overline{NR}$  and  $\overline{BO}$ , which bisect each other at  $X$ .

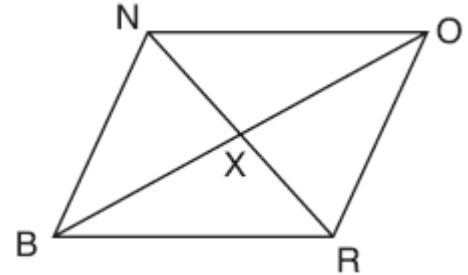

Prove:  $\triangle BNX \cong \triangle ORX$

11. 060204b, P.I. G.G.28

In the accompanying diagram of  $\triangle ABC$ ,  $\overline{AB} \cong \overline{AC}$ ,  $\overline{BD} = \frac{1}{3}\overline{BA}$ , and  $\overline{CE} = \frac{1}{3}\overline{CA}$ .

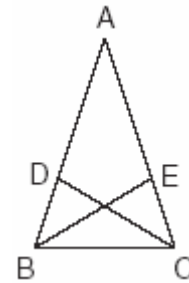

Triangle  $EBC$  can be proved congruent to triangle  $DCB$  by

- [A] ASA  $\cong$  ASA    [B] SSS  $\cong$  SSS  
[C] HL  $\cong$  HL    [D] SAS  $\cong$  SAS

12. 010533b, P.I. G.G.69

Jim is experimenting with a new drawing program on his computer. He created quadrilateral  $TEAM$  with coordinates  $T(-2,3)$ ,  $E(-5,-4)$ ,  $A(2,-1)$ , and  $M(5,6)$ . Jim believes that he has created a rhombus but not a square. Prove that Jim is correct. [The use of the grid is optional.]

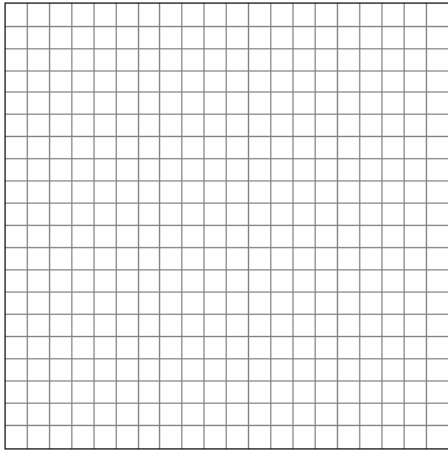

15. 010333b, P.I. G.G.69

Quadrilateral  $KATE$  has vertices  $K(1,5)$ ,  $A(4,7)$ ,  $T(7,3)$ , and  $E(1,-1)$ .  
a Prove that  $KATE$  is a trapezoid. [The use of the grid is optional.]  
b Prove that  $KATE$  is *not* an isosceles trapezoid.

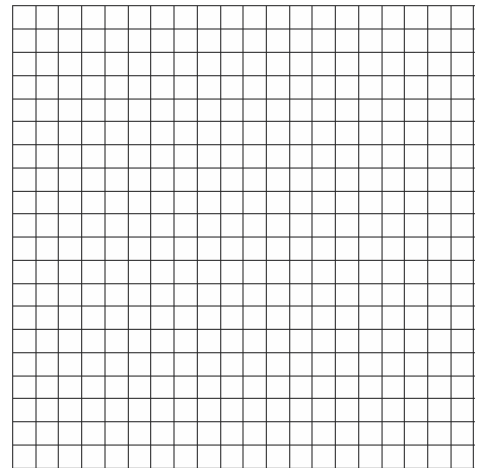

13. 080401b, P.I. G.G.28

Which condition does *not* prove that two triangles are congruent?

- [A]  $SSS \cong SSS$       [B]  $SSA \cong SSA$   
[C]  $SAS \cong SAS$       [D]  $ASA \cong ASA$

14. 060133b, P.I. G.G.44

Given: chords  $\overline{AB}$  and  $\overline{CD}$  of circle  $O$  intersect at  $E$ , an interior point of circle  $O$ ;  
chords  $\overline{AD}$  and  $\overline{CB}$  are drawn.

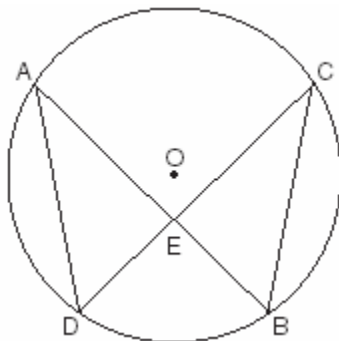

Prove:  $(AE)(EB) = (CE)(ED)$

16. 080310b, P.I. G.G.28

In the accompanying diagram of parallelogram  $ABCD$ ,  $\overline{DE} \cong \overline{BF}$ .

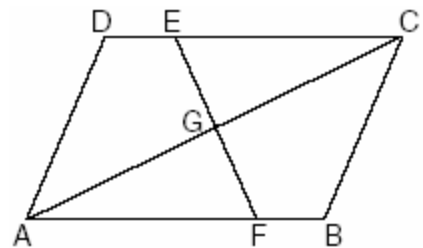

Triangle  $EGC$  can be proved congruent to triangle  $FGA$  by

- [A]  $HL \cong HL$       [B]  $SSA \cong SSA$   
[C]  $AAA \cong AAA$       [D]  $AAS \cong AAS$

17. 060327b, P.I. G.G.69

The coordinates of quadrilateral  $ABCD$  are  $A(-1,-5)$ ,  $B(8,2)$ ,  $C(11,13)$ , and  $D(2,6)$ . Using coordinate geometry, prove that quadrilateral  $ABCD$  is a rhombus. [The use of the grid is optional.]

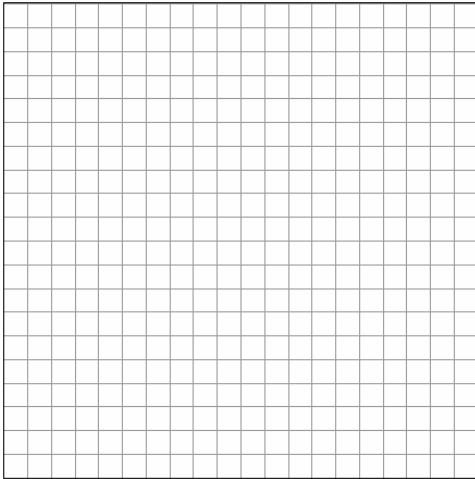

18. 060733b, P.I. G.G.69

Given: quadrilateral  $ABCD$  with vertices  $A(-2,2)$ ,  $B(8,-4)$ ,  $C(6,-10)$ , and  $D(-4,-4)$ . State the coordinates of  $A'B'C'D'$ , the image of quadrilateral  $ABCD$  under a dilation of factor  $\frac{1}{2}$ . Prove that  $A'B'C'D'$  is a parallelogram. [The use of the grid is optional.]

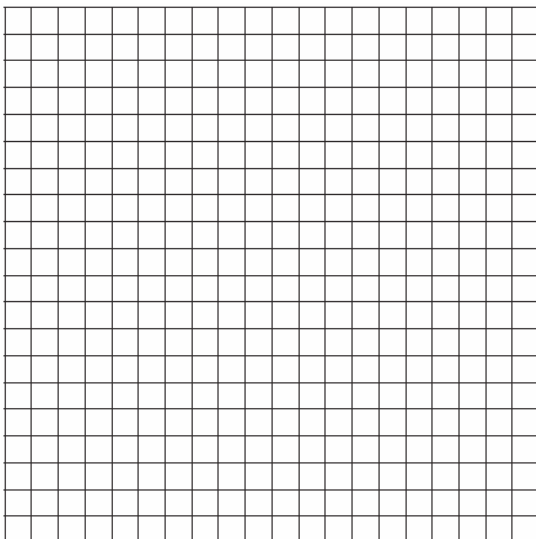

19. 080627b, P.I. G.G.44

In the accompanying diagram of circle  $O$ , diameter  $\overline{AOB}$  is drawn, tangent  $\overline{CB}$  is drawn to the circle at  $B$ ,  $E$  is a point on the circle, and  $\overline{BE} \parallel \overline{ADC}$ . Prove:  $\triangle ABE \sim \triangle CAB$

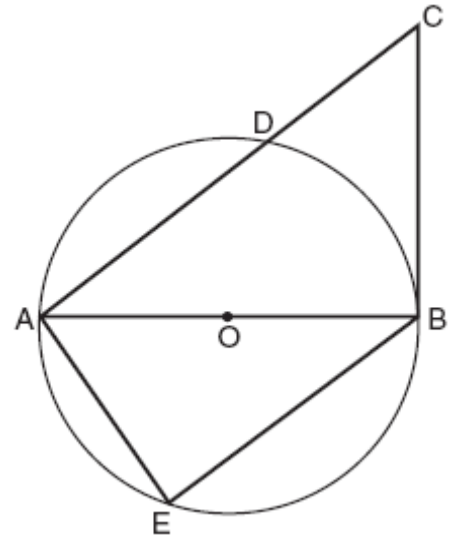

20. 010934b, P.I. G.G.27

Given:  $PROE$  is a rhombus,  $\overline{SEO}$ ,  $\overline{PEV}$ ,  $\angle SPR \cong \angle VOR$

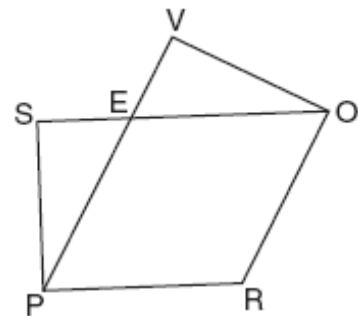

Prove:  $\overline{SE} \cong \overline{EV}$

21. 080834b, P.I. G.G.27

A tricolored flag is made out of a rectangular piece of cloth whose corners are labeled  $A$ ,  $B$ ,  $C$ , and  $D$ . The colored regions are separated by two line segments,  $\overline{BM}$  and  $\overline{CM}$ , that meet at point  $M$ , the midpoint of side  $\overline{AD}$ . Prove that the two line segments that separate the regions will always be equal in length, regardless of the size of the flag.

22. 010432b, P.I. G.G.27

In the accompanying diagram of circle  $O$ ,  $\overline{PA}$  is drawn tangent to the circle at  $A$ . Place  $B$  on  $\overline{PA}$  anywhere between  $P$  and  $A$  and draw  $\overline{OA}$ ,  $\overline{OP}$ , and  $\overline{OB}$ . Prove that  $\overline{OB}$  is not perpendicular to  $\overline{PA}$ .

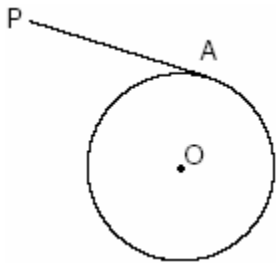

23. 060425b, P.I. G.G.27

Given:  $\triangle ABT$ ,  $\overline{CBTD}$ , and  $\overline{AB} \perp \overline{CD}$

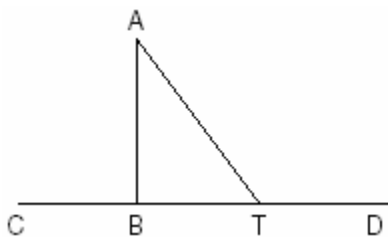

Write an indirect proof to show that  $\overline{AT}$  is not perpendicular to  $\overline{CD}$ .

24. fall9933b, P.I. G.G.27

Given trapezoid  $ROSE$  with diagonals  $\overline{RS}$  and  $\overline{EO}$  intersecting at point  $I$ , prove that the diagonals of the trapezoid do *not* bisect each other.

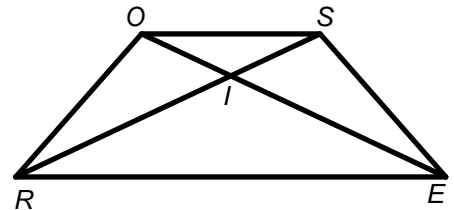

25. 060633b, P.I. G.G.69

Given:  $A(-2,2)$ ,  $B(6,5)$ ,  $C(4,0)$ ,  $D(-4,-3)$   
Prove:  $ABCD$  is a parallelogram but not a rectangle. [The use of the grid is optional.]

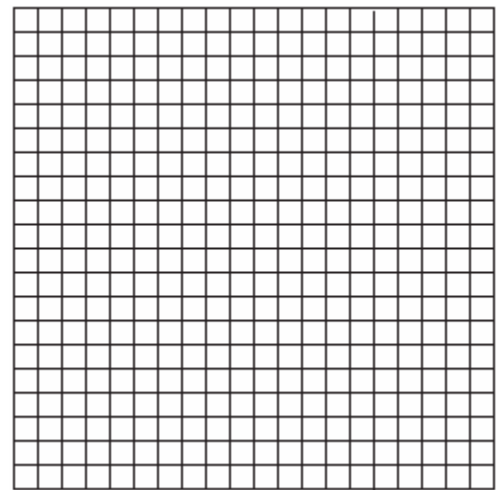

26. 060420b, P.I. G.G.28

In the accompanying diagram,  $\overline{HK}$  bisects  $\overline{IL}$  and  $\angle H \cong \angle K$ .

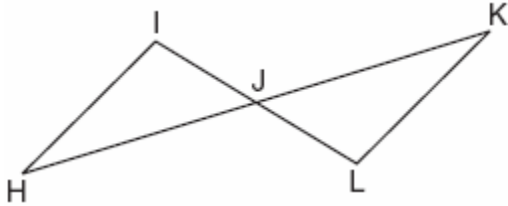

What is the most direct method of proof that could be used to prove  $\triangle HIJ \cong \triangle KLJ$ ?

- [A]  $AAS \cong AAS$       [B]  $SAS \cong SAS$   
[C]  $HL \cong HL$       [D]  $ASA \cong ASA$

27. 080534b, P.I. G.G.27

In the accompanying diagram of  $ABCD$ , where  $a \neq b$ , prove  $ABCD$  is an isosceles trapezoid.

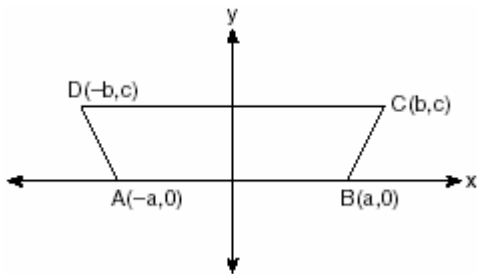

28. 010833b, P.I. G.G.44

In the accompanying diagram,  $\overline{WA} \parallel \overline{CH}$  and  $\overline{WH}$  and  $\overline{AC}$  intersect at point  $T$ . Prove that  $(WT)(CT) = (HT)(AT)$ .

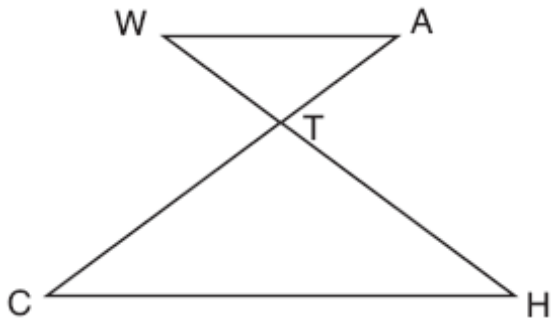

29. 060320b, P.I. G.G.28

In the accompanying diagram,  $\overline{CA} \perp \overline{AB}$ ,  $\overline{ED} \perp \overline{DF}$ ,  $\overline{ED} \parallel \overline{AB}$ ,  $\overline{CE} \cong \overline{BF}$ ,  $\overline{AB} \cong \overline{ED}$  and  $m\angle CAB = m\angle FDE = 90$ .

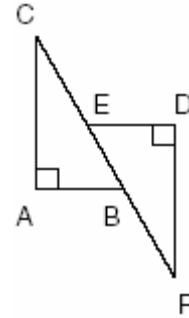

Which statement would *not* be used to prove  $\triangle ABC \cong \triangle DEF$ ?

- [A]  $AAS \cong AAS$       [B]  $SAS \cong SAS$   
[C]  $SSS \cong SSS$       [D]  $HL \cong HL$

30. 080230b, P.I. G.G.27

In the accompanying diagram,  $\triangle ABC$  is *not* isosceles. Prove that if altitude  $\overline{BD}$  were drawn, it would *not* bisect  $\overline{AC}$ .

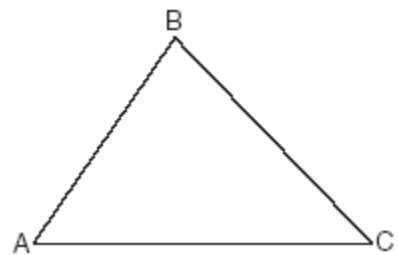



31. 060229b, P.I. G.G.27

Complete the partial proof below for the accompanying diagram by providing reasons for steps 3, 6, 8, and 9.

Given:  $\overline{AFCD}$   
 $\overline{AB} \perp \overline{BC}$   
 $\overline{DE} \perp \overline{EF}$   
 $\overline{BC} \parallel \overline{FE}$   
 $\overline{AB} \cong \overline{DE}$

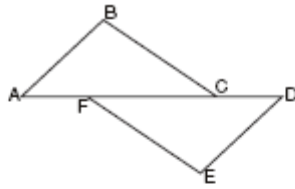

Prove:  $\overline{AC} \cong \overline{FD}$

Statements	Reasons
1 $\overline{AFCD}$	1 Given
2 $\overline{AB} \perp \overline{BC}$ , $\overline{DE} \perp \overline{EF}$	2 Given
3 $\angle B$ and $\angle E$ are right angles.	3 _____
4 $\angle B \cong \angle E$	4 All right angles are congruent.
5 $\overline{BC} \parallel \overline{FE}$	5 Given
6 $\angle BCA \cong \angle EFD$	6 _____
7 $\overline{AB} \cong \overline{DE}$	7 Given
8 $\triangle ABC \cong \triangle DEF$	8 _____
9 $\overline{AC} \cong \overline{FD}$	9 _____

32. 080129b, P.I. A2.S.5

Twenty high school students took an examination and received the following scores: 70, 60, 75, 68, 85, 86, 78, 72, 82, 88, 88, 73, 74, 79, 86, 82, 90, 92, 93, 73.

Determine what percent of the students scored within one standard deviation of the mean.

Do the results of the examination approximate a normal distribution? Justify your answer.

33. 010233b, P.I. G.G.27

Prove that the diagonals of a parallelogram bisect each other.

34. 010634b, P.I. G.G.27

Given: parallelogram  $FLSH$ , diagonal  $\overline{FGAS}$ ,  $\overline{LG} \perp \overline{FS}$ ,  $\overline{HA} \perp \overline{FS}$

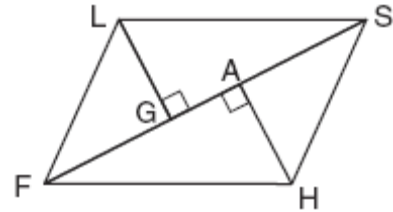

Prove:  $\triangle LGS \cong \triangle HAF$

1. 080217b, A2.A.25

If the sum of the roots of  $x^2 + 3x - 5$  is added to the product of its roots, the result is

- [A] -8 [B] 15 [C] -15 [D] -2

2. 060103b, P.I. A2.A.2

Jacob is solving a quadratic equation. He executes a program on his graphing calculator and sees that the roots are real, rational, and unequal. This information indicates to Jacob that the discriminant is

- [A] not a perfect square [B] negative  
[C] a perfect square [D] zero

3. 010312b, P.I. A2.A.17

The fraction  $\frac{\frac{x}{y} + x}{\frac{1}{y} + 1}$  is equivalent to

- [A]  $\frac{2xy}{1+y}$  [B]  $2x$  [C]  $\frac{x^2y}{1+y}$  [D]  $x$

4. 060504b, P.I. A.A.16

Written in simplest form, the expression

$\frac{x^2 - 9x}{45x - 5x^2}$  is equivalent to

- [A] 5 [B]  $-\frac{1}{5}$  [C]  $\frac{1}{5}$  [D] -5

5. 060606b, P.I. A2.A.21

If the equation  $x^2 - kx - 36 = 0$  has  $x = 12$  as one root, what is the value of  $k$ ?

- [A] -3 [B] 9 [C] -9 [D] 3

6. 060305b, P.I. A2.N.5

Which expression is equivalent to  $\frac{4}{3 + \sqrt{2}}$ ?

- [A]  $\frac{12 - 4\sqrt{2}}{11}$  [B]  $\frac{12 + 4\sqrt{2}}{11}$   
[C]  $\frac{12 - 4\sqrt{2}}{7}$  [D]  $\frac{12 + 4\sqrt{2}}{7}$

7. 080411b, P.I. A2.A.2

The equation  $2x^2 + 8x + n = 0$  has imaginary roots when  $n$  is equal to

- [A] 8 [B] 10 [C] 4 [D] 6

8. 010629b, P.I. A2.A.17

Simplify completely:  $\frac{1-m}{m - \frac{1}{m}}$

9. 010224b, P.I. A2.A.23

A rectangle is said to have a golden ratio

when  $\frac{w}{h} = \frac{h}{w-h}$ , where  $w$  represents width and  $h$  represents height. When  $w = 3$ , between which two consecutive integers will  $h$  lie?

10. 060712b, P.I. A.A.16

Which expression is in simplest form?

- [A]  $\frac{x}{x^2}$  [B]  $\frac{x^2 - 6x + 9}{x^2 - x - 6}$   
[C]  $\frac{9}{x^2 + 9}$  [D]  $\frac{x^2 - 4}{x + 2}$

11. 080323b, P.I. A2.A.17

Express in simplest form:  $\frac{\frac{x}{4} - \frac{4}{x}}{1 - \frac{4}{x}}$

12. 060713b, P.I. A2.A.17

The expression  $\frac{\frac{1}{3} - \frac{1}{x}}{\frac{3}{x} - 1}$  is equivalent to

- [A] 3 [B]  $\frac{1}{3}$  [C] -3 [D]  $-\frac{1}{3}$

13. 010522b  
If  $2 + 3i$  is one root of a quadratic equation with real coefficients, what is the sum of the roots of the equation?
14. 060819b, P.I. A2.N.9  
The expression  $i^{100} + i^{101} + i^{102}$  equals  
[A]  $-i$  [B]  $i$  [C]  $-1$  [D]  $1$
15. 080420b, P.I. A2.N.5  
The expression  $\frac{11}{\sqrt{3}-5}$  is equivalent to  
[A]  $\frac{\sqrt{3}+5}{2}$  [B]  $\frac{-\sqrt{3}-5}{2}$   
[C]  $\frac{\sqrt{3}-5}{2}$  [D]  $\frac{-\sqrt{3}+5}{2}$
16. 010416b, P.I. A2.A.2  
Which statement must be true if a parabola represented by the equation  $y = ax^2 + bx + c$  does not intersect the  $x$ -axis?  
[A]  $b^2 - 4ac > 0$ , and  $b^2 - 4ac$  is not a perfect square.  
[B]  $b^2 - 4ac = 0$  [C]  $b^2 - 4ac < 0$   
[D]  $b^2 - 4ac > 0$ , and  $b^2 - 4ac$  is a perfect square.
17. 060325b  
Express the following rational expression in simplest form:  $\frac{9-x^2}{10x^2-28x-6}$
18. 010516b, P.I. A2.N.5  
The expression  $\frac{7}{3-\sqrt{2}}$  is equivalent to  
[A]  $\frac{21+\sqrt{2}}{7}$  [B]  $3+\sqrt{2}$   
[C]  $\frac{3+\sqrt{2}}{7}$  [D]  $3-\sqrt{2}$
19. 080606b, P.I. A2.N.5  
The expression  $\frac{12}{3+\sqrt{3}}$  is equivalent to  
[A]  $2+\sqrt{3}$  [B]  $4-2\sqrt{3}$   
[C]  $6-2\sqrt{3}$  [D]  $12-\sqrt{3}$
20. 080307b, P.I. A2.N.5  
Which expression is equal to  $\frac{2+\sqrt{3}}{2-\sqrt{3}}$ ?  
[A]  $\frac{1-4\sqrt{3}}{7}$  [B]  $7+4\sqrt{3}$   
[C]  $1-4\sqrt{3}$  [D]  $\frac{7+4\sqrt{3}}{7}$
21. 060423b, P.I. A2.A.2  
Find all values of  $k$  such that the equation  $3x^2 - 2x + k = 0$  has imaginary roots.
22. 080817b, P.I. A2.A.58  
What is the value of  $\csc(\text{Arc sin } \frac{3}{4})$ ?  
[A]  $\frac{4}{\sqrt{7}}$  [B]  $\frac{3}{4}$  [C]  $\frac{4}{3}$  [D]  $\frac{\sqrt{7}}{4}$
23. 080425b, P.I. A2.A.17  
Express in simplest form:  $\frac{\frac{1}{r} - \frac{1}{s}}{\frac{r^2}{s^2} - 1}$
24. 010513b, P.I. A2.A.2  
The roots of the equation  $2x^2 - 8x - 4 = 0$  are  
[A] imaginary  
[B] real, irrational, and unequal  
[C] real, rational, and equal  
[D] real, rational, and unequal

25. 060823b, P.I. A2.A.17

Simplify:  $\frac{\frac{x-3}{x-3}}{x}$

26. 080210b, P.I. A2.N.5

Which expression represents the sum of

$$\frac{1}{\sqrt{3}} + \frac{1}{\sqrt{2}}?$$

[A]  $\frac{\sqrt{3} + \sqrt{2}}{3}$       [B]  $\frac{\sqrt{3} + \sqrt{2}}{2}$

[C]  $\frac{2}{\sqrt{5}}$       [D]  $\frac{2\sqrt{3} + 3\sqrt{2}}{6}$

27. 060813b

The value of  $\sqrt{x^2 - 9}$  is a real and irrational number when  $x$  is equal to

[A] 5      [B] 0      [C] 4      [D] -3

28. 080422b, P.I. A2.N.9

Express  $\sqrt{-48} + 3.5 + \sqrt{25} + \sqrt{-27}$  in simplest  $a + bi$  form.

29. 080220b, P.I. A2.A.17

Which expression is equivalent to the

complex fraction  $\frac{\frac{x}{x+2}}{1 - \frac{x}{x+2}}$ ?

[A]  $\frac{2x}{x+2}$       [B]  $\frac{x}{2}$       [C]  $\frac{2}{x}$       [D]  $\frac{2x}{x^2 + 4}$

30. 010313b, P.I. A2.A.2

If the roots of  $ax^2 + bx + c = 0$  are real, rational, and equal, what is true about the graph of the function  $y = ax^2 + bx + c$ ?

[A] It lies entirely above the  $x$ -axis.

[B] It lies entirely below the  $x$ -axis.

[C] It intersects the  $x$ -axis in two distinct points.

[D] It is tangent to the  $x$ -axis.

31. 080122b, P.I. A2.N.9

Show that the product of  $a + bi$  and its conjugate is a real number.

32. 060401b, P.I. A2.N.9

What is the sum of  $2 - \sqrt{-4}$  and  $-3 + \sqrt{-16}$  expressed in simplest  $a + bi$  form?

[A]  $-1 + i\sqrt{20}$       [B]  $-14 + i$

[C]  $-1 + 2i$       [D]  $-1 + 12i$

33. fall9909b

Which is the correct arrangement of these terms in order of value, from smallest to greatest?

[A]  $3\sqrt{2}$ ,  $4\frac{1}{8}$ ,  $|-4.24|$ ,  $\sqrt[3]{75}$

[B]  $4\frac{1}{8}$ ,  $|-4.24|$ ,  $\sqrt[3]{75}$ ,  $3\sqrt{2}$

[C]  $4\frac{1}{8}$ ,  $\sqrt[3]{75}$ ,  $|-4.24|$ ,  $3\sqrt{2}$

[D]  $\sqrt[3]{75}$ ,  $|-4.24|$ ,  $4\frac{1}{8}$ ,  $3\sqrt{2}$

34. 010905b, P.I. A2.N.7

Which expression is equivalent to  $i^{55}$ ?

[A]  $-1$       [B]  $i$       [C]  $-i$       [D]  $1$

35. 060307b, P.I. A2.A.2  
The roots of the equation  $ax^2 + 4x = -2$  are real, rational, and equal when  $a$  has a value of  
[A] 3 [B] 2 [C] 1 [D] 4
36. 080716b, P.I. A2.N.5  
The expression  $\frac{2}{1-\sqrt{3}}$  is equivalent to  
[A]  $-1+\sqrt{3}$  [B]  $1-\sqrt{3}$   
[C]  $1+\sqrt{3}$  [D]  $-1-\sqrt{3}$
37. fall9906b, P.I. A2.N.5  
Which expression is equivalent to  $\frac{\sqrt{7}+\sqrt{2}}{\sqrt{7}-\sqrt{2}}$ ?  
[A] -1 [B]  $\frac{9+2\sqrt{14}}{5}$   
[C]  $\frac{11+\sqrt{2}}{14}$  [D]  $\frac{9}{5}$
38. fall9921b  
Show that the following can be ordered from smallest to largest for all  $x > 1$ . Describe the method you used and state the correct order.  
 $1, x, \sqrt{x}, \frac{1}{x},$  and  $\frac{1}{\sqrt{x}}$
39. 010402b  
The expression  $\frac{\sec \theta}{\csc \theta}$  is equivalent to  
[A]  $\sin \theta$  [B]  $\frac{\cos \theta}{\sin \theta}$   
[C]  $\frac{\sin \theta}{\cos \theta}$  [D]  $\cos \theta$
40. 010714b, P.I. A2.A.25  
Which quadratic equation has the roots  $3+i$  and  $3-i$ ?  
[A]  $x^2 + 6x - 10 = 0$  [B]  $x^2 - 6x - 8 = 0$   
[C]  $x^2 + 6x + 8 = 0$  [D]  $x^2 - 6x + 10 = 0$
41. 010415b, P.I. A2.N.9  
If  $f(x) = x^3 - 2x^2$ , then  $f(i)$  is equivalent to  
[A]  $-2 - i$  [B]  $-2 + i$  [C]  $2 + i$  [D]  $2 - i$
42. 060207b  
Which statement is true for all real number values of  $x$ ?  
[A]  $\sqrt{x^2} = |x|$  [B]  $|x - 1| > (x - 1)$   
[C]  $\sqrt{x^2} = x$  [D]  $|x - 1| > 0$
43. 060513b, P.I. A2.N.9  
The expression  $\frac{2+i}{3+i}$  is equivalent to  
[A]  $\frac{6+5i}{8}$  [B]  $\frac{7+i}{10}$   
[C]  $\frac{7-5i}{10}$  [D]  $\frac{6+i}{8}$
44. 080814b, P.I. A2.A.2  
The roots of the equation  $5x^2 - 2x + 1 = 0$  are  
[A] real, irrational, and unequal  
[B] imaginary  
[C] real, rational, and equal  
[D] real, rational, and unequal
45. 010826b, P.I. A2.A.17  
Express in simplest form:  $\frac{x - \frac{4}{2+x}}{x}$
46. 080619b, P.I. A.A.16  
The expression  $\frac{3y^2 - 12y}{4y^2 - y^3}$  is equivalent to  
[A]  $-\frac{3}{y}$  [B]  $-\frac{9}{4}$  [C]  $\frac{3}{4} - \frac{12}{y^2}$  [D]  $\frac{3}{y}$

47. 060112b, P.I. A2.A.17

In a science experiment, when resistor  $A$  and resistor  $B$  are connected in a parallel circuit, the total resistance is  $\frac{1}{\frac{1}{A} + \frac{1}{B}}$ . This complex fraction is equivalent to

[A]  $\frac{AB}{A+B}$  [B]  $A+B$  [C]  $AB$  [D]  $1$

48. 010909b, P.I. A2.A.42

If  $f(x) = 3x - 5$  and  $g(x) = x - 9$ , which expression is equivalent to  $(f \circ g)(x)$ ?

[A]  $3x - 32$  [B]  $4x - 14$   
[C]  $3x - 14$  [D]  $3x^2 - 32x + 45$

49. 010206b, P.I. A2.A.17

The expression  $\frac{\frac{a-b}{b} - \frac{a}{1}}{\frac{1}{a} + \frac{1}{b}}$  is equivalent to

[A]  $\frac{a-b}{ab}$  [B]  $a+b$   
[C]  $a-b$  [D]  $ab$

50. 010902b, P.I. A2.N.5

The expression  $\frac{5}{3+\sqrt{2}}$  is equivalent to

[A]  $\frac{\sqrt{2}-15}{3}$  [B]  $\frac{15-5\sqrt{2}}{7}$   
[C]  $\frac{5\sqrt{2}-15}{5}$  [D]  $15-5\sqrt{2}$

51. 010705b, P.I. A2.N.7

The expression  $i^{25}$  is equivalent to

[A]  $-1$  [B]  $-i$  [C]  $1$  [D]  $i$

52. 080211b, P.I. A2.A.2

Which equation has imaginary roots?

[A]  $x^2 - 1 = 0$  [B]  $x^2 + x + 1 = 0$   
[C]  $x^2 - x - 1 = 0$  [D]  $x^2 - 2 = 0$

53. 060719b

If  $2 + i$  and  $2 - i$  are the roots of the equation  $x^2 - 4x + c = 0$ , what is the value of  $c$ ?

[A]  $4$  [B]  $5$  [C]  $-4$  [D]  $-5$

54. 060518b, P.I. A2.A.2

Which equation has imaginary roots?

[A]  $(2x+1)(x-3) = 7$  [B]  $x(5+x) = 8$   
[C]  $x(x+6) = -10$  [D]  $x(5-x) = -3$

55. 060628b, P.I. A2.A.17

Simplify for all values of  $a$  for which the

expression is defined:  $1 - \frac{2}{\frac{4}{a^2} - 1}$

56. 010830b, P.I. A2.A.21

Write a quadratic equation such that the sum of its roots is  $-5$  and the product of its roots is  $6$ . What are the roots of this equation?

57. 060415b, P.I. A2.A.17

The expression  $\frac{\frac{1}{x} + \frac{1}{y}}{\frac{1}{x^2} - \frac{1}{y^2}}$  is equivalent to

[A]  $\frac{xy}{y-x}$  [B]  $y-x$   
[C]  $\frac{xy}{x-y}$  [D]  $\frac{y-x}{xy}$

58. 080107b, P.I. G.G.53

The new corporate logo created by the design engineers at Magic Motors is shown in the accompanying diagram.

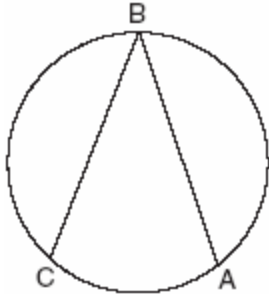

If chords  $\overline{BA}$  and  $\overline{BC}$  are congruent and  $m\widehat{BC} = 140$ , what is  $m\angle B$ ?

- [A] 140 [B] 280 [C] 40 [D] 80

59. 060317b, P.I. A2.A.17

In simplest form,  $\frac{\frac{1}{x^2} - \frac{1}{y^2}}{\frac{1}{y} + \frac{1}{x}}$  is equal to

- [A]  $\frac{x-y}{xy}$  [B]  $y-x$   
[C]  $\frac{y-x}{xy}$  [D]  $x-y$

60. 060712b, P.I. A.A.16

Written in simplest form, the expression

$$\frac{x^2y-4}{4-x^2y}$$

is:

- [A] 1 [B]  $\frac{x^2y-4}{4-x^2y}$  [C] -1 [D] 0

61. 080513b, P.I. A2.A.17

When simplified, the complex fraction

$$\frac{1 + \frac{1}{\frac{x}{1-x}}}{\frac{1}{x}}, x \neq 0, \text{ is equivalent to}$$

- [A] -1 [B]  $\frac{1}{x-1}$  [C] 1 [D]  $\frac{1}{1-x}$

62. 010405b, P.I. A2.N.5

The expression  $\frac{7}{2-\sqrt{3}}$  is equivalent to

- [A]  $\frac{2+\sqrt{3}}{7}$  [B]  $14-7\sqrt{3}$   
[C]  $\frac{14+\sqrt{3}}{7}$  [D]  $14+7\sqrt{3}$

63. 060202b, P.I. A.A.16

For all values of  $x$  for which the expression is defined,  $\frac{2x+x^2}{x^2+5x+6}$  is equivalent to

- [A]  $\frac{x}{x+3}$  [B]  $\frac{1}{x+3}$   
[C]  $\frac{1}{x+2}$  [D]  $\frac{x}{x+2}$

64. 010614b, P.I. A2.A.2

The roots of the equation  $2x^2 - 5 = 0$  are

- [A] real, rational, and unequal  
[B] real, rational, and equal  
[C] real and irrational [D] imaginary

65. 060820b, P.I. A2.A.21

Which equation has roots whose sum is 3 and whose product is -4?

- [A]  $x^2 + 4x - 3 = 0$  [B]  $x^2 - 4x + 3 = 0$   
[C]  $x^2 - 3x - 4 = 0$  [D]  $x^2 + 3x - 4 = 0$

66. 080612b, P.I. A.A.8  
For which equation is the sum of the roots equal to the product of the roots?  
[A]  $x^2 - 4x + 4 = 0$  [B]  $x^2 + x + 1 = 0$   
[C]  $x^2 + 3x - 6 = 0$  [D]  $x^2 - 8x - 4 = 0$
67. 060614b  
What is the multiplicative inverse of  $3i$ ?  
[A]  $-3$  [B]  $\frac{1}{3}$  [C]  $-\frac{i}{3}$  [D]  $-3i$
68. 080718b, P.I. A2.A.25  
Which equation has the complex number  $4 - 3i$  as a root?  
[A]  $x^2 - 6x + 25 = 0$  [B]  $x^2 - 8x + 25 = 0$   
[C]  $x^2 + 8x - 25 = 0$  [D]  $x^2 + 6x - 25 = 0$
69. 010919b, P.I. A2.A.21  
Juan has been told to write a quadratic equation where the sum of the roots is equal to  $-3$  and the product of the roots is equal to  $-9$ . Which equation meets these requirements?  
[A]  $(x + 3)(x + 9) = 0$   
[B]  $2x^2 + 6x - 18 = 0$   
[C]  $x^2 + 3x + 9 = 0$  [D]  $x^2 - 12x + 27 = 0$
70. 080702b, P.I. A2.N.9  
The expression  $3i(2i^2 - 5i)$  is equivalent to  
[A]  $-1 + 0i$  [B]  $-15 - 5i$   
[C]  $15 - 5i$  [D]  $15 - 6i$
71. 010613b, P.I. A2.N.5  
The expression  $\frac{5}{\sqrt{5}-1}$  is equivalent to  
[A]  $\frac{5\sqrt{5}-5}{4}$  [B]  $\frac{5}{4}$   
[C]  $\frac{5\sqrt{5}-5}{6}$  [D]  $\frac{5\sqrt{5}+5}{4}$

72. 080706b, P.I. A2.A.17  
Which expression is equivalent to the complex fraction  $\frac{\frac{1}{-a}}{\frac{1}{a}+1}$ ?  
[A]  $+1$  [B]  $1-a$   
[C]  $-(1-a)$  [D]  $-1$
73. 080825b, P.I. A.A.41  
Each year, the student council at Briarwood High School sponsors a community talent show to raise money. In previous years, the council has discovered that profit from ticket sales,  $P(x)$ , is a function of the amount charged per ticket,  $x$ , in dollars, as modeled by the equation  $P(x) = 120x - 12x^2$ . What amount should the council charge for a ticket to make the greatest profit? [The use of the grid is optional.]

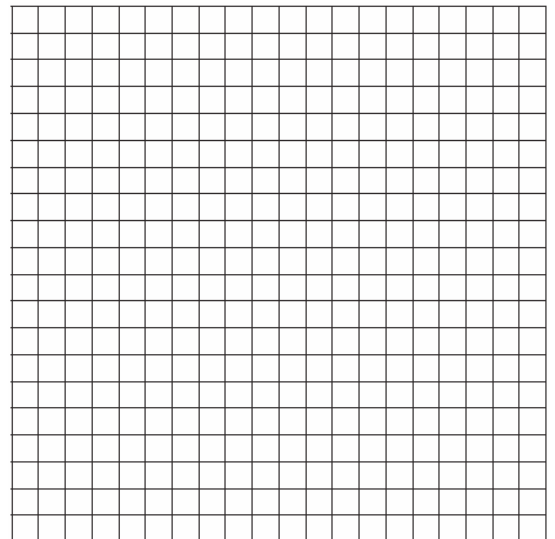

74. 080506b, P.I. A2.N.5  
The expression  $\frac{1}{5-\sqrt{13}}$  is equivalent to  
[A]  $\frac{5+\sqrt{13}}{12}$  [B]  $\frac{5+\sqrt{13}}{8}$   
[C]  $\frac{5+\sqrt{13}}{-8}$  [D]  $\frac{5+\sqrt{13}}{-12}$



75. 080320b, P.I. A2.A.2

In the equation  $ax^2 + 6x - 9 = 0$ , imaginary roots will be generated if

- [A]  $a < -1$                       [B]  $a < 1$ , only  
[C]  $-1 < a < 1$                 [D]  $a > -1$ , only

76. 010706b, P.I. A2.A.17

The expression  $\frac{\frac{1}{3} + \frac{1}{3x}}{\frac{1}{x} + \frac{1}{3}}$  is equivalent to

- [A]  $\frac{x+1}{x+3}$     [B]  $\frac{1}{3}$     [C]  $\frac{3x+3}{x+3}$     [D] 2

77. 060709b, P.I. A2.N.5

The fraction  $\frac{3}{\sqrt{6}-1}$  is equivalent to

- [A]  $3\sqrt{6} + 3$                       [B]  $3\sqrt{6} - 3$   
[C]  $\frac{3\sqrt{6}-3}{5}$                                 [D]  $\frac{3\sqrt{6}+3}{5}$

78. 010708b, P.I. A2.N.5

The expression  $\frac{4}{5-\sqrt{13}}$  is equivalent to

- [A]  $\frac{5+\sqrt{13}}{3}$                                 [B]  $\frac{5-\sqrt{13}}{3}$   
[C]  $\frac{2(5-\sqrt{13})}{19}$                                 [D]  $\frac{2(5+\sqrt{13})}{19}$

79. 060111b, P.I. A2.N.9

Melissa and Joe are playing a game with complex numbers. If Melissa has a score of  $5 - 4i$  and Joe has a score of  $3 + 2i$ , what is their total score?

- [A]  $8 - 6i$                                 [B]  $8 + 6i$   
[C]  $8 + 2i$                                 [D]  $8 - 2i$

80. 060219b, P.I. A2.A.2

The roots of the equation  $2x^2 - x = 4$  are

- [A] real and irrational  
[B] real, rational, and unequal  
[C] imaginary  
[D] real, rational, and equal

81. 080305b, P.I. A.A.16

Written in simplest form, the expression

$\frac{x^2y^2 - 9}{3 - xy}$  is equivalent to

- [A]  $\frac{1}{3+xy}$                                 [B]  $3+xy$   
[C]  $-(3+xy)$                             [D]  $-1$

1. 010901b, P.I. G.G.54

The parabola shown in the accompanying diagram undergoes a reflection in the  $y$ -axis.

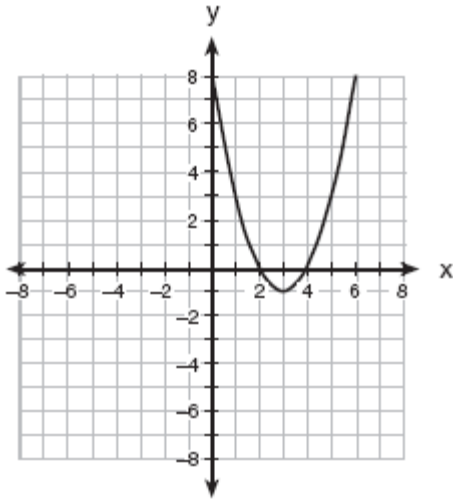

What will be the coordinates of the turning point after the reflection?

- [A] (-3,1)                      [B] (3,-1)  
[C] (-3,-1)                    [D] (3,1)

2. 060708b, P.I. A2.A.11

The volume of a soap bubble is represented by the equation  $V = 0.094\sqrt{A^3}$ , where  $A$  represents the surface area of the bubble. Which expression is also equivalent to  $V$ ?

- [A]  $0.094A^{\frac{2}{3}}$                       [B]  $(0.094A^3)^{\frac{1}{2}}$   
[C]  $0.094A^6$                         [D]  $0.094A^{\frac{3}{2}}$

3. 080216b

If the point  $(a, b)$  lies on the graph  $y = f(x)$ , the graph of  $y = f^{-1}(x)$  must contain point

- [A]  $(a,0)$                               [B]  $(0,b)$   
[C]  $(-a,-b)$                         [D]  $(b,a)$

4. 060315b, P.I. A2.N.9

What is the value of  $i^{99} - i^3$ ?

- [A] 0            [B]  $i^{96}$       [C] 1            [D]  $-i$

5. 010315b, P.I. A2.A.16

What is the sum of  $\frac{3}{x-3}$  and  $\frac{x}{3-x}$ ?

- [A] -1      [B] 0      [C]  $\frac{x+3}{x-3}$       [D] 1

6. fall9903b, P.I. A2.A.46

The graph below represents  $f(x)$ .

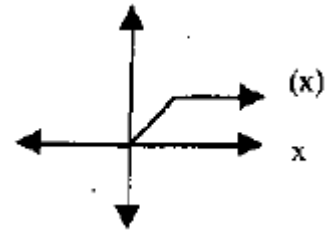

Which of the following is the graph of  $-f(x)$ ?

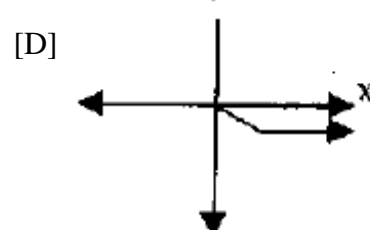
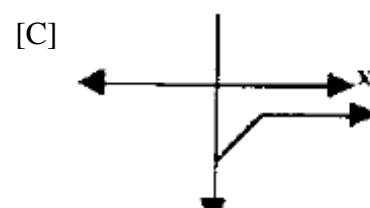
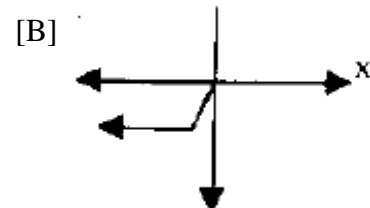
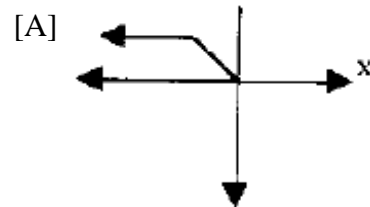

7. 080801b, P.I. G.G.61

Which transformation of  $y = 2^x$  results in the function  $y = 2^x - 2$ ?

- [A]  $T_{0,-2}$                       [B]  $r_{y\text{-axis}}$   
[C]  $r_{x\text{-axis}}$                     [D]  $T_{0,-1}$

8. 060809b, P.I. G.G.54

If point  $(5, 2)$  is rotated counterclockwise  $90^\circ$  about the origin, its image will be point

- [A]  $(2, 5)$                       [B]  $(2, -5)$   
[C]  $(-5, -2)$                 [D]  $(-2, 5)$

9. 060605b, P.I. A2.A.42

The temperature generated by an electrical circuit is represented by  $t = f(m) = 0.3m^2$ , where  $m$  is the number of moving parts. The resistance of the same circuit is represented by  $r = g(t) = 150 + 5t$ , where  $t$  is the temperature. What is the resistance in a circuit that has four moving parts?

- [A] 174    [B] 51    [C] 8,670    [D] 156

10. 080218b, P.I. A2.N.1

The expression  $\frac{3^{\frac{1}{3}}}{3^{-\frac{2}{3}}}$  is equivalent to

- [A]  $\frac{1}{\sqrt[3]{3}}$     [B] 1    [C]  $\sqrt{3}$     [D] 3

11. 060309b, P.I. G.G.61

If  $f(x) = \cos x$ , which graph represents  $f(x)$  under the composition  $r_{y\text{-axis}} \circ r_{x\text{-axis}}$ ?

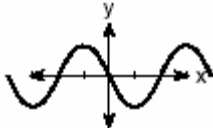
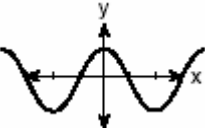
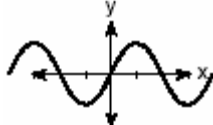
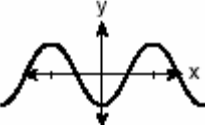
- [A]  [B]   
[C]  [D] 

12. 080219b, P.I. G.G.61

The accompanying graph represents the figure  $\square$ .

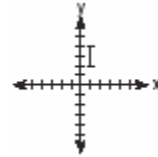

Which graph represents  $\square$  after a transformation defined by  $r_{y=x} \circ R_{90^\circ}$ ?

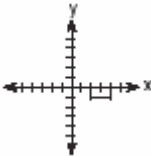
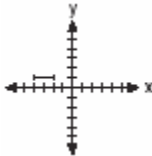
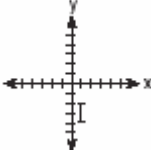
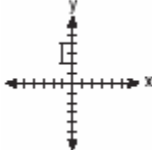
- [A]  [B]   
[C]  [D] 

13. 010506a, P.I. A.A.12

The product of  $(5ab)$  and  $(-2a^2b)^3$  is

- [A]  $-40a^7b^4$                       [B]  $-30a^6b^4$   
[C]  $-40a^6b^4$                       [D]  $-30a^7b^4$

14. 010711b

Which transformation could be used to make the graph of the equation  $y = \sin x$  coincide with the graph of the equation  $y = \cos x$ ?

- [A] point reflection    [B] rotation  
[C] translation            [D] dilation

15. 010926b, P.I. A.A.23

The volume of Earth can be calculated by using the formula  $V = \frac{4}{3}\pi r^3$ . Solve for  $r$  in terms of  $V$ .

16. 060304b, P.I. A2.N.9  
The relationship between voltage,  $E$ , current,  $I$ , and resistance,  $Z$ , is given by the equation  $E = IZ$ . If a circuit has a current  $I = 3 + 2i$  and a resistance  $Z = 2 - i$ , what is the voltage of this circuit?  
[A]  $8 + 7i$  [B]  $8 + i$  [C]  $4 - i$  [D]  $4 + i$

17. 010507b, P.I. G.G.54  
Which transformation is an example of an opposite isometry?  
[A]  $(x,y) \rightarrow (y,x)$   
[B]  $(x,y) \rightarrow (x + 3, y - 6)$   
[C]  $(x,y) \rightarrow (3x, 3y)$  [D]  $(x,y) \rightarrow (y, -x)$

18. 060816b, P.I. A2.A.16  
The expression  $\frac{2}{\sin x} - \frac{5}{\sin x - 1}$  is equivalent to  
[A]  $\frac{-3}{\sin x - 1}$  [B]  $\frac{-3 \sin x - 2}{\sin x - 1}$   
[C]  $\frac{-3 \sin x - 2}{\sin x(\sin x - 1)}$  [D]  $\frac{-3}{\sin x(\sin x - 1)}$

19. 010617b, P.I. A2.A.8  
When simplified, the expression  $(\sqrt[3]{m^4})(m^{-\frac{1}{2}})$  is equivalent to  
[A]  $\sqrt[4]{m^3}$  [B]  $\sqrt[5]{m^{-4}}$   
[C]  $\sqrt[3]{m^{-2}}$  [D]  $\sqrt[6]{m^5}$

20. 060217b, P.I. G.G.61  
Point  $P'$  is the image of point  $P(-3,4)$  after a translation defined by  $T_{(7,-1)}$ . Which other transformation on  $P$  would also produce  $P'$ ?  
[A]  $r_{y=-x}$  [B]  $r_{y\text{-axis}}$   
[C]  $R_{90^\circ}$  [D]  $R_{-90^\circ}$

21. 080102b, P.I. A2.A.1  
The solution set of  $|3x + 2| < 1$  contains  
[A] only negative real numbers  
[B] both positive and negative real numbers  
[C] no real numbers  
[D] only positive real numbers

22. 080512b  
Two complex numbers are graphed below.

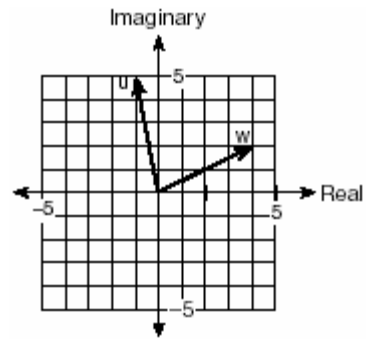

- What is the sum of  $w$  and  $u$ , expressed in standard complex number form?  
[A]  $3 + 7i$  [B]  $5 + 7i$   
[C]  $7 + 3i$  [D]  $-5 + 3i$

23. 060516b  
If  $(a^x)^{\frac{2}{3}} = \frac{1}{a^2}$ , what is the value of  $x$ ?  
[A] -3 [B] -1 [C] 1 [D] 2
24. 080120b, P.I. G.G.33  
A box contains one 2-inch rod, one 3-inch rod, one 4-inch rod, and one 5-inch rod. What is the maximum number of different triangles that can be made using these rods as sides?  
[A] 4 [B] 3 [C] 1 [D] 2
25. 010434b, P.I. A.A.18  
Express in simplest form:  
 $\frac{4x + 8}{x + 1} \cdot \frac{2 - x}{3x - 15} \div \frac{x^2 - 4}{2x^2 - 8x - 10}$

26. 010216b  
Which type of symmetry does the equation  $y = \cos x$  have?
- [A] line symmetry with respect to  $y = x$   
[B] point symmetry with respect to the origin  
[C] line symmetry with respect to the  $x$ -axis  
[D] point symmetry with respect to  $(\frac{\pi}{2}, 0)$

27. 080622b, P.I. A.A.23  
The volume of any spherical balloon can be found by using the formula  $V = \frac{4}{3}\pi r^3$ . Write an equation for  $r$  in terms of  $V$  and  $\pi$ .

28. 010219b, P.I. A2.N.9  
The expression  $(-1+i)^3$  is equivalent to
- [A]  $-1 - i$                       [B]  $-3i$   
[C]  $-2 - 2i$                     [D]  $2 + 2i$

29. 080109b  
A regular hexagon is inscribed in a circle. What is the ratio of the length of a side of the hexagon to the minor arc that it intercepts?
- [A]  $\frac{3}{\pi}$     [B]  $\frac{3}{6}$     [C]  $\frac{6}{\pi}$     [D]  $\frac{\pi}{6}$

30. 010419b  
What is the axis of symmetry of the graph of the equation  $x = y^2$ ?
- [A]  $x$ -axis                      [B] line  $y = x$   
[C]  $y$ -axis                      [D] line  $y = -x$

31. 010824b, P.I. A2.A.8  
Simplify the expression  $(m^6)^{\frac{2}{3}}$  and write your answer using a positive exponent.

32. 060701b, P.I. A2.A.46  
The accompanying graph represents the equation  $y = f(x)$ .

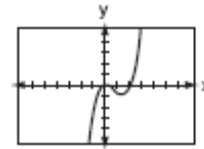

Which graph represents  $g(x)$ , if  $g(x) = -f(x)$ ?

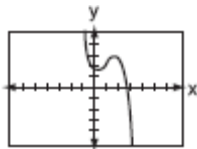
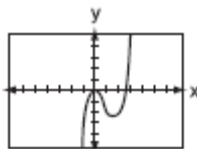
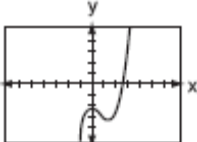
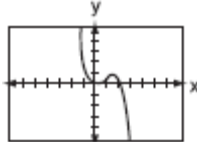
- [A] 
- [B] 
- [C] 
- [D] 

33. 060108b  
Fractal geometry uses the complex number plane to draw diagrams, such as the one shown in the accompanying graph.

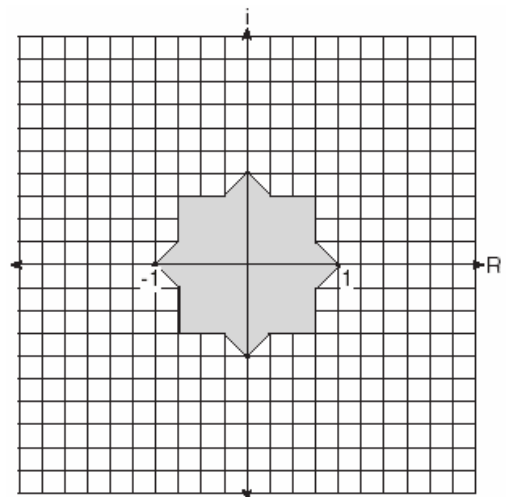

Which number is *not* included in the shaded area?

- [A]  $-0.5 - 0.5i$                       [B]  $-0.9$   
[C]  $-0.9 - 0.9i$                     [D]  $-0.5i$

34. 080103b, P.I. G.G.53

In the accompanying diagram, cabins  $B$  and  $G$  are located on the shore of a circular lake, and cabin  $L$  is located near the lake. Point  $D$  is a dock on the lake shore and is collinear with cabins  $B$  and  $L$ . The road between cabins  $G$  and  $L$  is 8 miles long and is tangent to the lake. The path between cabin  $L$  and dock  $D$  is 4 miles long.

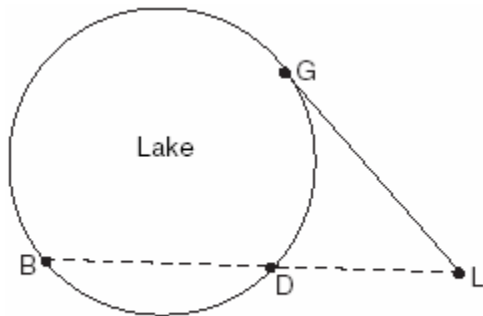

(Not drawn to scale)

What is the length, in miles, of  $\overline{BD}$ ?

- [A] 24 [B] 8 [C] 12 [D] 4

35. 080621b, P.I. A2.N.9

The complex number  $c + di$  is equal to  $(2 + i)^2$ . What is the value of  $c$ ?

36. 010518b, P.I. A2.N.9

The expression  $\frac{i^{16}}{i^3}$  is equivalent to

- [A]  $i$  [B]  $-1$  [C]  $1$  [D]  $-i$

37. 080725b, P.I. A.A.23

The slant height,  $\ell$ , of the conical water tank shown in the accompanying diagram is

$\ell = 3\sqrt{\frac{8v}{\pi}}$ . Solve for  $v$ , in terms of  $\ell$  and  $\pi$ .



38. 060727b, P.I. A2.A.16

If  $f(x) = \frac{3x^2 - 27}{18x + 30}$  and  $g(x) = \frac{x^2 - 7x + 12}{3x^2 - 7x - 20}$ , find  $f(x) \div g(x)$  for all values of  $x$  for which the expression is defined and express your answer in simplest form.

39. 060810b, P.I. A2.N.8

What is the sum of  $5 - 3i$  and the conjugate of  $3 + 2i$ ?

- [A]  $2 - 5i$  [B]  $2 + 5i$   
[C]  $8 + 5i$  [D]  $8 - 5i$

40. 080105b, P.I. G.G.61

Which transformation is a direct isometry?

- [A]  $T_{2,5}$  [B]  $D_2$  [C]  $r_{y\text{-axis}}$  [D]  $D_{-2}$

41. 060404b

Which quadratic function is shown in the accompanying graph?

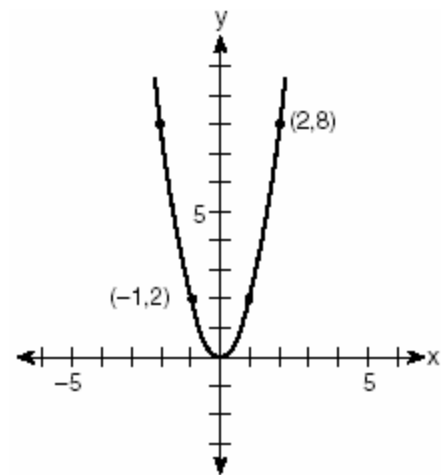

- [A]  $y = -\frac{1}{2}x^2$  [B]  $y = -2x^2$   
[C]  $y = 2x^2$  [D]  $y = \frac{1}{2}x^2$

42. 060215b, P.I. A2.N.9

What is the sum of  $\sqrt{-2}$  and  $\sqrt{-18}$ ?

- [A]  $2i\sqrt{5}$  [B]  $6i$   
[C]  $5i\sqrt{2}$  [D]  $4i\sqrt{2}$

43. 080322b, P.I. A2.N.1

Find the value of  $(x+2)^0 + (x+1)^{-\frac{2}{3}}$  when  $x = 7$ .

44. 060306b, P.I. G.G.54

What are the coordinates of point  $P$ , the image of point  $(3,-4)$  after a reflection in the line  $y = x$ ?

- [A]  $(4,-3)$                       [B]  $(3,4)$   
[C]  $(-4,3)$                       [D]  $(-3,4)$

45. fall9908b, P.I. A2.A.46

If  $y = 2^x$  and  $y = \left(\frac{1}{2}\right)^x$  are graphed on the same set of coordinate axes, which transformation would map one of these curves onto the other?

- [A] reflection in the  $x$ -axis  
[B] reflection in the  $y$ -axis  
[C] reflection in the line  $y = x$   
[D] reflection in the origin

46. 060821b

The entire graph of  $f(x)$  is symmetric with respect to the origin. If the accompanying graph represents  $f(x)$  for  $x \geq 0$ , sketch, on the same set of axes, the graph of  $f(x)$  for  $x \leq 0$ .

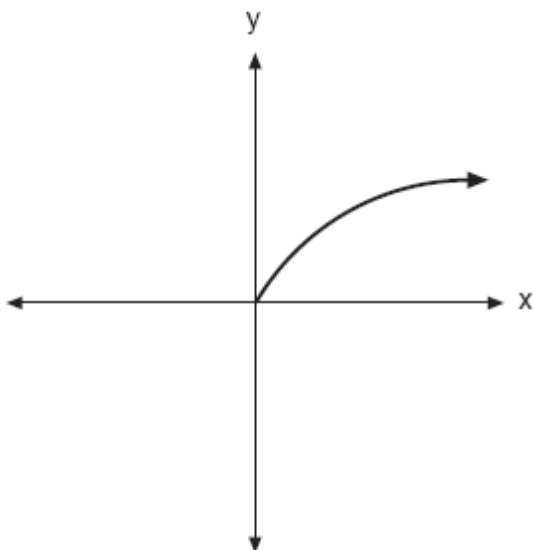

47. 060208b, P.I. A2.A.10

If  $x$  is a positive integer,  $4x^{\frac{1}{2}}$  is equivalent to

- [A]  $\frac{2}{x}$     [B]  $4\frac{1}{x}$     [C]  $2x$     [D]  $4\sqrt{x}$

48. 080108b, P.I. A.A.44

At Mogul's Ski Resort, the beginner's slope is inclined at an angle of  $12.3^\circ$ , while the advanced slope is inclined at an angle of  $26.4^\circ$ . If Rudy skis 1,000 meters down the advanced slope while Valerie skis the same distance on the beginner's slope, how much longer was the horizontal distance that Valerie covered?

- [A] 895.7 m                      [B] 231.6 m  
[C] 977.0 m                      [D] 81.3 m

49. 080111b, P.I. A.M.1

On a trip, a student drove 40 miles per hour for 2 hours and then drove 30 miles per hour for 3 hours. What is the student's average rate of speed, in miles per hour, for the whole trip?

- [A] 34    [B] 36    [C] 35    [D] 37

50. 010811b, P.I. A2.N.9

The expression  $\frac{10}{3+i}$  is equivalent to

- [A]  $3-i$                       [B]  $3+i$   
[C]  $\frac{15+5i}{4}$                       [D]  $\frac{5}{4}$

51. 010325b, P.I. A2.N.9

In an electrical circuit, the voltage,  $E$ , in volts, the current,  $I$ , in amps, and the opposition to the flow of current, called impedance,  $Z$ , in ohms, are related by the equation  $E = IZ$ . A circuit has a current of  $(3 + i)$  amps and an impedance of  $(-2 + i)$  ohms. Determine the voltage in  $a + bi$  form.

52. 080805b, P.I. A2.A.16

The expression  $\frac{6}{y-5} - \frac{y+5}{y^2-25}$  is equivalent to

[A]  $\frac{5y}{y+5}$                       [B]  $\frac{5y}{y-5}$

[C]  $\frac{5}{y-5}$                       [D]  $\frac{5}{y+5}$

53. 080811b

If  $10^k = x$ , then  $10^{3k}$  is equal to

[A]  $3+x$     [B]  $1,000x$     [C]  $3x$     [D]  $x^3$

54. 080413b, P.I. G.G.61

What is the image of point (1,1) under  $r_{x\text{-axis}} \circ R_{0,90^\circ}$ ?

[A] (1,-1)                      [B] (-1,-1)

[C] (1,1)                      [D] (-1,1)

55. 060611b, P.I. A.A.41

The graph of  $y = (x-3)^2$  is shifted left 4 units and down 2 units. What is the axis of symmetry of the transformed graph?

[A]  $x = 7$                       [B]  $x = 1$

[C]  $x = -1$                       [D]  $x = -2$

56. 060602b, P.I. A2.A.8

If  $f(x) = x^{-\frac{3}{2}}$ , then  $f(\frac{1}{4})$  is equal to

[A] -2    [B] 8    [C]  $-\frac{1}{8}$     [D] -4

57. 080415b, P.I. A.A.12

The expression  $\frac{(b^{2n+1})^3}{b^n \cdot b^{4n+3}}$  is equivalent to

[A]  $b^{-3n}$     [B]  $b^{-3n+1}$     [C]  $b^n$     [D]  $\frac{b^n}{2}$

58. 010733b, P.I. A.A.18

Perform the indicated operations and simplify completely:

$$\frac{x^2-9}{x^2-5x} \bullet \frac{5x-x^2}{x^2-x-12} \div \frac{x-4}{x^2-8x+16}$$

59. 080314b, P.I. A2.N.9

What is the product of  $5 + \sqrt{-36}$  and  $1 - \sqrt{-49}$ , expressed in simplest  $a + bi$  form?

[A]  $-37 + 41i$                       [B]  $47 - 29i$

[C]  $5 - 71i$                       [D]  $47 + 41i$

60. 060107b

Which inequality states that the temperature,  $t$ , in a room is less than  $3^\circ$  from  $68^\circ$ ?

[A]  $|68 + t| < 3$                       [B]  $|3 + t| < 68$

[C]  $|68 - t| < 3$                       [D]  $|3 - t| < 68$

61. 010621b, P.I. A2.A.42

If  $f(x) = 5x^2 - 1$  and  $g(x) = 3x - 1$ , find  $g(f(1))$ .

62. 010520b, P.I. G.G.61

If the coordinates of point A are (-2,3), what is the image of A under  $r_{y\text{-axis}} \circ D_3$ ?

[A] (9,-6)                      [B] (-6,-9)

[C] (6,9)                      [D] (5,6)

63. 080507b, P.I. A2.N.9

When expressed as a monomial in terms of  $i$ ,  $2\sqrt{-32} - 5\sqrt{-8}$  is equivalent to

[A]  $-2i\sqrt{2}$                       [B]  $18i\sqrt{2}$

[C]  $2\sqrt{2}i$                       [D]  $2i\sqrt{2}$

64. fall9928b, P.I. A2.A.25

Solve the equation  $x^2 = 6x - 12$  and express the roots in simplest  $a + bi$  form.

65. 080215b, P.I. A2.N.9

Expressed in simplest form,  $i^{16} + i^6 - 2i^5 + i^{13}$

[A] 1    [B]  $-i$     [C] -1    [D]  $i$



66. 080505b, P.I. A2.A.16

What is the sum of  $(y-5) + \frac{3}{y+2}$ ?

[A]  $\frac{y-2}{y+2}$                       [B]  $\frac{y^2-7}{y+2}$

[C]  $\frac{y^2-3y-7}{y+2}$                       [D]  $y-5$

67. 080626b, P.I. G.G.61

Given point  $A(-2,3)$ . State the coordinates of the image of  $A$  under the composition  $T_{-3,-4} \circ r_{x\text{-axis}}$ . [The use of the grid is optional.]

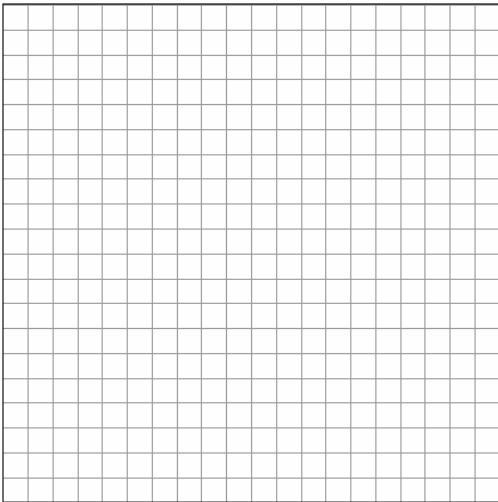

68. 060615b, P.I. A2.N.7

Mrs. Donahue made up a game to help her class learn about imaginary numbers. The winner will be the student whose expression is equivalent to  $-i$ . Which expression will win the game?

[A]  $i^{46}$     [B]  $i^{48}$     [C]  $i^{47}$     [D]  $i^{49}$

69. 060509b, P.I. A2.N.9

Impedance measures the opposition of an electrical circuit to the flow of electricity. The total impedance in a particular circuit is given by the formula  $Z_T = \frac{Z_1 Z_2}{Z_1 + Z_2}$ . What is the total impedance of a circuit,  $Z_T$ , if  $Z_1 = 1 + 2i$  and  $Z_2 = 1 - 2i$ ?

[A]  $\frac{5}{2}$                       [B]  $-\frac{3}{2}$                       [C] 1                      [D] 0

70. fall9907b, P.I. A2.A.27

Solve for  $x$ :  $64^{x-2} = 256^{2x}$

[A]  $\frac{-1}{5}$     [B]  $\frac{-6}{5}$     [C] 0    [D]  $\frac{-6}{11}$

71. 010803b, P.I. G.G.58

Under a dilation where the center of dilation is the origin, the image of  $A(-2,-3)$  is  $A'(-6,-9)$ . What are the coordinates of  $B'$ , the image of  $B(4,0)$  under the same dilation?

[A] (-4,0)                      [B] (12,0)  
[C] (-12,0)                      [D] (4,0)

72. 060210b, P.I. A2.A.42

If  $f(x) = 2x^2 + 4$  and  $g(x) = x - 3$ , which number satisfies  $f(x) = (f \circ g)(x)$ ?

[A] 4                      [B]  $\frac{3}{2}$                       [C] 5                      [D]  $\frac{3}{4}$

73. 010220b

The revenue,  $R(x)$ , from selling  $x$  units of a product is represented by the equation  $R(x) = 35x$ , while the total cost,  $C(x)$ , of making  $x$  units of the product is represented by the equation  $C(x) = 20x + 500$ . The total profit,  $P(x)$ , is represented by the equation  $P(x) = R(x) - C(x)$ . For the values of  $R(x)$  and  $C(x)$  given above, what is  $P(x)$ ?

[A]  $15x + 500$                       [B]  $15x$   
[C]  $15x - 500$                       [D]  $10x + 100$

74. 010825b, P.I. A2.N.10

If  $i = \sqrt{-1}$ , what is the value of the expression  $\sum_{n=1}^{20} i^{4n}$ ?

75. 060521b, P.I. A2.A.46

The graph of the function  $g(x)$  is shown on the accompanying set of axes. On the same set of axes, sketch the image of  $g(x)$  under the transformation  $D_2$ .

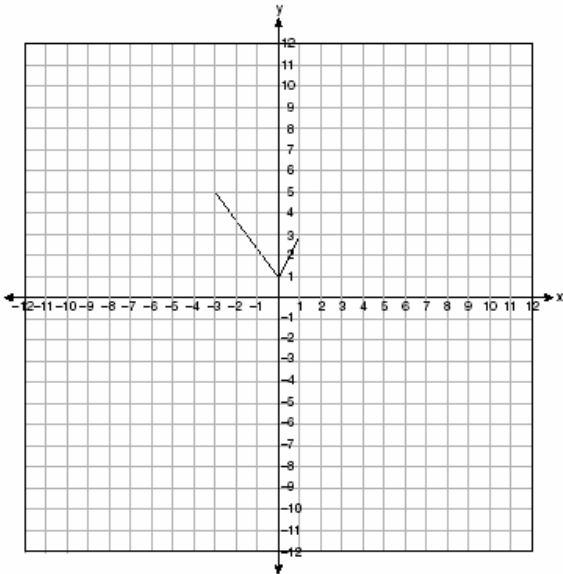

76. 080508b, P.I. G.G.54

The image of the origin under a certain translation is the point  $(2, -6)$ . The image of point  $(-3, -2)$  under the same translation is the point

- [A]  $(-\frac{3}{2}, \frac{1}{3})$       [B]  $(-1, -8)$   
[C]  $(-5, 4)$       [D]  $(-6, 12)$

77. 010928b, P.I. A.A.18

Perform the indicated operations and express in simplest form:

$$\frac{3x^2 + 12x - 15}{x^2 + 2x - 15} \div \frac{3x^2 - 3x}{3x - x^2}$$

78. 080601b, P.I. A2.N.1

The expression  $4^{\frac{1}{2}} \cdot 2^3$  is equal to

- [A] 4      [B]  $8^{\frac{3}{2}}$       [C] 16      [D]  $4^{\frac{3}{2}}$

79. 080328b, P.I. A2.A.25

Express, in simplest  $a + bi$  form, the roots of the equation  $x^2 + 5 = 4x$ .

80. 010627b, P.I. A2.A.25

In physics class, Taras discovers that the behavior of electrical power,  $x$ , in a particular circuit can be represented by the function  $f(x) = x^2 + 2x + 7$ . If  $f(x) = 0$ , solve the equation and express your answer in simplest  $a + bi$  form.

81. 080110b, P.I. A2.A.19

If  $\log 5 = a$ , then  $\log 250$  can be expressed as

- [A]  $10 + 2a$       [B]  $25a$   
[C]  $2a + 1$       [D]  $50a$

82. 060410b, P.I. A2.N.9

The expression  $i^0 \cdot i^1 \cdot i^2 \cdot i^3 \cdot i^4$  is equal to

- [A] 1      [B]  $-i$       [C]  $-1$       [D]  $i$

83. 060414b

Which function is symmetrical with respect to the origin?

- [A]  $y = \sqrt{x+5}$       [B]  $y = 5^x$   
[C]  $y = -\frac{5}{x}$       [D]  $y = |5-x|$

84. 060419b, P.I. A2.A.11

The expression  $\sqrt[4]{16a^6b^4}$  is equivalent to

- [A]  $2a^2b$       [B]  $4a^{\frac{3}{2}}b$   
[C]  $2a^{\frac{3}{2}}b$       [D]  $4a^2b$

85. 010217b, P.I. A2.N.1

The value of  $\left(\frac{3^0}{27^{\frac{2}{3}}}\right)^{-1}$  is

[A]  $-\frac{1}{9}$  [B] 9 [C] -9 [D]  $\frac{1}{9}$

86. 060524b, P.I. A2.A.16

Express in simplest form:  $\frac{1}{x} + \frac{1}{x+3}$

87. 080733b, P.I. A2.A.16

Express in simplest form:

$$\frac{2x}{x^2-4} \div \frac{4}{x^2-4x+4} + \frac{12}{x^2-4} \cdot \frac{2-x}{3}$$

88. 080407b, P.I. A2.N.9

When simplified,  $i^{27} + i^{34}$  is equal to

[A]  $i$  [B]  $i^{61}$  [C]  $-i-1$  [D]  $i-1$

1. 060101b  
An archer shoots an arrow into the air such that its height at any time,  $t$ , is given by the function  $h(t) = -16t^2 + kt + 3$ . If the maximum height of the arrow occurs at time  $t = 4$ , what is the value of  $k$ ?

[A] 8      [B] 128      [C] 4      [D] 64

2. 080212b, P.I. A2.A.19  
If  $\log k = c \log v + \log p$ ,  $k$  equals

[A]  $cv + p$                       [B]  $v^c p$   
[C]  $v^c + p$                       [D]  $(vp)^c$

3. 080824b, P.I. A2.A.17

Express in simplest form:  $\frac{1 - \frac{1}{x}}{x - 2 + \frac{1}{x}}$

4. 010502b  
The shaded portion of the accompanying map indicates areas of night, and the unshaded portion indicates areas of daylight at a particular moment in time.

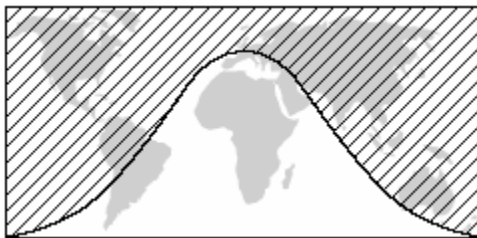

Which type of function best represents the curve that divides the area of night from the area of daylight?

[A] logarithmic                      [B] tangent  
[C] quadratic                        [D] cosine

5. 060409b, P.I. A2.A.19  
If  $\log_b x = y$ , then  $x$  equals

[A]  $\frac{y}{b}$       [B]  $b^y$       [C]  $y^b$       [D]  $y \cdot b$

6. 010620b, P.I. G.G.73  
The center of a circle represented by the equation  $(x - 2)^2 + (y + 3)^2 = 100$  is located in Quadrant

[A] IV      [B] III      [C] I      [D] II

7. 010430b, P.I. A2.A.73  
One force of 20 pounds and one force of 15 pounds act on a body at the same point so that the resultant force is 19 pounds. Find, to the nearest degree, the angle between the two original forces.

8. 010611b, P.I. A2.A.19  
The speed of sound,  $v$ , at temperature  $T$ , in degrees Kelvin, is represented by the equation  $v = 1087\sqrt{\frac{T}{273}}$ . Which expression is equivalent to  $\log v$ ?

[A]  $1087(\frac{1}{2}\log T - \frac{1}{2}\log 273)$   
[B]  $\log 1087 + \frac{1}{2}\log T - \frac{1}{2}\log 273$   
[C]  $\log 1087 + 2\log(T + 273)$   
[D]  $1087 + \frac{1}{2}\log T - \log 273$

9. 060721b, P.I. A.A.9  
A population of wolves in a county is represented by the equation  $P(t) = 80(0.98)^t$ , where  $t$  is the number of years since 1998. Predict the number of wolves in the population in the year 2008.

10. 060230b, P.I. A2.A.28  
Solve for  $x$ :  $\log_4(x^2 + 3x) - \log_4(x + 5) = 1$

11. 010429b, P.I. A2.A.27

The equation for radioactive decay is

$p = (0.5)^{\frac{t}{H}}$ , where  $p$  is the part of a substance with half-life  $H$  remaining radioactive after a period of time,  $t$ . A given substance has a half-life of 6,000 years. After  $t$  years, one-fifth of the original sample remains radioactive. Find  $t$ , to the *nearest thousand years*.

12. 060732b, P.I. A.A.41

The path of a rocket fired during a fireworks display is given by the equation

$s(t) = 64t - 16t^2$ , where  $t$  is the time, in seconds, and  $s$  is the height, in feet. What is the maximum height, in feet, the rocket will reach? In how many seconds will the rocket hit the ground? [The grid is optional.]

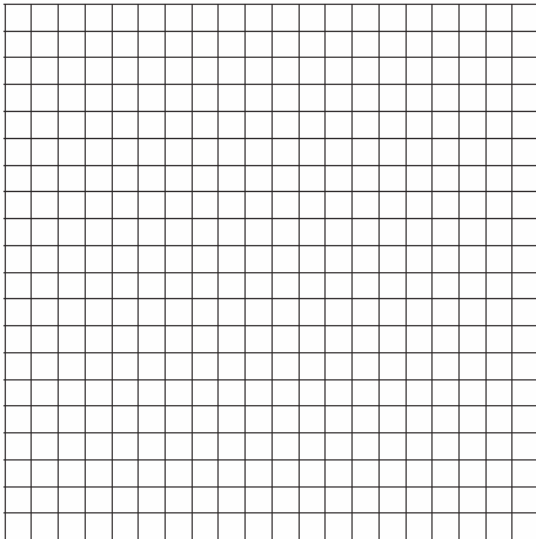

13. 010823b, P.I. A2.A.5

The amount of money each member of a band earns playing at a graduation party varies inversely as the number of members in the band. If the band has five members, each member earns \$70. Write an equation that models the relationship between the number of members in a band,  $n$ , and the amount each member earns,  $d$ . Use the equation to calculate the amount each member earns if there are four members in the band.

14. 080832b, P.I. A2.A.27

Kristen invests \$5,000 in a bank. The bank pays 6% interest compounded monthly. To the *nearest tenth of a year*, how long must she leave the money in the bank for it to double?

(Use the formula  $A = P(1 + \frac{r}{n})^{nt}$ , where  $A$  is the amount accrued,  $P$  is the principal,  $r$  is the interest rate,  $n = 12$ , and  $t$  is the length of time, in years.) [The use of the grid is optional.]

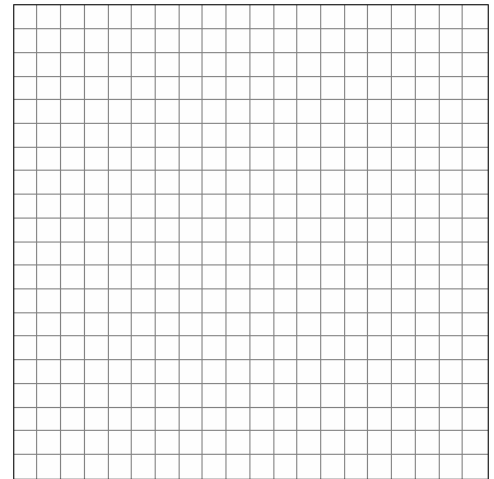

15. 010628b

On the accompanying grid, sketch the graphs of  $y = 2^x$  and  $3y = 7x + 3$  over the interval  $-3 \leq x \leq 4$ . Identify and state the coordinates of all points of intersection.

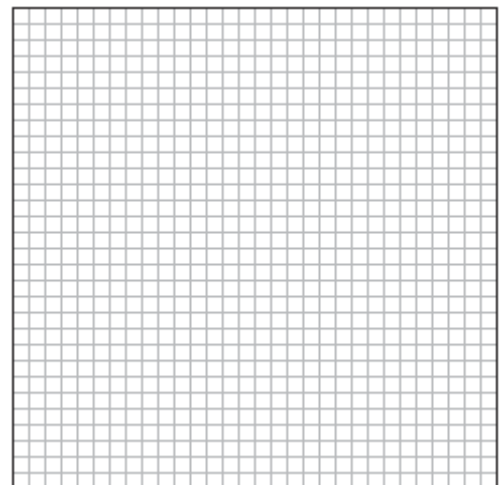

16. 010423b, P.I. A2.A.5  
A pulley that has a diameter of 8 inches is belted to a pulley that has a diameter of 12 inches. The 8-inch-diameter pulley is running at 1,548 revolutions per minute. If the speeds of the pulleys vary inversely to their diameters, how many revolutions per minute does the larger pulley make?

17. 060408b  
Which graph represents an inverse variation between stream velocity and the distance from the center of the stream?

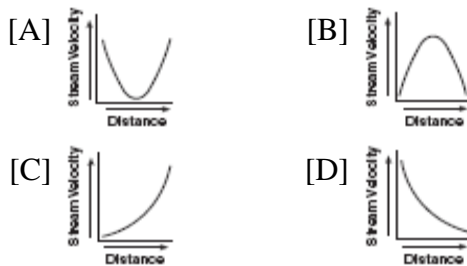

18. 080502b, P.I. A2.A.27  
The growth of bacteria in a dish is modeled by the function  $f(t) = 2^{\frac{t}{3}}$ . For which value of  $t$  is  $f(t) = 32$ ?

[A] 2      [B] 15      [C] 16      [D] 8

19. 010810b, P.I. A2.A.69  
A wave displayed by an oscilloscope is represented by the equation  $y = 3\sin x$ . What is the period of this function?

[A]  $3\pi$       [B] 2      [C]  $2\pi$       [D] 3

20. 060503b, P.I. A2.A.57  
Expressed as a function of a positive acute angle,  $\sin(-230^\circ)$  is equal to

[A]  $-\sin 50^\circ$       [B]  $\cos 50^\circ$   
[C]  $\sin 50^\circ$       [D]  $-\cos 50^\circ$

21. 010310b  
For a rectangular garden with a fixed area, the length of the garden varies inversely with the width. Which equation represents this situation for an area of 36 square units?

[A]  $x + y = 36$       [B]  $y = 36x$   
[C]  $x - y = 36$       [D]  $y = \frac{36}{x}$

22. 010303b, P.I. A.G.4  
Which equation represents the parabola shown in the accompanying graph?

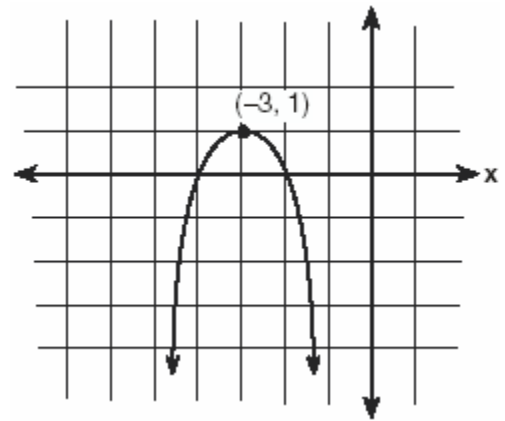

[A]  $f(x) = -(x - 3)^2 + 1$   
[B]  $f(x) = (x + 1)^2 - 3$   
[C]  $f(x) = -(x + 3)^2 + 1$   
[D]  $f(x) = -(x - 3)^2 - 3$

23. 080705b  
The flight paths of two Thunderbird jets are plotted on a Cartesian coordinate plane, and the equations of the jets' flight paths are represented by  $y = 2^x + 3$  and  $y = 0.5^x$ . The best approximation of the intersection of the flight paths is

[A] (0, 1)      [B] (-2, -1)  
[C] (-1.72, 3.3)      [D] (-1.50, 2.82)

24. 060512b  
Which equation, when graphed on a Cartesian coordinate plane, would best represent an elliptical racetrack?

[A]  $3x + 10y = 288,000$

[B]  $30xy = 288,000$

[C]  $3x^2 - 10y^2 = 288,000$

[D]  $3x^2 + 10y^2 = 288,000$

25. 010525b, P.I. A.A.9  
On January 1, 1999, the price of gasoline was \$1.39 per gallon. If the price of gasoline increased by 0.5% per month, what was the cost of one gallon of gasoline, to the *nearest cent*, on January 1 one year later?

26. 080624b, P.I. A2.A.28  
Solve for  $x$ :  $\log_b 36 - \log_b 2 = \log_b x$

27. 060102b, P.I. A2.A.28  
The magnitude ( $R$ ) of an earthquake is related to its intensity ( $I$ ) by  $R = \log\left(\frac{I}{T}\right)$ , where  $T$  is the threshold below which the earthquake is not noticed. If the intensity is doubled, its magnitude can be represented by

[A]  $\log I - \log T$       [B]  $2 \log I - \log T$

[C]  $\log 2 + \log I - \log T$

[D]  $2(\log I - \log T)$

28. 080404b, P.I. G.G.73  
A circle has the equation  $(x + 1)^2 + (y - 3)^2 = 16$ . What are the coordinates of its center and the length of its radius?

[A] (1,-3) and 4      [B] (1,-3) and 16

[C] (-1,3) and 16      [D] (-1,3) and 4

29. 010923b, P.I. A2.A.27  
Given a starting population of 100 bacteria, the formula  $b = 100(2^t)$  can be used to find the number of bacteria,  $b$ , after  $t$  periods of time. If each period is 15 minutes long, how many minutes will it take for the population of bacteria to reach 51,200?

30. 060406b, P.I. A2.A.41  
If  $f(x) = 4x^0 + (4x)^{-1}$ , what is the value of  $f(4)$ ?

[A]  $4\frac{1}{16}$     [B]  $1\frac{1}{16}$     [C] 0    [D] -12

31. 010527b  
On the accompanying grid, solve the following system of equations graphically:

$$y = -x^2 + 2x + 1$$

$$y = 2^x$$

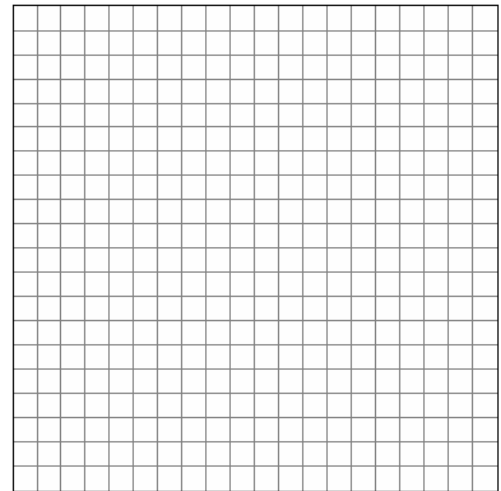

32. 080603b, P.I. A.A.41  
What is the minimum point of the graph of the equation  $y = 2x^2 + 8x + 9$ ?

[A] (-2,1)      [B] (2,33)

[C] (-2,-15)      [D] (2,17)

33. 010517b

The accompanying diagram shows the construction of a model of an elliptical orbit of a planet traveling around a star. Point  $P$  and the center of the star represent the foci of the orbit.

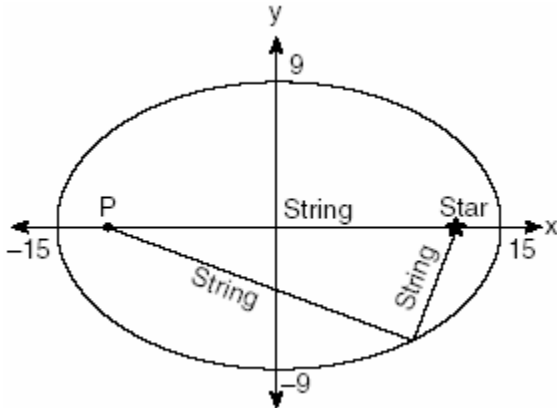

Which equation could represent the relation shown?

- [A]  $\frac{x^2}{225} + \frac{y^2}{81} = 1$       [B]  $\frac{x^2}{81} + \frac{y^2}{225} = 1$   
 [C]  $\frac{x^2}{15} - \frac{y^2}{9} = 1$       [D]  $\frac{x^2}{15} + \frac{y^2}{9} = 1$

34. 080332b

A company calculates its profit by finding the difference between revenue and cost. The cost function of producing  $x$  hammers is  $C(x) = 4x + 170$ . If each hammer is sold for \$10, the revenue function for selling  $x$  hammers is  $R(x) = 10x$ . How many hammers must be sold to make a profit? How many hammers must be sold to make a profit of \$100?

35. 060301b

For which value of  $x$  is  $y = \log x$  undefined?

- [A] 0      [B]  $\pi$       [C]  $\frac{1}{10}$       [D] 1.483

36. 010932b, P.I. A.G.9

On the accompanying grid, graph the following system of equations over the interval  $-6 \leq x \leq 6$ .

$$x^2 + y^2 = 25$$

$$xy = 12$$

State the points of intersection.

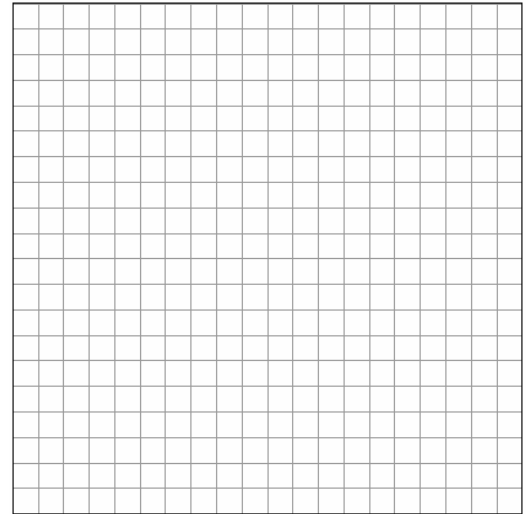

37. 080128b, P.I. A2.S.15

As shown in the accompanying diagram, a circular target with a radius of 9 inches has a bull's-eye that has a radius of 3 inches. If five arrows randomly hit the target, what is the probability that *at least* four hit the bull's-eye?

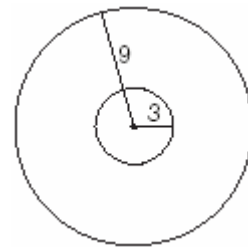

38. 060514b, P.I. A.A.41

For which quadratic equation is the axis of symmetry  $x = 3$ ?

- [A]  $y = x^2 + 6x + 3$       [B]  $y = x^2 + x + 3$   
 [C]  $y = -x^2 + 6x + 2$       [D]  $y = -x^2 + 3x + 5$



39. 060328b, P.I. A.G.9

The price of a stock,  $A(x)$ , over a 12-month period decreased and then increased according to the equation

$$A(x) = 0.75x^2 - 6x + 20, \text{ where } x \text{ equals the}$$

number of months. The price of another stock,  $B(x)$ , increased according to the equation  $B(x) = 2.75x + 1.50$  over the same 12-month period. Graph and label both equations on the accompanying grid. State all prices, to the *nearest dollar*, when both stock values were the same.

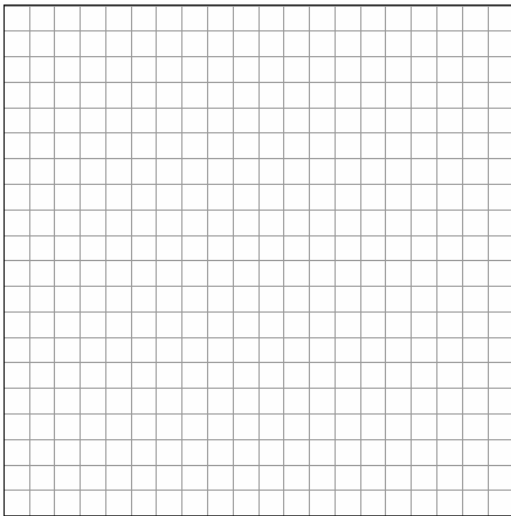

40. 010228b, P.I. A.A.7

At the local video rental store, José rents two movies and three games for a total of \$15.50. At the same time, Meg rents three movies and one game for a total of \$12.05. How much money is needed to rent a combination of one game and one movie?

41. 060104b

Camisha is paying a band \$330 to play at her graduation party. The amount each member earns,  $d$ , varies inversely as the number of members who play,  $n$ . The graph of the equation that represents the relationship between  $d$  and  $n$  is an example of

- [A] an ellipse                      [B] a hyperbola  
[C] a line                              [D] a parabola

42. 060430b, P.I. A.A.41

A baseball player throws a ball from the outfield toward home plate. The ball's height above the ground is modeled by the equation  $y = -16x^2 + 48x + 6$  where  $y$  represents height, in feet, and  $x$  represents time, in seconds. The ball is initially thrown from a height of 6 feet. How many seconds after the ball is thrown will it again be 6 feet above the ground? What is the maximum height, in feet, that the ball reaches? [The use of the grid is optional.]

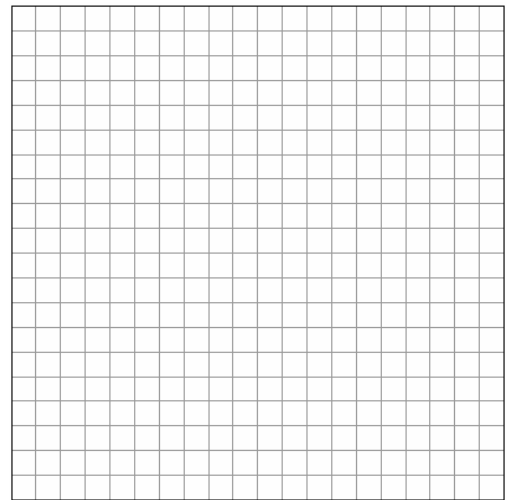

43. 060502b

If  $\sin \theta$  is negative and  $\cos \theta$  is negative, in which quadrant does the terminal side of  $\theta$  lie?

- [A] IV      [B] III      [C] I      [D] II

44. 060613b, P.I. A2.A.46

Which transformation best describes the relationship between the functions  $f(x) = 2^x$  and  $g(x) = \left(\frac{1}{2}\right)^x$ ?

- [A] reflection in the  $x$ -axis  
[B] reflection in the line  $y = x$   
[C] reflection in the  $y$ -axis  
[D] reflection in the origin

45. 080209b, P.I. A2.A.28  
In the equation  $\log_x 4 + \log_x 9 = 2$ ,  $x$  is equal to

[A]  $\sqrt{13}$  [B] 18 [C] 6 [D] 6.5

46. 060428b, P.I. A2.A.73  
Two equal forces act on a body at an angle of  $80^\circ$ . If the resultant force is 100 newtons, find the value of one of the two equal forces, to the *nearest hundredth of a newton*.

47. 060805b, P.I. A2.A.38  
Which relation is a function?

[A]  $2x^2 + 6y^2 = 1$  [B]  $x^2 + y^2 = 16$   
[C]  $y = x^2 + 3x - 4$  [D]  $y^2 = x^2 + 3x - 4$

48. 010334b, P.I. A2.A.73  
A ship captain at sea uses a sextant to sight an angle of elevation of  $37^\circ$  to the top of a lighthouse. After the ship travels 250 feet directly toward the lighthouse, another sighting is made, and the new angle of elevation is  $50^\circ$ . The ship's charts show that there are dangerous rocks 100 feet from the base of the lighthouse. Find, to the *nearest foot*, how close to the rocks the ship is at the time of the second sighting.

49. 010624b, P.I. A2.A.5  
The time it takes to travel to a location varies inversely to the speed traveled. It takes 4 hours driving at an average speed of 55 miles per hour to reach a location. To the *nearest tenth of an hour*, how long will it take to reach the same location driving at an average speed of 50 miles per hour?

50. 010424b, P.I. A.A.41  
When a current,  $I$ , flows through a given electrical circuit, the power,  $W$ , of the circuit can be determined by the formula  $W = 120I - 12I^2$ . What amount of current,  $I$ , supplies the maximum power,  $W$ ?

51. 010329b  
A building's temperature,  $T$ , varies with time of day,  $t$ , during the course of 1 day, as follows:  $T = 8 \cos t + 78$ . The air-conditioning operates when  $T \geq 80^\circ F$ . Graph this function for  $6 \leq t < 17$  and determine, to the *nearest tenth of an hour*, the amount of time in 1 day that the air-conditioning is on in the building.

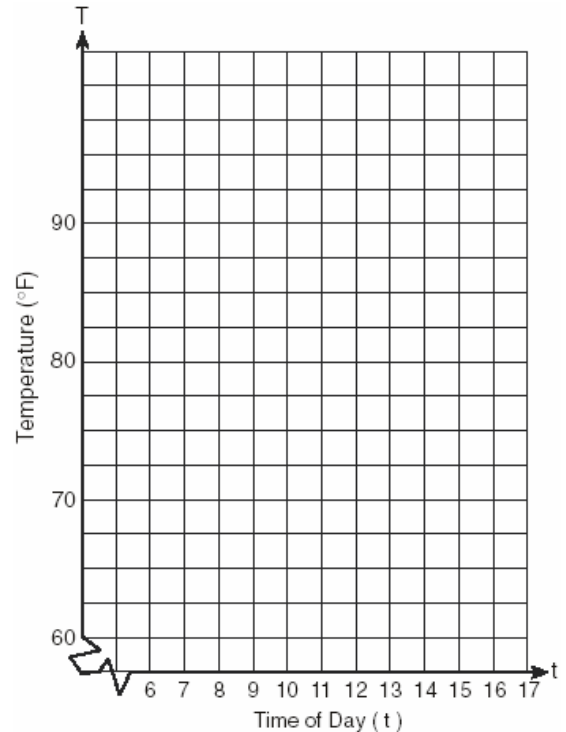

52. 060834b, P.I. A2.A.73  
Gerardo and Bennie are pushing a box. Gerardo pushes with a force of 50 pounds in an easterly direction, and Bennie pushes with a force of 39 pounds in a northeasterly direction. The resultant force forms an angle of  $32^\circ$  with the 39-pound force. Find the angle between the 50-pound force and the 39-pound force, to the *nearest tenth of a degree*. Find the magnitude of the resultant force, to the *nearest pound*.

53. 080607b, P.I. A2.A.19

The function  $y = 2^x$  is equivalent to

- [A]  $y = x \log 2$       [B]  $y = \log_2 x$   
[C]  $x = \log_2 y$       [D]  $x = y \log 2$

54. 080831b

A landscape architect's designs for a town park call for two parabolic-shaped walkways. When the park is mapped on a Cartesian coordinate plane, the pathways intersect at two points. If the equations of the curves of the walkways are  $y = 11x^2 + 23x + 210$  and  $y = -19x^2 - 7x + 390$ , determine the coordinates of the two points of intersection. [Only an algebraic solution can receive full credit.]

55. 080318b

A commercial artist plans to include an ellipse in a design and wants the length of the horizontal axis to equal 10 and the length of the vertical axis to equal 6. Which equation could represent this ellipse?

- [A]  $9x^2 - 25y^2 = 225$   
[B]  $3y = 20x^2$       [C]  $9x^2 + 25y^2 = 225$   
[D]  $x^2 + y^2 = 100$

56. 010701b

Which equation best represents the accompanying graph?

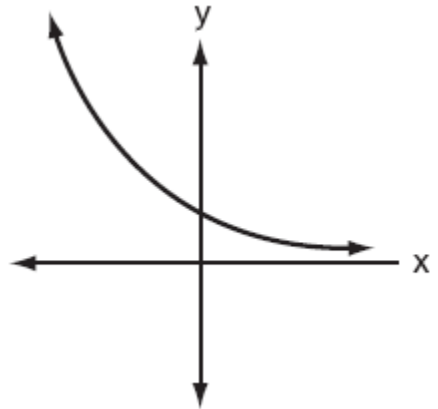

- [A]  $y = 2^x$       [B]  $y = x^2 + 2$   
[C]  $y = -2^x$       [D]  $y = 2^{-x}$

57. 080206b

An architect is designing a building to include an arch in the shape of a semi-ellipse (half an ellipse), such that the width of the arch is 20 feet and the height of the arch is 8 feet, as shown in the accompanying diagram.

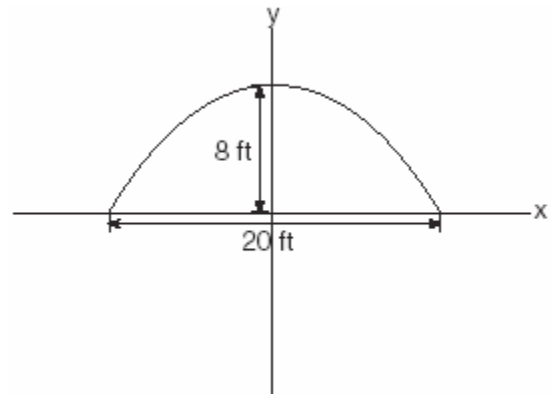

Which equation models this arch?

- [A]  $\frac{x^2}{64} + \frac{y^2}{100} = 1$       [B]  $\frac{x^2}{64} + \frac{y^2}{400} = 1$   
[C]  $\frac{x^2}{400} + \frac{y^2}{64} = 1$       [D]  $\frac{x^2}{100} + \frac{y^2}{64} = 1$

58. 060815b, P.I. A.N.4  
In 1995, the federal government paid off one-third of its debt. If the original amount of the debt was \$4,920,000,000,000, which expression represents the amount that was not paid off?
- [A]  $3.28 \times 10^{12}$       [B]  $1.64 \times 10^{12}$   
[C]  $1.64 \times 10^4$       [D]  $3.28 \times 10^8$

59. 010819b, P.I. A2.A.28  
If  $\log_x 9 = -2$ , what is the value of  $x$ ?
- [A]  $\frac{1}{3}$       [B] 81      [C]  $\frac{1}{81}$       [D] 3

60. 080530b, P.I. A2.A.28  
A hotel finds that its total annual revenue and the number of rooms occupied daily by guests can best be modeled by the function  $R = 3\log(n^2 + 10n)$ ,  $n > 0$ , where  $R$  is the total annual revenue, in millions of dollars, and  $n$  is the number of rooms occupied daily by guests. The hotel needs an annual revenue of \$12 million to be profitable. Graph the function on the accompanying grid over the interval  $0 < n \leq 100$ . Calculate the minimum number of rooms that must be occupied daily to be profitable.

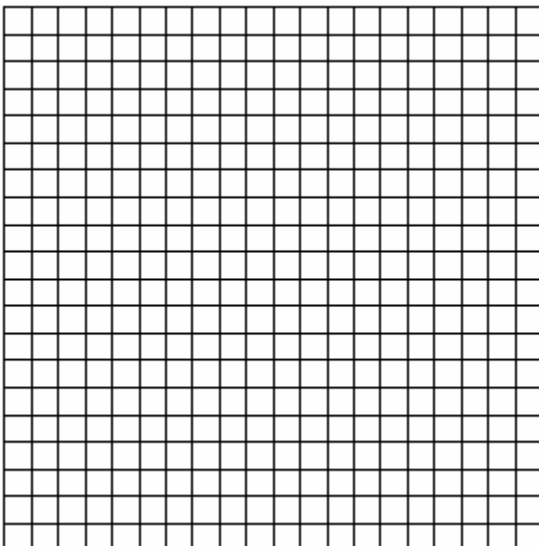

61. 080330b, P.I. A2.A.72  
A student attaches one end of a rope to a wall at a fixed point 3 feet above the ground, as shown in the accompanying diagram, and moves the other end of the rope up and down, producing a wave described by the equation  $y = a \sin bx + c$ . The range of the rope's height above the ground is between 1 and 5 feet. The period of the wave is  $4\pi$ . Write the equation that represents this wave.

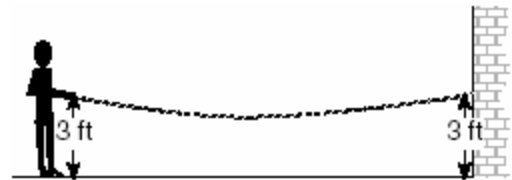

62. 080618b  
The accompanying diagram shows unit circle  $O$ , with radius  $OB = 1$ .

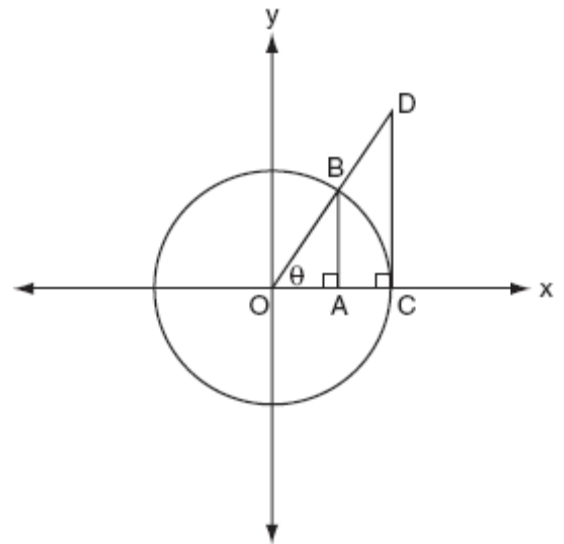

Which line segment has a length equivalent to  $\cos \theta$ ?

- [A]  $\overline{OA}$       [B]  $\overline{OC}$       [C]  $\overline{AB}$       [D]  $\overline{CD}$

63. 010828b, P.I. A2.A.27  
The number of houses in Central Village, New York, grows every year according to the function  $H(t) = 540(1.039)^t$ , where  $H$  represents the number of houses, and  $t$  represents the number of years since January 1995. A civil engineering firm has suggested that a new, larger well must be built by the village to supply its water when the number of houses exceeds 1,000. During which year will this first happen?

64. 060510b, P.I. A2.A.19  
If  $\log a = x$  and  $\log b = y$ , what is  $\log a\sqrt{b}$ ?

- [A]  $\frac{x+y}{2}$                       [B]  $x + \frac{y}{2}$   
[C]  $x + 2y$                       [D]  $2x + 2y$

65. 010907b, P.I. A.A.41  
The height of a swimmer's dive off a 10-foot platform into a diving pool is modeled by the equation  $y = 2x^2 - 12x + 10$ , where  $x$  represents the number of seconds since the swimmer left the diving board and  $y$  represents the number of feet above or below the water's surface. What is the farthest depth below the water's surface that the swimmer will reach?

- [A] 10 feet                      [B] 6 feet  
[C] 8 feet                      [D] 12 feet

66. 010916b  
If  $z_1 = -3 + 2i$  and  $z_2 = 4 - 3i$ , in which quadrant does the graph of  $(z_2 - z_1)$  lie?

- [A] IV    [B] III    [C] II    [D] I

67. 060726b  
On a stamp honoring the German mathematician Carl Gauss, several complex numbers appear. The accompanying graph shows two of these numbers. Express the sum of these numbers in  $a + bi$  form.

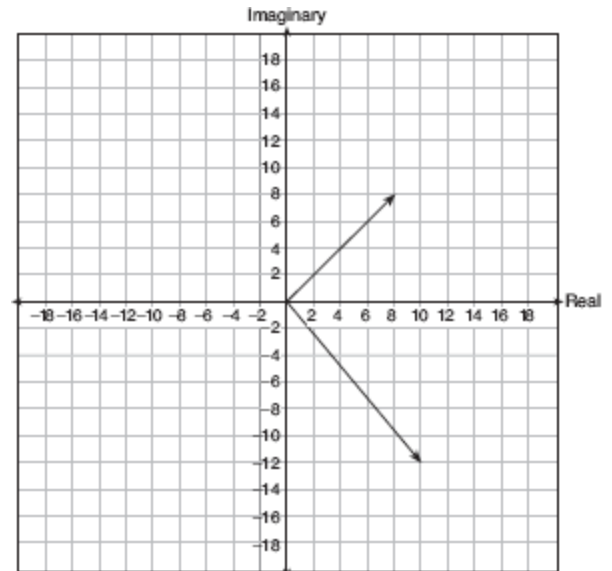

68. 010221b, P.I. A2.A.5  
Explain how a person can determine if a set of data represents inverse variation and give an example using a table of values.

69. 080620b

Which graph represents a quadratic function with a negative discriminant?

[A]

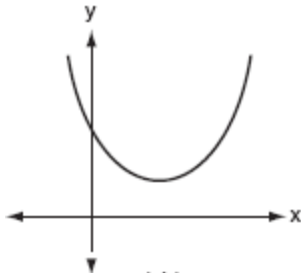

[B]

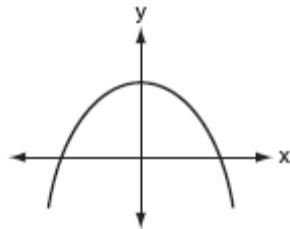

[C]

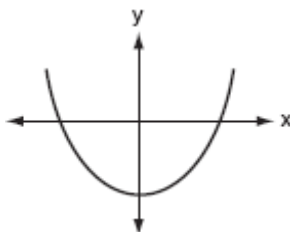

[D]

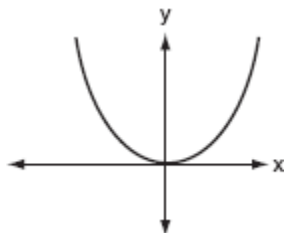

70. 080124b P.I. G.G.48

The accompanying diagram shows a semicircular arch over a street that has a radius of 14 feet. A banner is attached to the arch at points  $A$  and  $B$ , such that  $AE = EB = 5$  feet. How many feet above the ground are these points of attachment for the banner?

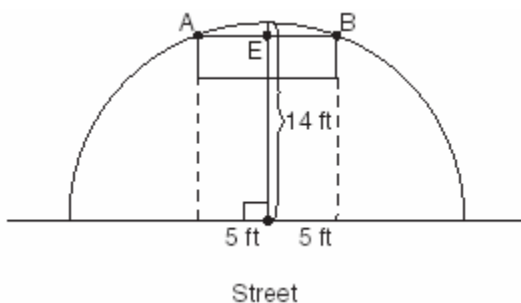

71. 010422b, P.I. A2.A.62

In the accompanying diagram, point  $P(0.6, -0.8)$  is on unit circle  $O$ . What is the value of  $\theta$ , to the nearest degree?

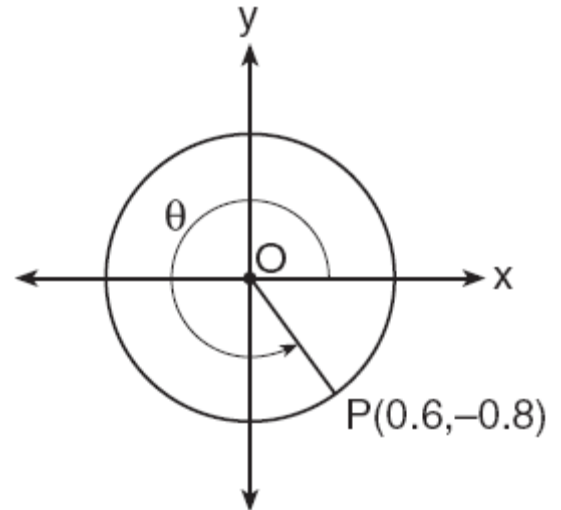

72. 060822b, P.I. A.A.41

A laundry owner's estimate of her weekly profits,  $p$ , in dollars, is given by the equation  $p = -4w^2 + 160w$ , where  $w$  represents the number of workers she hires. What is the number of workers she should hire in order to earn the greatest profit? [The use of the grid is optional.]

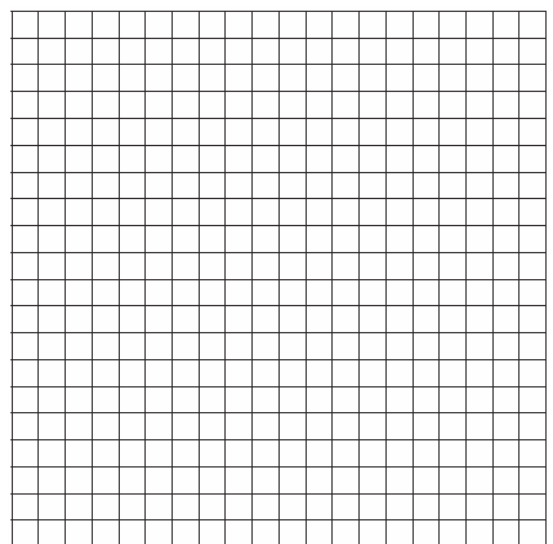

73. 060303b, P.I. A2.A.27

What is the value of  $x$  in the equation

$$81^{x+2} = 27^{5x+4}?$$

- [A]  $-\frac{2}{11}$    [B]  $-\frac{3}{2}$    [C]  $-\frac{4}{11}$    [D]  $\frac{4}{11}$

74. 010834b, P.I. A.G.4

The members of the Lincoln High School Prom Committee are trying to raise money for their senior prom. They plan to sell teddy bears. The senior advisor told them that the profit equation for their project is

$y = -0.1x^2 + 9x - 50$ , where  $x$  is the price at which the teddy bears will be sold and  $y$  is the profit, in dollars. On the grid below, graph this relationship so that  $0 \leq x \leq 90$  and  $-50 \leq y \leq 160$ . How much profit can the committee expect to make if they sell the teddy bears for \$20 each? What price should they charge for the teddy bears to make the maximum profit possible?

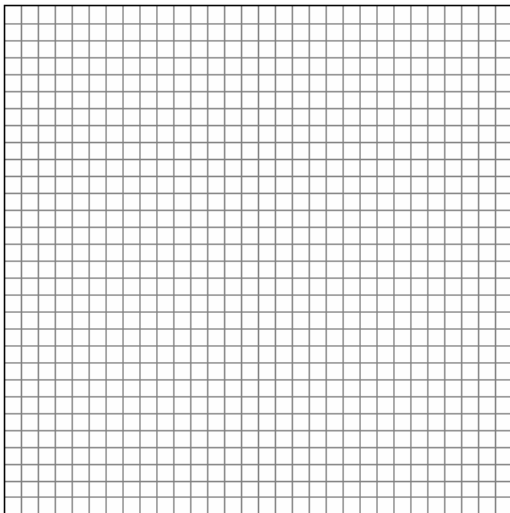

75. 080325b

Meteorologists can determine how long a storm lasts by using the function

$t(d) = 0.07d^{\frac{3}{2}}$ , where  $d$  is the diameter of the storm, in miles, and  $t$  is the time, in hours. If the storm lasts 4.75 hours, find its diameter, to the *nearest tenth of a mile*.

76. 080510b, P.I. A2.A.62

In the accompanying diagram of a unit circle, the ordered pair  $(-\frac{\sqrt{3}}{2}, -\frac{1}{2})$  represents the point where the terminal side of  $\theta$  intersects the unit circle.

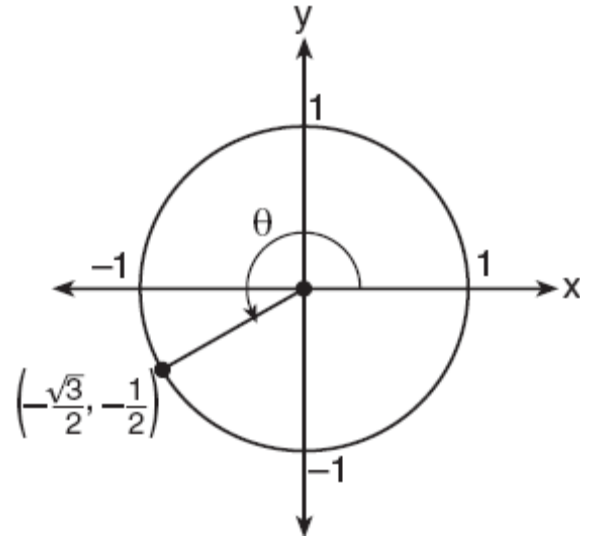

What is  $m\angle\theta$ ?

- [A] 225   [B] 233   [C] 240   [D] 210

77. 060120b

Through how many radians does the minute hand of a clock turn in 24 minutes?

- [A]  $0.8\pi$    [B]  $0.4\pi$   
[C]  $0.6\pi$    [D]  $0.2\pi$

78. 060225b, P.I. A.A.41

The equation  $W = 120I - 12I^2$  represents the power ( $W$ ), in watts, of a 120-volt circuit having a resistance of 12 ohms when a current ( $I$ ) is flowing through the circuit. What is the maximum power, in watts, that can be delivered in this circuit?

79. 080101b, P.I. A2.A.38

Which relation is *not* a function?

- [A]  $x = y^2 + 2x - 3$    [B]  $y = x^2 - 4x + 3$   
[C]  $x = 3y - 2$    [D]  $y = 2x + 4$

80. 060123b, P.I. A.A.7  
The cost of a long-distance telephone call is determined by a flat fee for the first 5 minutes and a fixed amount for each additional minute. If a 15-minute telephone call costs \$3.25 and a 23-minute call costs \$5.17, find the cost of a 30-minute call.
81. 080727b, P.I. A2.A.25  
A rectangular patio measuring 6 meters by 8 meters is to be increased in size to an area measuring 150 square meters. If both the width and the length are to be increased by the same amount, what is the number of meters, to the *nearest tenth*, that the dimensions will be increased?
82. 010324b, P.I. A2.A.28  
The relationship between the relative size of an earthquake,  $S$ , and the measure of the earthquake on the Richter scale,  $R$ , is given by the equation  $\log S = R$ . If an earthquake measured 3.2 on the Richter scale, what was its relative size to the *nearest hundredth*?
83. 060110b, P.I. G.G.71  
The center of a circular sunflower with a diameter of 4 centimeters is  $(-2, 1)$ . Which equation represents the sunflower?  
[A]  $(x - 2)^2 + (y + 1)^2 = 2$   
[B]  $(x + 2)^2 + (y - 1)^2 = 4$   
[C]  $(x + 2)^2 + (y - 1)^2 = 2$   
[D]  $(x - 2)^2 + (y - 1)^2 = 4$
84. 080207b, P.I. A2.A.5  
To balance a seesaw, the distance, in feet, a person is from the fulcrum is inversely proportional to the person's weight, in pounds. Bill, who weighs 150 pounds, is sitting 4 feet away from the fulcrum. If Dan weighs 120 pounds, how far from the fulcrum should he sit to balance the seesaw?  
[A] 3.5 ft [B] 4.5 ft [C] 3 ft [D] 5 ft
85. 010913b, P.I. A2.A.5  
Carol notices that the number of customers who visit her coffee shop varies inversely with the average daily temperature. Yesterday, the average temperature was  $40^\circ$  and she had 160 customers. If today's average temperature is  $25^\circ$ , how many customers should she expect?  
[A] 256 [B] 145 [C] 100 [D] 1,000
86. 080119b, P.I. A.M.1  
If Jamar can run  $\frac{3}{5}$  of a mile in 2 minutes 30 seconds, what is his rate in miles per minute?  
[A]  $\frac{4}{5}$  [B]  $4\frac{1}{6}$  [C]  $3\frac{1}{10}$  [D]  $\frac{6}{25}$
87. 080804b  
What is the graph of the function  $y = \sqrt{4 - x^2}$ ?  
[A] a circle whose radius is 2 and whose center is at the origin  
[B] a circle whose radius is 4 and whose center is at the origin  
[C] the upper half of a circle whose radius is 2 and whose center is at the origin  
[D] the upper half of a circle whose radius is 4 and whose center is at the origin
88. 080402b, P.I. A2.A.5  
The speed of a laundry truck varies inversely with the time it takes to reach its destination. If the truck takes 3 hours to reach its destination traveling at a constant speed of 50 miles per hour, how long will it take to reach the same location when it travels at a constant speed of 60 miles per hour?  
[A] 2 hours [B]  $2\frac{1}{3}$  hours  
[C]  $2\frac{2}{3}$  hours [D]  $2\frac{1}{2}$  hours



89. 080709b, P.I. A2.A.19

The equation used to determine the time it takes a swinging pendulum to return to its

starting point is  $T = 2\pi\sqrt{\frac{\ell}{g}}$ , where  $T$

represents time, in seconds,  $\ell$  represents the length of the pendulum, in feet, and  $g$  equals  $32 \text{ ft/sec}^2$ . How is this equation expressed in logarithmic form?

[A]  $\log T = 2 + \log \pi + \frac{1}{2} \log \ell - 16$

[B]  $\log T = \log 2 + \log \pi + \log \sqrt{\ell - 32}$

[C]  $\log T = \log 2 + \log \pi + \frac{1}{2} \log \ell - \log 16$

[D]  $\log T = \log 2 + \log \pi + \frac{1}{2} \log \ell - \frac{1}{2} \log 32$

90. 060520b

In the accompanying diagram,  $\overline{PR}$  is tangent to circle  $O$  at  $R$ ,  $\overline{QS} \perp \overline{OR}$ , and  $\overline{PR} \perp \overline{OR}$ .

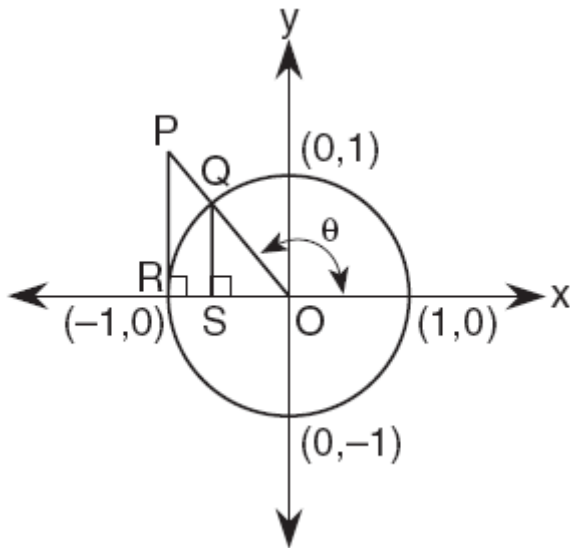

Which measure represents  $\sin \theta$ ?

- [A] QS    [B] SO    [C] PR    [D] RO

91. 080228b, P.I. A2.A.73

Two tow trucks try to pull a car out of a ditch. One tow truck applies a force of 1,500 pounds while the other truck applies a force of 2,000 pounds. The resultant force is 3,000 pounds. Find the angle between the two applied forces, rounded to the *nearest degree*.

92. 010632b, P.I. A2.A.27

The current population of Little Pond, New York, is 20,000. The population is *decreasing*, as represented by the formula  $P = A(1.3)^{-0.234t}$ , where  $P$  = final population,  $t$  = time, in years, and  $A$  = initial population. What will the population be 3 years from now? Round your answer to the *nearest hundred people*. To the *nearest tenth of a year*, how many years will it take for the population to reach half the present population? [The use of the grid is optional.]

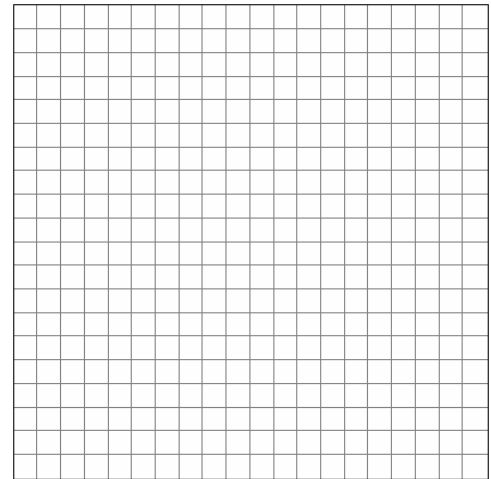

93. fall9916b, P.I. A.A.9

The population of Henderson City was 3,381,000 in 1994, and is growing at an annual rate of 1.8%. If this growth rate continues, what will the approximate population of Henderson City be in the year 2000?

- [A] 3,696,000                      [B] 3,831,000  
[C] 3,763,000                      [D] 3,798,000

94. 010724b

On the accompanying set of axes, graphically represent the sum of  $3 + 4i$  and  $-1 + 2i$ .

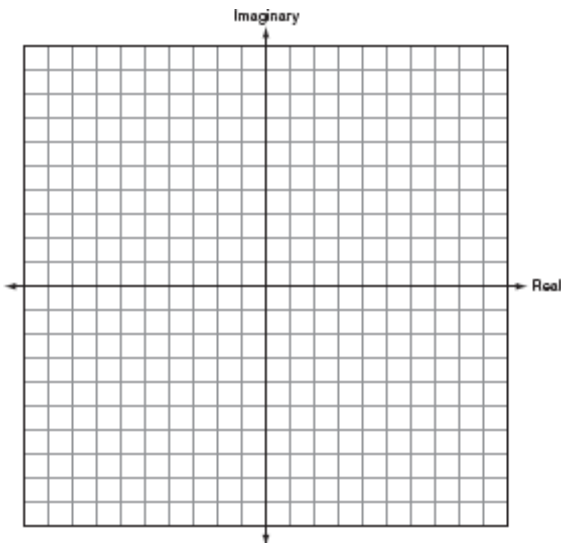

95. 060316b, P.I. A2.A.19

If  $\log a = 2$  and  $\log b = 3$ , what is the numerical value of  $\log \frac{\sqrt{a}}{b^3}$ ?

- [A] 25    [B] -8    [C] -25    [D] 8

96. 080224b, P.I. A.A.9

The Franklins inherited \$3,500, which they want to invest for their child's future college expenses. If they invest it at 8.25% with interest compounded monthly, determine the value of the account, in dollars, after 5 years.

Use the formula  $A = P\left(1 + \frac{r}{n}\right)^{nt}$ , where  $A =$  value of the investment after  $t$  years,  $P =$  principal invested,  $r =$  annual interest rate, and  $n =$  number of times compounded per year.

97. 060321b, P.I. A.A.41

Vanessa throws a tennis ball in the air. The function  $h(t) = -16t^2 + 45t + 7$  represents the distance, in feet, that the ball is from the ground at any time  $t$ . At what time, to the nearest tenth of a second, is the ball at its maximum height?

98. 080531b, P.I. A2.A.4

The profit,  $P$ , for manufacturing a wireless device is given by the equation

$P = -10x^2 + 750x - 9,000$ , where  $x$  is the selling price, in dollars, for each wireless device. What range of selling prices allows the manufacturer to make a profit on this wireless device? [The use of the grid is optional.]

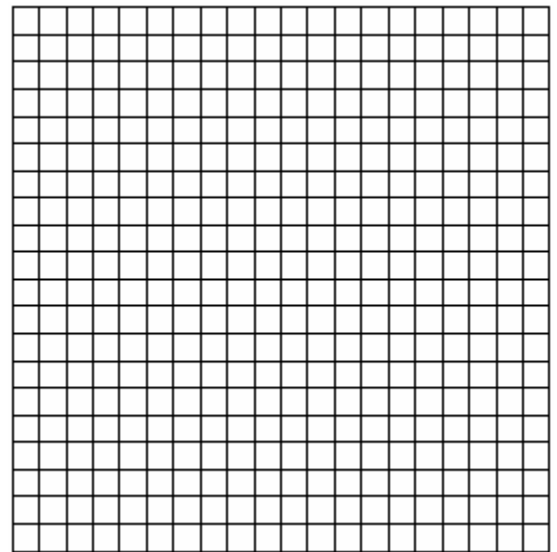

99. 080127b

The times of average monthly sunrise, as shown in the accompanying diagram, over the course of a 12-month interval can be modeled by the equation  $y = A \cos(Bx) + D$ .

Determine the values of  $A$ ,  $B$ , and  $D$ , and explain how you arrived at your values.

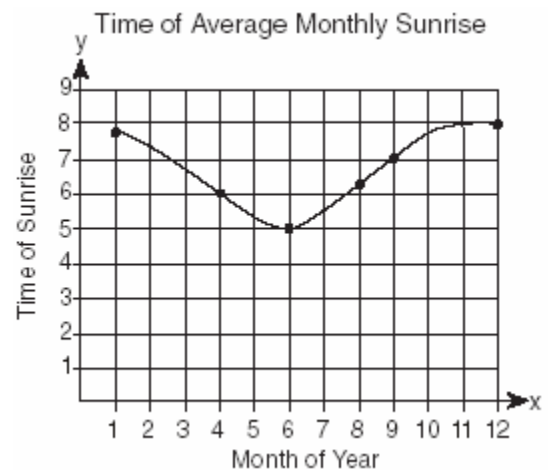

100. fall9917b, P.I. G.G.73  
The center and radius of the given circle  $(x - 3)^2 + (y + 8)^2 = 39$  are:
- [A]  $(-3, -8)$ ,  $r = \sqrt{39}$     [B]  $(-3, 8)$ ,  $r = \sqrt{39}$   
[C]  $(3, -8)$ ,  $r = \sqrt{39}$     [D]  $(3, -8)$ ,  $r = 39$

101. 010503b, P.I. A2.A.5  
If  $R$  varies inversely as  $S$ , when  $S$  is doubled,  $R$  is multiplied by
- [A]  $\frac{1}{4}$     [B] 4    [C]  $\frac{1}{2}$     [D] 2

102. 080701b, P.I. A2.A.41  
If  $f(x) = (x^{-x} - x^0 + 2^x)$ , then  $f(3)$  is equal to
- [A]  $8\frac{1}{27}$     [B]  $7\frac{1}{27}$   
[C]  $-22$     [D]  $-21$

103. 080433b  
The tide at a boat dock can be modeled by the equation  $y = -2\cos\left(\frac{\pi}{6}t\right) + 8$ , where  $t$  is the number of hours past noon and  $y$  is the height of the tide, in feet. For how many hours between  $t = 0$  and  $t = 12$  is the tide at least 7 feet? [The use of the grid is optional.]

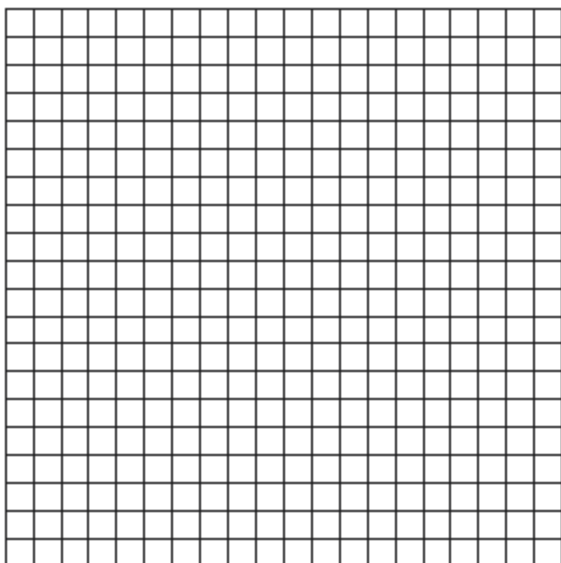

104. 010431b  
An acorn falls from the branch of a tree to the ground 25 feet below. The distance,  $S$ , the acorn is from the ground as it falls is represented by the equation  $S(t) = -16t^2 + 25$ , where  $t$  represents time, in seconds. Sketch a graph of this situation on the accompanying grid. Calculate, to the nearest hundredth of a second, the time the acorn will take to reach the ground.

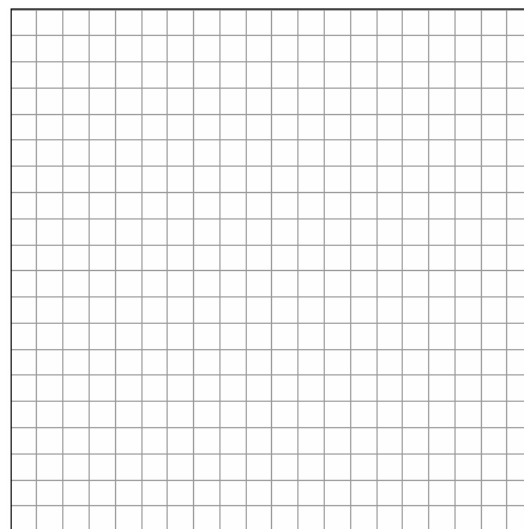

105. 010917b  
Which graph represents the equation  $9x^2 = 36 - 4y^2$ ?

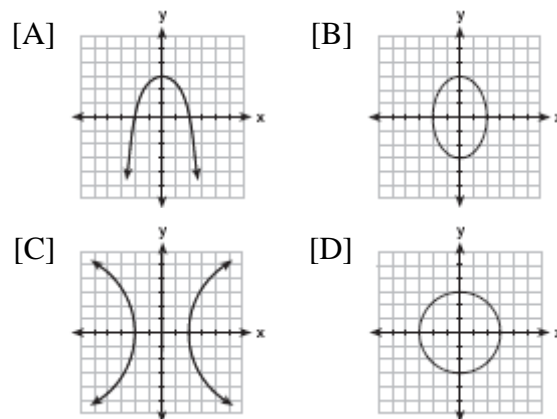

106. fall9930b, P.I. A2.A.27

In the equation  $y = 0.5(1.21)^x$ ,  $y$  represents the number of snowboarders in millions and  $x$  represents the number of years since 1988. Find the year in which the number of snowboarders will be 10 million for the first time. (Only an algebraic solution will be accepted.)

107. 080729b, P.I. A2.A.27

Drew's parents invested \$1,500 in an account such that the value of the investment doubles every seven years. The value of the investment,  $V$ , is determined by the equation  $V = 1500(2)^{\frac{t}{7}}$ , where  $t$  represents the number of years since the money was deposited. How many years, to the nearest tenth of a year, will it take the value of the investment to reach \$1,000,000?

108. 010410b

The accompanying diagram shows the elliptical orbit of a planet. The foci of the elliptical orbit are  $F_1$  and  $F_2$ .

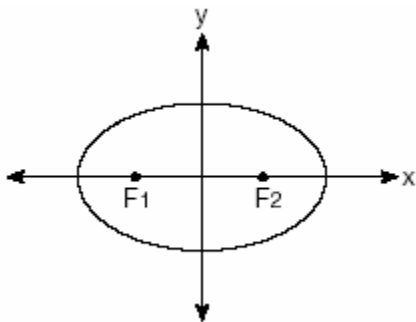

If  $a$ ,  $b$ , and  $c$  are all positive and  $a \neq b \neq c$ , which equation could represent the path of the planet?

- [A]  $ax^2 - by^2 = c^2$       [B]  $ax^2 + by^2 = c^2$   
 [C]  $x^2 + y^2 = c^2$       [D]  $y = ax^2 + c^2$

109. 060311b

The accompanying diagram represents the elliptical path of a ride at an amusement park.

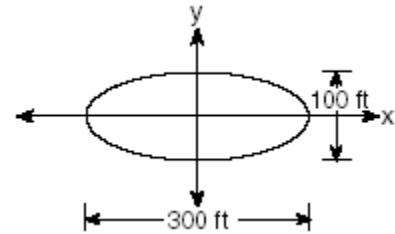

Which equation represents this path?

- [A]  $x^2 + y^2 = 300$       [B]  $\frac{x^2}{150^2} + \frac{y^2}{50^2} = 1$   
 [C]  $\frac{x^2}{150^2} - \frac{y^2}{50^2} = 1$   
 [D]  $y = x^2 + 100x + 300$

110. 060228b, P.I. A.A.11

A pelican flying in the air over water drops a crab from a height of 30 feet. The distance the crab is from the water as it falls can be represented by the function  $h(t) = -16t^2 + 30$ , where  $t$  is time, in seconds. To catch the crab as it falls, a gull flies along a path represented by the function  $g(t) = -8t + 15$ . Can the gull catch the crab before the crab hits the water? Justify your answer. [The use of the grid is optional.]

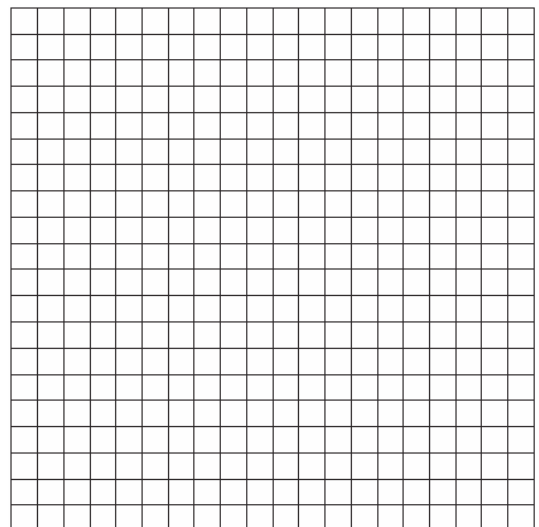

111. 080428b, P.I. A2.A.27  
An amount of  $P$  dollars is deposited in an account paying an annual interest rate  $r$  (as a decimal) compounded  $n$  times per year. After  $t$  years, the amount of money in the account, in dollars, is given by the equation

$$A = P\left(1 + \frac{r}{n}\right)^{nt}$$

Rachel deposited \$1,000 at 2.8% annual interest, compounded monthly. In how many years, to the *nearest tenth of a year*, will she have \$2,500 in the account? [The use of the grid is optional.]

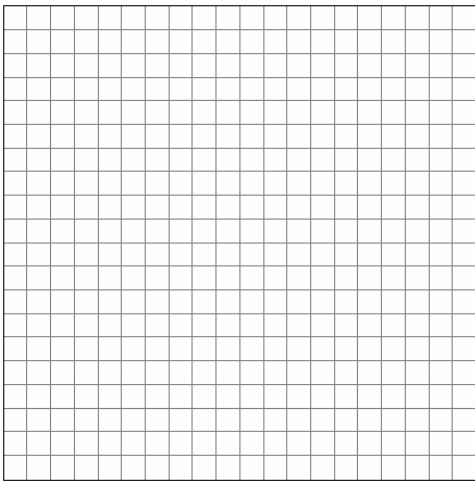

112. 060231b, P.I. A2.A.73  
A ship at sea heads directly toward a cliff on the shoreline. The accompanying diagram shows the top of the cliff,  $D$ , sighted from two locations,  $A$  and  $B$ , separated by distance  $S$ . If  $m\angle DAC = 30^\circ$ ,  $m\angle DBC = 45^\circ$ , and  $S = 30$  feet, what is the height of the cliff, to the *nearest foot*?

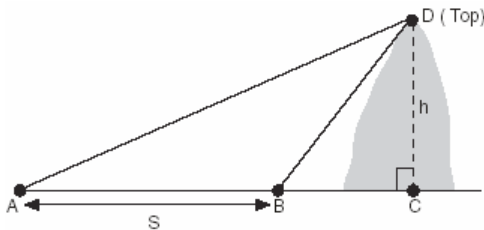

113. 060616b  
Which equation represents a hyperbola?

[A]  $y = 16x^2$                       [B]  $y^2 = 16 - x^2$

[C]  $y = 16 - x^2$                       [D]  $y = \frac{16}{x}$

114. 010704b  
What is the total number of points of intersection of the graphs of the equations  $xy = 12$  and  $y = -x^2 + 3$ ?

[A] 1            [B] 3            [C] 2            [D] 4

115. 060323b, P.I. A2.A.5  
When air is pumped into an automobile tire, the pressure is inversely proportional to the volume. If the pressure is 35 pounds when the volume is 120 cubic inches, what is the pressure, in pounds, when the volume is 140 cubic inches?

116. 060832b  
A radio wave has an amplitude of 3 and a wavelength (period) of  $\pi$  meters. On the accompanying grid, using the interval 0 to  $2\pi$ , draw a possible sine curve for this wave that passes through the origin.

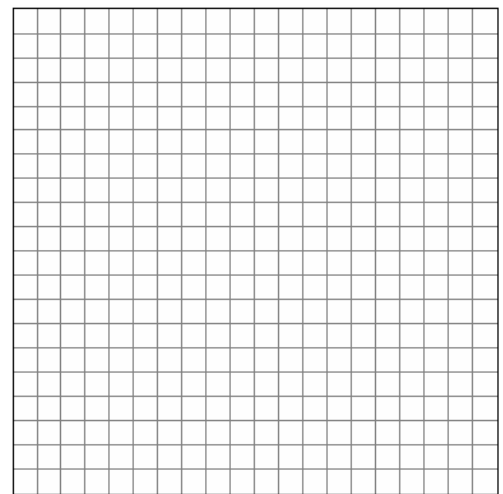

117. 060803b, P.I. A.A.9  
Kathy deposits \$25 into an investment account with an annual rate of 5%, compounded annually. The amount in her account can be determined by the formula  $A = P(1 + R)^t$ , where  $P$  is the amount deposited,  $R$  is the annual interest rate, and  $t$  is the number of years the money is invested. If she makes no other deposits or withdrawals, how much money will be in her account at the end of 15 years?

- [A] \$51.97                      [B] \$43.75  
[C] \$393.97                    [D] \$25.75

118. 060224b, P.I. A2.A.27  
Growth of a certain strain of bacteria is modeled by the equation  $G = A(2.7)^{0.584t}$ , where:  $G$  = final number of bacteria,  $A$  = initial number of bacteria,  $t$  = time (in hours). In approximately how many hours will 4 bacteria first increase to 2,500 bacteria? Round your answer to the *nearest hour*.

119. 080715b, P.I. G.G.61  
The coordinates of  $\triangle JRB$  are  $J(1,-2)$ ,  $R(-3,6)$ , and  $B(4,5)$ . What are the coordinates of the vertices of its image after the transformation  $T_{2,-1} \circ r_{y\text{-axis}}$ ?

- [A] (1,-3), (5,5), (-2,4)  
[B] (-1,-2), (3,6), (-4,5)  
[C] (3,-3), (-1,5), (6,4)  
[D] (3,1), (-1,-7), (6,-6)

120. 060508b, P.I. A2.A.5  
In a given rectangle, the length varies inversely as the width. If the length is doubled, the width will

- [A] be multiplied by 2  
[B] increase by 2  
[C] be divided by 2    [D] remain the same

121. 060226b, P.I. A.A.7  
Island Rent-a-Car charges a car rental fee of \$40 plus \$5 per hour or fraction of an hour. Wayne's Wheels charges a car rental fee of \$25 plus \$7.50 per hour or fraction of an hour. Under what conditions does it cost *less* to rent from Island Rent-a-Car? [The use of the accompanying grid is optional.]

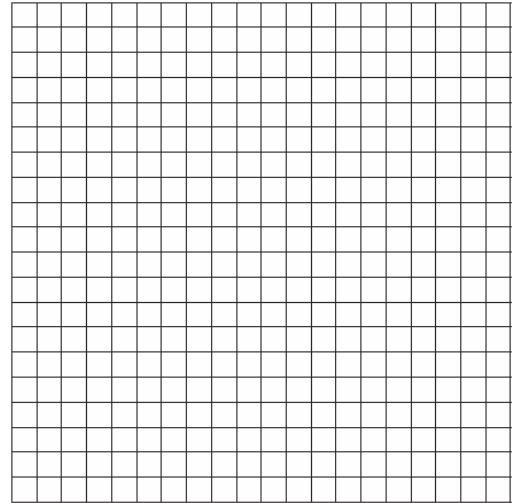

122. 080304b, P.I. A2.A.52  
The strength of a medication over time is represented by the equation  $y = 200(1.5)^{-x}$ , where  $x$  represents the number of hours since the medication was taken and  $y$  represents the number of micrograms per millimeter left in the blood. Which graph best represents this relationship?

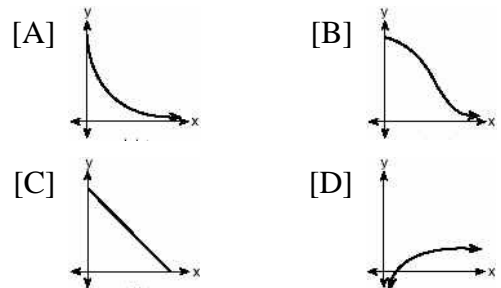

123. 010618b, P.I. G.G.61  
What are the coordinates of point  $A'$ , the image of point  $A(-4,1)$  after the composite transformation  $R_{90^\circ} \circ r_{y=x}$  where the origin is the center of rotation?

[A] (-1,-4)                      [B] (-4,-1)  
[C] (1,4)                         [D] (4,1)

124. 080611b  
What is the total number of points of intersection for the graphs of the equations  $y = x^2$  and  $y = -x^2$ ?

[A] 2            [B] 1            [C] 0            [D] 3

125. 060308b, P.I. A.M.1  
Two objects are  $2.4 \times 10^{20}$  centimeters apart. A message from one object travels to the other at a rate of  $1.2 \times 10^5$  centimeters per second. How many seconds does it take the message to travel from one object to the other?

[A]  $2.88 \times 10^{25}$                       [B]  $1.2 \times 10^{15}$   
[C]  $2.0 \times 10^4$                          [D]  $2.0 \times 10^{15}$

126. 080204b, P.I. A2.A.39  
What is the domain of  $f(x) = 2^x$ ?

[A] all real numbers            [B]  $x \geq 0$   
[C] all integers                 [D]  $x \leq 0$

127. 080501b, P.I. A.A.41  
What is the turning point, or vertex, of the parabola whose equation is  $y = 3x^2 + 6x - 1$ ?

[A] (-1,-4)                      [B] (1,8)  
[C] (-3,8)                         [D] (3,44)

128. 080721b, P.I. A2.A.46  
The graph of the function  $f(x) = a^x$  is shown on the accompanying set of axes. On the same set of axes, sketch the reflection of  $f(x)$  in the  $y$ -axis. State the coordinates of the point where the graphs intersect.

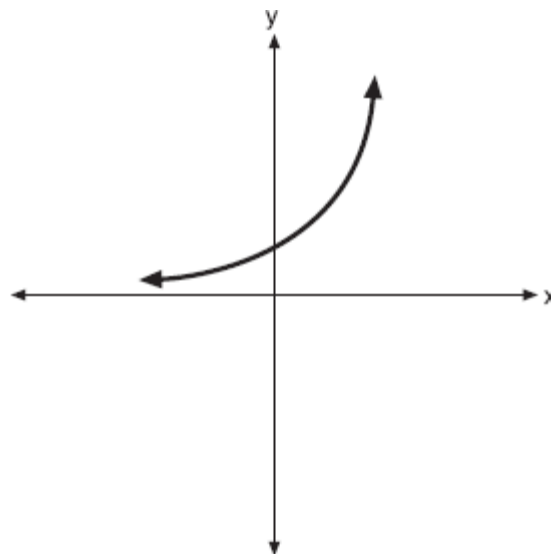

129. 060431b, P.I. A2.A.27  
An archaeologist can determine the approximate age of certain ancient specimens by measuring the amount of carbon-14, a radioactive substance, contained in the specimen. The formula used to determine the age of a specimen is  $A = A_0 2^{\frac{-t}{5760}}$ , where  $A$  is the amount of carbon-14 that a specimen contains,  $A_0$  is the original amount of carbon-14,  $t$  is time, in years, and 5760 is the half-life of carbon-14. A specimen that originally contained 120 milligrams of carbon-14 now contains 100 milligrams of this substance. What is the age of the specimen, to the nearest hundred years?

130. 060209b, P.I. A2.S.7  
What is the equation of a parabola that goes through points (0,1), (-1,6), and (2,3)?

[A]  $y = x^2 + 1$                       [B]  $y = x^2 - 3x + 1$   
[C]  $y = 2x^2 + 1$                       [D]  $y = 2x^2 - 3x + 1$

131. 010519b, P.I. A2.A.28

If  $\log_5 x = 2$ , what is the value of  $\sqrt{x}$ ?

- [A]  $2^{\frac{2}{5}}$  [B] 5 [C] 25 [D]  $\sqrt{5}$

132. 010509b, P.I. A2.A.4

Which graph represents the solution set of the inequality  $x^2 - 4x - 5 < 0$ ?

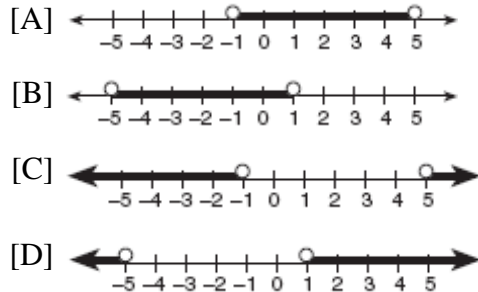

133. 010912b, P.I. G.G.74

A graphic designer is drawing a pattern of four concentric circles on the coordinate plane. The center of the circles is located at  $(-2,1)$ . The smallest circle has a radius of 1 unit. If the radius of each of the circles is one unit greater than the largest circle within it, what would be the equation of the fourth circle?

- [A]  $(x - 2)^2 + (y + 1)^2 = 16$   
 [B]  $(x + 2)^2 + (y - 1)^2 = 16$   
 [C]  $(x - 2)^2 + (y + 1)^2 = 4$   
 [D]  $(x + 2)^2 + (y - 1)^2 = 4$

134. 060506b, P.I. G.G.73

What are the coordinates of the center of the circle represented by the equation  $(x + 3)^2 + (y - 4)^2 = 25$ ?

- [A]  $(-3,-4)$  [B]  $(3,-4)$   
 [C]  $(-3,4)$  [D]  $(3,4)$

135. 080820b

The accompanying graph shows the relationship between kinetic energy,  $y$ , and velocity,  $x$ .

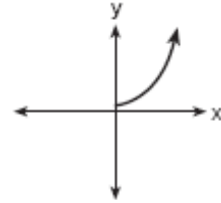

The reflection of this graph in the line  $y = x$  is

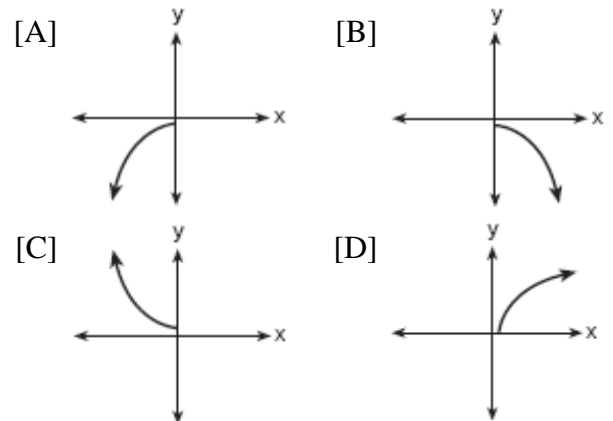

136. 060618b, P.I. A2.A.5

According to Boyle's Law, the pressure,  $p$ , of a compressed gas is inversely proportional to the volume,  $v$ . If a pressure of 20 pounds per square inch exists when the volume of the gas is 500 cubic inches, what is the pressure when the gas is compressed to 400 cubic inches?

- [A] 50 lb/in<sup>2</sup> [B] 25 lb/in<sup>2</sup>  
 [C] 16 lb/in<sup>2</sup> [D] 40 lb/in<sup>2</sup>



137. 060632b, P.I. A2.A.4

A small rocket is launched from a height of 72 feet. The height of the rocket in feet,  $h$ , is represented by the equation

$$h(t) = -16t^2 + 64t + 72, \text{ where } t = \text{time, in}$$

seconds. Graph this equation on the accompanying grid. Use your graph to determine the number of seconds that the rocket will remain at or above 100 feet from the ground. [Only a graphic solution can receive full credit.]

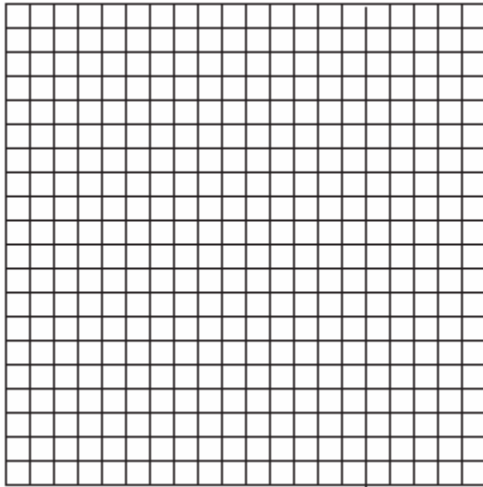

138. 080517b

An object orbiting a planet travels in a path represented by the equation

$$3(y + 1)^2 + 5(x + 4)^2 = 15. \text{ In which type of pattern does the object travel?}$$

- [A] hyperbola                      [B] parabola  
[C] circle                            [D] ellipse

139. 010729b, P.I. A2.A.25

Matt's rectangular patio measures 9 feet by 12 feet. He wants to increase the patio's dimensions so its area will be twice the area it is now. He plans to increase both the length and the width by the same amount,  $x$ . Find  $x$ , to the nearest hundredth of a foot.

140. 080312b

The accompanying graph shows the relationship between a person's weight and the distance that the person must sit from the center of a seesaw to make it balanced.

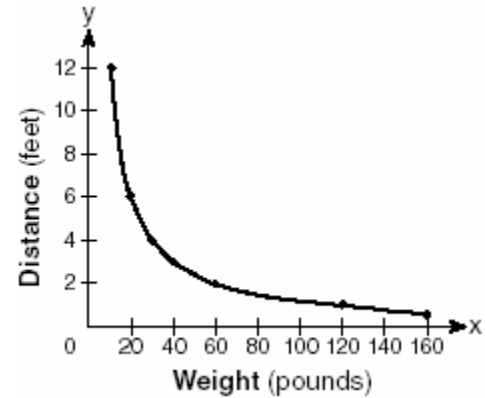

Which equation best represents this graph?

- [A]  $y = \frac{120}{x}$                       [B]  $y = 12x^2$   
[C]  $y = -120x$                 [D]  $y = 2 \log x$

141. 080609b

A designer who is planning to install an elliptical mirror is laying out the design on a coordinate grid. Which equation could represent the elliptical mirror?

- [A]  $x^2 + y^2 = 144$             [B]  $y = 4y^2 + 144$   
[C]  $x^2 + 4y^2 = 144$         [D]  $x^2 = 144 + 36y^2$

142. fall9915b, P.I. A.A.41

A model rocket is launched from ground level. Its height,  $h$  meters above the ground, is a function of time  $t$  seconds after launch and is given by the equation

$$h = -4.9t^2 + 68.6t. \text{ What would be the maximum height, to the nearest meter, attained by the model?}$$

- [A] 242    [B] 243    [C] 240    [D] 241

143. 010734b, P.I. A2.A.73  
Two forces of 40 pounds and 20 pounds, respectively, act simultaneously on an object. The angle between the two forces is  $40^\circ$ . Find the magnitude of the resultant, to the nearest tenth of a pound. Find the measure of the angle, to the nearest degree, between the resultant and the larger force.

144. 010930b, P.I. G.G.61  
Farmington, New York, has plans for a new triangular park. If plotted on a coordinate grid, the vertices would be  $A(3,3)$ ,  $B(5,-2)$ , and  $C(-3,-1)$ . However, a tract of land has become available that would enable the planners to increase the size of the park, which is based on the following transformation of the original triangular park,  $R_{270} \circ D_2$ . On the grid below, graph and label both the original park  $\triangle ABC$  and its image, the new park  $\triangle A''B''C''$ , following the transformation.

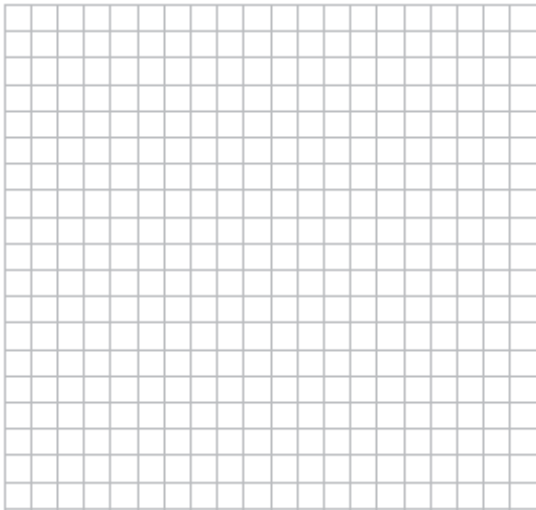

145. 060519b  
The graphs of the equations  $y = 2^x$  and  $y = -2x + a$  intersect in Quadrant I for which values of  $a$ ?

- [A]  $a > 1$                       [B]  $a \geq 1$   
[C]  $0 < a < 1$                 [D]  $a < 1$

146. 010717b, P.I. A2.A.19  
A black hole is a region in space where objects seem to disappear. A formula used in the study of black holes is the Schwarzschild formula,  $R = \frac{2GM}{c^2}$ . Based on the laws of logarithms,  $\log R$  can be represented by

- [A]  $\log 2G + \log M - \log 2c$   
[B]  $\log 2 + \log G + \log M - 2 \log c$   
[C]  $2 \log GM - 2 \log c$   
[D]  $2 \log G + \log M - \log 2c$

147. 080732b  
Two circles whose equations are  $(x - 3)^2 + (y - 5)^2 = 25$  and  $(x - 7)^2 + (y - 5)^2 = 9$  intersect in two points. What is the equation of the line passing through these two points? [The use of the accompanying grid is optional.]

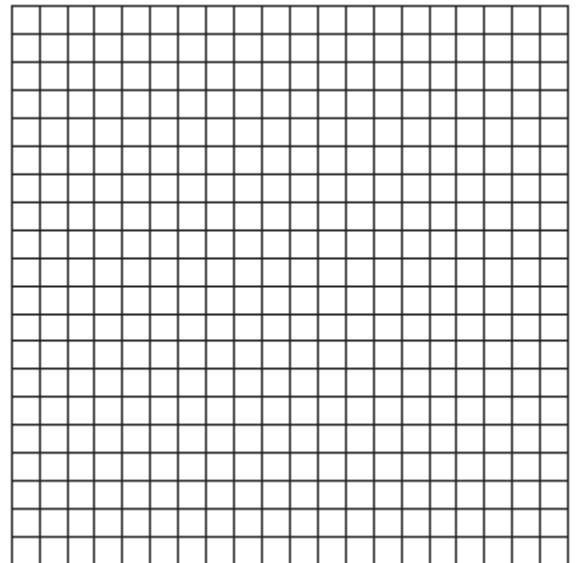

148. 060623b, P.I. A2.A.28  
Solve for  $x$ :  $\log_2(x + 1) = 3$

149. 010322b  
The height of an object,  $h(t)$ , is determined by the formula  $h(t) = -16t^2 + 256t$ , where  $t$  is time, in seconds. Will the object reach a maximum or a minimum? Explain or show your reasoning.

150. 010413b, P.I. A2.A.10  
The expression  $b^{-\frac{3}{2}}$ ,  $b > 0$ , is equivalent to

- [A]  $(\sqrt[3]{b})^2$                       [B]  $\frac{1}{(\sqrt[3]{b})^2}$   
[C]  $\frac{1}{(\sqrt{b})^3}$                       [D]  $-(\sqrt{b})^3$

151. 080532b, P.I. A2.A.70  
On the accompanying set of axes, graph the equations  $y = 4\cos x$  and  $y = 2$  in the domain  $-\pi \leq x \leq \pi$ . Express, in terms of  $\pi$ , the interval for which  $4\cos x \geq 2$ .

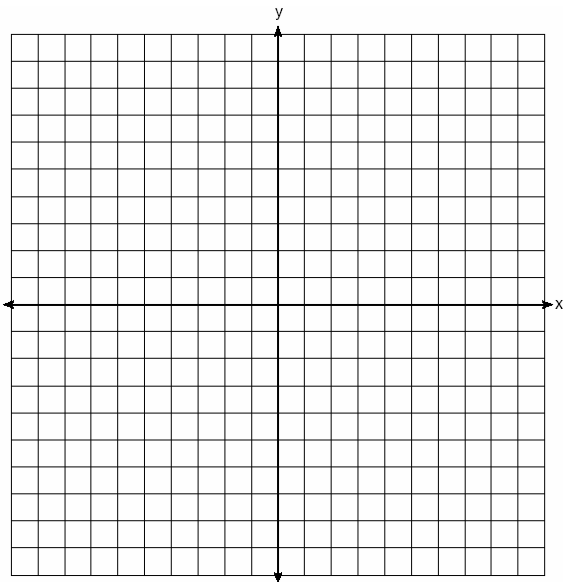

152. 010514b, P.I. G.G.71  
What is the equation of a circle with center  $(-3, 1)$  and radius 7?

- [A]  $(x + 3)^2 + (y - 1)^2 = 49$   
[B]  $(x + 3)^2 + (y - 1)^2 = 7$   
[C]  $(x - 3)^2 + (y + 1)^2 = 7$   
[D]  $(x - 3)^2 + (y + 1)^2 = 49$

153. 080116b, P.I. A2.A.61  
A wedge-shaped piece is cut from a circular pizza. The radius of the pizza is 6 inches. The rounded edge of the crust of the piece measures 4.2 inches. To the nearest tenth, the angle of the pointed end of the piece of pizza, in radians, is

- [A] 1.4    [B] 25.2    [C] 0.7    [D] 7.0

154. fall9913b  
The price of a certain stock has decreased over 5 years, as shown in the graph below. Which of the following equations best represents this graph?

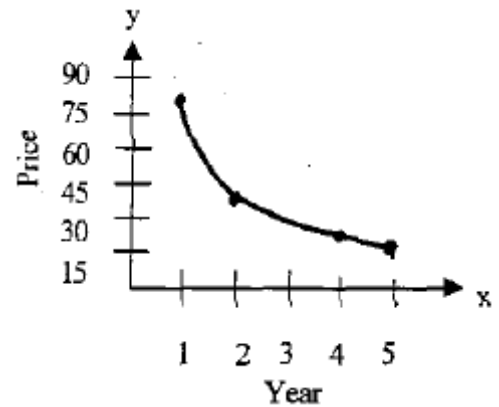

- [A]  $y = 60x^2$                       [B]  $y = -25x$   
[C]  $y = \frac{80}{x}$                       [D]  $y = 63\log x$

155. 060125b, P.I. A2.A.18  
The scientists in a laboratory company raise amebas to sell to schools for use in biology classes. They know that one ameba divides into two amebas every hour and that the formula  $t = \log_2 N$  can be used to determine how long in hours,  $t$ , it takes to produce a certain number of amebas,  $N$ . Determine, to the *nearest tenth of an hour*, how long it takes to produce 10,000 amebas if they start with one ameba.

156. 010716b, P.I. G.G.72  
Which equation represents the circle shown in the accompanying graph?

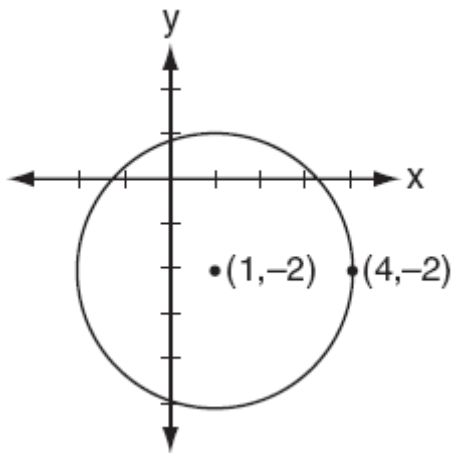

- [A]  $(x - 1)^2 - (y + 2)^2 = 9$   
[B]  $(x - 1)^2 + (y + 2)^2 = 9$   
[C]  $(x + 1)^2 + (y - 2)^2 = 9$   
[D]  $(x + 1)^2 - (y - 2)^2 = 9$

157. 060113b, P.I. A.A.1  
A store advertises that during its Labor Day sale \$15 will be deducted from every purchase over \$100. In addition, after the deduction is taken, the store offers an early-bird discount of 20% to any person who makes a purchase before 10 a.m. If Hakeem makes a purchase of  $x$  dollars,  $x > 100$ , at 8 a.m., what, in terms of  $x$ , is the cost of Hakeem's purchase?

- [A]  $0.85x - 20$       [B]  $0.20x - 15$   
[C]  $0.20x - 3$       [D]  $0.80x - 12$

158. 010827b, P.I. A2.A.73  
The measures of the angles between the resultant and two applied forces are  $65^\circ$  and  $42^\circ$ , and the magnitude of the resultant is 24 pounds. Find, to the *nearest pound*, the magnitude of the larger force.

159. 010232b, P.I. G.G.61  
a On the accompanying grid, graph the equation  $2y = 2x^2 - 4$  in the interval  $-3 \leq x \leq 3$  and label it  $a$ .  
b On the same grid, sketch the image of  $a$  under  $T_{5,-2} \circ r_{x\text{-axis}}$  and label it  $b$ .

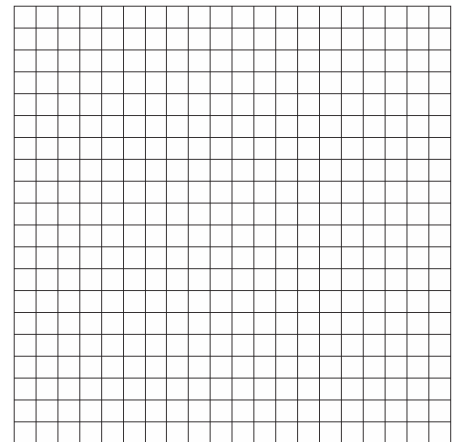

160. fall9919b  
If  $f(x) = 2 \sin 3x + C$ , then the maximum value of  $f(x)$  is:  
[A]  $C + 2$     [B]  $C + 3$     [C]  $C + 6$     [D]  $C$

161. 080628b

The accompanying diagram shows a triangular plot of land that is part of Fran's garden. She needs to change the dimensions of this part of the garden, but she wants the area to stay the same. She increases the length of side  $AC$  to 22.5 feet. If angle  $A$  remains the same, by how many feet should side  $AB$  be *decreased* to make the area of the new triangular plot of land the same as the current one?

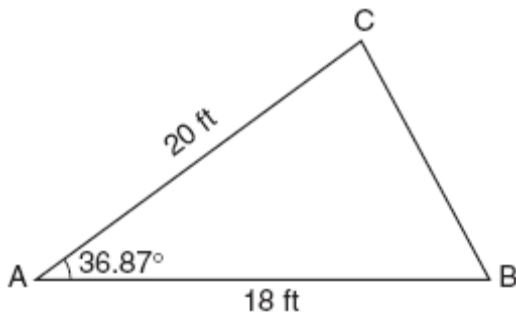

162. 060734b, P.I. A2.A.73

A jet is flying at a speed of 526 miles per hour. The pilot encounters turbulence due to a 50-mile-per-hour wind blowing at an angle of  $47^\circ$ , as shown in the accompanying diagram.

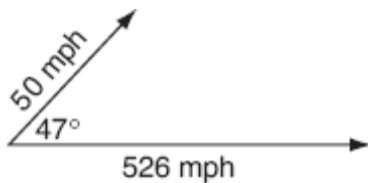

Find the resultant speed of the jet, to the *nearest tenth of a mile per hour*. Use this answer to find the measure of the angle between the resultant force and the wind vector, to the *nearest tenth of a degree*.

163. 010230b, P.I. A2.A.27

Depreciation (the decline in cash value) on a car can be determined by the formula  $V = C(1 - r)^t$ , where  $V$  is the value of the car after  $t$  years,  $C$  is the original cost, and  $r$  is the rate of depreciation. If a car's cost, when new, is \$15,000, the rate of depreciation is 30%, and the value of the car now is \$3,000, how old is the car to the *nearest tenth of a year*?

164. 080329b, P.I. A2.A.73

A ship at sea is 70 miles from one radio transmitter and 130 miles from another. The angle between the signals sent to the ship by the transmitters is  $117.4^\circ$ . Find the distance between the two transmitters, to the *nearest mile*.

165. 010208b, P.I. A2.A.19

Which expression is *not* equivalent to  $\log_b 36$ ?

- [A]  $2\log_b 6$                       [B]  $6\log_b 2$   
[C]  $\log_b 9 + \log_b 4$             [D]  $\log_b 72 - \log_b 2$

166. 010616b, P.I. A2.A.62

If  $\theta$  is an angle in standard position and  $P(-3,4)$  is a point on the terminal side of  $\theta$ , what is the value of  $\sin \theta$ ?

- [A]  $-\frac{4}{5}$     [B]  $-\frac{3}{5}$     [C]  $\frac{4}{5}$     [D]  $\frac{3}{5}$

167. 010307b, P.I. A2.A.61

Ileana buys a large circular pizza that is divided into eight equal slices. She measures along the outer edge of the crust from one piece and finds it to be  $5\frac{1}{2}$  inches. What is the diameter of the pizza to the *nearest inch*?

- [A] 7            [B] 4            [C] 8            [D] 14

168. 080807b, P.I. A2.A.10

If  $n > 0$ , the expression  $(\frac{1}{n})^{-\frac{2}{3}}$  is equal to

- [A]  $-n^{\frac{2}{3}}$                       [B]  $-n^{\frac{3}{2}}$   
[C]  $\sqrt[3]{n^2}$                       [D]  $\sqrt{n^3}$

169. 060205b

The path of a rocket is represented by the equation  $y = \sqrt{25 - x^2}$ . The path of a missile designed to intersect the path of the rocket is represented by the equation  $x = \frac{3}{2}\sqrt{y}$ . The value of  $x$  at the point of intersection is 3. What is the corresponding value of  $y$ ?

- [A] 4            [B] -2            [C] -4            [D] 2

170. fall9904b

The expression  $\log_2(x - 4)$  is undefined for all values of  $x$  such that

- [A]  $x \leq 0$                       [B]  $x > 1$   
[C]  $x \leq 4$                       [D]  $x > 0$

171. 060621b

Find the sum of  $-2 + 3i$  and  $-1 - 2i$ . Graph the resultant on the accompanying set of axes.

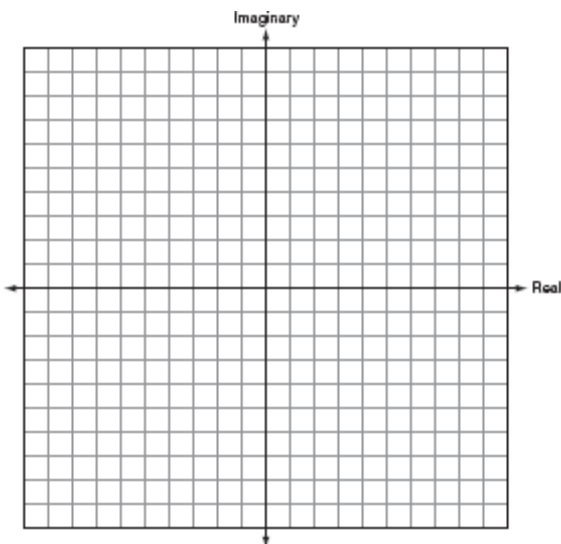

172. 060127b, P.I. A2.A.73

A wooden frame is to be constructed in the form of an isosceles trapezoid, with diagonals acting as braces to strengthen the frame. The sides of the frame each measure 5.30 feet, and the longer base measures 12.70 feet. If the angles between the sides and the longer base each measure  $68.4^\circ$ , find the length of one brace to the *nearest tenth of a foot*.

173. 080523b, P.I. A2.A.5

Boyle's Law states that the pressure of compressed gas is inversely proportional to its volume. The pressure of a certain sample of a gas is 16 kilopascals when its volume is 1,800 liters. What is the pressure, in kilopascals, when its volume is 900 liters?

174. 060703b

Which equation is best represented by the accompanying graph?

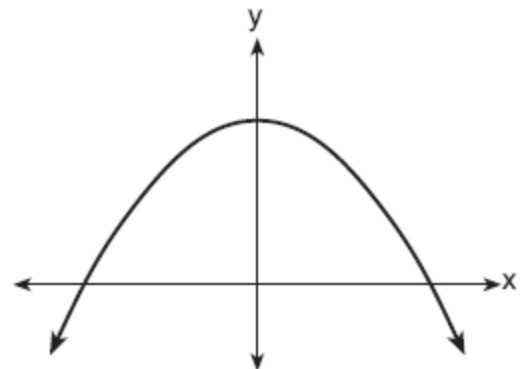

- [A]  $y = 6^x$                       [B]  $y = -x^2 + 1$   
[C]  $y = 6x^2$                       [D]  $y = 6x + 1$

175. 080321b, P.I. A.A.41

The height,  $h$ , in feet, a ball will reach when thrown in the air is a function of time,  $t$ , in seconds, given by the equation

$h(t) = -16t^2 + 30t + 6$ . Find, to the *nearest tenth*, the maximum height, in feet, the ball will reach.

176. 080809b, P.I. A2.A.19

The expression  $\frac{1}{2}\log m - 3\log n$  is equivalent to

[A]  $\log\sqrt{m} + \log n^3$       [B]  $\log\frac{1}{2}m - 3\log n$

[C]  $\log\frac{\sqrt{m}}{n^3}$       [D]  $\log\frac{m^2}{3\sqrt{n}}$

177. 060627b, P.I. A2.A.3

Solve the following system of equations algebraically:

$$9x^2 + y^2 = 9$$

$$3x - y = 3$$

178. 010231b, P.I. A2.A.4

When a baseball is hit by a batter, the height of the ball,  $h(t)$ , at time  $t$ ,  $t \geq 0$ , is determined by the equation  $h(t) = -16t^2 + 64t + 4$ . For which interval of time is the height of the ball greater than or equal to 52 feet?

179. 060814b, P.I. A2.A.27

If  $2^{4x+1} = 8^{x+a}$ , which expression is equivalent to  $x$ ?

[A]  $3a - 1$       [B]  $\frac{a-1}{3}$

[C]  $a - 1$       [D]  $\frac{a-1}{15}$

180. 060411b

Which equation models the data in the accompanying table?

Time in hours, $x$	0	1	2	3	4	5	6
Population, $y$	5	10	20	40	80	160	320

[A]  $y = 2x + 5$

[B]  $y = 2^x$

[C]  $y = 2x$

[D]  $y = 5(2^x)$

181. 010603b

Which graph shows that soil permeability varies inversely to runoff?

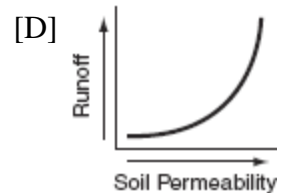
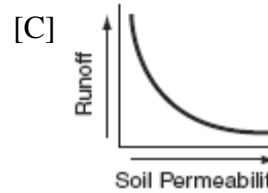
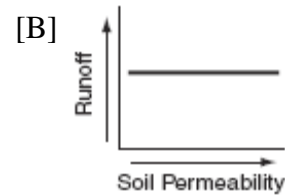
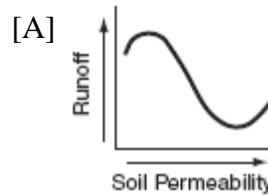

182. 010715b, P.I. A2.A.69

What is the amplitude of the function shown in the accompanying graph?

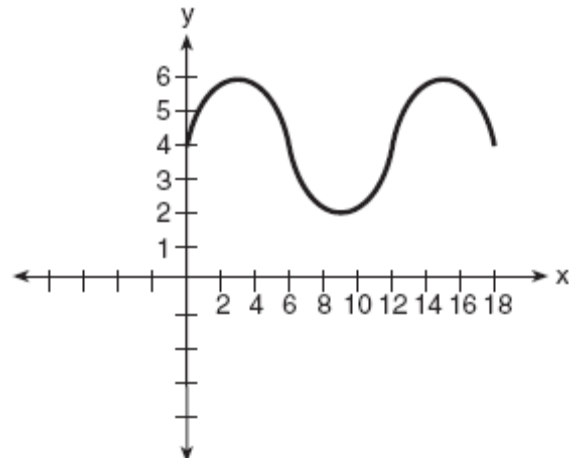

[A] 6

[B] 12

[C] 2

[D] 1.5

183. 060706b

What is one solution of the accompanying system of equations?

$$y = -x^2 + 5$$

$$y = -0.5x^2 + 3$$

[A] (0,3)

[B] (0,5)

[C] (-2,1)

[D] (3,5)

184. 080421b, P.I. A2.A.73

A ski lift begins at ground level 0.75 mile from the base of a mountain whose face has a  $50^\circ$  angle of elevation, as shown in the accompanying diagram. The ski lift ascends in a straight line at an angle of  $20^\circ$ . Find the length of the ski lift from the beginning of the ski lift to the top of the mountain, to the nearest hundredth of a mile.

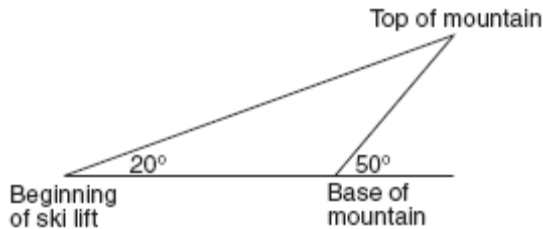

185. 060730b

A landscape architect is working on the plans for a new horse farm. He is laying out the exercise ring and racetrack on the accompanying graph. The location of the circular exercise ring, with point  $R$  as its center, has already been plotted.

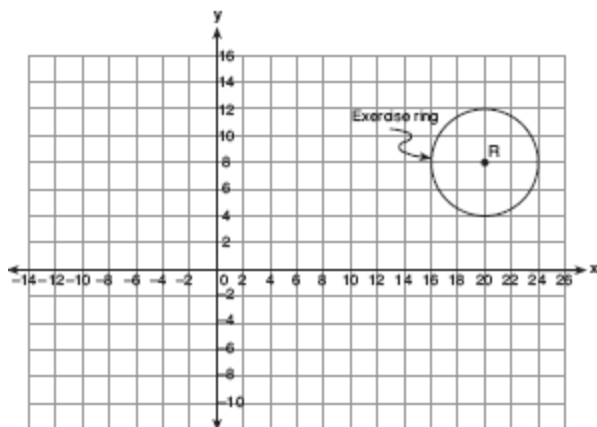

Write an equation that represents the outside edge of the exercise ring. The equation of the outside edge of the racetrack is  $\frac{x^2}{144} + \frac{y^2}{36} = 1$ .

Sketch the outside edge of the racetrack on the graph.

186. fall9931b, P.I. A2.A.70

A helicopter, starting at point  $A$  on Sunrise Highway, circles a 2-mile section of the highway in a counterclockwise direction. If the helicopter is traveling at a constant speed and it takes approximately 6.28 minutes to make one complete revolution to return to point  $A$ , sketch a possible graph of distance (dependent variable) from the helicopter to the highway, versus time (independent variable). If the helicopter is north of the highway, distance ( $d$ ) is positive; if the helicopter is south of the highway, distance ( $d$ ) is negative. (Disregard the height of the helicopter.) State the equation of this graph.

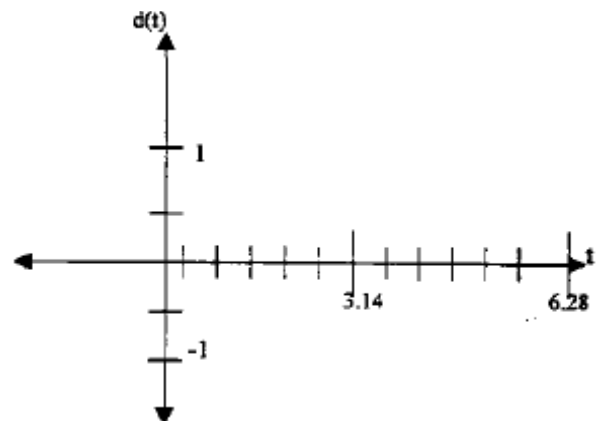
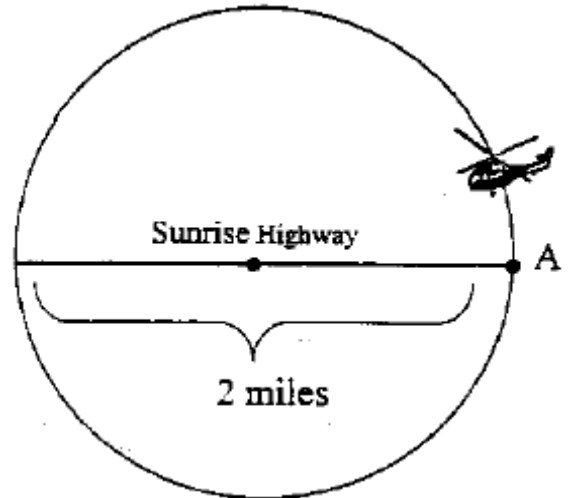



1. 060412b, P.I. A2.S.5

The amount of juice dispensed from a machine is normally distributed with a mean of 10.50 ounces and a standard deviation of 0.75 ounce. Which interval represents the amount of juice dispensed about 68.2% of the time?

- [A] 9.75-11.25      [B] 9.75-10.50  
[C] 10.50-11.25      [D] 9.00-12.00

2. 060130b, P.I. A2.A.44

Draw  $f(x) = 2x^2$  and  $f^{-1}(x)$  in the interval  $0 \leq x \leq 2$  on the accompanying set of axes. State the coordinates of the points of intersection.

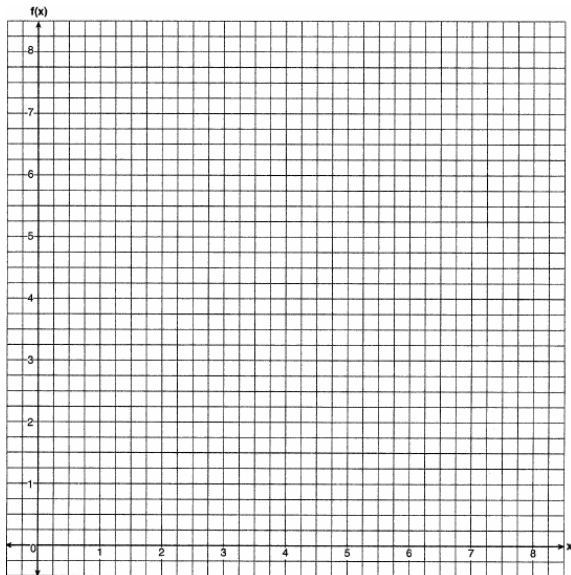

3. 080226b, P.I. A2.A.74

Two sides of a triangular-shaped pool measure 16 feet and 21 feet, and the included angle measures  $58^\circ$ . What is the area, to the nearest tenth of a square foot, of a nylon cover that would exactly cover the surface of the pool?

4. 080514b, P.I. A2.A.69

A certain radio wave travels in a path represented by the equation  $y = 5 \sin 2x$ . What is the period of this wave?

- [A] 5      [B] 2      [C]  $\pi$       [D]  $2\pi$

5. 010725b, P.I. A2.A.61

As shown in the accompanying diagram, a dial in the shape of a semicircle has a radius of 4 centimeters. Find the measure of  $\theta$ , in radians, when the pointer rotates to form an arc whose length is 1.38 centimeters.

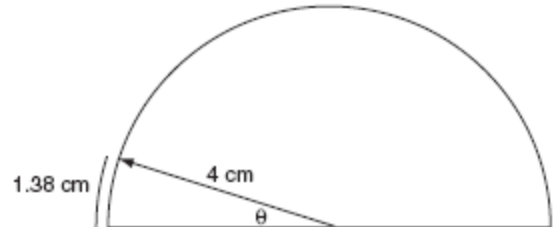

6. 010615b

What is the radian measure of the angle formed by the hands of a clock at 2:00 p.m.?

- [A]  $\frac{\pi}{4}$       [B]  $\frac{\pi}{2}$       [C]  $\frac{\pi}{6}$       [D]  $\frac{\pi}{3}$

7. 060403b, P.I. A2.A.69

What is the amplitude of the function

$$y = \frac{2}{3} \sin 4x ?$$

- [A]  $\frac{2}{3}$       [B]  $3\pi$       [C] 4      [D]  $\frac{\pi}{2}$

8. 080125b, P.I. A2.A.23

Working by herself, Mary requires 16 minutes more than Antoine to solve a mathematics problem. Working together, Mary and Antoine can solve the problem in 6 minutes. If this situation is represented by the equation  $\frac{6}{t} + \frac{6}{t+16} = 1$ , where  $t$  represents the number of minutes Antoine works alone to solve the problem, how many minutes will it take Antoine to solve the problem if he works by himself?

9. 060121b

Gregory wants to build a garden in the shape of an isosceles triangle with one of the congruent sides equal to 12 yards. If the area of his garden will be 55 square yards, find, to the nearest tenth of a degree, the three angles of the triangle.

10. 080816b, P.I. A2.N.9

The expression  $\frac{\sqrt{-50}}{\sqrt{2}}$  is equivalent to

- [A] 5      [B] -5      [C]  $5i$       [D]  $-5i$

11. 060534b, P.I. G.G.53

An architect is designing a park with an entrance represented by point  $C$  and a circular garden with center  $O$ , as shown in the accompanying diagram. The architect plans to connect three points on the circumference of the garden,  $A$ ,  $B$ , and  $D$ , to the park entrance,  $C$ , with walkways so that walkways  $\overline{CA}$  and  $\overline{CB}$  are tangent to the garden, walkway  $\overline{DOEC}$  is a path through the center of the garden,  $m\widehat{ADB} : m\widehat{AEB} = 3 : 2$ ,  $BC = 60$  meters, and  $EC = 43.6$  meters. Find the measure of the angle between walkways  $\overline{CA}$  and  $\overline{CB}$ . Find the diameter of the circular garden, to the nearest meter.

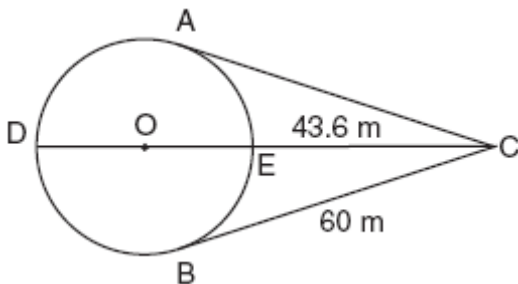

12. 080223b

An art student wants to make a string collage by connecting six equally spaced points on the circumference of a circle to its center with string. What would be the radian measure of the angle between two adjacent pieces of string, in simplest form?

13. 060716b

Cerise waters her lawn with a sprinkler that sprays water in a circular pattern at a distance of 15 feet from the sprinkler. The sprinkler head rotates through an angle of  $300^\circ$ , as shown by the shaded area in the accompanying diagram.

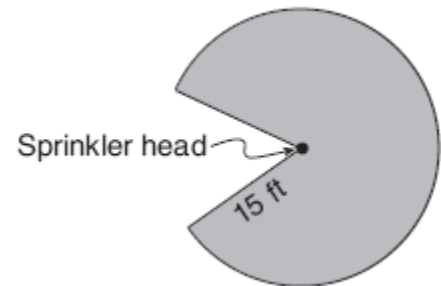

What is the area of the lawn, to the nearest square foot, that receives water from this sprinkler?

- [A] 94      [B] 707      [C] 79      [D] 589

14. 080333b, P.I. G.G.53

Given circle  $O$  with diameter  $\overline{GOAL}$ ; secants  $\overline{HUG}$  and  $\overline{HTAM}$  intersect at point  $H$ ;  $m\widehat{GM} : m\widehat{ML} : m\widehat{LT} = 7 : 3 : 2$ ; and chord  $\overline{GU} \cong$  chord  $\overline{UT}$ . Find the ratio of  $m\angle UGL$  to  $m\angle H$ .

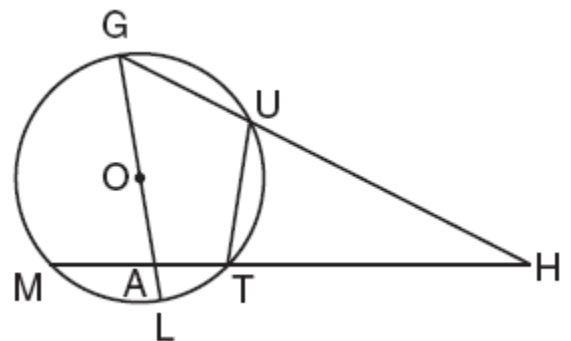

15. 080414b, P.I. A2.A.75

How many distinct triangles can be formed if  $m\angle A = 30$ , side  $b = 12$ , and side  $a = 8$ ?

- [A] 0      [B] 1      [C] 3      [D] 2

16. 060825b

The accompanying diagram shows the peak of a roof that is in the shape of an isosceles triangle. A base angle of the triangle is  $50^\circ$  and each side of the roof is 20.4 feet. Determine, to the nearest tenth of a square foot, the area of this triangular region.

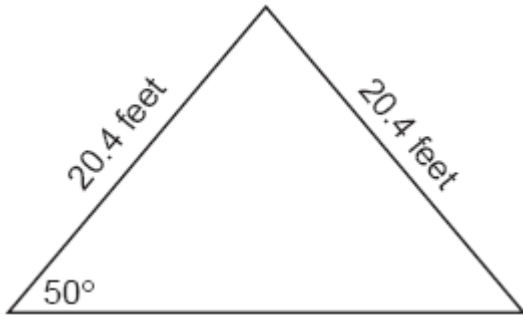

17. 080803b, P.I. G.G.53

The NUK Energy Company is designing a new logo, as shown in the accompanying diagram, with  $m\widehat{NK} = 130$  and  $m\widehat{NK} = m\widehat{NU}$ .

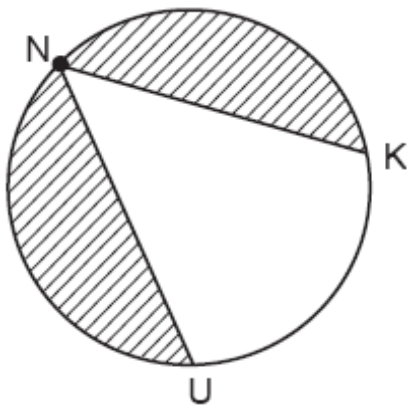

What is the measure of  $\angle KNU$ ?

- [A]  $65^\circ$  [B]  $100^\circ$  [C]  $80^\circ$  [D]  $50^\circ$

18. 080519b, P.I. A2.A.75

What is the total number of distinct triangles that can be constructed if  $AC = 13$ ,  $BC = 8$ , and  $m\angle A = 36^\circ$ ?

- [A] 1 [B] 2 [C] 0 [D] 3

19. 080409b, P.I. A2.A.76

If  $\sin A = \frac{4}{5}$ ,  $\tan B = \frac{5}{12}$ , and angles  $A$  and  $B$  are in Quadrant I, what is the value of  $\sin(A + B)$ ?

- [A]  $\frac{63}{65}$  [B]  $\frac{33}{65}$  [C]  $-\frac{33}{65}$  [D]  $-\frac{63}{65}$

20. 010808b

The accompanying diagram shows a resultant force vector,  $R$ .

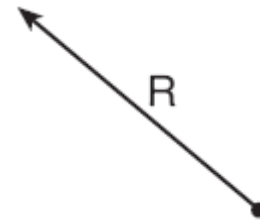

Which diagram best represents the pair of component force vectors,  $A$  and  $B$ , that combined to produce the resultant force vector  $R$ ?

[A]

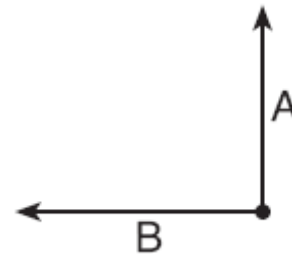

[B]

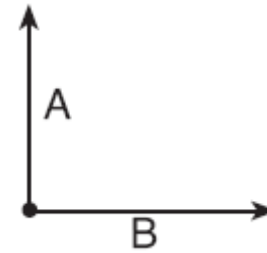

[C]



[D]

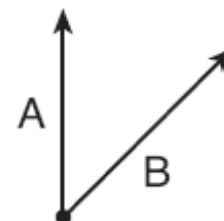

21. 010328b, P.I. A2.S.7

In a mathematics class of ten students, the teacher wanted to determine how a homework grade influenced a student's performance on the subsequent test. The homework grade and subsequent test grade for each student are given in the accompanying table.

Homework Grade ( $x$ )	Test Grade ( $y$ )
94	98
95	94
92	95
87	89
82	85
80	78
75	73
65	67
50	45
20	40

a Give the equation of the linear regression line for this set of data.

b A new student comes to the class and earns a homework grade of 78. Based on the equation in part *a*, what grade would the teacher predict the student would receive on the subsequent test, to the *nearest integer*?

22. 060124b, P.I. A.A.18

A rectangular prism has a length of  $\frac{2x^2 + 2x - 24}{4x^2 + x}$ , a width of  $\frac{x^2 + x - 6}{x + 4}$ , and a

height of  $\frac{8x^2 + 2x}{x^2 - 9}$ . For all values of  $x$  for which it is defined, express, in terms of  $x$ , the volume of the prism in simplest form.

23. 010911b, P.I. A2.A.58

What is a value of  $\text{Arc sin}\left(-\frac{\sqrt{2}}{2}\right)$ ?

- [A]  $-\frac{\pi}{4}$  [B]  $\frac{\pi}{2}$  [C]  $-\frac{\pi}{2}$  [D]  $\frac{\pi}{4}$

24. 010512b, P.I. A2.A.77

If  $A$  is a positive acute angle and  $\sin A = \frac{\sqrt{5}}{3}$ , what is  $\cos 2A$ ?

- [A]  $-\frac{1}{3}$  [B]  $\frac{1}{9}$  [C]  $\frac{1}{3}$  [D]  $-\frac{1}{9}$

25. 010225b, P.I. A2.A.74

The accompanying diagram shows the floor plan for a kitchen. The owners plan to carpet all of the kitchen except the "work space," which is represented by scalene triangle  $ABC$ . Find the area of this work space to the *nearest tenth of a square foot*.

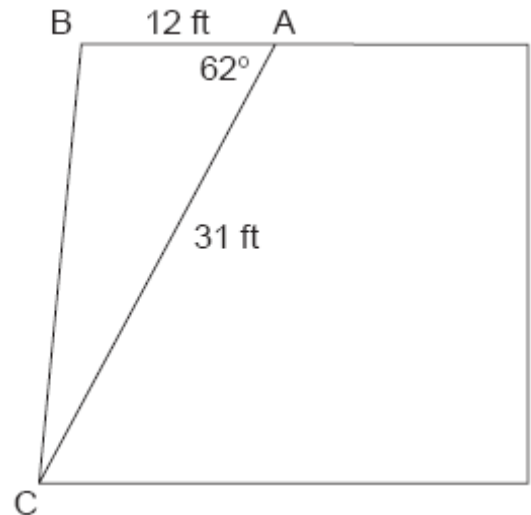

26. 080511b

Two straight roads intersect at an angle whose measure is  $125^\circ$ . Which expression is equivalent to the cosine of this angle?

- [A]  $-\cos 35^\circ$  [B]  $-\cos 55^\circ$   
[C]  $\cos 55^\circ$  [D]  $\cos 35^\circ$

27. 080719b, P.I. G.G.53

In the accompanying diagram,  $\overline{PA}$  is tangent to circle  $O$  at  $A$ ,  $\overline{PBC}$  is a secant,  $PB = 4$ , and  $BC = 8$ .

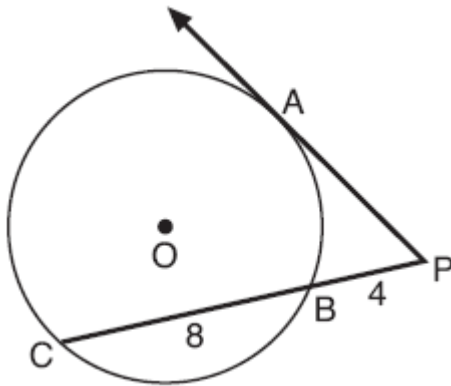

What is the length of  $\overline{PA}$ ?

- [A]  $4\sqrt{3}$  [B]  $4\sqrt{2}$  [C]  $4\sqrt{6}$  [D] 4

28. 060728b, P.I. A2.A.73

In the accompanying diagram of a streetlight, the light is attached to a pole at  $R$  and supported by a brace,  $\overline{PQ}$ ,  $RQ = 10$  feet,  $RP = 6$  feet,  $\angle PRQ$  is an obtuse angle, and  $m\angle PQR = 30$ . Find the length of the brace,  $\overline{PQ}$ , to the nearest foot.

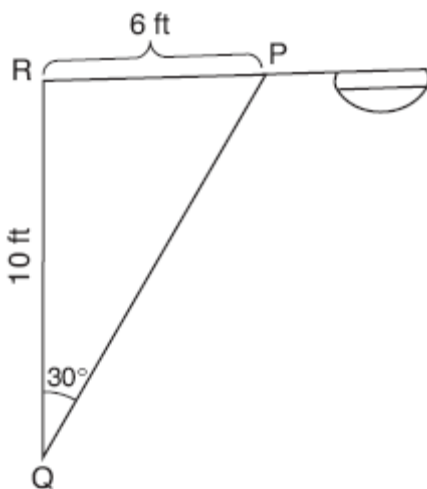

29. 060312b, P.I. A2.A.76

If  $A$  and  $B$  are positive acute angles,

$\sin A = \frac{5}{13}$ , and  $\cos B = \frac{4}{5}$ , what is the value of  $\sin(A + B)$ ?

- [A]  $\frac{33}{65}$  [B]  $\frac{56}{65}$  [C]  $\frac{63}{65}$  [D]  $-\frac{16}{65}$

30. 010309b, P.I. A2.A.75

In  $\triangle ABC$ , if  $AC = 12$ ,  $BC = 11$ , and  $m\angle A = 30$ , angle  $C$  could be

- [A] a right angle, only  
[B] an acute angle, only  
[C] either an obtuse angle or an acute angle  
[D] an obtuse angle, only

31. 010205b, P.I. A2.A.56

If  $\theta$  is an angle in standard position and its terminal side passes through the point

$(\frac{1}{2}, \frac{\sqrt{3}}{2})$  on a unit circle, a possible value of  $\theta$  is

- [A]  $120^\circ$  [B]  $150^\circ$  [C]  $60^\circ$  [D]  $30^\circ$

32. 060132b, P.I. G.G.51

Point  $P$  lies outside circle  $O$ , which has a diameter of  $\overline{AOC}$ . The angle formed by tangent  $\overline{PA}$  and secant  $\overline{PBC}$  measures  $30^\circ$ . Sketch the conditions given above and find the number of degrees in the measure of minor arc  $CB$ .

33. fall9932b, P.I. A2.A.61

If an arc of  $60^\circ$  on circle  $A$  has the same length as an arc of  $45^\circ$  on circle  $B$ , what is the ratio of the area of circle  $B$  to the area of circle  $A$ ?

34. 080828b, P.I. A2.A.73  
During a training exercise in the Mojave Desert, two military vehicles left the base camp at the same time, one traveling at an average speed of 25 miles per hour and the other at an average speed of 50 miles per hour. Each vehicle traveled along a level, straight route. If the exercise requires the two vehicles to be 65 miles apart after traveling for 1 hour, what must the angle between the two routes be, to the *nearest degree*?

35. 010910b, P.I. A2.A.61  
A central angle of a circular garden measures 2.5 radians and intercepts an arc of 20 feet. What is the radius of the garden?

[A] 100 ft                      [B] 50 ft  
[C] 8 ft                         [D] 125 ft

36. 080518b, P.I. G.G.50  
Kimi wants to determine the radius of a circular pool without getting wet. She is located at point  $K$ , which is 4 feet from the pool and 12 feet from the point of tangency, as shown in the accompanying diagram.

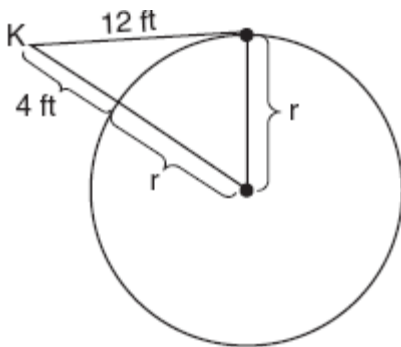

What is the radius of the pool?

[A] 16 ft                      [B]  $4\sqrt{10}$  ft  
[C] 20 ft                     [D] 32 ft

37. 060609b, P.I. A2.A.58  
If  $\tan \theta = 2.7$  and  $\csc \theta < 0$ , in which quadrant does  $\theta$  lie?

[A] I            [B] IV            [C] III            [D] II

38. 010425b, P.I. A2.A.69  
The brightness of the star MIRA over time is given by the equation  $y = 2 \sin \frac{\pi}{4}x + 6$ , where  $x$  represents time and  $y$  represents brightness. What is the period of this function, in radian measure?

39. 010609b, P.I. A2.A.77  
If  $\theta$  is a positive acute angle and  $\sin 2\theta = \frac{\sqrt{3}}{2}$ , then  $(\cos \theta + \sin \theta)^2$  equals

[A]  $60^\circ$     [B]  $1 + \frac{\sqrt{3}}{2}$     [C]  $30^\circ$     [D] 1

40. 080317b, P.I. A2.S.5  
The amount of ketchup dispensed from a machine at Hamburger Palace is normally distributed with a mean of 0.9 ounce and a standard deviation of 0.1 ounce. If the machine is used 500 times, approximately how many times will it be expected to dispense 1 or more ounces of ketchup?

[A] 100    [B] 5    [C] 80    [D] 16

41. 080826b, P.I. A2.A.44  
On the accompanying set of axes, graph the function  $f(x) = 2x + 4$  and its inverse,  $f^{-1}(x)$ .

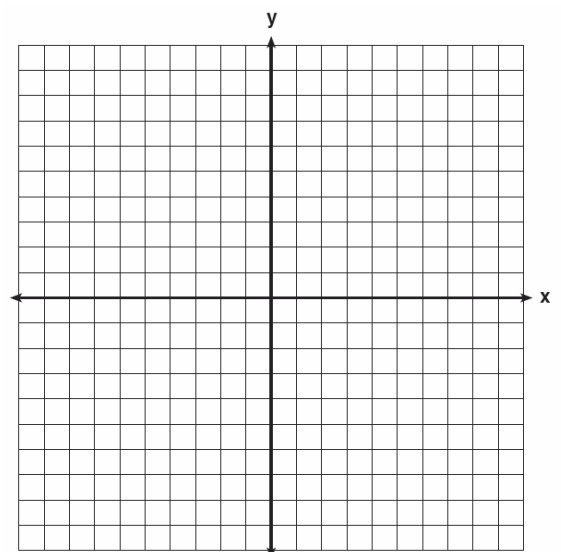

42. 010816b, P.I. A2.S.8

In the physics lab, Thelma determined the kinetic energy,  $KE$ , of an object at various velocities,  $V$ , and found the linear correlation coefficient between  $KE$  and  $V$  to be  $+0.8$ .

Which graph shows this relationship?

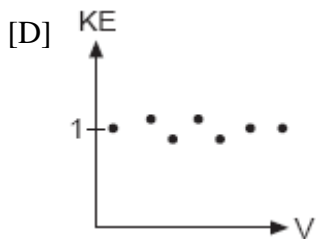
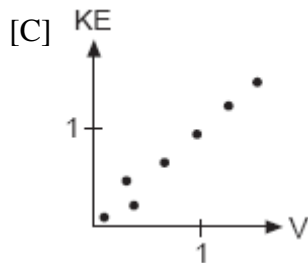
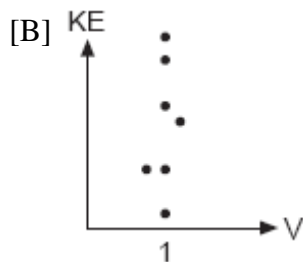
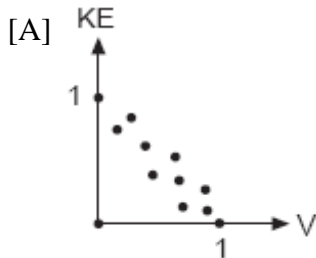

43. 080527b, P.I. A2.A.73

The accompanying diagram shows the plans for a cell-phone tower that is to be built near a busy highway. Find the height of the tower, to the nearest foot.



44. 080408b, P.I. G.G.53

The accompanying diagram shows a child's spin toy that is constructed from two chords intersecting in a circle. The curved edge of the larger shaded section is one-quarter of the circumference of the circle, and the curved edge of the smaller shaded section is one-fifth of the circumference of the circle.

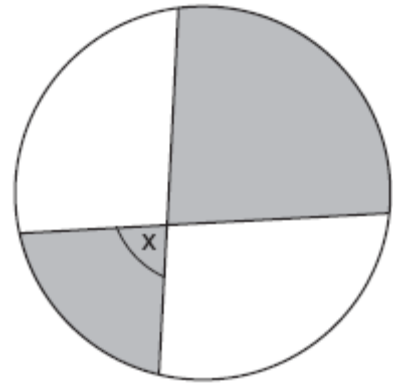

What is the measure of angle  $x$ ?

- [A]  $72^\circ$  [B]  $108^\circ$  [C]  $81^\circ$  [D]  $40^\circ$

45. 010606b, P.I. A2.A.69

A sound wave is modeled by the curve  $y = 3\sin 4x$ . What is the period of this curve?

- [A] 3 [B] 4 [C]  $\frac{\pi}{2}$  [D]  $\pi$

46. 010721b, P.I. G.G.53

In the accompanying diagram of circle  $O$ , diameter  $\overline{AOB}$  is extended through  $B$  to external point  $P$ , tangent  $\overline{PC}$  is drawn to point  $C$  on the circle, and  $m\widehat{AC} : m\widehat{BC} = 7 : 2$ . Find  $m\angle CPA$ .

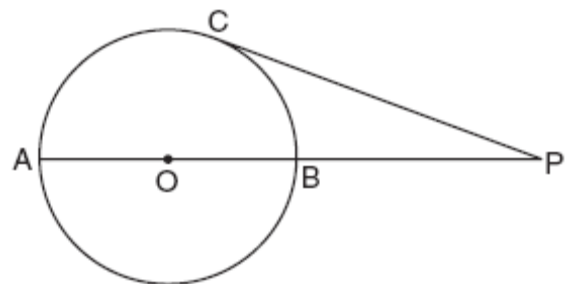

(Not drawn to scale)



47. 080132b, P.I. A2.A.27  
The amount  $A$ , in milligrams, of a 10-milligram dose of a drug remaining in the body after  $t$  hours is given by the formula  $A = 10(0.8)^t$ . Find, to the *nearest tenth of an hour*, how long it takes for half of the drug dose to be left in the body.

48. 010213b, P.I. G.G.50  
The accompanying diagram represents circular pond  $O$  with docks located at points  $A$  and  $B$ . From a cabin located at  $C$ , two sightings are taken that determine an angle of  $30^\circ$  for tangents  $\overline{CA}$  and  $\overline{CB}$ .

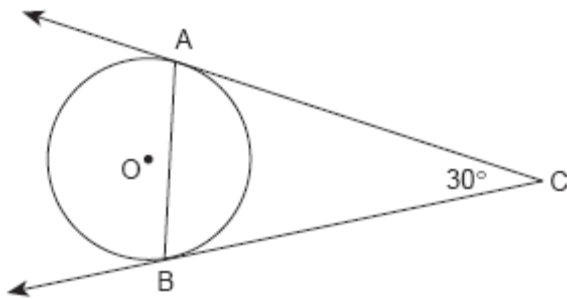

What is  $m\angle CAB$ ?

- [A] 75    [B] 60    [C] 30    [D] 150
49. 010227b, P.I. A2.A.73  
Two straight roads, Elm Street and Pine Street, intersect creating a  $40^\circ$  angle, as shown in the accompanying diagram. John's house ( $J$ ) is on Elm Street and is 3.2 miles from the point of intersection. Mary's house ( $M$ ) is on Pine Street and is 5.6 miles from the intersection. Find, to the *nearest tenth of a mile*, the direct distance between the two houses.

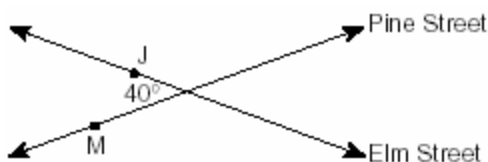

50. 080717b, P.I. A2.A.72  
The accompanying graph represents a portion of a sound wave.

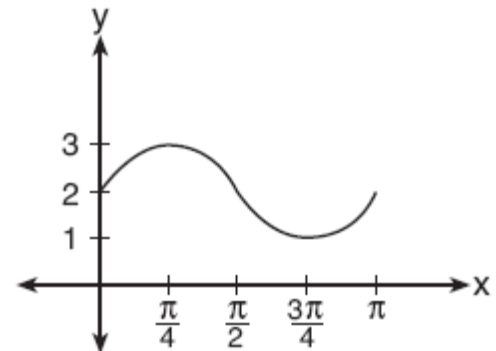

Which equation best represents this graph?

- [A]  $y = \sin 2x + 2$     [B]  $y = 2 \sin \frac{1}{2}x$   
[C]  $y = \sin 2x$     [D]  $y = \sin \frac{1}{2}x + 2$

51. 060433b, P.I. G.G.53  
The accompanying diagram shows a circular machine part that has rods  $\overline{PT}$  and  $\overline{PAR}$  attached at points  $T$ ,  $A$ , and  $R$ , which are located on the circle;  
 $m\widehat{TA} : m\widehat{AR} : m\widehat{RT} = 1 : 3 : 5$ ;  $RA = 12$  centimeters; and  $PA = 5$  centimeters.

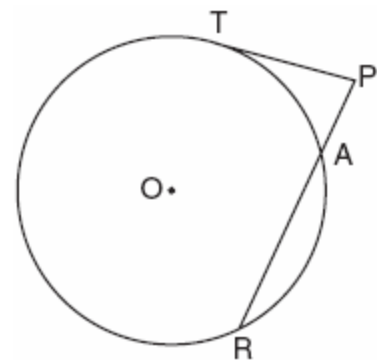

Find the measure of  $\angle P$ , in degrees, and find the length of rod  $\overline{PT}$ , to the *nearest tenth of a centimeter*.



52. 010815b, P.I. A.S.3  
Which method of collecting data would most likely result in an unbiased random sample?
- [A] selecting every third teenager leaving a movie theater to answer a survey about entertainment
- [B] selecting students by the last digit of their school ID number to participate in a survey about cafeteria food
- [C] surveying honor students taking Mathematics B to determine the average amount of time students in a school spend doing homework each night
- [D] placing a survey in a local newspaper to determine how people voted in the 2004 presidential election

53. 010908b, P.I. G.G.53  
The accompanying diagram shows two intersecting paths within a circular garden.

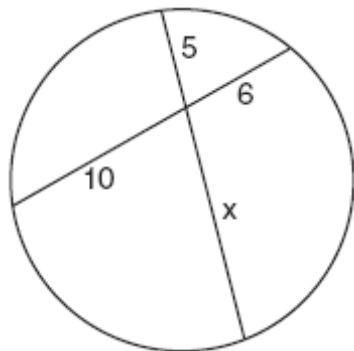

What is the length of the portion of the path marked  $x$ ?

- [A] 3      [B]  $8\frac{1}{3}$       [C] 12      [D] 11
54. 080324b, P.I. A2.A.74  
The triangular top of a table has two sides of 14 inches and 16 inches, and the angle between the sides is  $30^\circ$ . Find the area of the tabletop, in square inches.

55. 010707b, P.I. A2.S.4  
The term “snowstorms of note” applies to all snowfalls over 6 inches. The snowfall amounts for snowstorms of note in Utica, New York, over a four-year period are as follows: 7.1, 9.2, 8.0, 6.1, 14.4, 8.5, 6.1, 6.8, 7.7, 21.5, 6.7, 9.0, 8.4, 7.0, 11.5, 14.1, 9.5, 8.6. What are the mean and population standard deviation for these data, to the nearest hundredth?

- [A] mean = 9.46; standard deviation = 3.85  
[B] mean = 9.45; standard deviation = 3.85  
[C] mean = 9.45; standard deviation = 3.74  
[D] mean = 9.46; standard deviation = 3.74

56. 010927b, P.I. A2.S.4  
The average monthly high temperatures, in degrees Fahrenheit, for Binghamton, New York, are given below.

January	28	July	78
February	31	August	76
March	41	September	68
April	53	October	57
May	68	November	44
June	73	December	33

For these temperatures, find, to the nearest tenth, the mean, the population standard deviation, and the number of months that fall within one standard deviation of the mean.

57. 010818b, P.I. A2.A.57  
The expression  $\cos(\pi - x)$  is equivalent to
- [A]  $\cos x$       [B]  $\sin x$   
[C]  $-\sin x$       [D]  $-\cos x$

58. 010526b, P.I. A2.A.61  
An arc of a circle that is 6 centimeters in length intercepts a central angle of 1.5 radians. Find the number of centimeters in the radius of the circle.

59. 060826b, P.I. A2.S.5  
The weights of the boxes of animal crackers coming off an assembly line differ slightly and form a normal distribution whose mean is 9.8 ounces and whose standard deviation is 0.6 ounce. Determine the number of boxes of animal crackers in a shipment of 5,000 boxes that are expected to weigh *more than* 11 ounces.

60. 060723b, P.I. G.G.53  
In the accompanying diagram of circle  $O$ , chords  $\overline{AB}$  and  $\overline{CD}$  intersect at  $E$ . If  $AE = 3$ ,  $EB = 4$ ,  $CE = x$ , and  $ED = x - 4$ , what is the value of  $x$ ?

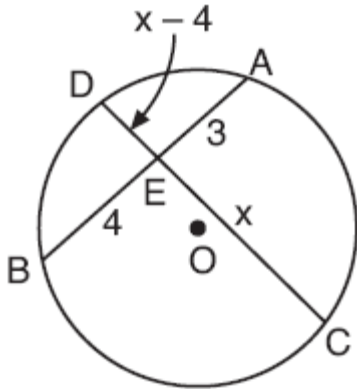

61. fall9929b, P.I. A2.A.73  
The Vietnam Veteran's Memorial in Washington, DC consists of two walls of black, polished granite, each 246.75 feet long, which meet at an angle of  $125.2^\circ$ . If extended, the west wall would reach to the Lincoln Memorial, 900 feet away from the end of the wall and the east wall would reach to the Washington Monument, 3,500 feet away from the end of the wall. Find the distance between the Lincoln Memorial and the Washington Monument to the *nearest foot*.

62. 010401b, P.I. A2.A.76  
The expression  $\cos 40^\circ \cos 10^\circ + \sin 40^\circ \sin 10^\circ$  is equivalent to
- [A]  $\sin 30^\circ$                       [B]  $\sin 50^\circ$   
[C]  $\cos 30^\circ$                       [D]  $\cos 50^\circ$

63. 010631b, P.I. A2.A.73  
The Vietnam Veterans Memorial in Washington, D.C., is made up of two walls, each 246.75 feet long, that meet at an angle of  $125.2^\circ$ . Find, to the *nearest foot*, the distance between the ends of the walls that do not meet.

64. 010308b, P.I. A2.S.5  
The national mean for verbal scores on an exam was 428 and the standard deviation was 113. Approximately what percent of those taking this test had verbal scores between 315 and 541?

- [A] 26.4%                              [B] 38.2%  
[C] 68.2%                              [D] 52.8%

65. 080613b, P.I. G.G.31  
If the perimeter of an equilateral triangle is 18, the length of the altitude of this triangle is

- [A] 3                      [B]  $6\sqrt{3}$                       [C]  $3\sqrt{3}$                       [D] 6

66. 010809b, P.I. A2.S.5  
On a standardized test with a normal distribution, the mean was 64.3 and the standard deviation was 5.4. What is the best approximation of the percent of scores that fell between 61.6 and 75.1?

- [A] 68.2%                              [B] 95%  
[C] 66.8%                              [D] 38.2%

67. 060333b  
A farmer has determined that a crop of strawberries yields a yearly profit of \$1.50 per square yard. If strawberries are planted on a triangular piece of land whose sides are 50 yards, 75 yards, and 100 yards, how much profit, to the *nearest hundred dollars*, would the farmer expect to make from this piece of land during the next harvest?

68. 010403b, P.I. G.G.48

An overhead view of a revolving door is shown in the accompanying diagram. Each panel is 1.5 meters wide.

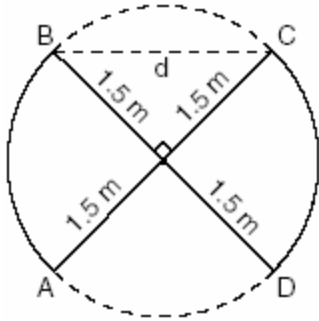

What is the approximate width of  $d$ , the opening from  $B$  to  $C$ ?

- [A] 2.12 m                      [B] 3.00 m  
[C] 1.73 m                      [D] 1.50 m

69. 060608b, P.I. A2.A.72

A radio transmitter sends a radio wave from the top of a 50-foot tower. The wave is represented by the accompanying graph.

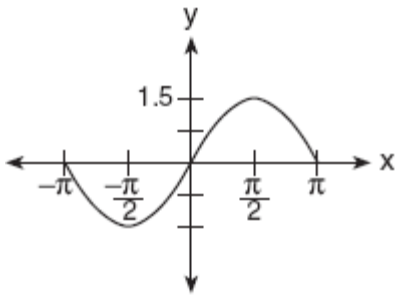

What is the equation of this radio wave?

- [A]  $y = \sin x$                       [B]  $y = \sin 1.5x$   
[C]  $y = 1.5 \sin x$                       [D]  $y = 2 \sin x$

70. 010723b

In  $\triangle ABC$ ,  $AC = 18$ ,  $BC = 10$ , and  $\cos C = \frac{1}{2}$ . Find the area of  $\triangle ABC$  to the nearest tenth of a square unit.

71. 060620b, P.I. A2.A.75

Sam needs to cut a triangle out of a sheet of paper. The only requirements that Sam must follow are that one of the angles must be  $60^\circ$ , the side opposite the  $60^\circ$  angle must be 40 centimeters, and one of the other sides must be 15 centimeters. How many different triangles can Sam make?

- [A] 1                      [B] 2                      [C] 3                      [D] 0

72. 060603b, P.I. G.G.52

In the accompanying diagram of circle  $O$ , chord  $\overline{AY}$  is parallel to diameter  $\overline{DOE}$ ,  $\overline{AD}$  is drawn, and  $m\widehat{AD} = 40$ .

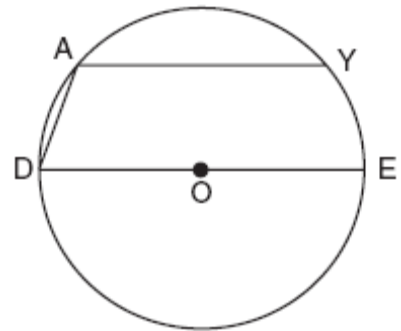

What is  $m\angle DAY$ ?

- [A] 130                      [B] 110                      [C] 150                      [D] 90

73. 080504b, P.I. G.G.31

The accompanying diagram shows two cables of equal length supporting a pole. Both cables are 14 meters long, and they are anchored to points in the ground that are 14 meters apart.

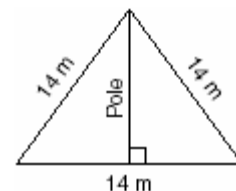

What is the exact height of the pole, in meters?

- [A] 14                      [B] 7                      [C]  $7\sqrt{2}$                       [D]  $7\sqrt{3}$

74. 060711b, P.I. A2.A.72

Which equation is represented by the accompanying graph?

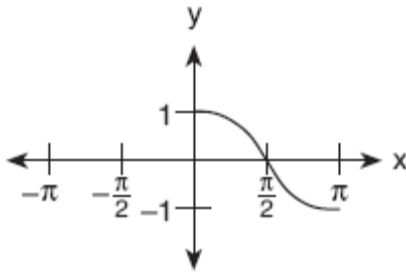

- [A]  $y = \frac{1}{2} \cos x$       [B]  $y = \cos x$   
 [C]  $y = \cos \frac{1}{2} x$       [D]  $y = \cos 2x$

75. 080629b, P.I. G.G.51

A machine part consists of a circular wheel with an inscribed triangular plate, as shown in the accompanying diagram. If  $\overline{SE} \cong \overline{EA}$ ,  $SE = 10$ , and  $m\widehat{SE} = 140$ , find the length of  $\overline{SA}$  to the nearest tenth.

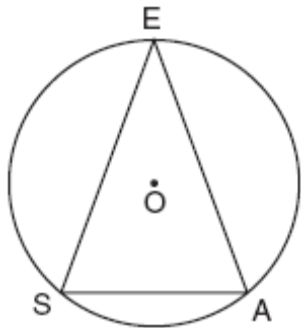

76. 060118b

If  $\theta$  is an obtuse angle and  $\sin \theta = b$ , then it can be concluded that

- [A]  $\cos \theta > b$       [B]  $\tan \theta > b$   
 [C]  $\cos 2\theta > b$       [D]  $\sin 2\theta < b$

77. 010821b, P.I. G.G.53

In the accompanying diagram,  $\overline{AB}$  is tangent to circle  $O$  at  $B$ . If  $AC = 16$  and  $CD = 9$ , what is the length of  $\overline{AB}$ ?

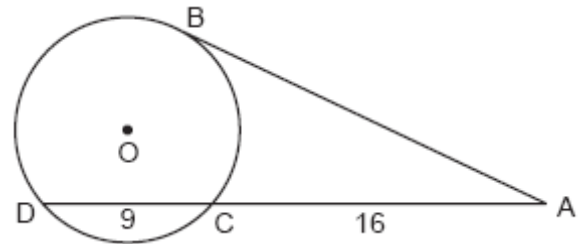

78. 010215b

Every time the pedals go through a  $360^\circ$  rotation on a certain bicycle, the tires rotate three times. If the tires are 24 inches in diameter, what is the minimum number of complete rotations of the pedals needed for the bicycle to travel at least 1 mile?

- [A] 12    [B] 281    [C] 5,280    [D] 561

79. 010534b, P.I. A2.A.73

A sign 46 feet high is placed on top of an office building. From a point on the sidewalk level with the base of the building, the angle of elevation to the top of the sign and the angle of elevation to the bottom of the sign are  $40^\circ$  and  $32^\circ$ , respectively. Sketch a diagram to represent the building, the sign, and the two angles, and find the height of the building to the nearest foot.

80. 080703b, P.I. A2.A.58

If  $\csc \theta = -2$ , what is the value of  $\sin \theta$ ?

- [A]  $\frac{1}{2}$     [B]  $-\frac{1}{2}$     [C]  $-2$     [D]  $2$

81. fall9912b, P.I. A2.S.5

The scores on a 100 point exam are normally distributed with a mean of 80 and a standard deviation of 6. A student's score places him between the 69th and 70th percentile. Which of the following best represents his score?

- [A] 86    [B] 84    [C] 81    [D] 66

82. 080225b, P.I. G.G.53

A toy truck is located within a circular play area. Alex and Dominic are sitting on opposite endpoints of a chord that contains the truck. Alex is 4 feet from the truck, and Dominic is 3 feet from the truck. Meira and Tamara are sitting on opposite endpoints of another chord containing the truck. Meira is 8 feet from the truck. How many feet, to the nearest tenth of a foot, is Tamara from the truck? Draw a diagram to support your answer.

83. 010718b, P.I. A2.A.62

In the unit circle shown in the accompanying diagram, what are the coordinates of  $(x, y)$ ?

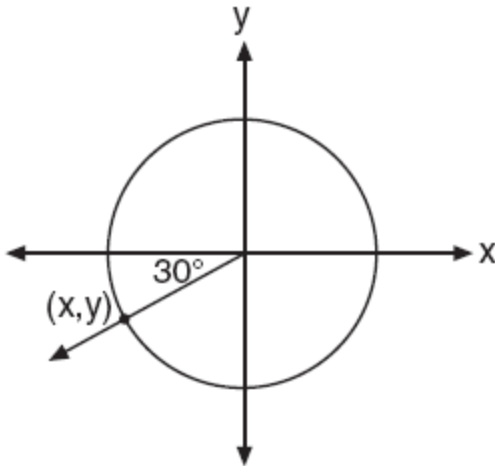

[A]  $(-\frac{\sqrt{2}}{2}, -\frac{\sqrt{2}}{2})$       [B]  $(-\frac{\sqrt{3}}{2}, -0.5)$

[C]  $(-0.5, -\frac{\sqrt{3}}{2})$       [D]  $(-30, -210)$

84. 080118b, P.I. A2.A.27

Determine the value of  $x$  and  $y$  if  $2^y = 8^x$  and  $3^y = 3^{x+4}$ .

[A]  $x = y$       [B]  $x = 2, y = 6$

[C]  $x = 6, y = 2$       [D]  $x = -2, y = -6$

85. 080633b, P.I. G.G.53

In the accompanying diagram, circle  $O$  has radius  $\overline{OD}$ , diameter  $\overline{BOHF}$ , secant  $\overline{CBA}$ , and chords  $\overline{DHG}$  and  $\overline{BD}$ ;  $\overline{CE}$  is tangent to circle  $O$  at  $D$ ;  $m\widehat{DF} = 80$ ; and  $m\widehat{BA} : m\widehat{AG} : m\widehat{GF} = 3 : 2 : 1$ . Find  $m\widehat{GF}$ , and  $m\angle BHD$ ,  $m\angle BDG$ ,  $m\angle GDE$ ,  $m\angle C$ , and  $m\angle BOD$ .

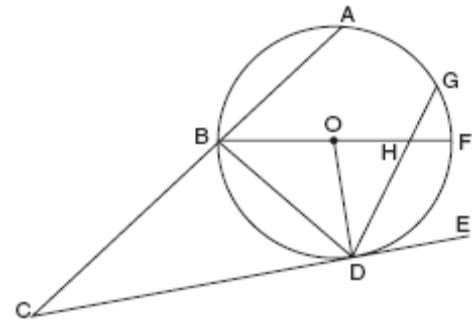

86. 010301b, P.I. A2.A.69

A monitor displays the graph  $y = 3\sin 5x$ . What will be the amplitude after a dilation of 2?

[A] 10      [B] 6      [C] 5      [D] 7

87. 060302b, P.I. A2.A.58

If  $\sin \theta > 0$  and  $\sec \theta < 0$ , in which quadrant does the terminal side of angle  $\theta$  lie?

[A] III      [B] IV      [C] II      [D] I

88. 080121b, P.I. A2.A.60

If the sine of an angle is  $\frac{3}{5}$  and the angle is not in Quadrant I, what is the value of the cosine of the angle?

89. 080410b, P.I. A2.A.58

If the tangent of an angle is negative and its secant is positive, in which quadrant does the angle terminate?

[A] II      [B] I      [C] III      [D] IV

90. 080306b, P.I. A2.S.8

Which graph represents data used in a linear regression that produces a correlation coefficient closest to  $-1$ ?

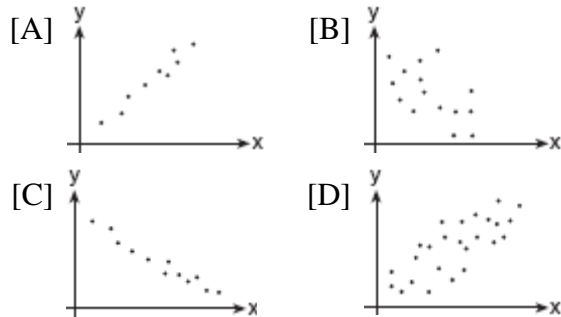

91. 010924b

In the accompanying diagram of parallelogram  $ABCD$ ,  $m\angle A = 30$ ,  $AB = 10$ , and  $AD = 6$ . What is the area of parallelogram  $ABCD$ ?

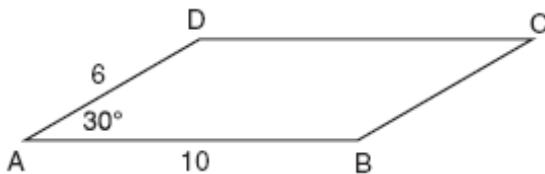

92. 060626b, P.I. A2.A.61

The pendulum of a clock swings through an angle of 2.5 radians as its tip travels through an arc of 50 centimeters. Find the length of the pendulum, in centimeters.

93. 010720b, P.I. A2.A.75

In  $\triangle ABC$ ,  $m\angle A = 30$ ,  $a = 14$ , and  $b = 20$ . Which type of angle is  $\angle B$ ?

- [A] It must be a right angle.
- [B] It must be an obtuse angle.
- [C] It must be an acute angle.
- [D] It may be either an acute angle or an obtuse angle.

94. 080623b, P.I. A2.M.2

What is the number of degrees in an angle whose radian measure is  $\frac{7\pi}{12}$ ?

95. 010702b, P.I. A2.A.73

The accompanying diagram shows the approximate linear distances traveled by a sailboat during a race. The sailboat started at point  $S$ , traveled to points  $E$  and  $A$ , respectively, and ended at point  $S$ .

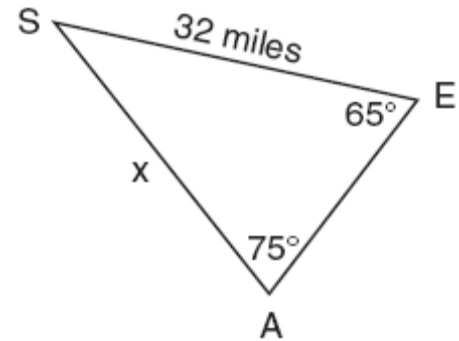

Based on the measures shown in the diagram, which equation can be used to find  $x$ , the distance from point  $A$  to point  $S$ ?

- [A]  $\frac{x}{\sin 65^\circ} = \frac{\sin 75^\circ}{32}$
- [B]  $\frac{\sin 65^\circ}{x} = \frac{\sin 75^\circ}{32}$
- [C]  $\frac{65}{x} = \frac{32}{75}$
- [D]  $\frac{x}{65} = \frac{32}{75}$

96. 080524b, P.I. A2.A.61

The accompanying diagram shows the path of a cart traveling on a circular track of radius 2.40 meters. The cart starts at point  $A$  and stops at point  $B$ , moving in a counterclockwise direction. What is the length of minor arc  $AB$ , over which the cart traveled, to the nearest tenth of a meter?

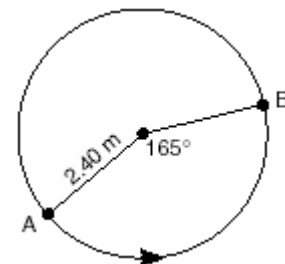

97. 010604b

On a standardized test, a score of 86 falls exactly 1.5 standard deviations below the mean. If the standard deviation for the test is 2, what is the mean score for this test?

- [A] 87.5 [B] 84.5 [C] 84 [D] 89

98. 080316b, P.I. A2.A.76

If  $\sin x = \frac{12}{13}$ ,  $\cos y = \frac{3}{5}$ , and  $x$  and  $y$  are acute angles, the value of  $\cos(x - y)$  is

- [A]  $-\frac{14}{65}$  [B]  $\frac{21}{65}$  [C]  $-\frac{33}{65}$  [D]  $\frac{63}{65}$

99. 010417b, P.I. A.G.1

A garden in the shape of an equilateral triangle has sides whose lengths are 10 meters. What is the area of the garden?

- [A]  $50\sqrt{3} \text{ m}^2$  [B]  $25 \text{ m}^2$   
[C]  $50 \text{ m}^2$  [D]  $25\sqrt{3} \text{ m}^2$

100. 060531b, P.I. A2.A.61

Kathy and Tami are at point  $A$  on a circular track that has a radius of 150 feet, as shown in the accompanying diagram. They run counterclockwise along the track from  $A$  to  $S$ , a distance of 247 feet. Find, to the nearest degree, the measure of minor arc  $AS$ .

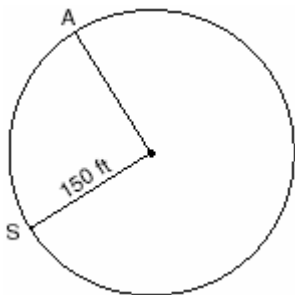

101. 060802b, G.G.51

In the accompanying diagram of circle  $O$ ,  $\overline{AB}$  and  $\overline{BC}$  are chords and  $m\angle AOC = 96$ . What is  $m\angle ABC$ ?

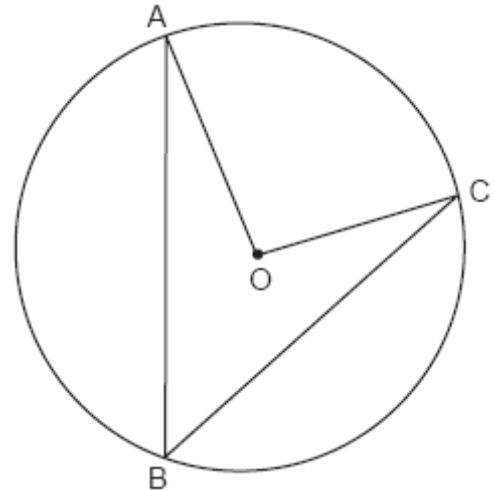

- [A] 32 [B] 96 [C] 192 [D] 48

102. 060811b, P.I. G.G.52

In the accompanying diagram of circle  $O$ ,  $\widehat{AB} \cong \widehat{CD}$ .

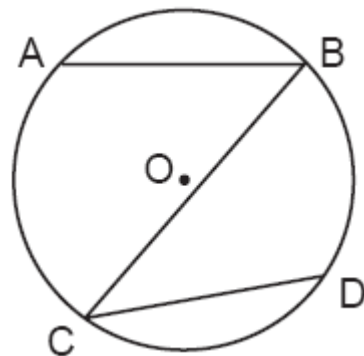

Which statement is true?

- [A]  $\overline{AB} \cong \overline{CD}$  [B]  $\overline{AB} \parallel \overline{CD}$   
[C]  $\widehat{AC} \cong \widehat{BD}$  [D]  $\angle ABC \cong \angle BCD$



103. 080311b, P.I. A2.A.75  
An architect commissions a contractor to produce a triangular window. The architect describes the window as  $\triangle ABC$ , where  $m\angle A = 50$ ,  $BC = 10$  inches, and  $AB = 12$  inches. How many distinct triangles can the contractor construct using these dimensions?

[A] 2 [B] 0 [C] 1 [D] more than 2

104. 060705b, P.I. A2.S.8  
What could be the approximate value of the correlation coefficient for the accompanying scatter plot?

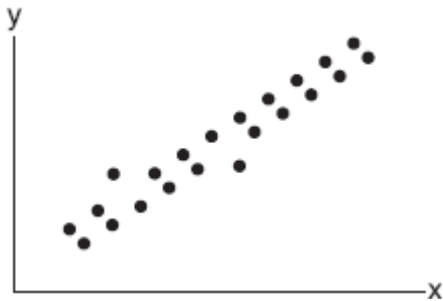

[A] -0.16 [B] 0.21 [C] -0.85 [D] 0.90

105. 080233b, P.I. A2.A.73  
Carmen and Jamal are standing 5,280 feet apart on a straight, horizontal road. They observe a hot-air balloon between them directly above the road. The angle of elevation from Carmen is  $60^\circ$  and from Jamal is  $75^\circ$ . Draw a diagram to illustrate this situation and find the height of the balloon to the nearest foot.

106. 010418b, P.I. A2.A.77  
If  $x$  is an acute angle and  $\sin x = \frac{12}{13}$ , then  $\cos 2x$  equals

[A]  $-\frac{25}{169}$  [B]  $-\frac{119}{169}$   
[C]  $\frac{25}{169}$  [D]  $\frac{119}{169}$

107. 060203b, P.I. G.G.53  
In the accompanying diagram, the length of  $\widehat{ABC}$  is  $\frac{3\pi}{2}$  radians.

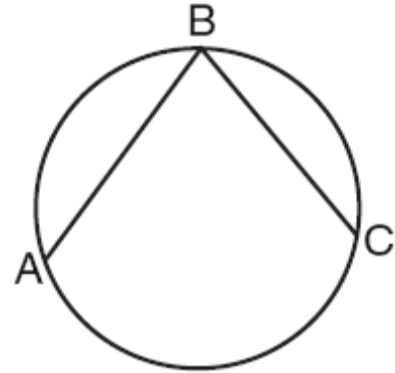

(Not drawn to scale)

What is  $m\angle ABC$ ?

[A] 72 [B] 53 [C] 36 [D] 45

108. 060319b, P.I. A2.A.68  
What value of  $x$  in the interval  $0^\circ \leq x \leq 180^\circ$  satisfies the equation  $\sqrt{3} \tan x + 1 = 0$ ?
- [A]  $30^\circ$  [B]  $-30^\circ$  [C]  $60^\circ$  [D]  $150^\circ$

109. 010330b  
A picnic table in the shape of a regular octagon is shown in the accompanying diagram. If the length of  $\overline{AE}$  is 6 feet, find the length of one side of the table to the nearest tenth of a foot, and find the area of the table's surface to the nearest tenth of a square foot.

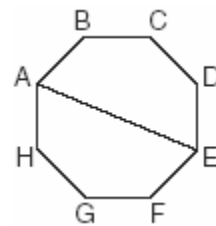



110. 010406b, P.I. A2.S.4  
Jean's scores on five mathematics tests were 98, 97, 99, 98, and 96. Her scores on five English tests were 78, 84, 95, 72, and 79. Which statement is true about the standard deviations for the scores?
- [A] The standard deviation for the English scores is greater than the standard deviation for the math scores.
- [B] The standard deviation for the math scores is greater than the standard deviation for the English scores.
- [C] More information is needed to determine the relationship between the standard deviations.
- [D] The standard deviations for both sets of scores are equal.

111. 080615b, P.I. A2.A.69  
What is the period of the graph of the equation  $y = 2 \sin \frac{1}{3}x$ ?
- [A]  $\frac{3\pi}{2}$     [B]  $6\pi$     [C]  $\frac{2}{3}\pi$     [D]  $2\pi$

112. 060126b, P.I. A2.S.5  
Professor Bartrich has 184 students in her mathematics class. The scores on the final examination are normally distributed and have a mean of 72.3 and a standard deviation of 8.9. How many students in the class can be expected to receive a score between 82 and 90?

113. 060434b, P.I. A2.A.73  
A surveyor is mapping a triangular plot of land. He measures two of the sides and the angle formed by these two sides and finds that the lengths are 400 yards and 200 yards and the included angle is  $50^\circ$ . What is the measure of the third side of the plot of land, to the nearest yard? What is the area of this plot of land, to the nearest square yard?

114. 010407b, P.I. A2.A.73  
In  $\triangle ABC$ ,  $a = 19$ ,  $c = 10$ , and  $m\angle A = 111$ . Which statement can be used to find the value of  $\angle C$ ?

[A]  $\sin C = \frac{10}{19}$                       [B]  $\sin C = \frac{19 \sin 69^\circ}{10}$

[C]  $\sin C = \frac{10 \sin 21^\circ}{19}$

[D]  $\sin C = \frac{10 \sin 69^\circ}{19}$

115. fall9914b, G.G.53  
In the diagram below, circle  $O$  has  $m\angle ABC = z$ . What is  $m\angle AOC$ ?

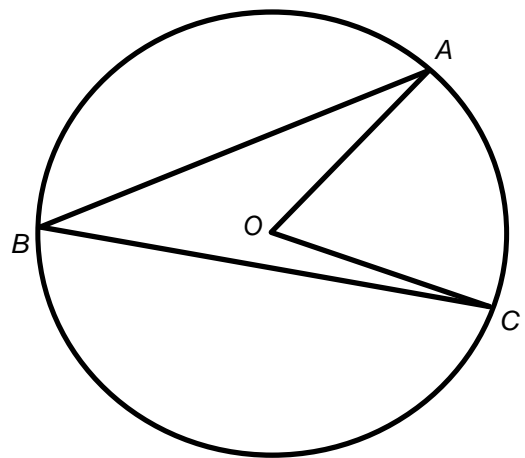

- [A]  $\frac{1}{2}z$     [B]  $2z$     [C]  $z$     [D]  $z^2$

116. 080815b, P.I. A2.A.70

Which graph represents a sound wave that follows a curve whose period is  $\pi$  and that is in the form  $y = a \sin bx$ ?

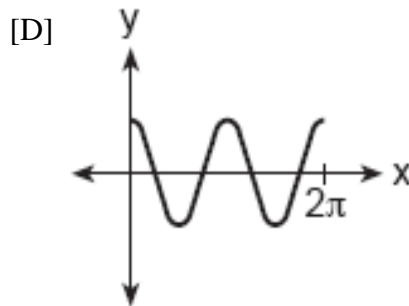
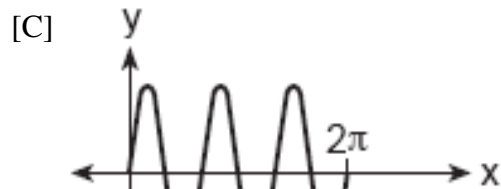
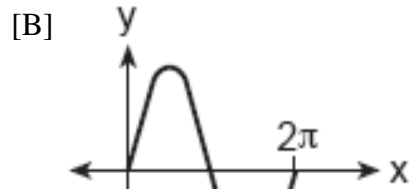

117. 010421b

Kristine is riding in car 4 of the Ferris wheel represented in the accompanying diagram. The Ferris wheel is rotating in the direction indicated by the arrows. The eight cars are equally spaced around the circular wheel. Express, in radians, the measure of the *smallest* angle through which she will travel to reach the bottom of the Ferris wheel.

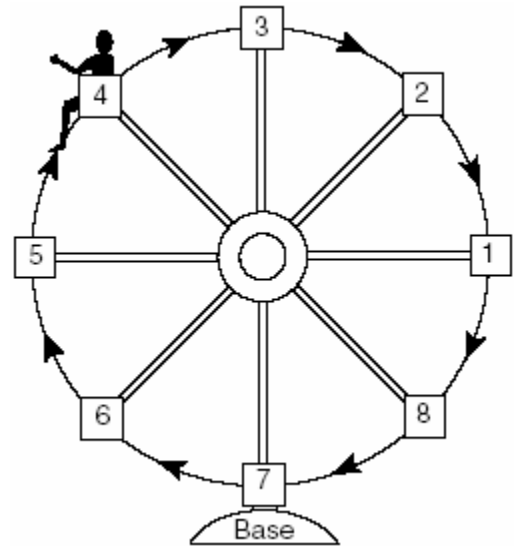

118. 010806b, P.I. A2.A.61

Jack wants to plant a border of flowers in the shape of an arc along the edge of a circular walkway. If the circle has a radius of 5 yards and the angle subtended by the arc measures  $1\frac{1}{2}$  radians, what is the length, in yards, of the border?

- [A] 5      [B] 2      [C] 7.5      [D] 0.5

119. 060817b, P.I. A2.A.73

Al is standing 50 yards from a maple tree and 30 yards from an oak tree in the park. His position is shown in the accompanying diagram. If he is looking at the maple tree, he needs to turn his head  $120^\circ$  to look at the oak tree.

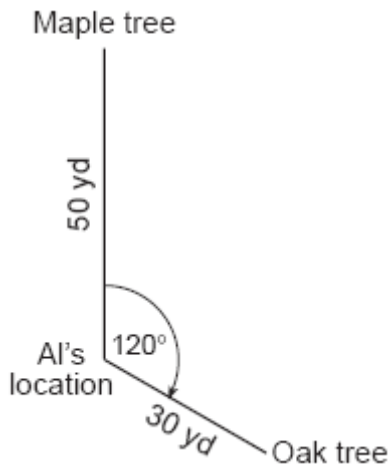

How many yards apart are the two trees?

- [A] 65.2 [B] 58.3 [C] 75 [D] 70

120. 010722b

The accompanying diagram shows a revolving door with three panels, each of which is 4 feet long. What is the width,  $w$ , of the opening between  $x$  and  $y$ , to the *nearest tenth of a foot*?

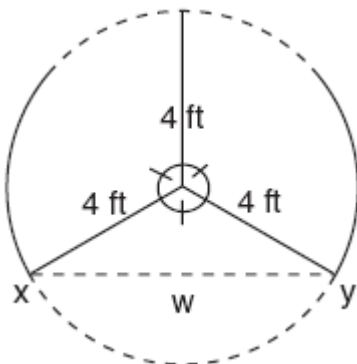

121. 060232b, P.I. A2.A.73

Kieran is traveling from city  $A$  to city  $B$ . As the accompanying map indicates, Kieran could drive directly from  $A$  to  $B$  along County Route 21 at an average speed of 55 miles per hour or travel on the interstates, 45 miles along I-85 and 20 miles along I-64. The two interstates intersect at an angle of  $150^\circ$  at  $C$  and have a speed limit of 65 miles per hour. How much time will Kieran save by traveling along the interstates at an average speed of 65 miles per hour?

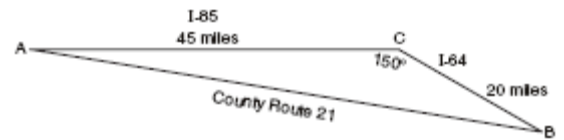

122. 010223b, P.I. A2.A.61

A ball is rolling in a circular path that has a radius of 10 inches, as shown in the accompanying diagram. What distance has the ball rolled when the subtended arc is  $54^\circ$ ? Express your answer to the *nearest hundredth of an inch*.

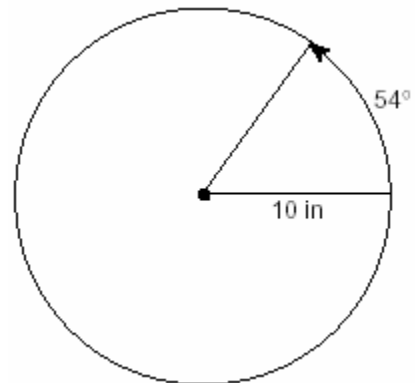

123. 080426b, P.I. A2.A.61  
Cities  $H$  and  $K$  are located on the same line of longitude and the difference in the latitude of these cities is  $9^\circ$ , as shown in the accompanying diagram. If Earth's radius is 3,954 miles, how many miles north of city  $K$  is city  $H$  along arc  $HK$ ? Round your answer to the nearest tenth of a mile.

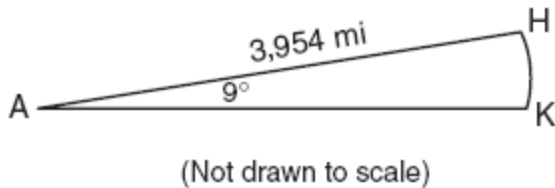

124. 010619b, P.I. G.G.47  
The accompanying diagram shows a 24-foot ladder leaning against a building. A steel brace extends from the ladder to the point where the building meets the ground. The brace forms a right angle with the ladder.

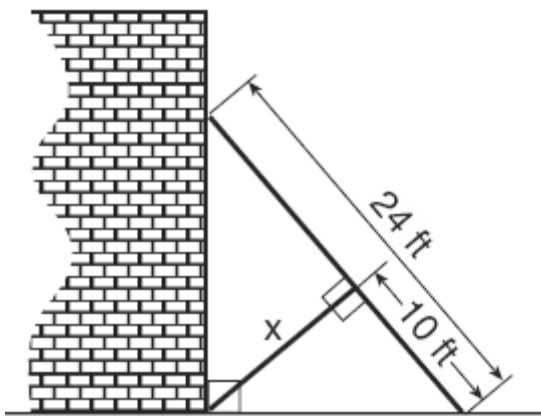

If the steel brace is connected to the ladder at a point that is 10 feet from the foot of the ladder, which equation can be used to find the length,  $x$ , of the steel brace?

- [A]  $\frac{10}{x} = \frac{x}{24}$       [B]  $\frac{10}{x} = \frac{x}{14}$   
[C]  $10^2 + x^2 = 14^2$       [D]  $10^2 + x^2 = 24^2$

125. 080232b, P.I. A2.S.7  
The breaking strength,  $y$ , in tons, of steel cable with diameter  $d$ , in inches, is given in the table below.

$d$ (in)	$y$ (tons)
0.50	9.85
0.75	21.80
1.00	38.30
1.25	59.20
1.50	84.40
1.75	114.00

On the accompanying grid, make a scatter plot of these data. Write the exponential regression equation, expressing the regression coefficients to the nearest tenth.

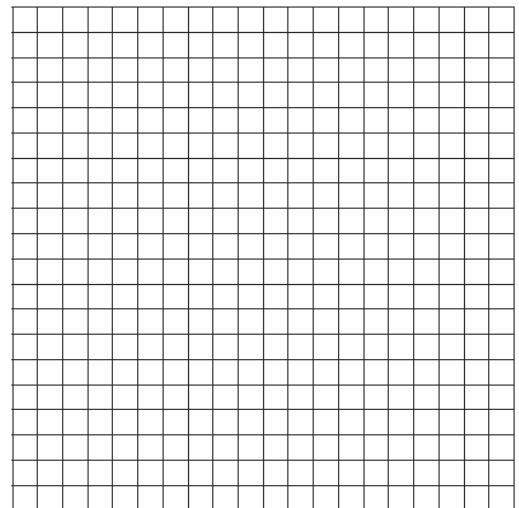

126. 060332b, P.I. A2.A.73

While sailing a boat offshore, Donna sees a lighthouse and calculates that the angle of elevation to the top of the lighthouse is  $3^\circ$ , as shown in the accompanying diagram. When she sails her boat 700 feet closer to the lighthouse, she finds that the angle of elevation is now  $5^\circ$ . How tall, to the *nearest tenth of a foot*, is the lighthouse?

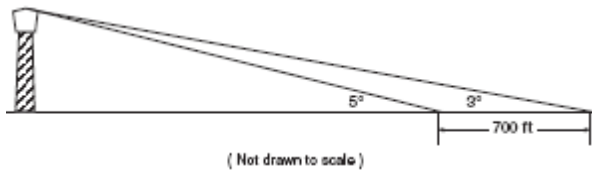

127. 080214b, P.I. A2.A.73

In the accompanying diagram of  $\triangle ABC$ ,  $m\angle A = 30$ ,  $m\angle C = 50$ , and  $AC = 13$ .

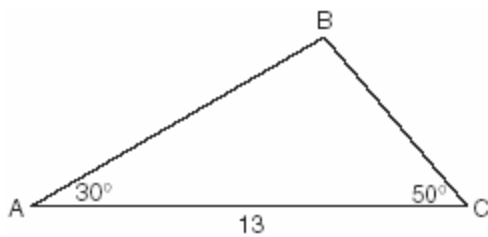

What is the length of side  $\overline{AB}$  to the *nearest tenth*?

- [A] 12.0 [B] 10.1 [C] 6.6 [D] 11.5

128. 060114b

A bug travels up a tree, from the ground, over a 30-second interval. It travels fast at first and then slows down. It stops for 10 seconds, then proceeds slowly, speeding up as it goes. Which sketch best illustrates the bug's distance ( $d$ ) from the ground over the 30-second interval ( $t$ )?

- [A] [B] [C] [D]

129. 010929b, P.I. A2.A.73

In  $\triangle ABC$ ,  $a = 24$ ,  $b = 36$ , and  $c = 30$ . Find  $m\angle A$  to the *nearest tenth of a degree*.

130. 080117b, P.I. A.A.18

If the length of a rectangular garden is represented by  $\frac{x^2 + 2x}{x^2 + 2x - 15}$  and its width is represented by  $\frac{2x - 6}{2x + 4}$ , which expression represents the area of the garden?

- [A]  $\frac{x^2 + 2x}{2(x + 5)}$  [B]  $\frac{x}{x + 5}$   
[C]  $x + 5$  [D]  $x$

131. 080123b, P.I. A2.A.5

The price per person to rent a limousine for a prom varies inversely as the number of passengers. If five people rent the limousine, the cost is \$70 each. How many people are renting the limousine when the cost *per couple* is \$87.50?

132. 060527b, P.I. A2.A.73

As shown in the accompanying diagram, two tracking stations,  $A$  and  $B$ , are on an east-west line 110 miles apart. A forest fire is located at  $F$ , on a bearing  $42^\circ$  northeast of station  $A$  and  $15^\circ$  northeast of station  $B$ . How far, to the *nearest mile*, is the fire from station  $A$ ?

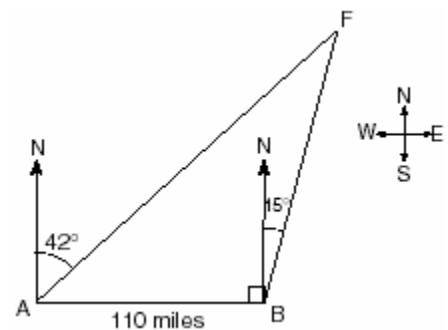

133. 060634b

A triangular plot of land has sides that measure 5 meters, 7 meters, and 10 meters. What is the area of this plot of land, to the nearest tenth of a square meter?

134. 060227b, P.I. A2.S.4

An electronics company produces a headphone set that can be adjusted to accommodate different-sized heads. Research into the distance between the top of people's heads and the top of their ears produced the following data, in inches: 4.5, 4.8, 6.2, 5.5, 5.6, 5.4, 5.8, 6.0, 5.8, 6.2, 4.6, 5.0, 5.4, 5.8. The company decides to design their headphones to accommodate three standard deviations from the mean. Find, to the nearest tenth, the mean, the standard deviation, and the range of distances that must be accommodated.

135. 080726b, P.I. G.G.48

The accompanying diagram shows ramp  $\overline{RA}$  leading to level platform  $\overline{AM}$ , forming an angle of  $45^\circ$  with level ground. If platform  $\overline{AM}$  measures 2 feet and is 6 feet above the ground, explain why the exact length of ramp  $\overline{RA}$  is  $6\sqrt{2}$  feet.

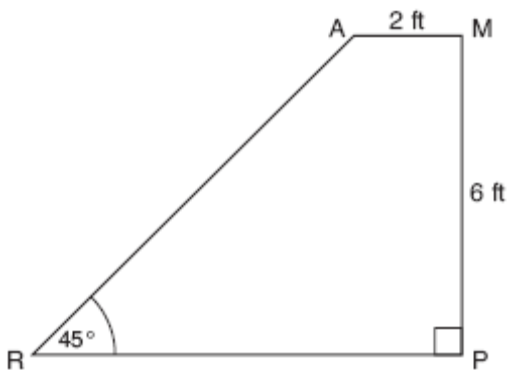

136. 060828b, P.I. G.G.47

Four streets in a town are illustrated in the accompanying diagram. If the distance on Poplar Street from  $F$  to  $P$  is 12 miles and the distance on Maple Street from  $E$  to  $M$  is 10 miles, find the distance on Maple Street, in miles, from  $M$  to  $P$ .

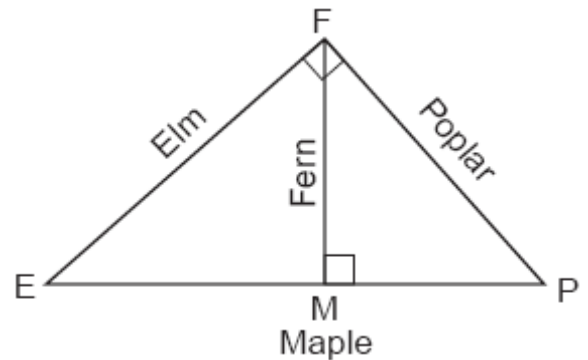

137. fall9920b, P.I. A2.A.62

The origin of a coordinate grid is labeled  $A$ . Line segment  $AB$  forms an angle of  $30^\circ$  with the  $x$ -axis. If  $AB = 8$ , the coordinates of  $B$  are:

- [A] (6, 4)      [B]  $(8 \cos 30^\circ, 8 \sin 30^\circ)$   
[C]  $(8 \sin 30^\circ, 8 \cos 30^\circ)$       [D]  $(4, 4\sqrt{3})$

138. 080417b, P.I. A2.A.57

Which angle is coterminal with an angle of  $125^\circ$ ?

- [A]  $425^\circ$       [B]  $235^\circ$   
[C]  $-125^\circ$       [D]  $-235^\circ$

139. 080405b, P.I. A2.S.5

The mean of a normally distributed set of data is 56, and the standard deviation is 5. In which interval do approximately 95.4% of all cases lie?

- [A] 46-56      [B] 46-66  
[C] 56-71      [D] 51-61

140. 060525b, P.I. A2.A.74  
A landscape architect is designing a triangular garden to fit in the corner of a lot. The corner of the lot forms an angle of  $70^\circ$ , and the sides of the garden including this angle are to be 11 feet and 13 feet, respectively. Find, to the *nearest integer*, the number of square feet in the area of the garden.
141. 060324b, P.I. A2.S.5  
In a certain school district, the ages of all new teachers hired during the last 5 years are normally distributed. Within this curve, 95.4% of the ages, centered about the mean, are between 24.6 and 37.4 years. Find the mean age and the standard deviation of the data.
142. 060704b, P.I. A2.A.74  
Jack is planting a triangular rose garden. The lengths of two sides of the plot are 8 feet and 12 feet, and the angle between them is  $87^\circ$ . Which expression could be used to find the area of this garden?
- [A]  $8 \cdot 12 \cdot \sin 87^\circ$       [B]  $\frac{1}{2} \cdot 8 \cdot 12 \cdot \cos 87^\circ$   
[C]  $8 \cdot 12 \cdot \cos 87^\circ$       [D]  $\frac{1}{2} \cdot 8 \cdot 12 \cdot \sin 87^\circ$
143. 060116b, P.I. A.M.1  
On her first trip, Sari biked 24 miles in  $T$  hours. The following week Sari biked 32 miles in  $T$  hours. Determine the ratio of her average speed on her second trip to her average speed on her first trip.
- [A]  $\frac{3}{4}$       [B]  $\frac{4}{3}$       [C]  $\frac{3}{2}$       [D]  $\frac{2}{3}$
144. 010212b, P.I. A2.A.73  
In  $\triangle ABC$ ,  $m\angle A = 33$ ,  $a = 12$ , and  $b = 15$ . What is  $m\angle B$  to the *nearest degree*?
- [A] 48      [B] 41      [C] 43      [D] 44
145. 080802b  
Tanner and Robbie discovered that the means of their grades for the first semester in Mrs. Merrell's mathematics class are identical. They also noticed that the standard deviation of Tanner's scores is 20.7, while the standard deviation of Robbie's scores is 2.7. Which statement must be true?
- [A] Robbie's grades are more consistent than Tanner's grades.  
[B] The median for Robbie's grades is lower than the median for Tanner's grades.  
[C] In general, Robbie's grades are lower than Tanner's grades.  
[D] Robbie had more failing grades during the semester than Tanner had.
146. 080829b, P.I. G.G.31  
A parcel of land is in the shape of an isosceles triangle. The base has a length of 673 feet and the two equal legs meet at an angle of  $43^\circ$ . Find, to the *nearest square foot*, the area of the parcel of land.
147. 060416b, P.I. A2.A.75  
Sam is designing a triangular piece for a metal sculpture. He tells Martha that two of the sides of the piece are 40 inches and 15 inches, and the angle opposite the 40-inch side measures  $120^\circ$ . Martha decides to sketch the piece that Sam described. How many different triangles can she sketch that match Sam's description?
- [A] 2      [B] 3      [C] 1      [D] 0

148. 080309b, P.I. A2.A.61

A dog has a 20-foot leash attached to the corner where a garage and a fence meet, as shown in the accompanying diagram. When the dog pulls the leash tight and walks from the fence to the garage, the arc the leash makes is 55.8 feet.

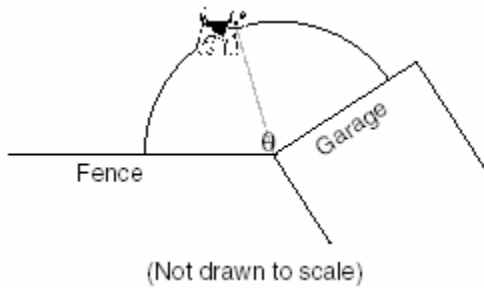

What is the measure of angle  $\theta$  between the garage and the fence, in radians?

- [A] 2.79 [B] 0.36 [C] 3.14 [D] 160

149. 010920b, P.I. G.G.47

The accompanying diagram shows part of the architectural plans for a structural support of a building.  $PLAN$  is a rectangle and  $\overline{AS} \perp \overline{LN}$ .

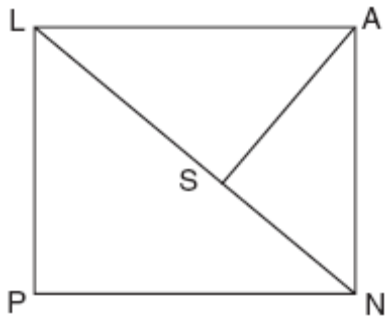

Which equation can be used to find the length of  $\overline{AS}$ ?

- [A]  $\frac{AS}{LS} = \frac{LS}{SN}$  [B]  $\frac{AN}{LN} = \frac{AS}{LS}$   
 [C]  $\frac{AS}{SN} = \frac{AS}{LS}$  [D]  $\frac{LS}{AS} = \frac{AS}{SN}$

150. 060220b, P.I. A2.A.44

Which graph represents the inverse of  $f(x) = \{(0,1), (1,4), (2,3)\}$ ?

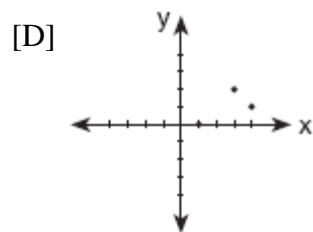
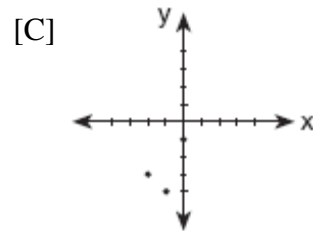
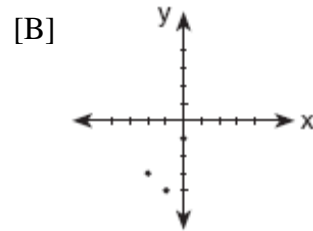
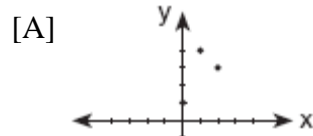

151. fall9924b, P.I. A2.S.5

A survey of the soda drinking habits of the population in a high school revealed the mean number of cans of soda consumed per person per week to be 20 with a standard deviation of 3.5. If a normal distribution is assumed, find an interval that contains the total number of cans per week approximately 95% of the population of this school will drink. Explain why you selected that interval.



152. 080604b, P.I. A2.A.67

If  $x$  is a positive acute angle and  $\cos x = \frac{\sqrt{3}}{4}$ ,  
what is the exact value of  $\sin x$ ?

- [A]  $\frac{\sqrt{3}}{5}$  [B]  $\frac{3}{5}$  [C]  $\frac{\sqrt{13}}{4}$  [D]  $\frac{4}{5}$

153. 060128b, P.I. A2.A.25

A homeowner wants to increase the size of a rectangular deck that now measures 15 feet by 20 feet, but building code laws state that a homeowner cannot have a deck larger than 900 square feet. If the length and the width are to be increased by the same amount, find, to the *nearest tenth*, the maximum number of feet that the length of the deck may be increased in size legally.

154. 010623b, P.I. G.G.53

In the accompanying diagram,  $\overline{PA}$  is tangent to circle  $O$  at  $A$ , secant  $\overline{PBC}$  is drawn,  $PB = 4$ , and  $BC = 12$ . Find  $PA$ .

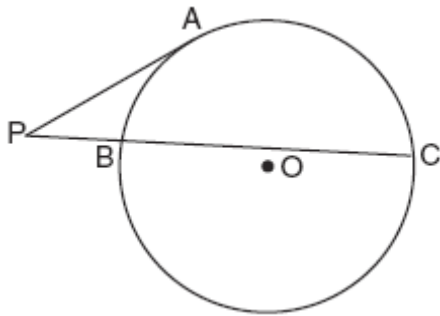

155. 080419b

The path traveled by a roller coaster is modeled by the equation  $y = 27 \sin 13x + 30$ .  
What is the maximum altitude of the roller coaster?

- [A] 57 [B] 30 [C] 13 [D] 27

156. 060622b, P.I. A2.A.73

In  $\triangle ABC$ ,  $m\angle A = 53$ ,  $m\angle B = 14$ , and  $a = 10$ . Find  $b$  to the *nearest integer*.

157. 060106b

The circumference of a circular plot of land is increased by 10%. What is the best estimate of the total percentage that the area of the plot increased?

- [A] 25% [B] 21% [C] 10% [D] 31%

158. 060818b, P.I. A2.A.61

A sprinkler system is set up to water the sector shown in the accompanying diagram, with angle  $ABC$  measuring 1 radian and radius  $AB = 20$  feet.

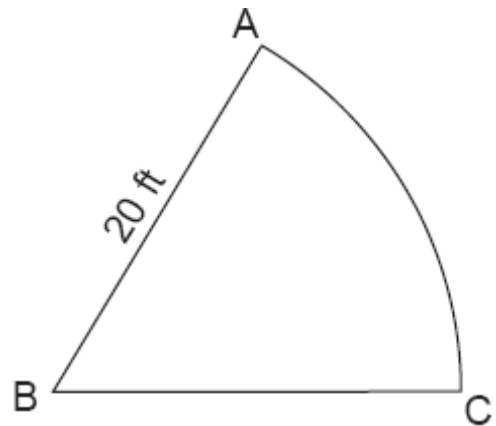

What is the length of arc  $AC$ , in feet?

- [A] 31 [B] 10 [C] 20 [D] 63

159. 010214b, P.I. A2.A.72

The accompanying diagram shows a section of a sound wave as displayed on an oscilloscope.

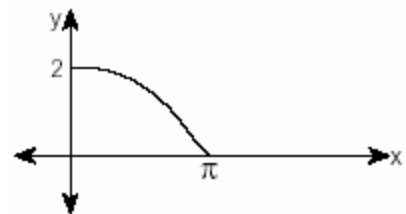

Which equation could represent this graph?

- [A]  $y = 2 \sin \frac{x}{2}$  [B]  $y = 2 \cos \frac{x}{2}$   
[C]  $y = \frac{1}{2} \cos 2x$  [D]  $y = \frac{1}{2} \sin \frac{\pi}{2} x$

160. 060119b, P.I. A2.A.75  
Main Street and Central Avenue intersect, making an angle measuring  $34^\circ$ . Angela lives at the intersection of the two roads, and Caitlin lives on Central Avenue 10 miles from the intersection. If Leticia lives 7 miles from Caitlin, which conclusion is valid?

- [A] Leticia can live at only one location on Main Street.  
[B] Leticia can live at one of two locations on Main Street.  
[C] Leticia cannot live on Main Street.  
[D] Leticia can live at one of three locations on Main Street.

161. 080115b, P.I. G.G.61  
The graph of  $f(x)$  is shown in the accompanying diagram.

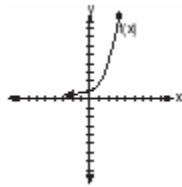

Which graph represents  $f(x)$  on the  $x$ -axis or  $y$ -axis?

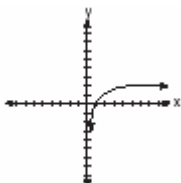
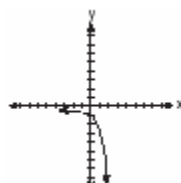
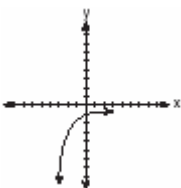
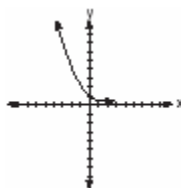
- [A]  [B] 
- [C]  [D] 

162. 010528b, P.I. A2.A.73  
To measure the distance through a mountain for a proposed tunnel, surveyors chose points  $A$  and  $B$  at each end of the proposed tunnel and a point  $C$  near the mountain. They determined that  $AC = 3,800$  meters,  $BC = 2,900$  meters, and  $m\angle ACB = 110$ . Draw a diagram to illustrate this situation and find the length of the tunnel, to the nearest meter.

163. 010510b, P.I. G.G.51  
A small fragment of something brittle, such as pottery, is called a shard. The accompanying diagram represents the outline of a shard from a small round plate that was found at an archaeological dig.



If  $\overline{BC}$  is a tangent to  $\widehat{AB}$  at  $B$  and  $m\angle ABC = 45$ , what is the measure of  $\widehat{AB}$ , the outside edge of the shard?

- [A]  $135^\circ$  [B]  $225^\circ$  [C]  $90^\circ$  [D]  $45^\circ$

164. 080734b  
A farmer has a triangular field with sides of 240 feet, 300 feet, and 360 feet. He wants to apply fertilizer to the field. If one 40-pound bag of fertilizer covers 6,000 square feet, how many bags must he buy to cover the field?

165. 080704b, P.I. A2.M.2  
What is  $235^\circ$ , expressed in radian measure?

- [A]  $\frac{36\pi}{47}$  [B]  $\frac{\pi}{235}$   
[C]  $235\pi$  [D]  $\frac{47\pi}{36}$

166. 060234b, P.I. A2.S.7

The table below, created in 1996, shows a history of transit fares from 1955 to 1995. On the accompanying grid, construct a scatter plot where the independent variable is years. State the exponential regression equation with the coefficient and base rounded to the *nearest thousandth*. Using this equation, determine the prediction that should have been made for the year 1998, to the *nearest cent*.

Year	Fare (\$)
55	0.10
60	0.15
65	0.20
70	0.30
75	0.40
80	0.60
85	0.80
90	1.15
95	1.50

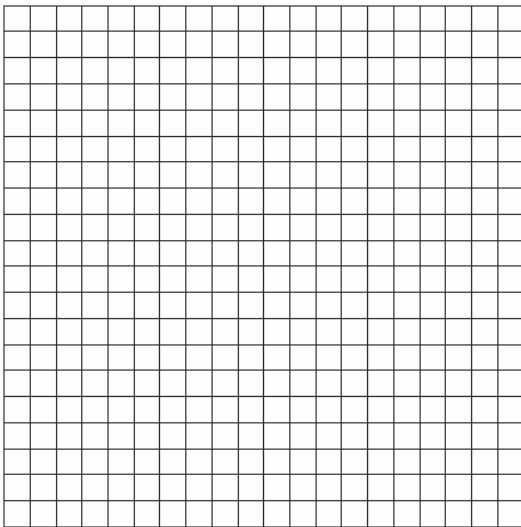

167. 010426b, P.I. A2.A.75

A landscape designer is designing a triangular garden with two sides that are 4 feet and 6 feet, respectively. The angle opposite the 4-foot side is  $30^\circ$ . How many distinct triangular gardens can the designer make using these measurements?

1. 010234b, P.I. A2.S.7

Two different tests were designed to measure understanding of a topic. The two tests were given to ten students with the following results:

Test $x$	75	78	88	92	95	67	58	72	74	81
Test $y$	81	73	85	88	89	73	66	75	70	78

Construct a scatter plot for these scores, and then write an equation for the line of best fit (round slope and intercept to the *nearest hundredth*).

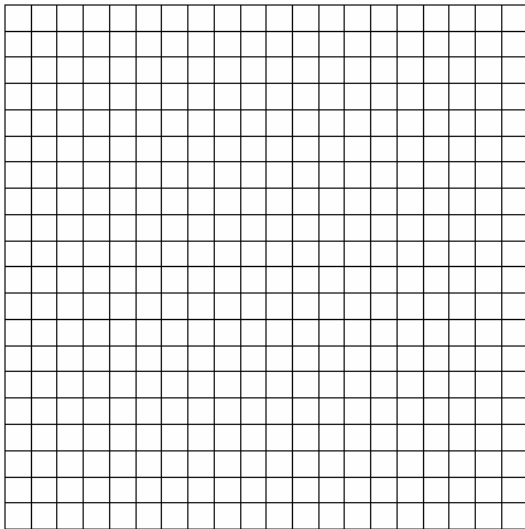

Find the correlation coefficient.  
Predict the score, to the *nearest integer*, on test  $y$  for a student who scored 87 on test  $x$ .

2. 010321b, P.I. A.S.4

Two social studies classes took the same current events examination that was scored on the basis of 100 points. Mr. Wong's class had a median score of 78 and a range of 4 points, while Ms. Rizzo's class had a median score of 78 and a range of 22 points. Explain how these classes could have the same median score while having very different ranges.

3. 010820b, P.I. A2.A.36

What is the coefficient of the fifth term in the expansion of  $(x + 1)^8$ ?

- [A] 56    [B] 28    [C] 8    [D] 70

4. 080533b, P.I. A2.S.7

The accompanying table illustrates the number of movie theaters showing a popular film and the film's weekly gross earnings, in millions of dollars.

Number of Theaters ( $x$ )	Gross Earnings ( $y$ ) (millions of dollars)
443	2.57
455	2.65
493	3.73
530	4.05
569	4.76
657	4.76
723	5.15
1,064	9.35

Write the linear regression equation for this set of data, rounding values to *five decimal places*. Using this linear regression equation, find the approximate gross earnings, in millions of dollars, generated by 610 theaters. Round your answer to *two decimal places*. Find the minimum number of theaters that would generate at least 7.65 million dollars in gross earnings in one week.

5. 060722b, P.I. A2.S.7

The accompanying table shows the enrollment of a preschool from 1980 through 2000. Write a linear regression equation to model the data in the table.

Year ( $x$ )	Enrollment ( $y$ )
1980	14
1985	20
1990	22
1995	28
2000	37

6. 010712b, P.I. A2.A.51

Data collected during an experiment are shown in the accompanying graph.

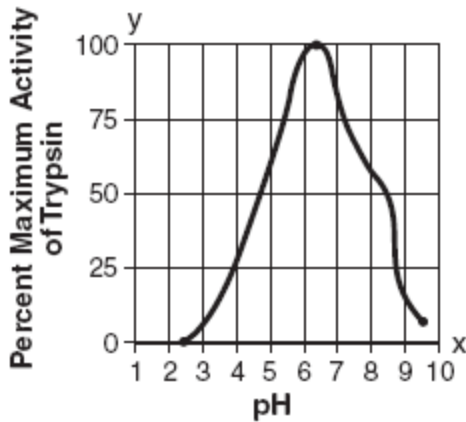

What is the range of this set of data?

- [A]  $2.5 \leq y \leq 9.5$       [B]  $2.5 \leq x \leq 9.5$   
 [C]  $0 \leq y \leq 100$       [D]  $1 \leq x \leq 10$

7. 080730b, P.I. A2.S.4

Mr. Koziol has 17 students in his high school golf club. Each student played one round of golf. The summarized scores of the students are listed in the accompanying table.

Score	Frequency
70	4
73	3
75	2
80	3
85	1
86	1
90	2
92	1

Find the population standard deviation of this set of students' scores, to the *nearest tenth*. How many of the individual students' golf scores fall within one population standard deviation of the mean?

8. 060122b, P.I. A2.S.15

At a certain intersection, the light for eastbound traffic is red for 15 seconds, yellow for 5 seconds, and green for 30 seconds. Find, to the *nearest tenth*, the probability that out of the next eight eastbound cars that arrive randomly at the light, exactly three will be stopped by a red light.

9. 080614b, P.I. A2.A.34

Jonathan's teacher required him to express the sum  $\frac{2}{3} + \frac{3}{4} + \frac{4}{5} + \frac{5}{6} + \frac{6}{7}$  using sigma notation. Jonathan proposed four possible answers. Which of these four answers is *not* correct?

- [A]  $\sum_{k=2}^6 \frac{k}{k+1}$       [B]  $\sum_{k=1}^5 \frac{k+1}{k+2}$   
 [C]  $\sum_{k=1}^5 \frac{k}{k+1}$       [D]  $\sum_{k=3}^7 \frac{k-1}{k}$

10. 060517b, P.I. A2.A.36

What is the third term in the expansion of  $(\cos x + 3)^5$ ?

- [A]  $270\cos^2 x$       [B]  $60\cos^3 x$   
 [C]  $90\cos^2 x$       [D]  $90\cos^3 x$

11. 080334b, P.I. A2.S.15

When Joe bowls, he can get a strike (knock down all the pins) 60% of the time. How many times more likely is it for Joe to bowl *at least* three strikes out of four tries as it is for him to bowl zero strikes out of four tries? Round your answer to the *nearest whole number*.

12. fall9922b, P.I. A2.S.15

Jim can drive a golf ball over 220 yards 40% of the time. He regularly plays on a golf course where drives of that distance are needed on 12 holes. Determine the probability that *exactly* 7 of his drives will be over 220 yards.

13. 080126b, P.I. A2.A.76

If  $\sin x = \frac{4}{5}$ , where  $0^\circ < x < 90^\circ$ , find the value of  $\cos (x + 180^\circ)$ .

14. 060432b, P.I. A2.S.5

Mrs. Ramírez is a real estate broker. Last month, the sale prices of homes in her area approximated a normal distribution with a mean of \$150,000 and a standard deviation of \$25,000. A house had a sale price of \$175,000. What is the percentile rank of its sale price, to the *nearest whole number*? Explain what that percentile means. Mrs. Ramírez told a customer that most of the houses sold last month had selling prices between \$125,000 and \$175,000. Explain why she is correct.

15. 010831b, P.I. A2.S.7

Water is draining from a tank maintained by the Yorkville Fire Department. Students measured the depth of the water in 15-second intervals and recorded the results in the accompanying table.

Time ( $x$ ) (in seconds)	Depth of Water ( $y$ ) (in feet)
15	11.8
30	9.9
45	8.2
60	6.3
75	5.9

Write the power regression equation for this set of data, rounding all values to the *nearest ten thousandth*. Using this equation, predict the depth of the water at 2 minutes, to the *nearest tenth of a foot*.

16. 010625b, P.I. A2.S.15

During a recent survey, students at Franconia College were asked if they drink coffee in the morning. The results showed that two-thirds of the students drink coffee in the morning and the remainder do not. What is the probability that of six students selected at random, *exactly* two of them drink coffee in the morning? Express your answer as a fraction or as a decimal rounded to *four decimal places*.

17. 080723b, P.I. A2.S.15

Mr. and Mrs. Doran have a genetic history such that the probability that a child being born to them with a certain trait is  $\frac{1}{8}$ . If they have four children, what is the probability that *exactly* three of their four children will have that trait?

18. 060331b, P.I. A2.S.15

On any given day, the probability that the entire Watson family eats dinner together is  $\frac{2}{5}$ . Find the probability that, during any 7-day period, the Watsons eat dinner together *at least* six times.

19. 010601b, P.I. A2.A.35

What is the value of  $\sum_{n=1}^5 (-2n + 100)$ ?

[A] 530 [B] 130 [C] 70 [D] 470

20. 010505b, P.I. A2.N.10

The value of  $\sum_{r=2}^4 {}_5C_r$  is

[A] 10 [B] 25 [C] 5 [D] 45

21. 080222b, P.I. A2.S.5  
The amount of time that a teenager plays video games in any given week is normally distributed. If a teenager plays video games an average of 15 hours per week, with a standard deviation of 3 hours, what is the probability of a teenager playing video games between 15 and 18 hours a week?

22. 010515b, P.I. A2.S.8  
Which scatter diagram shows the strongest positive correlation?

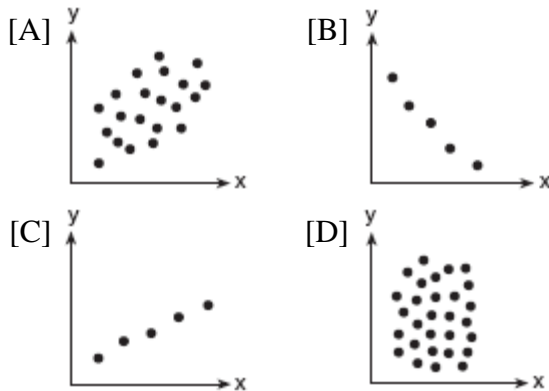

23. 010805b, P.I. A2.S.15  
Sean tells prospective clients that the probability of rain at the dive location is .2 each day. Which expression can be used to calculate the probability that it will rain on *exactly* 5 days of the 7 days at the dive location?

[A]  ${}_7C_5(.2)^2(.8)^5$       [B]  ${}_7C_2(.5)(.7)$   
[C]  ${}_7C_5(.5)(.7)$       [D]  ${}_7C_5(.2)^5(.8)^2$

24. 010726b, P.I. A2.A.36  
What is the fourth term in the expansion of  $(2x - y)^5$ ?

25. 060619b, P.I. A2.A.36  
What is the fourth term in the expansion of  $(y - 1)^7$ ?

[A]  $35y^3$       [B]  $-35y^4$   
[C]  $-35y^3$       [D]  $35y^4$

26. 060807b, P.I. A2.A.34  
Which expression represents the sum of the sequence 3, 5, 7, 9, 11?

[A]  $\sum_{n=1}^5 (2n + 1)$       [B]  $\sum_{n=0}^5 (2n + 1)$   
[C]  $\sum_{n=1}^5 3n$       [D]  $\sum_{n=1}^5 (3n + 1)$

27. 080827b, P.I. A2.S.7  
The accompanying table shows the number of bacteria present in a certain culture over a 5-hour period, where  $x$  is the time, in hours, and  $y$  is the number of bacteria.

$x$	$y$
0	1,000
1	1,049
2	1,100
3	1,157
4	1,212
5	1,271

Write an exponential regression equation for this set of data, rounding all values to *four decimal places*. Using this equation, determine the number of whole bacteria present when  $x$  equals 6.5 hours.

28. 060211b, P.I. A2.S.8  
A linear regression equation of best fit between a student's attendance and the degree of success in school is  $h = 0.5x + 68.5$ . The correlation coefficient,  $r$ , for these data would be

[A]  $r = 0$       [B]  $0 < r < 1$   
[C]  $-1 < r < 0$       [D]  $r = -1$

29. 080521b, P.I. A2.N.10  
Evaluate:  $\sum_{n=1}^5 (n^2 + n)$

30. 060827b, P.I. A2.S.7

The accompanying table shows the amount of water vapor,  $y$ , that will saturate 1 cubic meter of air at different temperatures,  $x$ .

**Amount of Water Vapor That Will Saturate 1 Cubic Meter of Air at Different Temperatures**

Air Temperature ( $x$ ) (°C)	Water Vapor ( $y$ ) (g)
-20	1
-10	2
0	5
10	9
20	17
30	29
40	50

Write an exponential regression equation for this set of data, rounding all values to the *nearest thousandth*. Using this equation, predict the amount of water vapor that will saturate 1 cubic meter of air at a temperature of 50°C, and round your answer to the *nearest tenth of a gram*.

31. 060134b, P.I. A2.S.7

The 1999 win-loss statistics for the American League East baseball teams on a particular date is shown in the accompanying chart.

	W	L
New York	52	34
Boston	49	39
Toronto	47	43
Tampa Bay	39	49
Baltimore	36	51

Find the mean for the number of wins,  $\bar{W}$ , and the mean for the number of losses,  $\bar{L}$ , and determine if the point  $(\bar{W}, \bar{L})$  is a point on the line of best fit. Justify your answer.

32. fall9934b, P.I. A2.S.7

The volume of a particular gas was determined at various pressures.  $P$  is the pressure (in atmospheres) and is the independent variable on the horizontal axis, and  $V$  is the volume (in liters) and is the dependent variable on the vertical axis: Create a scatter plot and find the equation of the curve of best fit. (Round answer constants to *nearest tenth*) and then, using the regression equation found, estimate  $V$  if  $P = 2.5$ .

P	V
0.1	225
0.3	74.999
0.5	45
0.7	32.139
0.9	25
1.1	20.45
1.5	15
1.7	13.24
1.9	11.84
2.1	10.71
2.3	9.78

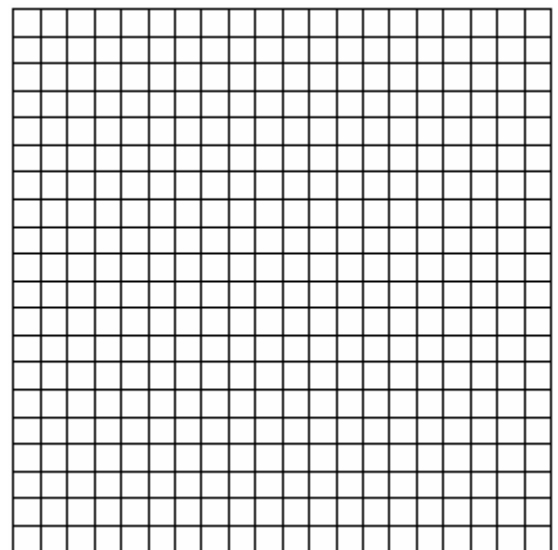



33. 080412b, P.I. A2.A.36  
What is the middle term in the expansion of  $(x + y)^4$ ?

[A]  $4x^2y^2$                       [B]  $6x^2y^2$   
[C]  $x^2y^2$                         [D]  $2x^2y^2$

34. 060729b, P.I. A2.S.4  
Conant High School has 17 students on its championship bowling team. Each student bowled one game. The scores are listed in the accompanying table.

Score ( $x_i$ )	Frequency ( $f_i$ )
140	4
145	3
150	2
160	3
170	2
180	2
194	1

Find, to the *nearest tenth*, the population standard deviation of these scores. How many of the scores fall within one standard deviation of the mean?

35. 060402b, P.I. A2.S.15  
The Hiking Club plans to go camping in a State park where the probability of rain on any given day is 0.7. Which expression can be used to find the probability that it will rain on *exactly* three of the seven days they are there?

[A]  ${}_4C_3(0.4)^4(0.3)^3$     [B]  ${}_7C_3(0.7)^3(0.3)^4$   
[C]  ${}_7C_3(0.3)^3(0.7)^4$     [D]  ${}_4C_3(0.7)^3(0.7)^4$

36. 060201b, P.I. A2.N.10  
What is the value of  $\sum_{m=2}^5 (m^2 - 1)$ ?

[A] 53      [B] 58      [C] 54      [D] 50

37. 080830b, P.I. A2.S.15  
East West Airlines has a good reputation for being on time. The probability that one of its flights will be on time is .91. If Mrs. Williams flies East West for her next five flights, what is the probability that *at least* three of them will be on time? Round your answer to the *nearest thousandth*.

38. 010524b, P.I. A2.S.15  
If the probability that it will rain on any given day this week is 60%, find the probability it will rain *exactly* 3 out of 7 days this week.

39. 080522b, P.I. A2.S.15  
The Coolidge family's favorite television channels are 3, 6, 7, 10, 11, and 13. If the Coolidge family selects a favorite channel at random to view each night, what is the probability that they choose *exactly* three even-numbered channels in five nights? Express your answer as a fraction or as a decimal rounded to *four decimal places*.

40. 010730b, P.I. A2.S.7  
The accompanying table shows the number of new cases reported by the Nassau and Suffolk County Police Crime Stoppers program for the years 2000 through 2002.

Year ( $x$ )	New Cases ( $y$ )
2000	457
2001	369
2002	353

If  $x = 1$  represents the year 2000, and  $y$  represents the number of new cases, find the equation of best fit using a power regression, rounding all values to the *nearest thousandth*. Using this equation, find the estimated number of new cases, to the *nearest whole number*, for the year 2007.

41. 010903b, P.I. A2.S.15  
If the probability that the Islanders will beat the Rangers in a game is  $\frac{2}{5}$ , which expression represents the probability that the Islanders will win *exactly* four out of seven games in a series against the Rangers?

[A]  ${}_7C_4\left(\frac{2}{5}\right)^4\left(\frac{3}{5}\right)^3$       [B]  ${}_7C_4\left(\frac{2}{5}\right)^4\left(\frac{2}{5}\right)^3$   
[C]  ${}_5C_2\left(\frac{4}{7}\right)^2\left(\frac{3}{7}\right)^3$       [D]  $\left(\frac{2}{5}\right)^4\left(\frac{3}{5}\right)^3$

42. 060117b, P.I. A2.N.10  
What is the value of  $\sum_{m=1}^3 (2m+1)^{m-1}$  ?

[A] 57      [B] 15      [C] 245      [D] 55

43. 080202b, P.I. A2.S.5  
In a New York City high school, a survey revealed the mean amount of cola consumed each week was 12 bottles and the standard deviation was 2.8 bottles. Assuming the survey represents a normal distribution, how many bottles of cola per week will approximately 68.2% of the students drink?

[A] 6.4 to 12      [B] 9.2 to 14.8  
[C] 6.4 to 17.6      [D] 12 to 20.4

44. 080418b, P.I. A2.A.35  
A ball is dropped from a height of 8 feet and allowed to bounce. Each time the ball bounces, it bounces back to half its previous height. The vertical distance the ball travels,  $d$ , is given by the formula  $d = 8 + 16\sum_{k=1}^n \left(\frac{1}{2}\right)^k$ , where  $n$  is the number of bounces. Based on this formula, what is the total vertical distance that the ball has traveled after four bounces?

[A] 15.0 ft      [B] 8.9 ft  
[C] 22.0 ft      [D] 23.0 ft

45. 080808b, P.I. A2.A.52  
The family of curves shown in the accompanying graph illustrates the transformations of a function.

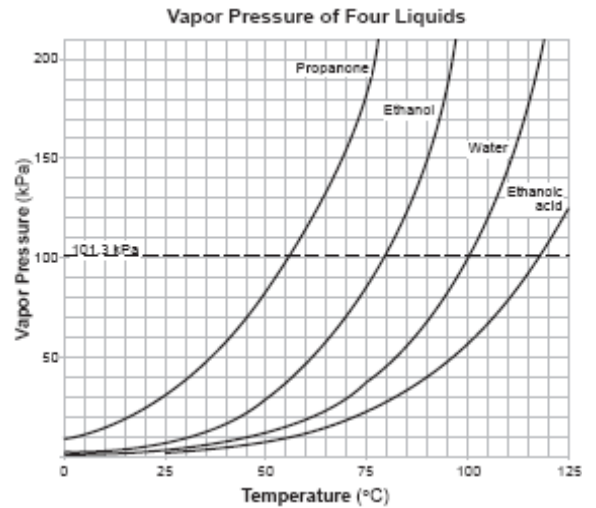

Which type of function could be the original function?

- [A] sinusoidal      [B] tangent  
[C] linear      [D] exponential

46. 080429b, P.I. A2.S.7  
A box containing 1,000 coins is shaken, and the coins are emptied onto a table. Only the coins that land heads up are returned to the box, and then the process is repeated. The accompanying table shows the number of trials and the number of coins returned to the box after each trial.

Trial	0	1	3	4	6
Coins Returned	1,000	610	220	132	45

Write an exponential regression equation, rounding the calculated values to the *nearest ten-thousandth*. Use the equation to predict how many coins would be returned to the box after the eighth trial.

47. 060625b, P.I. A2.S.15

Ginger and Mary Anne are planning a vacation trip to the island of Capri, where the probability of rain on any day is 0.3. What is the probability that during their five days on the island, they have *no* rain on *exactly* three of the five days?

48. fall9918b, P.I. A2.S.15

A fair coin is tossed 5 times. What is the probability that it lands tails up *exactly* 3 times?

- [A]  $10\left(\frac{1}{2}\right)^5$                       [B]  $\frac{3}{5}$   
[C]  $\left(\frac{1}{2}\right)^3$                               [D]  $10\left(\frac{1}{2}\right)^3$

49. 010633b, P.I. A2.S.7

Since 1990, fireworks usage nationwide has grown, as shown in the accompanying table, where  $t$  represents the number of years since 1990, and  $p$  represents the fireworks usage per year, in millions of pounds.

Number of Years Since 1990 ( $t$ )	Fireworks Usage per Year, In Millions of Pounds ( $p$ )
0	67.6
2	88.8
4	119.0
6	120.1
7	132.5
8	118.3
9	159.2
11	161.6

Find the equation of the linear regression model for this set of data, where  $t$  is the independent variable. Round values to *four decimal places*. Using this equation, determine in what year fireworks usage would have reached 99 million pounds. Based on this linear model, how many millions of pounds of fireworks would be used in the year 2008? Round your answer to the *nearest tenth*.

50. 060223b, P.I. A2.S.15

After studying a couple's family history, a doctor determines that the probability of any child born to this couple having a gene for disease  $X$  is 1 out of 4. If the couple has three children, what is the probability that *exactly* two of the children have the gene for disease  $X$ ?

51. 080221b, P.I. A.A.9

A used car was purchased in July 1999 for \$11,900. If the car depreciates 13% of its value each year, what is the value of the car, to the *nearest hundred dollars*, in July 2002?

52. 080114b, P.I. A.A.7

A cellular telephone company has two plans. Plan  $A$  charges \$11 a month and \$0.21 per minute. Plan  $B$  charges \$20 a month and \$0.10 per minute. After how much time, to the *nearest minute*, will the cost of plan  $A$  be equal to the cost of plan  $B$ ?

- [A] 81 hr 48 min                      [B] 1 hr 22 m  
[C] 1 hr 36 min                      [D] 81 hr 8 min

53. 060507b, P.I. A2.S.3

What is the mean of the data in the accompanying table?

Scores ( $x_i$ )	Frequency ( $f_i$ )
25	3
20	2
11	5
10	4

- [A] 14.5    [B] 15    [C] 16    [D] 11

54. 010304b, P.I. A2.N.10

What is the value of  $\sum_{b=0}^3 (2 - (b)i)$  ?

- [A]  $8-5i$     [B]  $8-6i$     [C]  $2-6i$     [D]  $2-5i$

55. 010504b, P.I. A2.A.39  
What is the domain of the function

$$f(x) = \frac{3x^2}{x^2 - 49}$$

- [A]  $\{x \mid x \in \text{real numbers}, x \neq \pm 7\}$   
 [B]  $\{x \mid x \in \text{real numbers}\}$   
 [C]  $\{x \mid x \in \text{real numbers}, x \neq 0\}$   
 [D]  $\{x \mid x \in \text{real numbers}, x \neq 7\}$
56. 060804b, P.I. A2.A.51  
The accompanying graph shows the elevation of a certain region in New York State as a hiker travels along a trail.

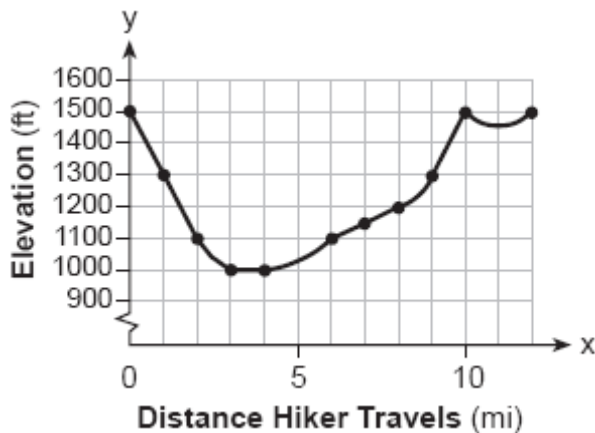

What is the domain of this function?

- [A]  $1,000 \leq y \leq 1,500$   
 [B]  $1,000 \leq x \leq 1,500$   
 [C]  $0 \leq y \leq 12$       [D]  $0 \leq x \leq 12$
57. 080430b, P.I. A2.S.15  
Tim Parker, a star baseball player, hits one home run for every ten times he is at bat. If Parker goes to bat five times during tonight's game, what is the probability that he will hit *at least* four home runs?

58. 080630b, P.I. A2.S.15  
On mornings when school is in session in January, Sara notices that her school bus is late one-third of the time. What is the probability that during a 5-day school week in January her bus will be late *at least* three times?

59. 010229b, P.I. A2.S.15  
Team A and team B are playing in a league. They will play each other five times. If the probability that team A wins a game is  $\frac{1}{3}$ , what is the probability that team A will win *at least* three of the five games?

60. 010918b, P.I. A2.A.51  
The accompanying graph illustrates the presence of a certain strain of bacteria at various pH levels.

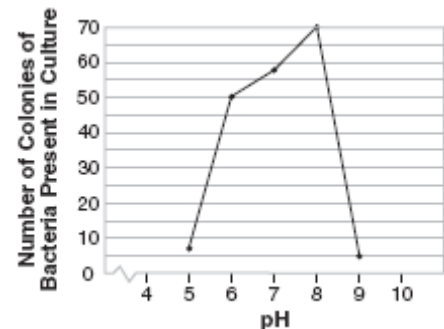

What is the range of this set of data?

- [A]  $5 \leq x \leq 9$       [B]  $5 \leq y \leq 70$   
 [C]  $0 \leq y \leq 70$       [D]  $5 \leq x \leq 70$
61. 010314b, P.I. A2.A.39  
If  $f(x) = \frac{1}{\sqrt{2x-4}}$ , the domain of  $f(x)$  is
- [A]  $x \geq 2$       [B]  $x = 2$   
 [C]  $x < 2$       [D]  $x > 2$

62. 080515b, P.I. A2.S.5

The mean score on a normally distributed exam is 42 with a standard deviation of 12.1. Which score would be expected to occur less than 5% of the time?

- [A] 67    [B] 32    [C] 25    [D] 60

63. 060631b, P.I. A2.S.7

A factory is producing and stockpiling metal sheets to be shipped to an automobile manufacturing plant. The factory ships only when there is a minimum of 2,050 sheets in stock. The accompanying table shows the day,  $x$ , and the number of sheets in stock,  $f(x)$ .

Day ( $x$ )	Sheets in Stock ( $f(x)$ )
1	860
2	930
3	1000
4	1150
5	1200
6	1360

Write the linear regression equation for this set of data, rounding the coefficients to *four decimal places*. Use this equation to determine the day the sheets will be shipped.

64. 060624b, P.I. A2.N.10

Evaluate:  $\sum_{k=1}^2 \frac{(-1)^{k-1}}{(2k-1)!}$

65. 010302b, P.I. A2.S.15

The probability that Kyla will score above a 90 on a mathematics test is  $\frac{4}{5}$ . What is the probability that she will score above a 90 on three of the four tests this quarter?

- [A]  $\frac{3}{4}\left(\frac{4}{5}\right)^1\left(\frac{1}{5}\right)^3$     [B]  ${}_4C_3\left(\frac{4}{5}\right)^3\left(\frac{1}{5}\right)^1$   
 [C]  ${}_4C_3\left(\frac{4}{5}\right)^1\left(\frac{1}{5}\right)^3$     [D]  $\frac{3}{4}\left(\frac{4}{5}\right)^3\left(\frac{1}{5}\right)^1$

66. 010602b, P.I. A2.A.51

The effect of pH on the action of a certain enzyme is shown on the accompanying graph.

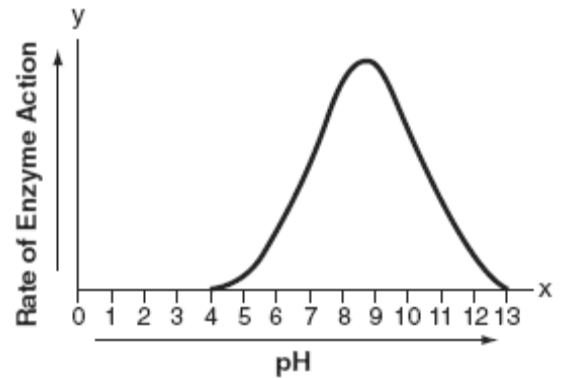

What is the domain of this function?

- [A]  $x \geq 0$                       [B]  $4 \leq x \leq 13$   
 [C]  $y \geq 0$                       [D]  $4 \leq y \leq 13$

67. fall9910b, P.I. A2.S.8

The points in the scatter plot below represent the ages of automobiles and their values. Based on this scatter plot, it would be reasonable to conclude:



- [A] Age and value have a coefficient of correlation that is between zero and 0.5.  
 [B] Age and value have a coefficient of correlation that is equal to zero.  
 [C] Age and value have a coefficient of correlation that is less than zero.  
 [D] Age and value have a coefficient of correlation that is greater than 0.5.

68. 080213b, P.I. A2.N.10  
If  ${}_n C_r$  represents the number of combinations of  $n$  items taken  $r$  at a time, what is the value of  $\sum_{r=1}^3 {}_4 C_r$ ?

[A] 14    [B] 4    [C] 6    [D] 24

69. 080708b, P.I. A2.A.51  
A meteorologist drew the accompanying graph to show the changes in relative humidity during a 24-hour period in New York City.

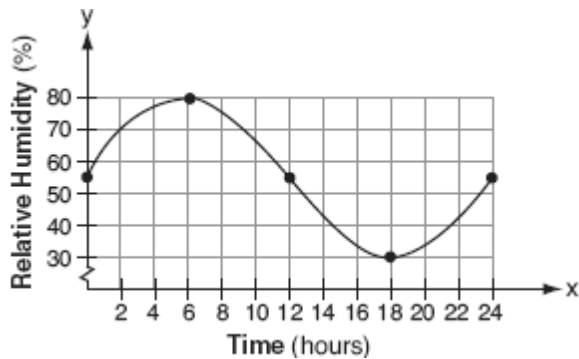

What is the range of this set of data?

- [A]  $0 \leq x \leq 24$     [B]  $0 \leq y \leq 24$   
[C]  $30 \leq x \leq 80$     [D]  $30 \leq y \leq 80$

70. 060221b  
On a nationwide examination, the Adams School had a mean score of 875 and a standard deviation of 12. The Boswell School had a mean score of 855 and a standard deviation of 20. In which school was there greater consistency in the scores? Explain how you arrived at your answer.

71. 060326b, P.I. A2.A.35  
Evaluate:  $2 \sum_{n=1}^5 (2n - 1)$

72. 080823b, P.I. A2.N.10  
Evaluate:  $3 \sum_{x=2}^4 (x^2 - 5)$

73. 060830b, P.I. A2.S.15  
The probability of rain on the last day of July is 90%. If the probability remains constant for the first seven days of August, what is the probability that it will rain *at least* six of those seven days in August?

74. 060334b, P.I. G.G.74  
For a carnival game, John is painting two circles,  $V$  and  $M$ , on a square dartboard. a On the accompanying grid, draw and label circle  $V$ , represented by the equation  $x^2 + y^2 = 25$ , and circle  $M$ , represented by the equation  $(x - 8)^2 + (y + 6)^2 = 4$ .

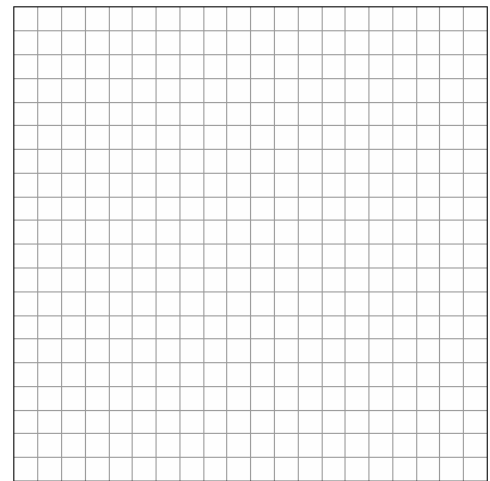

b A point,  $(x,y)$ , is randomly selected such that  $-10 \leq x \leq 10$  and  $-10 \leq y \leq 10$ . What is the probability that point  $(x,y)$  lies outside both circle  $V$  and circle  $M$ ?

75. 060109b, P.I. A2.S.8  
The relationship of a woman's shoe size and length of a woman's foot, in inches, is given in the accompanying table.

Woman's Shoe Size	5	6	7	8
Foot Length (in)	9.00	9.25	9.50	9.75

The linear correlation coefficient for this relationship is

- [A] -1    [B] 1    [C] 0.5    [D] 0

76. 010530b, P.I. A2.S.7

A real estate agent plans to compare the price of a cottage,  $y$ , in a town on the seashore to the number of blocks,  $x$ , the cottage is from the beach. The accompanying table shows a random sample of sales and location data. Write a linear regression equation that relates the price of a cottage to its distance from the beach. Use the equation to predict the price of a cottage, to the *nearest dollar*, located three blocks from the beach.

Number of Blocks from the Beach ( $x$ )	Price of a Cottage ( $y$ )
5	\$132,000
0	\$310,000
4	\$204,000
2	\$238,000
1	\$275,000
7	\$60,800

77. 060714b, P.I. A2.N.10

The expression  $1 + \sqrt{2} + \sqrt[3]{3}$  is equivalent to

- [A]  $\sum_{n=0}^3 n^n$                       [B]  $\sum_{n=1}^3 n^{-n}$   
 [C]  $\sum_{n=1}^3 \sqrt{n}$                       [D]  $\sum_{n=1}^3 n^{\frac{1}{n}}$

78. 060407b, P.I. A2.A.39

What is the domain of the function

$$f(x) = \frac{2x^2}{x^2 - 9}?$$

- [A] all real numbers except 0  
 [B] all real numbers except 3  
 [C] all real numbers except 3 and -3  
 [D] all real numbers

79. 010226b, P.I. A2.S.5

A set of normally distributed student test scores has a mean of 80 and a standard deviation of 4. Determine the probability that a randomly selected score will be between 74 and 82.

80. 080331b, P.I. A2.S.7

The table below shows the results of an experiment that relates the height at which a ball is dropped,  $x$ , to the height of its first bounce,  $y$ .

Drop Height ( $x$ ) (cm)	Bounce Height ( $y$ ) (cm)
100	26
90	23
80	21
70	18
60	16

Find  $\bar{x}$ , the mean of the drop heights. Find  $\bar{y}$ , the mean of the bounce heights. Find the linear regression equation that best fits the data. Show that  $(\bar{x}, \bar{y})$  is a point on the line of regression. [The use of the grid is optional.]

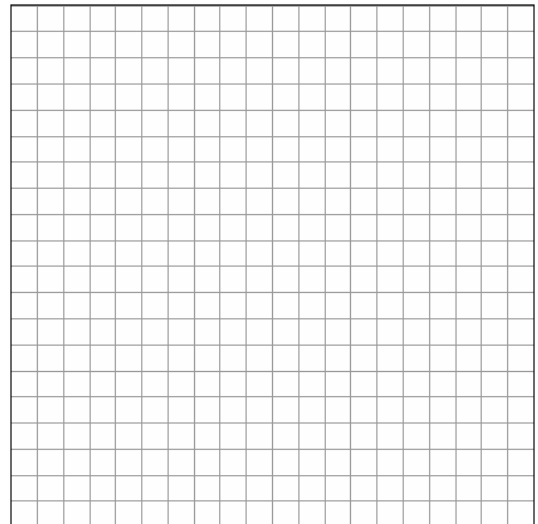

81. 080106b, P.I. A2.A.2

The roots of the equation  $x^2 - 3x - 2 = 0$  are

- [A] real, rational, and unequal  
 [B] real, rational, and equal  
 [C] real, irrational, and unequal  
 [D] imaginary

82. 080631b, P.I. A2.S.7

Jean invested \$380 in stocks. Over the next 5 years, the value of her investment grew, as shown in the accompanying table.

Years Since Investment ( $x$ )	Value of Stock, in Dollars ( $y$ )
0	380
1	395
2	411
3	427
4	445
5	462

Write the exponential regression equation for this set of data, rounding all values to *two decimal places*. Using this equation, find the value of her stock, to the *nearest dollar*, 10 years after her initial purchase.

83. 010428b, P.I. A2.S.15

A board game has a spinner on a circle that has five equal sectors, numbered 1, 2, 3, 4, and 5, respectively. If a player has four spins, find the probability that the player spins an even number *no more than* two times on those four spins.

84. 010433b, P.I. A2.S.7

The accompanying table shows the average salary of baseball players since 1984. Using the data in the table, create a scatter plot on the grid and state the exponential regression equation with the coefficient and base rounded to the *nearest hundredth*. Using your written regression equation, estimate the salary of a baseball player in the year 2005, to the *nearest thousand dollars*.

Baseball Players' Salaries

Numbers of Years Since 1984	Average Salary (thousands of dollars)
0	290
1	320
2	400
3	495
4	600
5	700
6	820
7	1,000
8	1,250
9	1,580

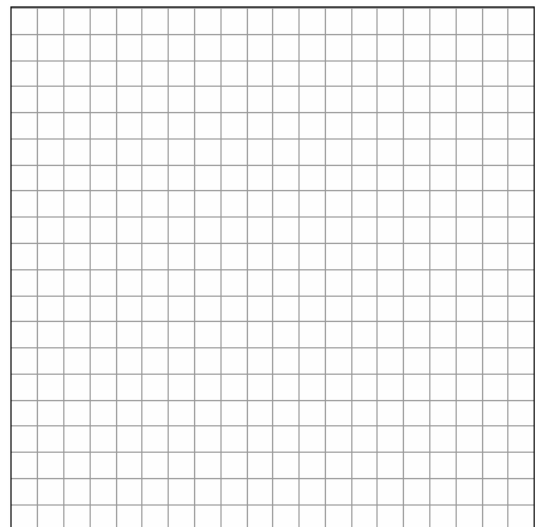



85. 010807b, P.I. A2.S.3

Mayken collected data about the size of the honors classes in her school building. This set of data is shown in the accompanying table.

Class Size	Frequency
8	1
10	3
14	2

Which statement about the range of this sample is true?

- [A] range < mean  
 [B] range < standard deviation  
 [C] range = mean      [D] range > mean

86. 010327b, P.I. A2.S.5

A shoe manufacturer collected data regarding men's shoe sizes and found that the distribution of sizes exactly fits the normal curve. If the mean shoe size is 11 and the standard deviation is 1.5, find:

- a* the probability that a man's shoe size is greater than or equal to 11  
*b* the probability that a man's shoe size is greater than or equal to 12.5

*c*  $\frac{P(\text{size} \geq 12.5)}{P(\text{size} \geq 8)}$

87. 060529b, P.I. A2.S.15

The probability that a planted watermelon seed will sprout is  $\frac{3}{4}$ . If Peyton plants seven seeds from a slice of watermelon, find, to the nearest ten thousandth, the probability that at least five will sprout.

88. 010731b, P.I. A2.S.15

Dr. Glendon, the school physician in charge of giving sports physicals, has compiled his information and has determined that the probability a student will be on a team is 0.39. Yesterday, Dr. Glendon examined five students chosen at random. Find, to the nearest hundredth, the probability that at least four of the five students will be on a team. Find, to the nearest hundredth, the probability that exactly one of the five students will not be on a team.

89. 080208b, P.I. A2.A.36

What is the last term in the expansion of  $(x + 2y)^5$ ?

- [A]  $10y^5$     [B]  $2y^5$     [C]  $32y^5$     [D]  $y^5$

90. 060702b, P.I. A2.S.15

During a single day at radio station WMZH, the probability that a particular song is played is .38. Which expression represents the probability that this song will be played on exactly 5 days out of 7 days?

- [A]  ${}_7C_5(.38)^2(.62)^5$     [B]  ${}_5C_2(.38)^5(.62)^2$   
 [C]  ${}_7P_5(.38)^5(.62)^2$     [D]  ${}_7C_5(.38)^5(.62)^2$

91. 010933b, P.I. A2.S.7

The accompanying table shows wind speed and the corresponding wind chill factor when the air temperature is 10°F.

Wind Speed (mi/h) $x$	Wind Chill Factor (°F) $y$
4	3
5	1
12	-5
16	-7
22	-10
31	-12

Write the logarithmic regression equation for this set of data, rounding coefficients to the *nearest ten thousandth*. Using this equation, find the wind chill factor, to the *nearest degree*, when the wind speed is 50 miles per hour. Based on your equation, if the wind chill factor is 0°, what is the wind speed, to the *nearest mile per hour*?

92. 060523b, P.I. A2.N.10

Evaluate:  $\sum_{k=0}^3 (3\cos k\pi + 1)$

93. 060206b, P.I. A2.S.5

On a standardized test, the distribution of scores is normal, the mean of the scores is 75, and the standard deviation is 5.8. If a student scored 83, the student's score ranks

- [A] above the 97th percentile
- [B] below the 75th percentile
- [C] between the 84th percentile and the 97th percentile
- [D] between the 75th percentile and the 84th percentile

94. 080728b, P.I. A2.S.7

The accompanying table shows the percent of the adult population that married before age 25 in several different years. Using the year as the independent variable, find the linear regression equation. Round the regression coefficients to the *nearest hundredth*. Using the equation found above, estimate the percent of the adult population in the year 2009 that will marry before age 25, and round to the *nearest tenth of a percent*.

Year ( $x$ )	Percent ( $y$ )
1971	42.4
1976	37.4
1980	37.1
1984	34.1
1989	32.1
1993	28.8
1997	25.7
2000	25.5

95. 060501b, P.I. A2.A.51

The accompanying graph shows the heart rate, in beats per minute, of a jogger during a 4-minute interval.

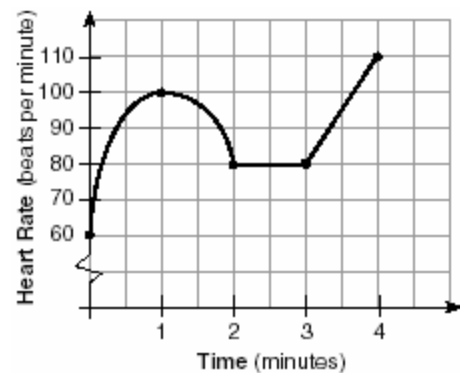

What is the range of the jogger's heart rate during this interval?

- [A] 1-4
- [B] 60-110
- [C] 0-110
- [D] 0-4

96. 010411b, P.I. A2.S.5

Battery lifetime is normally distributed for large samples. The mean lifetime is 500 days and the standard deviation is 61 days.

Approximately what percent of batteries have lifetimes *longer than* 561 days?

[A] 84%    [B] 34%    [C] 68%    [D] 16%

97. 060421b, P.I. A2.A.35

The projected total annual profits, in dollars, for the Nutyme Clothing Company from 2002 to 2004 can be approximated by the model

$\sum_{n=0}^2 (13,567n + 294)$ , where  $n$  is the year and

$n = 0$  represents 2002. Use this model to find the company's projected total annual profits, in dollars, for the period 2002 to 2004.

98. 080201b, P.I. A2.S.15

Which fraction represents the probability of obtaining *exactly* eight heads in ten tosses of a fair coin?

[A]  $\frac{180}{1,024}$                       [B]  $\frac{90}{1,024}$

[C]  $\frac{64}{1,024}$                       [D]  $\frac{45}{1,024}$

99. 010922b, P.I. A2.N.10

Evaluate:  $\sum_{n=1}^3 \left( \sin \frac{n\pi}{2} \right)$

1. 080203b, P.I. A2.A.1

What is the solution of the inequality

$$|x + 3| \leq 5?$$

[A]  $x \leq -2$  or  $x \geq 8$       [B]  $-2 \leq x \leq 8$

[C]  $x \leq -8$  or  $x \geq 2$       [D]  $-8 \leq x \leq 2$

2. 010802b, P.I. A2.A.22

What is the value of  $x$  in the equation

$$\sqrt{3+x} - 5 = -2?$$

[A] 6      [B] 12      [C] 3      [D] 46

3. 060526b, P.I. A2.A.42

A certain drug raises a patient's heart rate,  $h(x)$ , in beats per minute, according to the function  $h(x) = 70 + 0.2x$ , where  $x$  is the bloodstream drug level, in milligrams. The level of the drug in the patient's bloodstream is a function of time,  $t$ , in hours, according to the formula  $g(t) = 300(0.8)^t$ . Find the value of  $h(g(4))$ , the patient's heart rate in beats per minute, to the *nearest whole number*.

4. 080319b, P.I. A2.A.44

A function is defined by the equation

$$y = \frac{1}{2}x - \frac{3}{2}. \text{ Which equation defines the}$$

inverse of this function?

[A]  $y = 2x + 3$       [B]  $y = 2x + \frac{3}{2}$

[C]  $y = 2x - 3$       [D]  $y = 2x - \frac{3}{2}$

5. 080819b, P.I. A2.A.27

If  $2^{(16x^2 - 8x - 3)} = 1$ , what does  $x$  equal?

[A]  $-\frac{1}{4}$  and  $\frac{3}{4}$       [B]  $\frac{1}{4}$  and  $-\frac{3}{4}$

[C]  $\frac{1}{4}$ , only      [D]  $\frac{3}{4}$ , only

6. 060604b, P.I. A2.A.77

If  $x$  is a positive acute angle and  $\sin x = \frac{1}{2}$ ,

what is  $\sin 2x$ ?

[A]  $\frac{1}{2}$       [B]  $-\frac{\sqrt{3}}{2}$       [C]  $\frac{\sqrt{3}}{2}$       [D]  $-\frac{1}{2}$

7. fall9901b, P.I. A2.A.52

The graph below represents the relationship of transported particle size to water velocity. The graph best models which type of function?

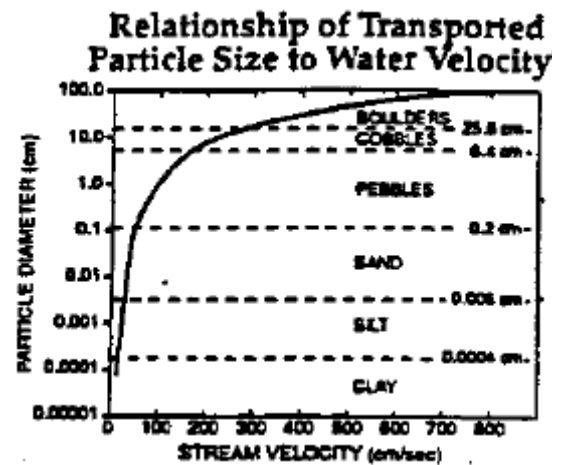

[A] linear

[B] trigonometric

[C] quadratic

[D] logarithmic

8. 010813b, P.I. A.A.9

A radioactive substance has an initial mass of 100 grams and its mass halves every 4 years. Which expression shows the number of grams remaining after  $t$  years?

[A]  $100(4)^{\frac{t}{4}}$       [B]  $100(4)^{-2t}$

[C]  $100(\frac{1}{2})^{\frac{t}{4}}$       [D]  $100(\frac{1}{2})^{4t}$

9. 060812b

The expression  $\cos^2 4\theta + \sin^2 4\theta$  is equivalent to

[A] 2      [B]  $\cos \theta$       [C]  $\cos 8\theta$       [D] 1

10. 060831b, P.I. G.G.58  
The engineering office in the village of Whitesboro has a map of the village that is laid out on a rectangular coordinate system. A traffic circle located on the map is represented by the equation  $(x + 4)^2 + (y - 2)^2 = 81$ . The village planning commission asks that the transformation  $D_2$  be applied to produce a new traffic circle, where the center of dilation is at the origin. Find the coordinates of the center of the new traffic circle. Find the length of the radius of the new traffic circle.

11. 060222b, P.I. A2.A.66

Is  $\frac{1}{2}\sin 2x$  the same expression as  $\sin x$ ?

Justify your answer.

12. 080818b, P.I. A2.A.23

One root of the equation  $\frac{3x}{2} + \frac{1}{x} = -\frac{3x}{4}$  is

- [A]  $\frac{4i}{9}$     [B]  $\frac{2}{3}$     [C]  $\frac{4}{9}$     [D]  $\frac{2i}{3}$

13. 010713b, P.I. A2.A.2

Which is a true statement about the graph of the equation  $y = x^2 - 7x - 60$ ?

- [A] It intersects the  $x$ -axis in two distinct points that have rational coordinates.  
[B] It does not intersect the  $x$ -axis.  
[C] It intersects the  $x$ -axis in two distinct points that have irrational coordinates.  
[D] It is tangent to the  $x$ -axis.

14. 010305b, P.I. A2.A.22

What is the solution set of the equation

$$\sqrt{9x + 10} = x$$

- [A] {10}                      [B] {9}  
[C] {-1}                      [D] {10, -1}

15. 010812b, P.I. A2.A.42

The accompanying tables define functions  $f$  and  $g$ .

$x$	1	2	3	4	5
$f(x)$	3	4	5	6	7

$x$	3	4	5	6	7
$g(x)$	4	6	8	10	12

What is  $(g \circ f)(3)$ ?

- [A] 8    [B] 6    [C] 4    [D] 2

16. 010404b, P.I. A2.A.27

What is a positive value of  $x$  for which

$$9^{-\cos x} = \frac{1}{3}?$$

- [A]  $45^\circ$     [B]  $60^\circ$     [C]  $30^\circ$     [D]  $90^\circ$

17. 010630b, P.I. A2.A.68

An architect is using a computer program to design the entrance of a railroad tunnel. The outline of the opening is modeled by the function  $f(x) = 8\sin x + 2$ , in the interval  $0 \leq x \leq \pi$ , where  $x$  is expressed in radians. Solve algebraically for all values of  $x$  in the interval  $0 \leq x \leq \pi$ , where the height of the opening,  $f(x)$ , is 6. Express your answer in terms of  $\pi$ . If the  $x$ -axis represents the base of the tunnel, what is the maximum height of the entrance of the tunnel?

18. 080427b, P.I. A2.A.1

A depth finder shows that the water in a certain place is 620 feet deep. The difference between  $d$ , the actual depth of the water, and the reading is  $|d - 620|$  and must be less than or equal to  $0.05d$ . Find the minimum and maximum values of  $d$ , to the nearest tenth of a foot.

19. 080130b, P.I. A.G.1  
A small, open-top packing box, similar to a shoebox without a lid, is three times as long as it is wide, and half as high as it is long. Each square inch of the bottom of the box costs \$0.008 to produce, while each square inch of any side costs \$0.003 to produce. Write a function for the cost of the box described above. Using this function, determine the dimensions of a box that would cost \$0.69 to produce.

20. 060115b, P.I. A2.A.44  
The inverse of a function is a logarithmic function in the form  $y = \log_b x$ . Which equation represents the original function?

- [A]  $y = b^x$                       [B]  $y = bx$   
[C]  $x = b^y$                       [D]  $by = x$

21. 010420b, P.I.A2.A.52  
The cells of a particular organism increase logarithmically. If  $g$  represents cell growth and  $h$  represents time, in hours, which graph best represents the growth pattern of the cells of this organism?

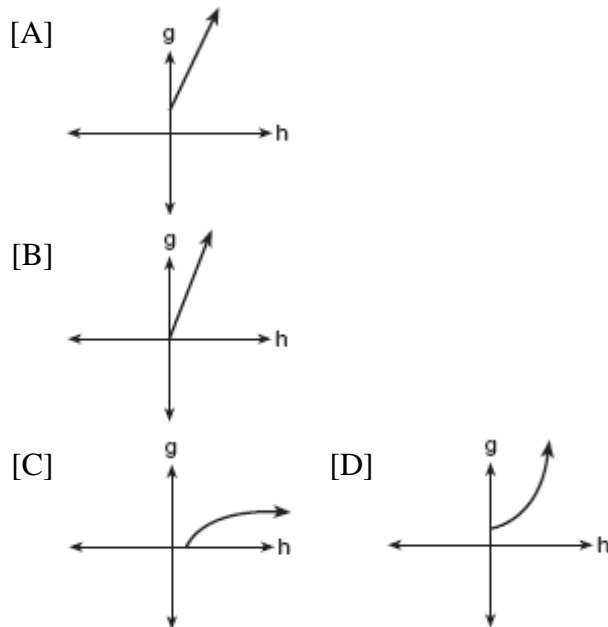

22. 010211b, P.I. A2.A.38  
Which relation is a function?  
[A]  $x = 4$                       [B]  $x^2 + y^2 = 16$   
[C]  $y = \sin x$                 [D]  $x = y^2 + 1$

23. 080722b, P.I. A.A.26  
Solve for all values of  $x$ :  $\frac{2}{x+1} = x$

24. 080822b, A2.A.1  
Solve for all values of  $x$ :  $|3x - 2| = 6$

25. 060417b, P.I. A2.A.42  
If  $f(x) = x + 1$  and  $g(x) = x^2 - 1$ , the expression  $(g \circ f)(x)$  equals 0 when  $x$  is equal to  
[A] 0, only                      [B] -2, only  
[C] 1 and -1                    [D] 0 and -2

26. 080529b, P.I. A2.A.23  
Solve for all values of  $x$ :  $\frac{9}{x} + \frac{9}{x-2} = 12$

27. 060629b, P.I. A2.A.22  
Solve algebraically for  $x$ :  $\sqrt{3x+1} + 1 = x$

28. 060131b, P.I. A2.A.68  
In the interval  $0^\circ \leq A \leq 360^\circ$ , solve for all values of  $A$  in the equation  $\cos 2A = -3 \sin A - 1$ .

29. 060515b  
A crate weighing  $w$  pounds sits on a ramp positioned at an angle of  $\theta$  with the horizontal. The forces acting on this crate are modeled by the equation  $Mw \cos \theta = w \sin \theta$ , where  $M$  is the coefficient of friction. What is an expression for  $M$  in terms of  $\theta$ ?

- [A]  $M = \cot \theta$                 [B]  $M = \tan \theta$   
[C]  $M = \csc \theta$                 [D]  $M = \sec \theta$

30. 080720b, P.I. A2.A.28  
If  $\log_2 a = \log_3 a$ , what is the value of  $a$ ?  
[A] 4 [B] 1 [C] 2 [D] 3

31. 080302b, P.I. A2.A.22  
What is the value of  $x$  in the equation  $\sqrt{5-2x} = 3i$ ?  
[A] 4 [B] -2 [C] 1 [D] 7

32. 080416b, P.I. A2.A.44  
What is the inverse of the function  $y = \log_4 x$ ?  
[A]  $y^4 = x$  [B]  $x^4 = y$   
[C]  $4^x = y$  [D]  $4^y = x$

33. 080423b  
Solve for  $x$ :  $x^{-3} = \frac{27}{64}$

34. 060105b, P.I. A2.A.69  
A modulated laser heats a diamond. Its variable temperature, in degrees Celsius, is given by  $f(t) = T \sin at$ . What is the period of the curve?  
[A]  $\frac{1}{a}$  [B]  $\frac{2a\pi}{a}$  [C]  $|T|$  [D]  $\frac{2\pi}{a}$

35. 010710b, P.I. A2.A.1  
What is the solution set of the inequality  $|2x - 1| < 9$ ?  
[A]  $\{x|x < -4 \text{ or } x > 5\}$  [B]  $\{x|x < 5\}$   
[C]  $\{x|x < -4\}$  [D]  $\{x|-4 < x < 5\}$

36. 010318b, P.I. A2.A.4  
Which graph represents the solution set of  $x^2 - x - 12 < 0$ ?

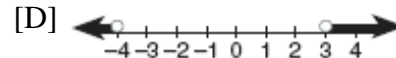
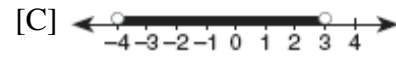
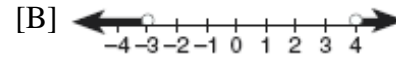
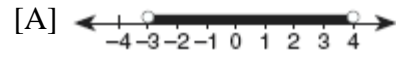

37. 080525b  
Given the function  $y = f(x)$ , such that the entire graph of the function lies above the  $x$ -axis. Explain why the equation  $f(x) = 0$  has no real solutions.

38. fall9925b, P.I. G.G.64  
Given two lines whose equations are  $3x + y - 8 = 0$  and  $-2x + by + 9 = 0$ , determine the value of  $b$  such that the two lines will be perpendicular.

39. 060630b, P.I. A2.S.4  
The number of children of each of the first 41 United States presidents is given in the accompanying table. For this population, determine the mean and the standard deviation to the *nearest tenth*. How many of these presidents fall within one standard deviation of the mean?

Number of Children ( $x_i$ )	Number of Presidents ( $f_i$ )
0	6
1	2
2	8
3	6
4	7
5	3
6	5
7	1
8	1
10	1
15	1

40. 010319b, P.I. A2.A.77

If  $\sin \theta = \frac{\sqrt{5}}{3}$ , then  $\cos 2\theta$  equals

- [A]  $-\frac{1}{3}$  [B]  $\frac{1}{3}$  [C]  $\frac{1}{9}$  [D]  $-\frac{1}{9}$





41. 080516b, P.I. A2.A.2

For which positive value of  $m$  will the equation  $4x^2 + mx + 9 = 0$  have roots that are real, equal, and rational?

- [A] 12 [B] 9 [C] 3 [D] 4

42. 060505b, P.I. A2.A.1

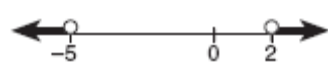
Which graph represents the solution set for the expression  $|2x + 3| > 7$ ?

- [A] 
- [B] 
- [C] 
- [D] 

43. 080632b, P.I. A2.A.27

After an oven is turned on, its temperature,  $T$ , is represented by the equation

$T = 400 - 350(3.2)^{-0.1m}$  where  $m$  represents the number of minutes after the oven is turned on and  $T$  represents the temperature of the oven, in degrees Fahrenheit. How many minutes does it take for the oven's temperature to reach  $300^\circ\text{F}$ ? Round your answer to the nearest minute. [The use of the grid is optional.]

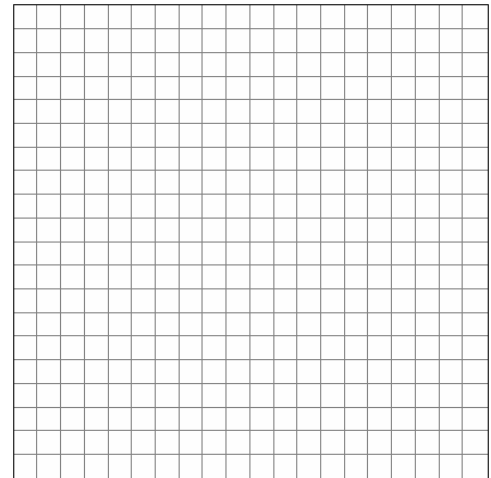

44. 060808b, P.I. A2.A.1

Which value of  $a$  does *not* satisfy the inequality  $|a| > 2a - 3$ ?

- [A] -1 [B] 3 [C] -5 [D] 0

45. 010201b, P.I. A2.A.2

The roots of a quadratic equation are real, rational, and equal when the discriminant is

- [A] 4 [B] -2 [C] 2 [D] 0

46. 010501b, P.I. A2.A.42

If  $f(x) = -2x + 7$  and  $g(x) = x^2 - 2$ , then  $f(g(3))$  is equal to

- [A] -7 [B] -1 [C] -3 [D] 7



47. 080205b, P.I. A2.A.44

A function is defined by the equation  $y = 5x - 5$ . Which equation defines the inverse of this function?

[A]  $x = 5y - 5$       [B]  $x = \frac{1}{5y - 5}$

[C]  $y = \frac{1}{5x - 5}$       [D]  $y = 5x + 5$

48. 010728b, P.I. A2.A.27

Since January 1980, the population of the city of Brownville has grown according to the mathematical model  $y = 720,500(1.022)^x$ , where  $x$  is the number of years since January 1980. Explain what the numbers 720,500 and 1.022 represent in this model. If this trend continues, use this model to predict the year during which the population of Brownville will reach 1,548,800. [The use of the grid is optional.]

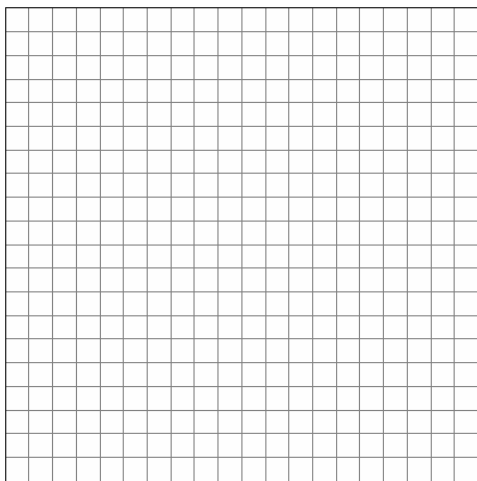

49. 080528b, P.I. A2.A.22

The lateral surface area of a right circular cone,  $s$ , is represented by the equation  $s = \pi r \sqrt{r^2 + h^2}$ , where  $r$  is the radius of the circular base and  $h$  is the height of the cone. If the lateral surface area of a large funnel is 236.64 square centimeters and its radius is 4.75 centimeters, find its height, to the nearest hundredth of a centimeter.

50. 060718b

The formula  $S = 20\sqrt{t + 273}$  is used to determine the speed of sound,  $S$ , in meters per second, near Earth's surface, where  $t$  is the surface temperature, in degrees Celsius. Which graph best represents this function?

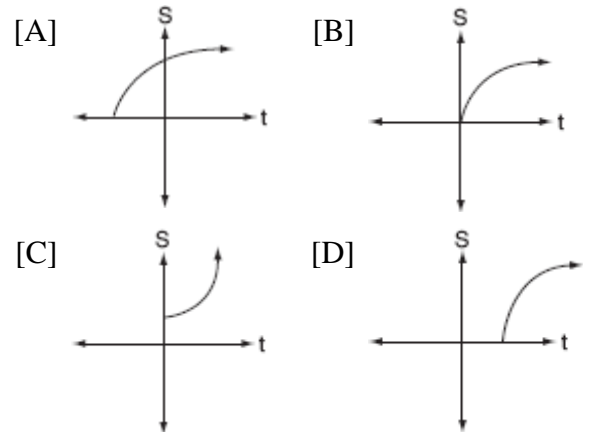

51. 010316b, P.I. A2.A.19

The expression  $\log 10^{x+2} - \log 10^x$  is equivalent to

[A] 2    [B] -2    [C] 100    [D]  $\frac{1}{100}$

52. 010409b, P.I. A2.A.19

If  $\log x = a$ ,  $\log y = b$ , and  $\log z = c$ , then  $\log \frac{x^2 y}{\sqrt{z}}$  is equivalent to

[A]  $2ab - \frac{1}{2}c$       [B]  $2a + b - \frac{1}{2}c$   
[C]  $42a + b + \frac{1}{2}c$       [D]  $a^2 + b - \frac{1}{2}c$

53. 080605b, P.I. A2.A.38

Which equation does *not* represent a function?

[A]  $y = x^2 + 5x$       [B]  $x = \pi$   
[C]  $y = 4$       [D]  $y = |x|$

54. 060212b, P.I. A2.A.23

What is the solution set of the equation

$$\frac{x}{x-4} - \frac{1}{x+3} = \frac{28}{x^2 - x - 12}?$$

- [A] {4,-6} [B] {4} [C] { } [D] {-6}

55. 080303b, P.I. A2.A.1

Which graph represents the solution set of

$$|2x - 1| < 7?$$

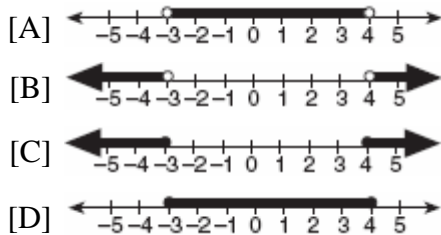

56. 080403b, P.I. A.G.3

Which set of ordered pairs is *not* a function?

- [A] {(3,1), (2,1), (1,2), (3,2)}
- [B] {(4,1), (5,1), (6,1), (7,1)}
- [C] {(0,0), (1,1), (2,2), (3,3)}
- [D] {(1,2), (3,4), (4,5), (5,6)}

57. 080806b, P.I. A2.A.1

Which inequality is represented by the accompanying graph?

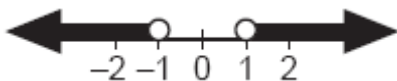

- [A]  $|x| < 1$  [B]  $|x| > 1$
- [C]  $|x| \geq 1$  [D]  $|x| \leq 1$

58. 080821b, P.I. A2.A.22

The number of dogs,  $D$ , housed at a county animal shelter is modeled by the function

$D = 4\sqrt{2M} + 50$ , where  $M$  is the number of months the shelter has been open. How many months will it take for 74 dogs to be housed at the shelter?

59. 060214b, P.I. A2.A.22

What is the solution set of the equation

$$x = 2\sqrt{2x - 3}?$$

- [A] {2} [B] {6} [C] { } [D] {2,6}

60. 060218b, P.I. G.G.54

Which transformation does *not* preserve orientation?

- [A] translation [B] dilation
- [C] rotation [D] reflection in the  $y$ -axis

61. 080813b

The expression  $1 - \sec x$  is equivalent to

- [A]  $\frac{\cos x - 1}{\cos x}$  [B]  $\frac{\sin x - 1}{\sin x}$
- [C]  $\frac{\tan x}{\sec x - 1}$  [D]  $-\tan x$

62. 010202b

Chad had a garden that was in the shape of a rectangle. Its length was twice its width. He decided to make a new garden that was 2 feet longer and 2 feet wider than his first garden. If  $x$  represents the original width of the garden, which expression represents the difference between the area of his new garden and the area of the original garden?

- [A]  $6x + 4$  [B]  $2x^2$
- [C] 8 [D]  $x^2 + 3x + 2$

63. 060318b, P.I. A2.A.1

What is the solution set of the inequality

$$|3 - 2x| \geq 4?$$

- [A]  $\{x|x \leq \frac{7}{2} \text{ or } x \geq \frac{1}{2}\}$
- [B]  $\{x|\frac{7}{2} \leq x \leq -\frac{1}{2}\}$  [C]  $\{x|-\frac{1}{2} \leq x \leq \frac{7}{2}\}$
- [D]  $\{x|x \leq -\frac{1}{2} \text{ or } x \geq \frac{7}{2}\}$

64. fall9923b, P.I. A2.A.22

The period of a pendulum ( $T$ ), in seconds, is the length of time it takes for the pendulum to make one complete swing back and forth.

The formula  $T = 2\pi\sqrt{\frac{L}{32}}$  gives the period  $T$

for a pendulum of length  $L$  in feet. If you want to build a grandfather clock with a pendulum that swings back and forth once every 3 seconds, how long, to the *nearest tenth of a foot*, would you make the pendulum?

65. 010719b, P.I. G.G.61

Which transformation represents a dilation?

- [A]  $(8,4) \rightarrow (-4,-8)$     [B]  $(8,4) \rightarrow (-8,4)$   
[C]  $(8,4) \rightarrow (11,7)$     [D]  $(8,4) \rightarrow (4,2)$

66. 010323b, P.I. A2.A.22

A wrecking ball suspended from a chain is a type of pendulum. The relationship between the rate of speed of the ball,  $R$ , the mass of the ball,  $m$ , the length of the chain,  $L$ , and the

force,  $F$ , is  $R = 2\pi\sqrt{\frac{mL}{F}}$ . Determine the

force,  $F$ , to the *nearest hundredth*, when  $L = 12$ ,  $m = 50$ , and  $R = 0.6$ .

67. 010925b, P.I. A2.A.1

What is the solution of the inequality

$$|2x - 5| \leq 11?$$

68. 010610b, P.I. A2.A.1

What is the solution of the inequality

$$|y + 8| > 3?$$

- [A]  $-5 < y < 11$     [B]  $y > -5$   
[C]  $y > -5$  or  $y < -11$     [D]  $-11 < y < -5$

69. 010207b, P.I. A2.A.42

If  $f(x) = 5x^2$  and  $g(x) = \sqrt{2x}$ , what is the value of  $(f \circ g)(8)$ ?

- [A] 80    [B]  $8\sqrt{10}$     [C] 16    [D] 1,280

70. 010921b, P.I. A2.A.22

Solve for  $x$ :  $\sqrt{x + 18} - 2 = 2$

71. 010521b, P.I. A2.A.44

The accompanying diagram shows the graph of the line whose equation is  $y = -\frac{1}{3}x + 2$ .

On the same set of axes, sketch the graph of the inverse of this function. State the coordinates of a point on the inverse function.

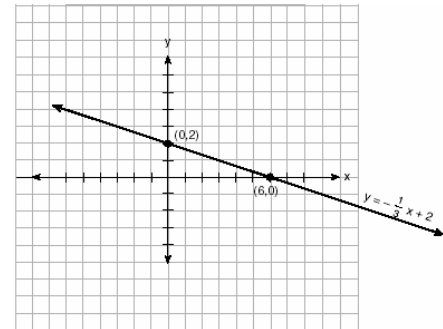

72. 010608b

The expression  $(1 + \cos x)(1 - \cos x)$  is equivalent to

- [A]  $\csc^2 x$     [B]  $\sin^2 x$   
[C]  $\sec^2 x$     [D] 1

73. 010605b, P.I. G.G.61

Which transformation of the graph of  $y = x^2$  would result in the graph of  $y = x^2 + 2$ ?

- [A]  $R_{0,90}$     [B]  $T_{0,2}$     [C]  $D_2$     [D]  $r_{y=2}$

74. 060314b  
Which equation is represented by the accompanying graph?

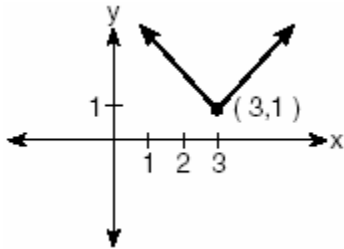

- [A]  $y = |x + 3| - 1$       [B]  $y = (x - 3)^2 + 1$   
[C]  $y = |x| - 3$       [D]  $y = |x - 3| + 1$

75. 010915b  
The expression  $\cot \theta \cdot \sec \theta$  is equivalent to

- [A]  $\frac{\cos \theta}{\sin^2 \theta}$       [B]  $\frac{\sin \theta}{\cos^2 \theta}$   
[C]  $\csc \theta$       [D]  $\sin \theta$

76. 010622b, P.I. A2.A.37  
On the accompanying diagram, draw a mapping of a relation from set  $A$  to set  $B$  that is *not* a function. Explain why the relationship you drew is *not* a function.

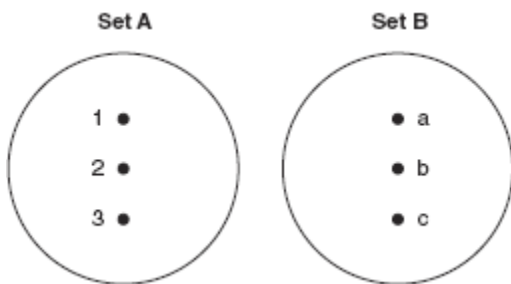

77. 010914b, P.I. A2.A.44  
Given the relation  
 $A: \{(3,2), (5,3), (6,2), (7,4)\}$   
Which statement is true?

- [A] Only  $A^{-1}$  is a function.  
[B] Neither  $A$  nor  $A^{-1}$  are functions.  
[C] Only  $A$  is a function.  
[D] Both  $A$  and  $A^{-1}$  are functions.

78. 080308b, P.I. G.G.54  
Which transformation is *not* an isometry?  
[A] line reflection      [B] translation  
[C] rotation      [D] dilation

79. 010832b, P.I. A2.A.68  
The horizontal distance, in feet, that a golf ball travels when hit can be determined by the formula  $d = \frac{v^2 \sin 2\theta}{g}$ , where  $v$  equals initial velocity, in feet per second;  $g$  equals acceleration due to gravity;  $\theta$  equals the initial angle, in degrees, that the path of the ball makes with the ground; and  $d$  equals the horizontal distance, in feet, that the ball will travel. A golfer hits the ball with an initial velocity of 180 feet per second and it travels a distance of 840 feet. If  $g = 32$  feet per second per second, what is the smallest initial angle the path of the ball makes with the ground, to the *nearest degree*?

80. 010203b, P.I.A2.A.52  
The accompanying graph represents the value of a bond over time.

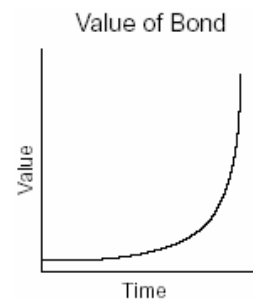

Which type of function does this graph best model?

- [A] trigonometric      [B] logarithmic  
[C] quadratic      [D] exponential

81. 080711b, P.I. G.G.58  
Under a dilation with respect to the origin, the image of  $P(-15,6)$  is  $P'(-5,2)$ . What is the constant of dilation?

[A]  $\frac{1}{3}$  [B] 3 [C] -4 [D] 10

82. 010531b, P.I. A2.A.1  
The heights,  $h$ , of the students in the chorus at Central Middle School satisfy the inequality

$$\left| \frac{h-57.5}{2} \right| \leq 3.25, \text{ when } h \text{ is measured in}$$

*inches*. Determine the interval in which these heights lie and express your answer to the nearest tenth of a foot. [Only an algebraic solution can receive full credit.]

83. 010204b, P.I. A2.A.69  
An object that weighs 2 pounds is suspended in a liquid. When the object is depressed 3 feet from its equilibrium point, it will oscillate according to the formula  $x = 3\cos(8t)$ , where  $t$  is the number of seconds after the object is released. How many seconds are in the period of oscillation?

[A]  $2\pi$  [B]  $\frac{\pi}{4}$  [C]  $\pi$  [D] 3

84. 060418b  
If  $\theta$  is a positive acute angle and  $\sin \theta = a$ , which expression represents  $\cos \theta$  in terms of  $a$ ?

[A]  $\sqrt{a}$  [B]  $\frac{1}{\sqrt{1-a^2}}$

[C]  $\frac{1}{\sqrt{a}}$  [D]  $\sqrt{1-a^2}$

85. 060610b  
The expression  $\frac{1-\cos^2 x}{\sin^2 x}$  is equivalent to

[A]  $\sin x$  [B] -1 [C]  $\cos x$  [D] 1

86. 060329b  
A pair of figure skaters graphed part of their routine on a grid. The male skater's path is represented by the equation  $m(x) = 3\sin \frac{1}{2}x$ , and the female skater's path is represented by the equation  $f(x) = -2\cos x$ . On the accompanying grid, sketch both paths and state how many times the paths of the skaters intersect between  $x = 0$  and  $x = 4\pi$ .

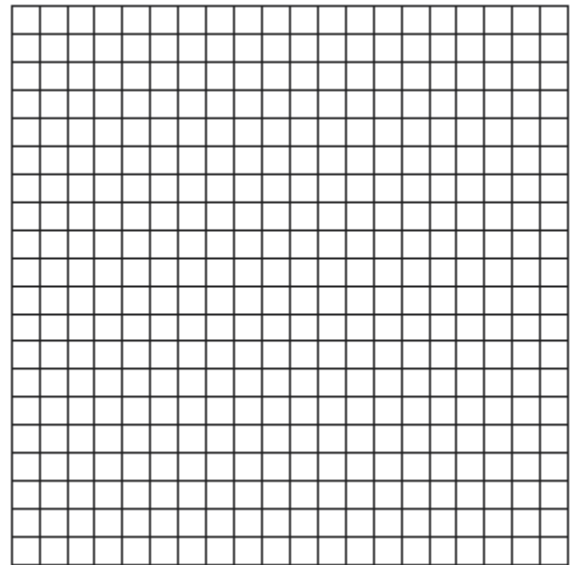

87. 080113b, P.I. A2.A.69  
What is the period of the function  $y = 5\sin 3x$ ?

[A] 5 [B]  $\frac{2\pi}{3}$  [C] 3 [D]  $\frac{2\pi}{5}$

88. 010829b, P.I. A2.A.68  
Find all values of  $x$  in the interval  $0^\circ < x < 360^\circ$  that satisfy the equation  $3\cos x + \sin 2x = 0$ .

89. 080616b  
What is the solution set of the equation  $|x^2 - 2x| = 3x - 6$ ?

[A]  $\{\pm 3\}$  [B]  $\{2, 3\}$

[C]  $\{2, \pm 3\}$  [D]  $\{2\}$

90. 010607b, P.I. A2.A.22

If  $\sqrt{2x-1} + 2 = 5$ , then  $x$  is equal to

- [A] 4      [B] 2      [C] 1      [D] 5

91. 010332b, P.I. A2.A.44

Given:  $f(x) = x^2$  and  $g(x) = 2^x$

a The inverse of  $g$  is a function, but the inverse of  $f$  is not a function. Explain why this statement is true.

b Find  $g^{-1}(f(3))$  to the *nearest tenth*.

92. 060806b, P.I. A2.A.42

If  $f(x) = x^2 + 4$  and  $g(x) = \sqrt{1-x}$ , what is the value of  $f(g(-3))$ ?

- [A] 8      [B] 2      [C] 13      [D]  $2i\sqrt{3}$

93. 060601b, P.I. A.G.3

Each graph below represents a possible relationship between temperature and pressure. Which graph does *not* represent a function?

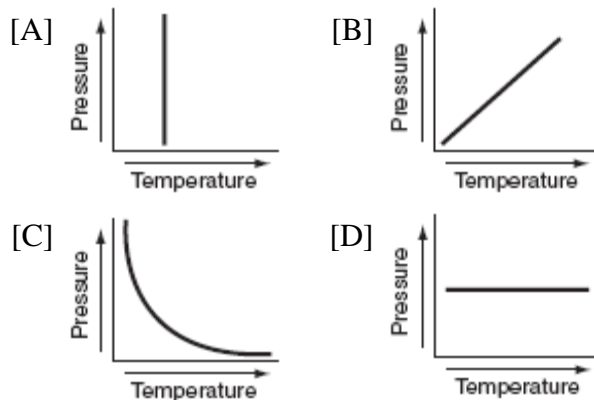

94. 010326b, P.I. A2.A.1

The inequality  $|1.5C - 24| \leq 30$  represents the range of monthly average temperatures,  $C$ , in degrees Celsius, for Toledo, Ohio. Solve for  $C$ .

95. 010904b, P.I. A2.A.4

What is the solution of the inequality  $x^2 - x - 6 < 0$ ?

- [A]  $-2 < x < 3$       [B]  $-3 < x < 2$   
[C]  $-3 < x < -2$       [D]  $1 < x < 6$

96. 060427b, P.I. A2.A.68

Navigators aboard ships and airplanes use nautical miles to measure distance. The length of a nautical mile varies with latitude. The length of a nautical mile,  $L$ , in feet, on the latitude line  $\theta$  is given by the formula  $L = 6,077 - 31\cos 2\theta$ . Find, to the *nearest degree*, the angle  $\theta$ ,  $0 \leq \theta \leq 90^\circ$ , at which the length of a nautical mile is approximately 6,076 feet.

97. 060129b, P.I. G.G.61

Two parabolic arches are to be built. The equation of the first arch can be expressed as  $y = -x^2 + 9$ , with a range of  $0 \leq y \leq 9$ , and the second arch is created by the transformation  $T_{7,0}$ . On the accompanying set of axes, graph the equations of the two arches. Graph the line of symmetry formed by the parabola and its transformation and label it with the proper equation.

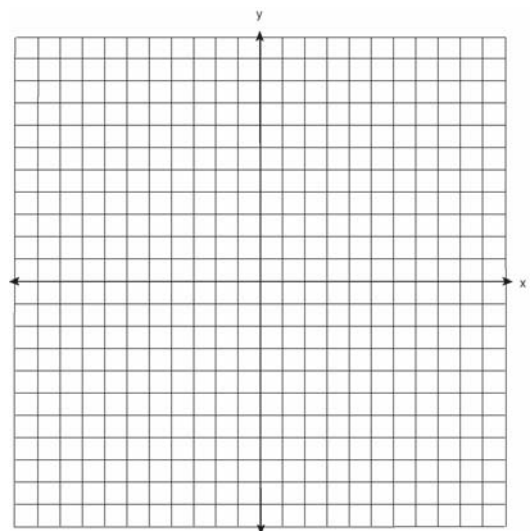

98. 080406b, P.I. A2.A.46

The graph below represents  $f(x)$ .

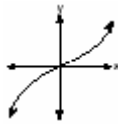

Which graph best represents  $f(-x)$ ?

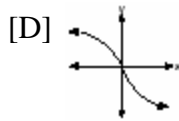
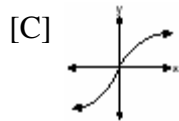
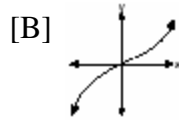
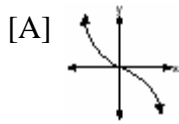

99. 080424b, P.I. A2.A.4

The profit a coat manufacturer makes each day is modeled by the equation

$P(x) = -x^2 + 120x - 2000$ , where  $P$  is the profit and  $x$  is the price for each coat sold.

For what values of  $x$  does the company make a profit? [The use of the grid is optional.]

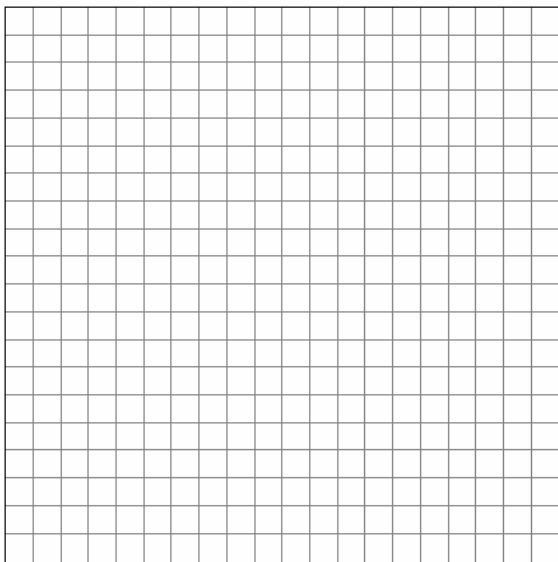

100. 010931b, P.I. A2.A.25

Find the roots of the equation  $x^2 + 7 = 2x$  and express your answer in simplest  $a + bi$  form.

101. 080313b, P.I. A2.A.42

If  $f$  and  $g$  are two functions defined by  $f(x) = 3x + 5$  and  $g(x) = x^2 + 1$ , then  $g(f(x))$  is

[A]  $9x^2 + 26$                       [B]  $3x^2 + 8$

[C]  $9x^2 + 30x + 26$             [D]  $x^2 + 3x + 6$

102. 010331b, P.I. A2.A.42

If  $f(x) = x^{\frac{2}{3}}$  and  $g(x) = 8x^{\frac{1}{2}}$ , find  $(f \circ g)(x)$  and  $(f \circ g)(27)$ .

103. 080133b, P.I. A2.S.7

The availability of leaded gasoline in New York State is decreasing, as shown in the accompanying table.

Year	1984	1988	1992	1996	2000
Gallons Available (in thousands)	150	124	104	76	50

Determine a linear relationship for  $x$  (years) versus  $y$  (gallons available), based on the data given. The data should be entered using the year and gallons available (in thousands), such as (1984,150). If this relationship continues, determine the number of gallons of leaded gasoline available in New York State in the year 2005. If this relationship continues, during what year will leaded gasoline first become unavailable in New York State?

104. 060330b, P.I. A2.A.27

Sean invests \$10,000 at an annual rate of 5% compounded continuously, according to the formula  $A = Pe^{rt}$ , where  $A$  is the amount,  $P$  is the principal,  $e = 2.718$ ,  $r$  is the rate of interest, and  $t$  is time, in years. Determine, to the nearest dollar, the amount of money he will have after 2 years. Determine how many years, to the nearest year, it will take for his initial investment to double.

105. 080833b, P.I. A2.A.68  
Find all values of  $x$  in the interval  $0^\circ \leq x < 360^\circ$  that satisfy the equation  $3\cos 2x = \cos x + 2$ . Express your answers to the nearest degree. [The use of the grid is optional.]

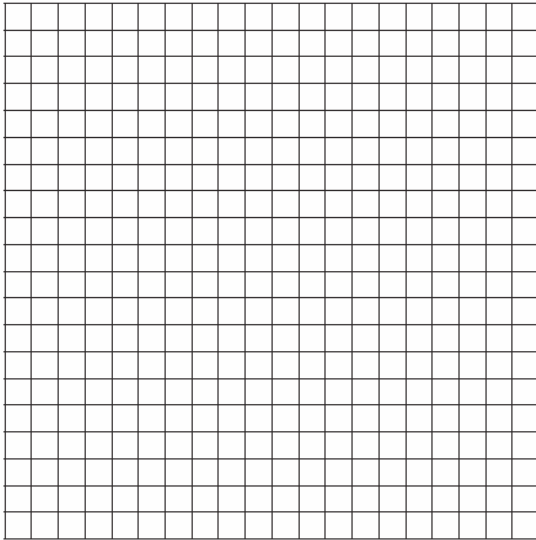

106. 060429b, P.I. A2.A.23  
Solve for  $x$  and express your answer in simplest radical form:  $\frac{4}{x} - \frac{3}{x+1} = 7$

107. 080707b, P.I. A.G.4  
Which equation represents the function shown in the accompanying graph?

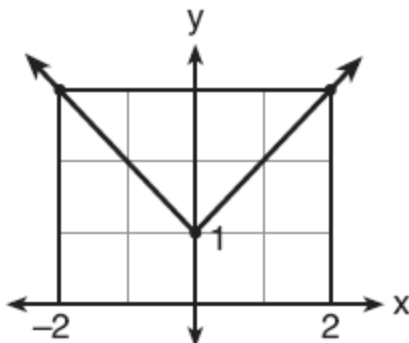

- [A]  $f(x) = |x| - 1$       [B]  $f(x) = |x - 1|$   
[C]  $f(x) = |x + 1|$       [D]  $f(x) = |x| + 1$

108. 010317b, P.I. A2.A.58  
If  $(\sec x - 2)(2 \sec x - 1) = 0$ , then  $x$  terminates in  
[A] Quadrants I and II, only  
[B] Quadrant I, only  
[C] Quadrants I and IV, only  
[D] Quadrants I, II, III, and IV

109. 060522b, P.I. A2.A.27  
Solve for  $m$ :  $3^{m+1} - 5 = 22$

110. 060731b, P.I. A2.A.68  
The average annual snowfall in a certain region is modeled by the function  $S(t) = 20 + 10\cos\left(\frac{\pi}{5}t\right)$ , where  $S$  represents the annual snowfall, in inches, and  $t$  represents the number of years since 1970. What is the minimum annual snowfall, in inches, for this region? In which years between 1970 and 2000 did the minimum amount of snow fall? [The use of the grid is optional.]

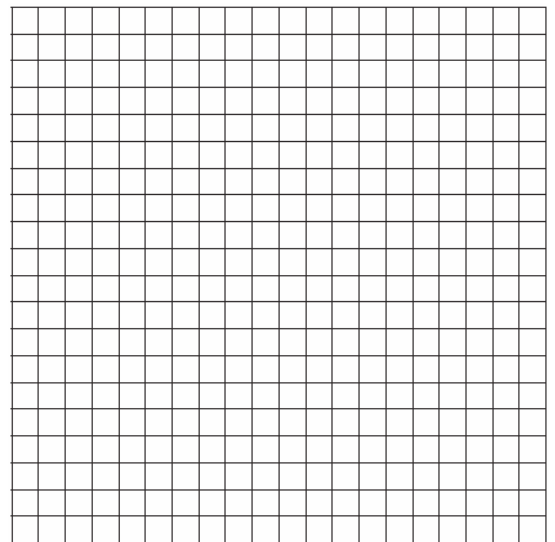

111. 060322b, P.I. A2.A.42  
If  $f(x) = 2^x - 1$  and  $g(x) = x^2 - 1$ , determine the value of  $(f \circ g)(3)$ .



112. 080509b, P.I. A2.A.1

The solution of  $|2x - 3| < 5$  is

- [A]  $-1 < x < 4$       [B]  $x < 4$   
[C]  $x < -1$  or  $x > 4$       [D]  $x > -1$

113. 010218b, P.I. A2.A.39

What is the domain of  $h(x) = \sqrt{x^2 - 4x - 5}$ ?

- [A]  $\{x|x \geq 1 \text{ or } x \leq -5\}$   
[B]  $\{x|-5 \leq x \leq 1\}$       [C]  $\{x|-1 \leq x \leq 5\}$   
[D]  $\{x|x \geq 5 \text{ or } x \leq -1\}$

114. fall9905b, P.I. A2.A.77

If  $x$  is an acute angle, and  $\cos x = \frac{4}{5}$ , then  $\cos 2x$  is equal to

- [A]  $\frac{6}{25}$       [B]  $\frac{-1}{25}$       [C]  $\frac{2}{25}$       [D]  $\frac{7}{25}$

115. 080520b, P.I. A2.A.42

The accompanying graph is a sketch of the function  $y = f(x)$  over the interval  $0 \leq x \leq 7$ .

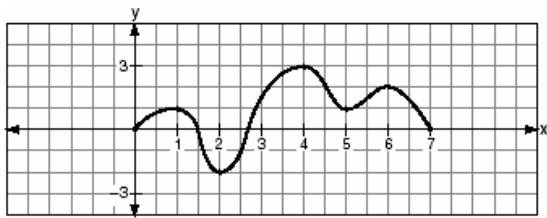

What is the value of  $(f \circ f)(6)$ ?

- [A] -2      [B] 1      [C] 0      [D] 2

116. 060213b, P.I. A2.A.38

Which equation represents a function?

- [A]  $x = y^2 - 6x + 8$       [B]  $4y^2 = 36 - 9x^2$   
[C]  $x^2 + y^2 = 4$       [D]  $y = x^2 - 3x - 4$

117. 060511b, P.I. A2.A.38

Which relation is a function?

- [A]  $x = 7$       [B]  $xy = 7$   
[C]  $x^2 + y^2 = 7$       [D]  $x^2 - y^2 = 7$

118. fall9927b, P.I. A2.A.54

Sketch the graph of the functions  $f(x) = 3^x$  and  $g(x) = \log_3 x$ . Considering the graphs, describe the relationship between  $f(x)$  and  $g(x)$ . Specify the domain and the range of  $g$ .

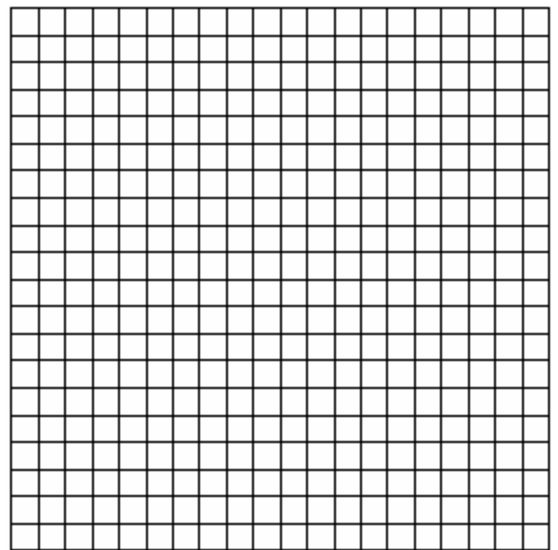

119. 010427b, P.I. A2.A.22

Solve algebraically:  $\sqrt{x+5} + 1 = x$

120. 080812b, P.I. A2.A.38

Which equation is *not* a function?

- [A]  $y = \sec x$       [B]  $y = \sin x$   
[C]  $y = 3x^2 - 4$       [D]  $x^2 = 16 - y^2$

121. 060829b, P.I. A2.A.68

Find all values of  $\theta$  in the interval  $0^\circ \leq \theta < 360^\circ$  that satisfy the equation  $3\cos 2\theta + 2\sin \theta + 1 = 0$ , and round all answers to the *nearest hundredth of a degree*. [Only an algebraic solution can receive full credit.]



127. 010804b, P.I. G.G.56

Matthew is a fan of the Air Force's Thunderbirds flying team and is designing a jacket patch for the team, as shown in the accompanying diagram.

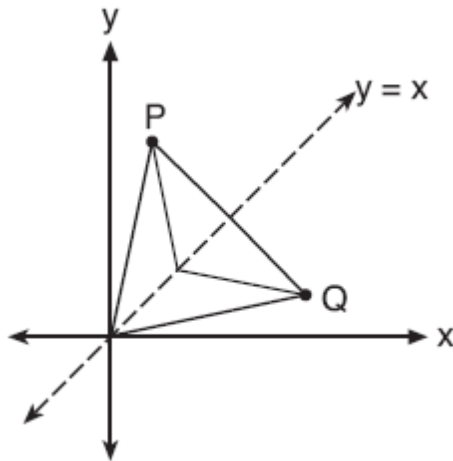

If  $P$  has the coordinates  $(a,b)$ , what are the coordinates of  $Q$ , the reflection of  $P$  in the line  $y = x$ ?

- [A]  $(y,x)$                       [B]  $(a,b)$   
[C]  $(b,a)$                       [D]  $(-a,b)$

128. 060724b, P.I. G.G.12

Denise is designing a storage box in the shape of a cube. Each side of the box has a length of 10 inches. She needs more room and decides to construct a larger box in the shape of a cube with a volume of 2,000 cubic inches. By how many inches, to the *nearest tenth*, should she *increase* the length of each side of the original box?

129. 010817b, P.I. A2.A.2

Which equation has roots that are real, rational, and unequal?

- [A]  $x^2 + x + 1 = 0$             [B]  $x^2 - 4 = 0$   
[C]  $x^2 - 2 = 0$                 [D]  $x^2 - 4x + 4 = 0$

130. 010511b, P.I. A.G.3

Which graph is *not* a function?

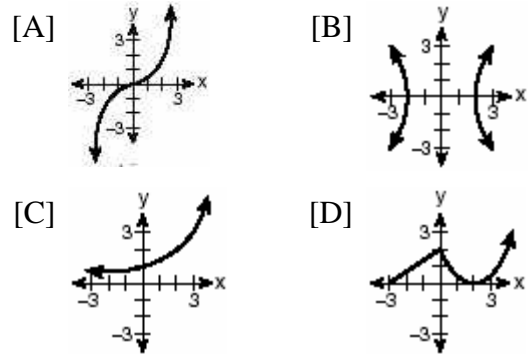

131. 060607b, P.I. A.A.9

The height,  $f(x)$ , of a bouncing ball after  $x$  bounces is represented by  $f(x) = 80(0.5)^x$ . How many times higher is the first bounce than the fourth bounce?

- [A] 4            [B] 8            [C] 16            [D] 2

132. 060424b, P.I. G.G.56

In the accompanying diagram of square  $ABCD$ ,  $F$  is the midpoint of  $\overline{AB}$ ,  $G$  is the midpoint of  $\overline{BC}$ ,  $H$  is the midpoint of  $\overline{CD}$ , and  $E$  is the midpoint of  $\overline{DA}$ .

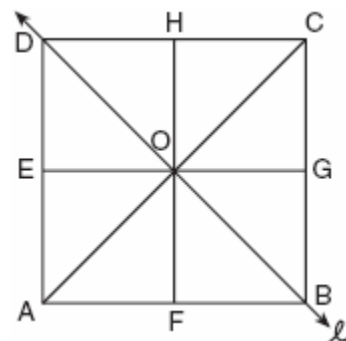

Find the image of  $\triangle EOA$  after it is reflected in line  $\ell$ . Is this isometry direct or opposite? Explain your answer.

133. 010626b, P.I. A2.A.27

Solve algebraically for  $x$ :  $8^{2x} = 4^6$

134. 060710b  
A function,  $f$ , is defined by the set  $\{(2,3), (4,7), (-1,5)\}$ . If  $f$  is reflected in the line  $y = x$ , which point will be in the reflection?

[A] (-1,5)                      [B] (5,-1)  
[C] (-5,1)                      [D] (1,-5)

135. 060233b  
On a monitor, the graphs of two impulses are recorded on the same screen, where  $0^\circ \leq x < 360^\circ$ . The impulses are given by the following equations:

$$y = 2 \sin^2 x$$

$$y = 1 - \sin x$$

Find all values of  $x$ , in degrees, for which the two impulses meet in the interval  $0^\circ \leq x < 360^\circ$ . [Only an algebraic solution will be accepted.]

136. 060801b, P.I. A.A.15  
For which value of  $x$  is  $\frac{1}{27 - 3^x}$  undefined?

[A] -3      [B] 1      [C] 0      [D] 3

137. 010532b, P.I. A2.A.22  
The number of people,  $y$ , involved in recycling in a community is modeled by the function  $y = 90\sqrt{3x} + 400$ , where  $x$  is the number of months the recycling plant has been open. Construct a table of values, sketch the function on the grid, and find the number of people involved in recycling exactly 3 months after the plant opened. After how many months will 940 people be involved in recycling?

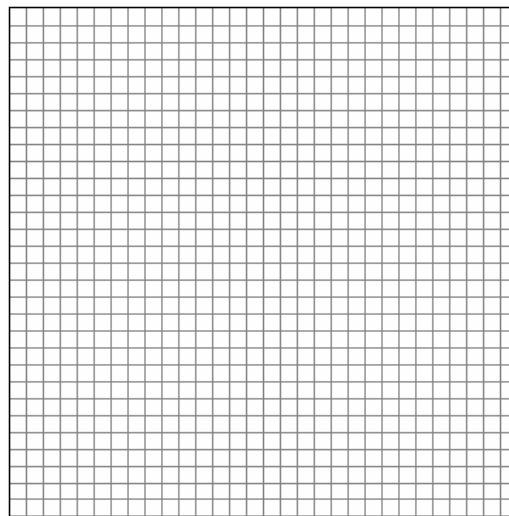

138. 080617b, P.I. A2.A.77  
The expression  $\frac{\sin 2\theta}{\sin^2 \theta}$  is equivalent to

[A]  $2 \tan \theta$                       [B]  $2 \cot \theta$

[C]  $\frac{2}{\sin \theta}$                       [D]  $2 \cos \theta$

139. 010801b  
Which equation is represented by the accompanying graph?

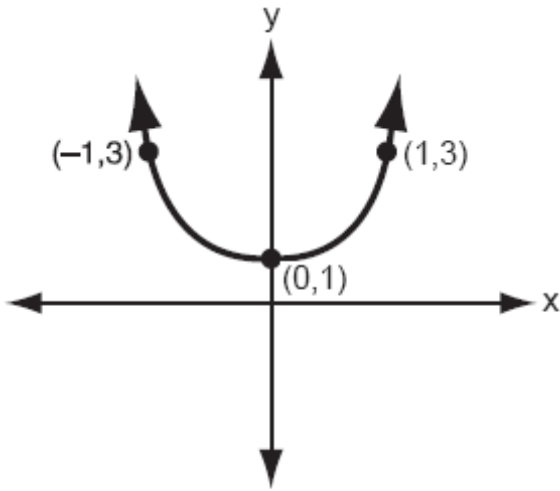

- [A]  $y = x^2$                       [B]  $y = 2(x^2 + 1)$   
[C]  $y = 2x^2 + 1$               [D]  $y = 2x^2$

140. 060617b, P.I. A2.A.1  
The solution set of which inequality is represented by the accompanying graph?

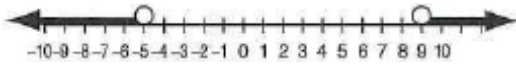

- [A]  $|2 - x| < -7$               [B]  $|x - 2| < 7$   
[C]  $|2 - x| > -7$               [D]  $|x - 2| > 7$

141. 080229b, P.I. A.A.41  
A rock is thrown vertically from the ground with a velocity of 24 meters per second, and it reaches a height of  $2 + 24t - 4.9t^2$  after  $t$  seconds. How many seconds after the rock is thrown will it reach maximum height, and what is the maximum height the rock will reach, in meters? How many seconds after the rock is thrown will it hit the ground? Round your answers to the *nearest hundredth*. [Only an algebraic or graphic solution will be accepted.]

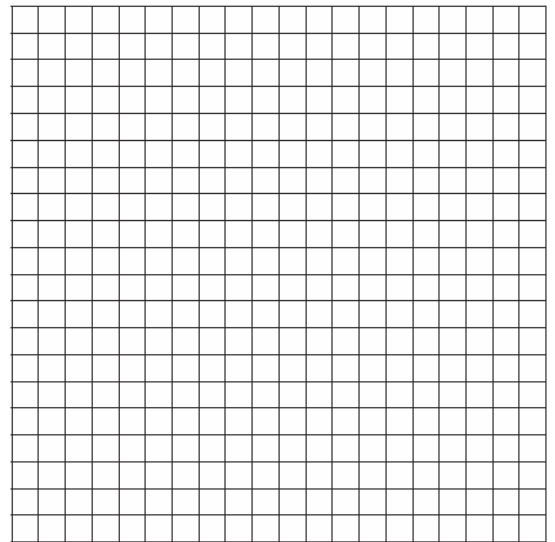

142. 080301b, P.I. A.G.3  
Which graph does not represent a function of  $x$ ?

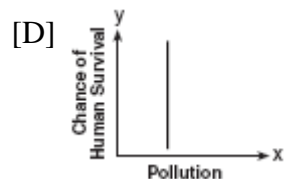
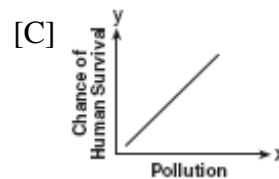
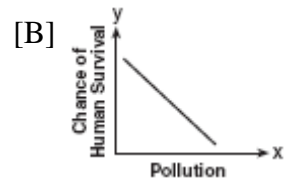
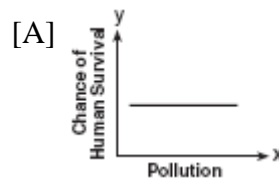

143. 080610b, P.I. A2.A.68  
A solution set of the equation  $5\sin\theta + 3 = 3$  contains all multiples of  
[A]  $180^\circ$    [B]  $90^\circ$    [C]  $135^\circ$    [D]  $45^\circ$

144. 080503b

The graphs below show the average annual precipitation received at different latitudes on Earth. Which graph is a translated cosine curve?

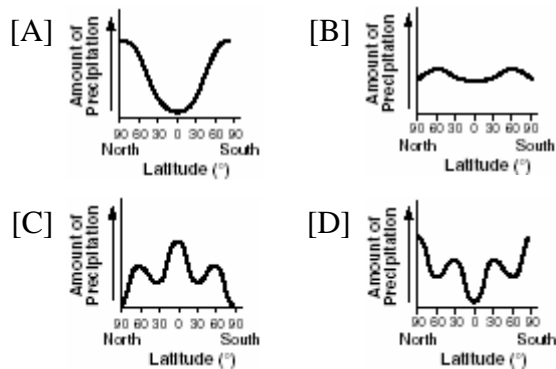

145. 060530b, P.I. A2.A.68

Find, to the nearest degree, all values of  $\theta$  in the interval  $0^\circ < \theta < 360^\circ$  that satisfy the equation  $3\cos 2\theta + \sin \theta - 1 = 0$ .

146. 010612b, P.I. A2.A.72

In physics class, Eva noticed the pattern shown in the accompanying diagram on an oscilloscope.

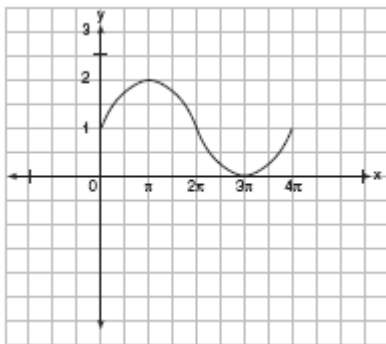

Which equation best represents the pattern shown on this oscilloscope?

- [A]  $y = 2 \sin x + 1$       [B]  $y = \sin\left(\frac{1}{2}x\right) + 1$
- [C]  $y = 2 \sin\left(-\frac{1}{2}x\right) + 1$
- [D]  $y = \sin x + 1$

147. 080712b, P.I. A2.A.44

Which graph has an inverse that is a function?

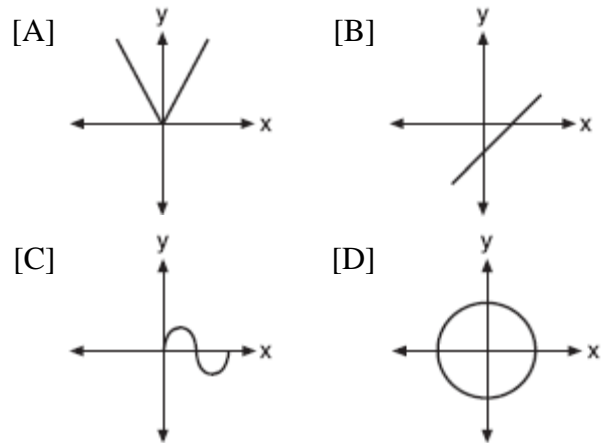

148. fall9902b

The graph below can be represented by which equation?

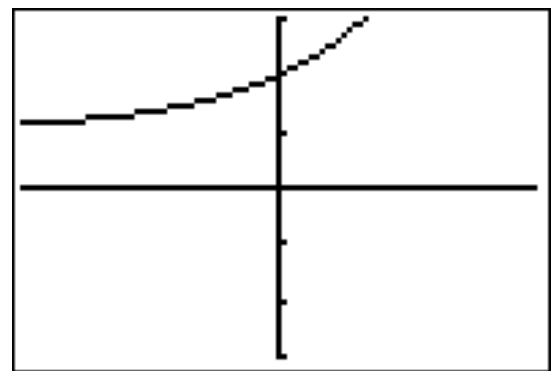

- [A]  $y = 2^{x+1}$       [B]  $y = 2^x$
- [C]  $y = x^2 + 2$       [D]  $y = 2^x + 1$

149. 010523b, P.I. A2.A.68

Solve the following equation algebraically for all values of  $\theta$  in the interval  $0^\circ \leq \theta \leq 180^\circ$ .

$$2 \sin \theta - 1 = 0$$

150. 080714b

The graph of which function is symmetric with respect to the graph of the line  $y = x$ ?

- [A]  $y = \frac{1}{x}$       [B]  $y = x^3$
- [C]  $y = x^2$       [D]  $y = \log x$

151. 060413b, P.I. A2.A.77

If  $\theta$  is an acute angle such that  $\sin \theta = \frac{5}{13}$ ,

what is the value of  $\sin 2\theta$ ?

- [A]  $\frac{120}{169}$  [B]  $\frac{12}{13}$  [C]  $\frac{60}{169}$  [D]  $\frac{10}{26}$

152. 060612b, P.I. A2.A.27

The solution set of  $2^{x^2+2x} = 2^{-1}$  is

- [A]  $\{-1, 1\}$  [B]  $\{-1\}$  [C]  $\{1\}$  [D]  $\{\}$

153. 010727b, P.I. A2.A.68

Find, to the *nearest degree*, all values of  $\theta$  in the interval  $0^\circ \leq \theta \leq 180^\circ$  that satisfy the equation  $8\cos^2 \theta - 2\cos \theta - 1 = 0$ .

154. 010210b, P.I. G.G.61

Which transformation is *not* an isometry?

- [A]  $T_{3,6}$  [B]  $R_{0,90^\circ}$  [C]  $D_2$  [D]  $r_{y=x}$

155. 060707b, P.I. A2.A.1

Which inequality is represented by the accompanying graph?



- [A]  $|x + 2| > 5$  [B]  $|x - 5| \geq 2$   
[C]  $|x + 3| \geq 2$  [D]  $|x - 1| \leq 5$

156. 010709b, P.I. A2.A.27

What is the value of  $b$  in the equation

$$4^{2b-3} = 8^{1-b}?$$

- [A]  $\frac{-3}{7}$  [B]  $\frac{10}{7}$  [C]  $\frac{9}{7}$  [D]  $\frac{7}{9}$

157. 010906b, P.I. A2.A.46

What is the translation that maps the function  $f(x) = x^2 - 1$  onto the function  $g(x) = x^2 + 1$ ?

- [A]  $T_{0,1}$  [B]  $T_{0,2}$  [C]  $T_{-1,1}$  [D]  $T_{1,-1}$

158. 080634b, P.I. A2.A.25

Barb pulled the plug in her bathtub and it started to drain. The amount of water in the bathtub as it drains is represented by the equation  $L = -5t^2 - 8t + 120$ , where  $L$  represents the number of liters of water in the bathtub and  $t$  represents the amount of time, in minutes, since the plug was pulled. How many liters of water were in the bathtub when Barb pulled the plug? Show your reasoning. Determine, to the *nearest tenth of a minute*, the amount of time it takes for all the water in the bathtub to drain.

159. 060532b, P.I. A2.A.4

The height of a projectile is modeled by the equation  $y = -2x^2 + 38x + 10$ , where  $x$  is time, in seconds, and  $y$  is height, in feet. During what interval of time, to the *nearest tenth of a second*, is the projectile *at least* 125 feet above ground? [The use of the grid is optional.]

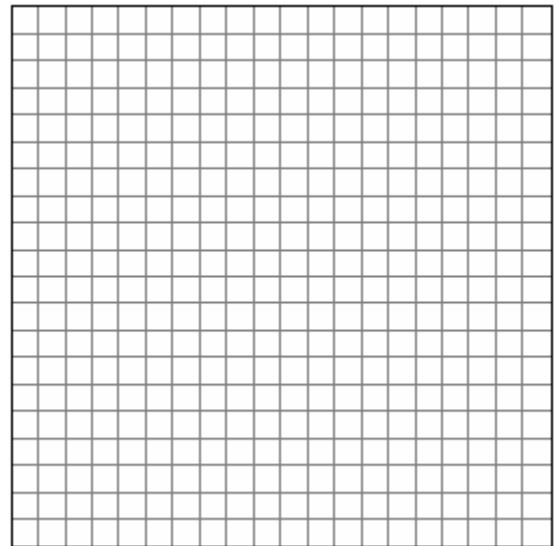

160. 080526b

Express in simplest terms:  $\frac{2 - 2\sin^2 x}{\cos x}$

161. 060833b, P.I. A2.A.28

Solve for  $x$ :  $\log_3(x^2 - 4) - \log_3(x + 2) = 2$

162. 080134b, P.I. G.G.69

Given:  $A(1,6)$ ,  $B(7,9)$ ,  $C(13,6)$ , and  $D(3,1)$   
Prove:  $ABCD$  is a trapezoid. [*The use of the accompanying grid is optional.*]

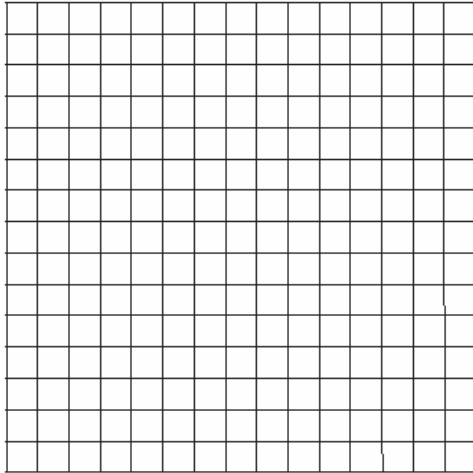

163. 060528b, P.I. A2.A.22

Solve for all values of  $q$  that satisfy the equation  $\sqrt{3q+7} = q+3$ .

164. 080231b, P.I. G.G.61

Graph and label the following equations,  $a$  and  $b$ , on the accompanying set of coordinate axes.

$$a: y = x^2$$

$$b: y = -(x-4)^2 + 3$$

Describe the composition of transformations performed on  $a$  to get  $b$ .

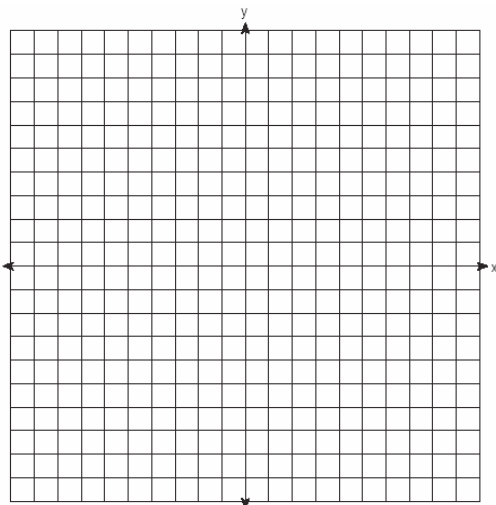

165. fall9926b, P.I. G.G.50

Two docks,  $A$  and  $B$ , are located on a circular pond as shown in the diagram below. A surveyor wants to determine the distance these two docks are from each other across the pond. The surveyor, located at point  $S$ , knows that he is 200 yards from both docks and his measuring equipment indicates that there is a  $90^\circ$  angle between his sight lines to dock  $A$  and to dock  $B$ . How far, to the nearest tenth of a yard, is it across the pond from dock  $A$  to dock  $B$ ?

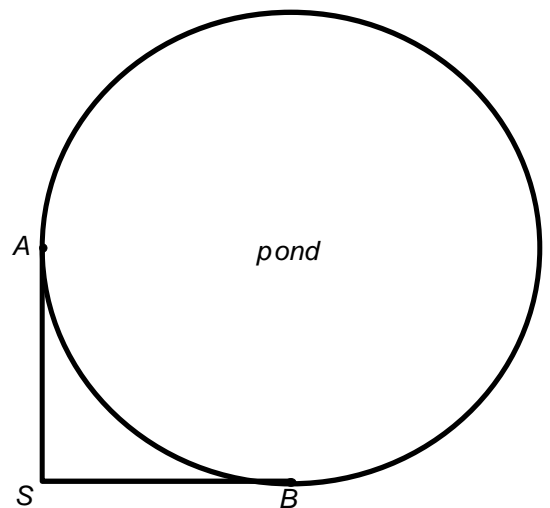

166. 080315b

The expression  $\frac{2 \cos \theta}{\sin 2\theta}$  is equivalent to

- [A]  $\csc \theta$                       [B]  $\sec \theta$   
[C]  $\cot \theta$                       [D]  $\sin \theta$

167. 080104b, P.I. A2.A.22

The solution set of the equation  $\sqrt{x+6} = x$  is

- [A]  $\{ \}$     [B]  $\{-2\}$     [C]  $\{3\}$     [D]  $\{-2,3\}$



168. 060405b, P.I. G.G.60

In the accompanying graph, the shaded region represents set  $A$  of all points  $(x,y)$  such that  $x^2 + y^2 \leq 1$ . The transformation  $T$  maps point  $(x, y)$  to point  $(2x, 4y)$ .

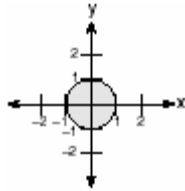

Which graph shows the mapping of set  $A$  by the transformation  $T$ ?

[A]

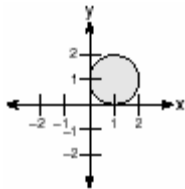

[B]

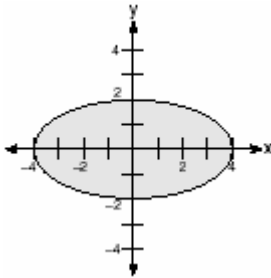

[C]

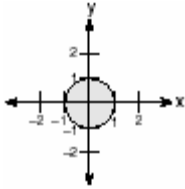

[D]

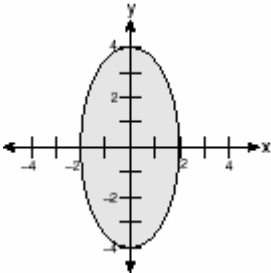

169. 080234b, P.I. A2.A.23

Electrical circuits can be connected in series, one after another, or in parallel circuits that branch off a main line. If circuits are hooked up in parallel, the reciprocal of the total resistance in the series is found by adding the reciprocals of each resistance, as shown in the accompanying diagram.

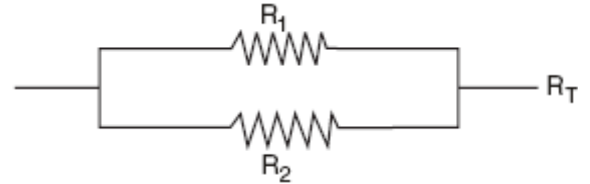

$$\frac{1}{R_1} + \frac{1}{R_2} = \frac{1}{R_T}$$

If  $R_1 = x$ ,  $R_2 = x + 3$ , and the total resistance,  $R_T$ , is 2.25 ohms, find the positive value of  $R_1$  to the nearest tenth of an ohm.

170. 080227b, P.I. A2.A.23

The cost ( $C$ ) of selling  $x$  calculators in a store is modeled by the equation

$$C = \frac{3,200,000}{x} + 60,000.$$

The store profit ( $P$ )

for these sales is modeled by the equation  $P = 500x$ . What is the minimum number of calculators that have to be sold for profit to be greater than cost?

171. 060715b, P.I. A.G.3

Which set of ordered pairs does *not* represent a function?

[A]  $\{(3,-2), (4,-3), (5,-4), (6,-5)\}$

[B]  $\{(3,-2), (3,-4), (4,-1), (4,-3)\}$

[C]  $\{(3,-2), (5,-2), (4,-2), (-1,-2)\}$

[D]  $\{(3,-2), (-2,3), (4,-1), (-1,4)\}$



181. 010822b, A2.A.1  
Solve for all values of  $x$ :  $|2x - 5| = 3$

182. 010703b, P.I. A.A.23  
If  $\sqrt{x - a} = b, x > a$ , which expression is equivalent to  $x$ ?

- [A]  $b^2 - a$                       [B]  $b + a$   
[C]  $b - a$                         [D]  $b^2 + a$

183. 060216b, P.I. A2.A.43  
Which diagram represents a one-to-one function?

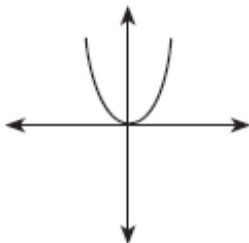
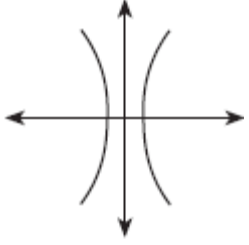
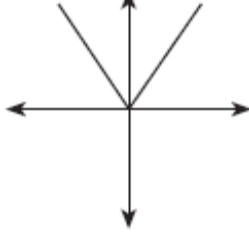
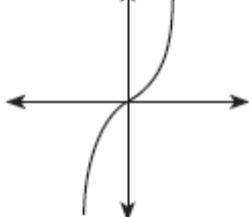
- [A] 
- [B] 
- [C] 
- [D] 

184. 010320b, P.I. A2.A.58  
If  $\sin 6A = \cos 9A$ , then  $m\angle A$  is equal to  
[A] 6      [B] 54      [C] 36      [D]  $1\frac{1}{2}$

185. 080710b, P.I.A2.A.52  
Which type of function could be used to model the data shown in the accompanying graph?

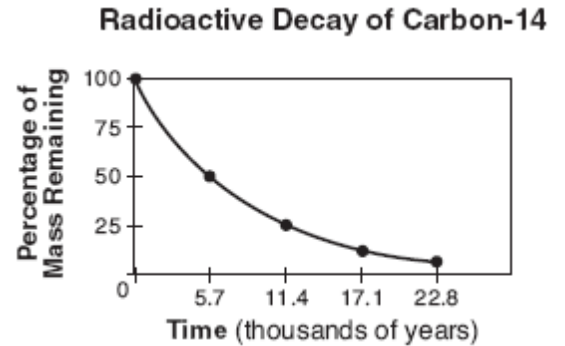

- [A] quadratic                      [B] exponential  
[C] trigonometric                [D] linear

186. 080810b, P.I. G.G.59  
Under the transformation  $(x, y) \rightarrow (2x, 2y)$ , which property is *not* preserved?

- [A] angle measure                [B] distance  
[C] parallelism                    [D] orientation

187. 060422b, P.I. A2.A.27  
Solve algebraically for  $x$ :  $27^{2x+1} = 9^{4x}$

188. 010414b, P.I. A.G.4  
The graph below represents  $f(x)$ .

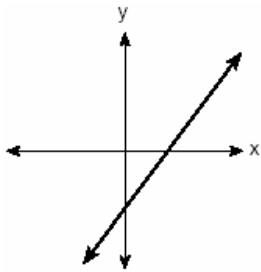

Which graph best represents  $|f(x)|$ ?

- [A] (1)
- [B] (3)
- [C] (2)
- [D] (4)

189. 010508b  
The expression  $\frac{\tan \theta}{\sec \theta}$  is equivalent to

- [A]  $\frac{\cos^2 \theta}{\sin \theta}$       [B]  $\sin \theta$
- [C]  $\cos \theta$       [D]  $\frac{\sin \theta}{\cos^2 \theta}$

190. 080625b, P.I. A2.S.4  
Beth's scores on the six Earth science tests she took this semester are 100, 95, 55, 85, 75, and 100. For this population, how many scores are within one standard deviation of the mean?

191. 060725b, P.I. A2.A.42  
If  $f(x) = \log_2 x$  and  $g(x) = 2x^2 + 14$ , determine the value of  $(f \circ g)(5)$ .

192. 080602b, P.I. A2.A.22  
What is the solution of the equation  $\sqrt{2x-3}-3=6$ ?
- [A] 3      [B] 6      [C] 42      [D] 39

193. 080432b, P.I. A2.A.68  
Solve algebraically for all values of  $\theta$  in the interval  $0^\circ \leq \theta \leq 360^\circ$  that satisfy the equation  $\frac{\sin^2 \theta}{1 + \cos \theta} = 1$ .

194. 080327b, P.I. G.G.61  
On the accompanying grid, graph and label  $\overline{AB}$ , where  $A$  is  $(0,5)$  and  $B$  is  $(2,0)$ . Under the transformation  $r_{x\text{-axis}} \circ r_{y\text{-axis}}(\overline{AB})$ ,  $A$  maps to  $A''$  and  $B$  maps to  $B''$ . Graph and label  $\overline{A''B''}$ . What single transformation would map  $\overline{AB}$  to  $\overline{A''B''}$ ?

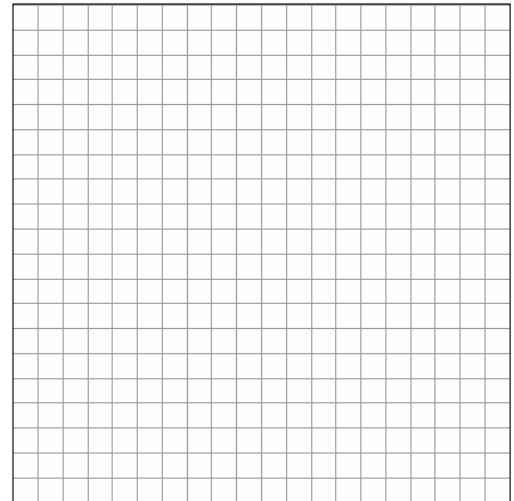

195. 060717b, P.I. A2.A.2  
Which number is the discriminant of a quadratic equation whose roots are real, unequal, and irrational?
- [A] 4      [B] 7      [C] -5      [D] 0