

JEFFERSON MATH PROJECT

REGENTS BY TOPIC

All 680 NY Math B Regents Exam Questions
from June 2001 to August 2007 Sorted by Topic

www.jmap.org



Dear Sir

I have to acknowledge the receipt of your favor of May 14. in which you mention that you have finished the 6. first books of Euclid, plane trigonometry, surveying & algebra and ask whether I think a further pursuit of that branch of science would be useful to you. there are some propositions in the latter books of Euclid, & some of Archimedes, which are useful, & I have no doubt you have been made acquainted with them. trigonometry, so far as this, is most valuable to every man, there is scarcely a day in which he will not resort to it for some of the purposes of common life. the science of calculation also is indispensable as far as the extraction of the square & cube roots; Algebra as far as the quadratic equation & the use of logarithms are often of value in ordinary cases: but all beyond these is but a luxury; a delicious luxury indeed; but not to be indulged in by one who is to have a profession to follow for his subsistence. in this light I view the conic sections, curves of the higher orders, perhaps even spherical trigonometry, Algebraical operations beyond the 2d dimension, and fluxions.

Letter from Thomas Jefferson to William G. Munford, Monticello, June 18, 1799.

TABLE OF CONTENTS

ALGEBRA		
<u>TOPICS</u>	<u>KEYWORDS/SUBTOPICS</u>	<u>QUESTION NUMBER</u>
NUMBERS OPERATIONS AND PROPERTIES	Absolute Value	1-3
	Properties of Integers	4
	Imaginary Numbers	5-13
	Complex Numbers	14-33
	Summations	34-47
GRAPHS AND STATISTICS	Relating Graphs to Events	48
	Central Tendency	49-50
	Standard Deviation	51-60
	Regression	61-78
	Correlation Coefficient	79-83
	Normal Distributions	84-95
PROBABILITY	Normal Probability	96-98
	Binomial Probability	99-118
EQUATIONS	Transforming Formulas	119-121
	Absolute Value Equations	122
RATE	Speed	123-126
FUNCTIONS	Three Views of a Function	127-132
	Modeling Relationships	133
	Defining Functions	134-146
	Compositions of Functions	147-159
	Operations with Functions	160-162
	Inverse of Functions	163-173
SYSTEMS	Writing Linear Systems	174-175
	Break Even	176-177
	Solving Nonlinear Systems	178-191
INEQUALITIES	Absolute Value Inequalities	192-205
	Quadratic Inequalities	206-212
	Trigonometric Inequalities	213-215

QUADRATICS	Solving Quadratics by Factoring 216 Quadratic Functions 217-223 Minimum and Maximum of Quadratics 224-234 Quadratics with Noninteger Solutions 235-248 Using the Discriminant 249-267
POWERS	Zero and Negative Powers 268 Operations with Powers 269-270 Exponential Functions 271-281 Properties of Logarithms 282-294 Graphing Logarithmic Functions 295-296 Logarithmic Equations 297-306 Exponential Equations 307-325 Binomial Expansions 326-330
RADICALS	Operations with Radicals 331 Rationalizing Denominators 332-343 Properties of Radicals 344-347 Solving Radicals 348-359 Exponents as Radicals 360-371
RATIONALS	Multiplication and Division of Rationals 372-376 Addition and Subtraction of Rationals 377-380 Solving Rationals 381-387 Rational Expressions 388-393 Rational Functions 394-401 Complex Fractions 402-415 Inverse Variation 416-428
GEOMETRY	
ANGLES	Unit Circle 429-446 Radian Measure 447-456 Trigonometric Identities 457-465 Double Angle and Angle Sum and Difference Identities 466-478 Solving Trigonometric Equations 479-491 Trigonometric Graphs 492-513
TRIANGLES	Pythagoras 514-515 Perimeter and Area of Triangles 516-518 Triangle Inequalities 519 Basic Trigonometric Ratios 520 Using Trigonometry to Find Area 521-528 Law of Cosines 529-538 Law of Sines 539-553 Using Trigonometry to Solve Triangle Inequalities 554-562 Vectors 563-567

OTHER POLYGONS	Perimeter and Area of Other Polygons 568-570
CONICS	Circumference and Area 571-579 Equations of Circles 580-586 Equations of Ellipses 587-595 Chords Secants and Tangents 596-617
SOLIDS AND SIMILARITY	Volume 618-619 Similarity 620
TRANSFORMATIONS	Symmetry 621 Identifying Transformations 622 Translations 623-624 Dilations 625-629 Reflections 630-636 Isometries 637-642 Rotations 643 Compositions of Transformations 644-654
LOGIC	Proofs 655-680

NUMBERS OPERATIONS AND PROPERTIES

ABSOLUTE VALUE

1. Which equation is represented by the accompanying graph?

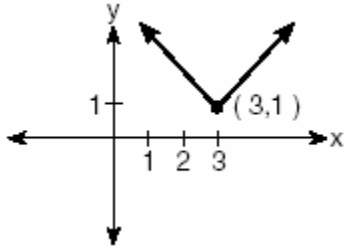

- [A] $y = |x| - 3$ [B] $y = |x - 3| + 1$
 [C] $y = |x + 3| - 1$ [D] $y = (x - 3)^2 + 1$

2. Which equation represents the function shown in the accompanying graph?

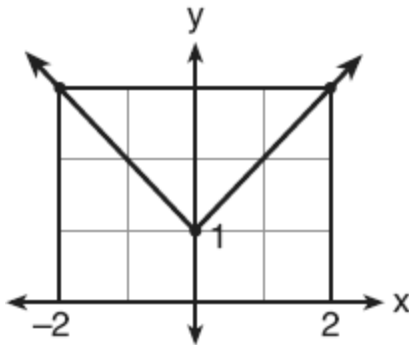

- [A] $f(x) = |x| + 1$ [B] $f(x) = |x - 1|$
 [C] $f(x) = |x + 1|$ [D] $f(x) = |x| - 1$

3. The graph below represents $f(x)$.

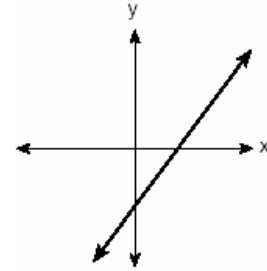

Which graph best represents $|f(x)|$?

- [A] [B] [C] [D]

PROPERTIES OF INTEGERS

4. Tom scored 23 points in a basketball game. He attempted 15 field goals and 6 free throws. If each successful field goal is 2 points and each successful free throw is 1 point, is it possible he successfully made all 6 of his free throws? Justify your answer.

IMAGINARY NUMBERS

5. The expression i^{25} is equivalent to
 [A] $-i$ [B] i [C] 1 [D] -1
6. Mrs. Donahue made up a game to help her class learn about imaginary numbers. The winner will be the student whose expression is equivalent to $-i$. Which expression will win the game?
 [A] i^{48} [B] i^{49} [C] i^{47} [D] i^{46}

7. Expressed in simplest form, $i^{16} + i^6 - 2i^5 + i^{13}$ is equivalent to
 [A] i [B] -1 [C] 1 [D] $-i$
8. When simplified, $i^{27} + i^{34}$ is equal to
 [A] $i-1$ [B] i [C] $-i-1$ [D] i^{61}
9. What is the value of $i^{99} - i^3$?
 [A] i^{96} [B] 1 [C] $-i$ [D] 0
10. What is the sum of $\sqrt{-2}$ and $\sqrt{-18}$?
 [A] $5i\sqrt{2}$ [B] $6i$
 [C] $4i\sqrt{2}$ [D] $2i\sqrt{5}$
11. The expression $i^0 \cdot i^1 \cdot i^2 \cdot i^3 \cdot i^4$ is equal to
 [A] i [B] 1 [C] $-i$ [D] -1
12. The expression $\frac{i^{16}}{i^3}$ is equivalent to
 [A] 1 [B] $-i$ [C] i [D] -1
13. What is the multiplicative inverse of $3i$?
 [A] $-\frac{i}{3}$ [B] $\frac{1}{3}$ [C] $-3i$ [D] -3

COMPLEX NUMBERS

14. Fractal geometry uses the complex number plane to draw diagrams, such as the one shown in the accompanying graph.

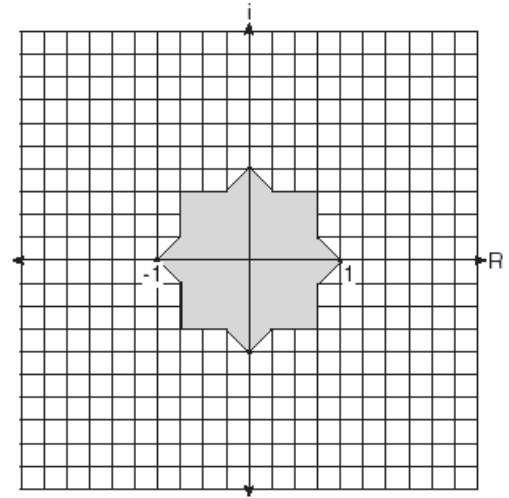

Which number is *not* included in the shaded area?

- [A] -0.9 [B] $-0.5i$
 [C] $-0.5 - 0.5i$ [D] $-0.9 - 0.9i$
15. Two complex numbers are graphed below.

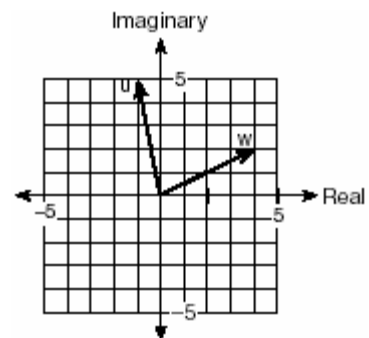

What is the sum of w and u , expressed in standard complex number form?

- [A] $7 + 3i$ [B] $5 + 7i$
 [C] $3 + 7i$ [D] $-5 + 3i$

16. On a stamp honoring the German mathematician Carl Gauss, several complex numbers appear. The accompanying graph shows two of these numbers. Express the sum of these numbers in $a + bi$ form.

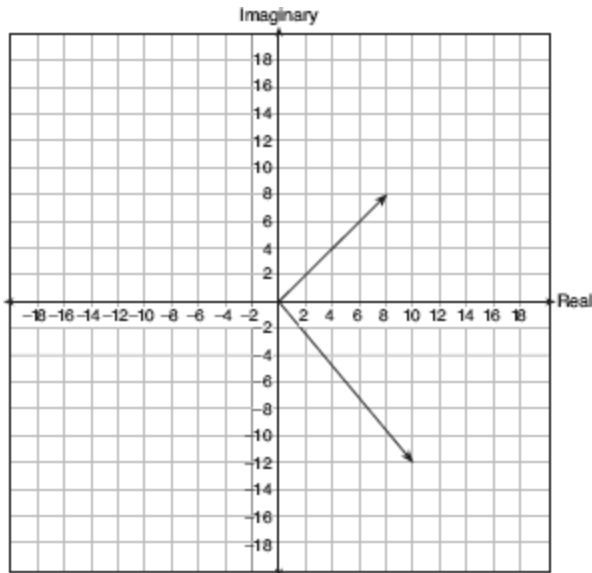

17. Find the sum of $-2 + 3i$ and $-1 - 2i$. Graph the resultant on the accompanying set of axes.

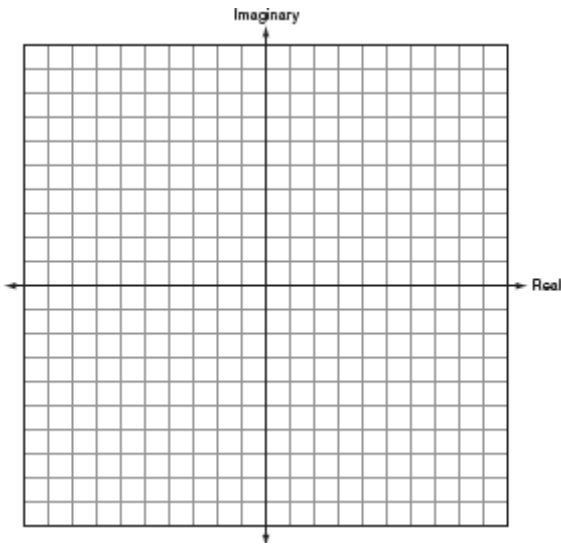

18. On the accompanying set of axes, graphically represent the sum of $3 + 4i$ and $-1 + 2i$.

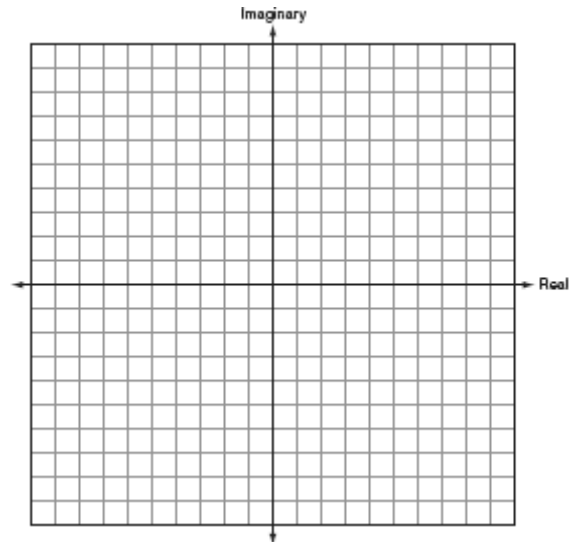

19. Melissa and Joe are playing a game with complex numbers. If Melissa has a score of $5 - 4i$ and Joe has a score of $3 + 2i$, what is their total score?
- [A] $8 - 6i$ [B] $8 + 6i$
 [C] $8 - 2i$ [D] $8 + 2i$
20. Express $\sqrt{-48} + 3.5 + \sqrt{25} + \sqrt{-27}$ in simplest $a + bi$ form.
21. What is the sum of $2 - \sqrt{-4}$ and $-3 + \sqrt{-16}$ expressed in simplest $a + bi$ form?
- [A] $-1 + i\sqrt{20}$ [B] $-1 + 12i$
 [C] $-1 + 2i$ [D] $-14 + i$
22. When expressed as a monomial in terms of i , $2\sqrt{-32} - 5\sqrt{-8}$ is equivalent to
- [A] $18i\sqrt{2}$ [B] $2i\sqrt{2}$
 [C] $2\sqrt{2}i$ [D] $-2i\sqrt{2}$

23. What is the product of $5 + \sqrt{-36}$ and $1 - \sqrt{-49}$, expressed in simplest $a + bi$ form?

- [A] $-37 + 41i$ [B] $47 - 29i$
[C] $5 - 71i$ [D] $47 + 41i$

24. Show that the product of $a + bi$ and its conjugate is a real number.

25. In an electrical circuit, the voltage, E , in volts, the current, I , in amps, and the opposition to the flow of current, called impedance, Z , in ohms, are related by the equation $E = IZ$. A circuit has a current of $(3 + i)$ amps and an impedance of $(-2 + i)$ ohms. Determine the voltage in $a + bi$ form.

26. The relationship between voltage, E , current, I , and resistance, Z , is given by the equation $E = IZ$. If a circuit has a current $I = 3 + 2i$ and a resistance $Z = 2 - i$, what is the voltage of this circuit?

- [A] $4 + i$ [B] $8 + i$ [C] $8 + 7i$ [D] $4 - i$

27. The expression $3i(2i^2 - 5i)$ is equivalent to

- [A] $-15 - 5i$ [B] $-1 + 0i$
[C] $15 - 6i$ [D] $15 - 5i$

28. The complex number $c + di$ is equal to $(2 + i)^2$. What is the value of c ?

29. The expression $(-1 + i)^3$ is equivalent to

- [A] $-3i$ [B] $2 + 2i$
[C] $-1 - i$ [D] $-2 - 2i$

30. If $f(x) = x^3 - 2x^2$, then $f(i)$ is equivalent to

- [A] $2 + i$ [B] $-2 + i$ [C] $2 - i$ [D] $-2 - i$

31. What is the value of x in the equation

$$\sqrt{5 - 2x} = 3i?$$

- [A] 1 [B] 7 [C] 4 [D] -2

32. The expression $\frac{2+i}{3+i}$ is equivalent to

- [A] $\frac{7+i}{10}$ [B] $\frac{7-5i}{10}$
[C] $\frac{6+i}{8}$ [D] $\frac{6+5i}{8}$

33. Impedance measures the opposition of an electrical circuit to the flow of electricity. The total impedance in a particular circuit is given by the formula $Z_T = \frac{Z_1 Z_2}{Z_1 + Z_2}$. What is the total impedance of a circuit, Z_T , if $Z_1 = 1 + 2i$ and $Z_2 = 1 - 2i$?

- [A] $-\frac{3}{2}$ [B] 0 [C] $\frac{5}{2}$ [D] 1

SUMMATIONS

34. Evaluate: $2 \sum_{n=1}^5 (2n - 1)$

35. What is the value of $\sum_{n=1}^5 (-2n + 100)$?

- [A] 530 [B] 130 [C] 470 [D] 70

36. What is the value of $\sum_{m=2}^5 (m^2 - 1)$?

- [A] 58 [B] 50 [C] 53 [D] 54

37. Evaluate: $\sum_{n=1}^5 (n^2 + n)$

38. What is the value of $\sum_{m=1}^3 (2m + 1)^{m-1}$?

- [A] 245 [B] 57 [C] 55 [D] 15

39. The projected total annual profits, in dollars, for the Nutyme Clothing Company from 2002 to 2004 can be approximated by the model $\sum_{n=0}^2 (13,567n + 294)$, where n is the year and $n = 0$ represents 2002. Use this model to find the company's projected total annual profits, in dollars, for the period 2002 to 2004.

40. A ball is dropped from a height of 8 feet and allowed to bounce. Each time the ball bounces, it bounces back to half its previous height. The vertical distance the ball travels, d , is given by the formula $d = 8 + 16 \sum_{k=1}^n \left(\frac{1}{2}\right)^k$, where n is the number of bounces. Based on this formula, what is the total vertical distance that the ball has traveled after four bounces?

- [A] 15.0 ft [B] 23.0 ft
[C] 22.0 ft [D] 8.9 ft

41. Evaluate: $\sum_{k=1}^2 \frac{(-1)^{k-1}}{(2k-1)!}$

42. If ${}_n C_r$ represents the number of combinations of n items taken r at a time, what is the value of $\sum_{r=1}^3 {}_4 C_r$?

- [A] 4 [B] 24 [C] 6 [D] 14

43. The value of $\sum_{r=2}^4 {}_5 C_r$ is

- [A] 45 [B] 25 [C] 10 [D] 5

44. Evaluate: $\sum_{k=0}^3 (3 \cos k\pi + 1)$

45. What is the value of $\sum_{b=0}^3 (2 - (b)i)$?

- [A] 2-6i [B] 8-6i [C] 2-5i [D] 8-5i

46. Jonathan's teacher required him to express the sum $\frac{2}{3} + \frac{3}{4} + \frac{4}{5} + \frac{5}{6} + \frac{6}{7}$ using sigma notation.

Jonathan proposed four possible answers. Which of these four answers is *not* correct?

[A] $\sum_{k=1}^5 \frac{k+1}{k+2}$ [B] $\sum_{k=3}^7 \frac{k-1}{k}$

[C] $\sum_{k=2}^6 \frac{k}{k+1}$ [D] $\sum_{k=1}^5 \frac{k}{k+1}$

47. The expression $1 + \sqrt{2} + \sqrt[3]{3}$ is equivalent to

[A] $\sum_{n=0}^3 n^n$ [B] $\sum_{n=1}^3 n^{-n}$

[C] $\sum_{n=1}^3 \sqrt[n]{n}$ [D] $\sum_{n=1}^3 n^{\frac{1}{n}}$

GRAPHS & STATISTICS

RELATING GRAPHS TO EVENTS

48. A bug travels up a tree, from the ground, over a 30-second interval. It travels fast at first and then slows down. It stops for 10 seconds, then proceeds slowly, speeding up as it goes. Which sketch best illustrates the bug's distance (d) from the ground over the 30-second interval (t)?

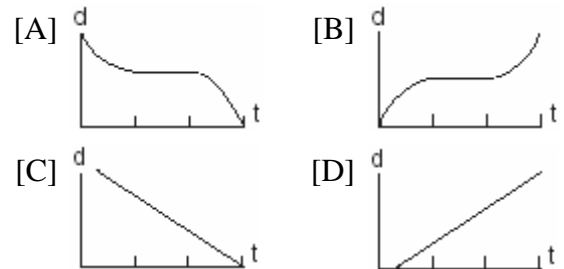

CENTRAL TENDENCY

49. What is the mean of the data in the accompanying table?

Scores (x_i)	Frequency (f_i)
25	3
20	2
11	5
10	4

- [A] 16 [B] 15 [C] 14.5 [D] 11

50. Two social studies classes took the same current events examination that was scored on the basis of 100 points. Mr. Wong's class had a median score of 78 and a range of 4 points, while Ms. Rizzo's class had a median score of 78 and a range of 22 points. Explain how these classes could have the same median score while having very different ranges.

STANDARD DEVIATION

51. Jean's scores on five mathematics tests were 98, 97, 99, 98, and 96. Her scores on five English tests were 78, 84, 95, 72, and 79. Which statement is true about the standard deviations for the scores?

- [A] More information is needed to determine the relationship between the standard deviations.
- [B] The standard deviation for the math scores is greater than the standard deviation for the English scores.
- [C] The standard deviations for both sets of scores are equal.
- [D] The standard deviation for the English scores is greater than the standard deviation for the math scores.

52. On a nationwide examination, the Adams School had a mean score of 875 and a standard deviation of 12. The Boswell School had a mean score of 855 and a standard deviation of 20. In which school was there greater consistency in the scores? Explain how you arrived at your answer.

53. The term “snowstorms of note” applies to all snowfalls over 6 inches. The snowfall amounts for snowstorms of note in Utica, New York, over a four-year period are as follows: 7.1, 9.2, 8.0, 6.1, 14.4, 8.5, 6.1, 6.8, 7.7, 21.5, 6.7, 9.0, 8.4, 7.0, 11.5, 14.1, 9.5, 8.6. What are the mean and population standard deviation for these data, to the *nearest hundredth*?

- [A] mean = 9.46; standard deviation = 3.85
 [B] mean = 9.45; standard deviation = 3.74
 [C] mean = 9.46; standard deviation = 3.74
 [D] mean = 9.45; standard deviation = 3.85

54. The number of children of each of the first 41 United States presidents is given in the accompanying table. For this population, determine the mean and the standard deviation to the *nearest tenth*. How many of these presidents fall within one standard deviation of the mean?

Number of Children (x_i)	Number of Presidents (f_i)
0	6
1	2
2	8
3	6
4	7
5	3
6	5
7	1
8	1
10	1
15	1

55. Conant High School has 17 students on its championship bowling team. Each student bowled one game. The scores are listed in the accompanying table.

Score (x_i)	Frequency (f_i)
140	4
145	3
150	2
160	3
170	2
180	2
194	1

Find, to the *nearest tenth*, the population standard deviation of these scores. How many of the scores fall within one standard deviation of the mean?

56. Mr. Koziol has 17 students in his high school golf club. Each student played one round of golf. The summarized scores of the students are listed in the accompanying table.

Score	Frequency
70	4
73	3
75	2
80	3
85	1
86	1
90	2
92	1

Find the population standard deviation of this set of students' scores, to the *nearest tenth*. How many of the individual students' golf scores fall within one population standard deviation of the mean?

57. Beth's scores on the six Earth science tests she took this semester are 100, 95, 55, 85, 75, and 100. For this population, how many scores are within one standard deviation of the mean?
58. From 1984 to 1995, the winning scores for a golf tournament were 276, 279, 279, 277, 278, 278, 280, 282, 285, 272, 279, and 278. Using the standard deviation for the sample, S_x , find the percent of these winning scores that fall within one standard deviation of the mean.
59. An electronics company produces a headphone set that can be adjusted to accommodate different-sized heads. Research into the distance between the top of people's heads and the top of their ears produced the following data, in inches:
4.5, 4.8, 6.2, 5.5, 5.6, 5.4, 5.8, 6.0, 5.8, 6.2, 4.6, 5.0, 5.4, 5.8
The company decides to design their headphones to accommodate three standard deviations from the mean. Find, to the *nearest tenth*, the mean, the standard deviation, and the range of distances that must be accommodated.
60. On a standardized test, a score of 86 falls exactly 1.5 standard deviations below the mean. If the standard deviation for the test is 2, what is the mean score for this test?
[A] 87.5 [B] 89 [C] 84.5 [D] 84

REGRESSION

61. The accompanying table shows the enrollment of a preschool from 1980 through 2000. Write a linear regression equation to model the data in the table.

Year (x)	Enrollment (y)
1980	14
1985	20
1990	22
1995	28
2000	37

62. The 1999 win-loss statistics for the American League East baseball teams on a particular date is shown in the accompanying chart.

	W	L
New York	52	34
Boston	49	39
Toronto	47	43
Tampa Bay	39	49
Baltimore	36	51

Find the mean for the number of wins, \bar{W} , and the mean for the number of losses, \bar{L} , and determine if the point (\bar{W}, \bar{L}) is a point on the line of best fit. Justify your answer.

63. A real estate agent plans to compare the price of a cottage, y , in a town on the seashore to the number of blocks, x , the cottage is from the beach. The accompanying table shows a random sample of sales and location data. Write a linear regression equation that relates the price of a cottage to its distance from the beach. Use the equation to predict the price of a cottage, to the *nearest dollar*, located three blocks from the beach.

Number of Blocks from the Beach (x)	Price of a Cottage (y)
5	\$132,000
0	\$310,000
4	\$204,000
2	\$238,000
1	\$275,000
7	\$60,800

64. The accompanying table shows the percent of the adult population that married before age 25 in several different years. Using the year as the independent variable, find the linear regression equation. Round the regression coefficients to the *nearest hundredth*. Using the equation found above, estimate the percent of the adult population in the year 2009 that will marry before age 25, and round to the *nearest tenth of a percent*.

Year (x)	Percent (y)
1971	42.4
1976	37.4
1980	37.1
1984	34.1
1989	32.1
1993	28.8
1997	25.7
2000	25.5

65. The availability of leaded gasoline in New York State is decreasing, as shown in the accompanying table.

Year	1984	1988	1992	1996	2000
Gallons Available (in thousands)	150	124	104	76	50

Determine a linear relationship for x (years) versus y (gallons available), based on the data given. The data should be entered using the year and gallons available (in thousands), such as (1984,150).

If this relationship continues, determine the number of gallons of leaded gasoline available in New York State in the year 2005. If this relationship continues, during what year will leaded gasoline first become unavailable in New York State?

66. The accompanying table illustrates the number of movie theaters showing a popular film and the film's weekly gross earnings, in millions of dollars.

Number of Theaters (x)	Gross Earnings (y) (millions of dollars)
443	2.57
455	2.65
493	3.73
530	4.05
569	4.76
657	4.76
723	5.15
1,064	9.35

Write the linear regression equation for this set of data, rounding values to *five decimal places*.

Using this linear regression equation, find the approximate gross earnings, in millions of dollars, generated by 610 theaters. Round your answer to *two decimal places*.

Find the minimum number of theaters that would generate at least 7.65 million dollars in gross earnings in one week.

67. In a mathematics class of ten students, the teacher wanted to determine how a homework grade influenced a student's performance on the subsequent test. The homework grade and subsequent test grade for each student are given in the accompanying table.

Homework Grade (x)	Test Grade (y)
94	98
95	94
92	95
87	89
82	85
80	78
75	73
65	67
50	45
20	40

a Give the equation of the linear regression line for this set of data.

b A new student comes to the class and earns a homework grade of 78. Based on the equation in part *a*, what grade would the teacher predict the student would receive on the subsequent test, to the *nearest integer*?

68. The table below shows the results of an experiment that relates the height at which a ball is dropped, x , to the height of its first bounce, y .

Drop Height (x) (cm)	Bounce Height (y) (cm)
100	26
90	23
80	21
70	18
60	16

Find \bar{x} , the mean of the drop heights.
 Find \bar{y} , the mean of the bounce heights.
 Find the linear regression equation that best fits the data.
 Show that (\bar{x}, \bar{y}) is a point on the line of regression. [The use of the grid is optional.]

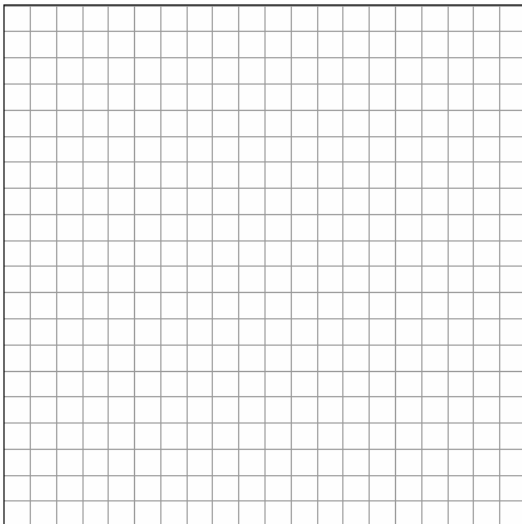

69. Two different tests were designed to measure understanding of a topic. The two tests were given to ten students with the following results:

Test x	75	78	88	92	95	67	58	72	74	81
Test y	81	73	85	88	89	73	66	75	70	78

Construct a scatter plot for these scores, and then write an equation for the line of best fit (round slope and intercept to the *nearest hundredth*).

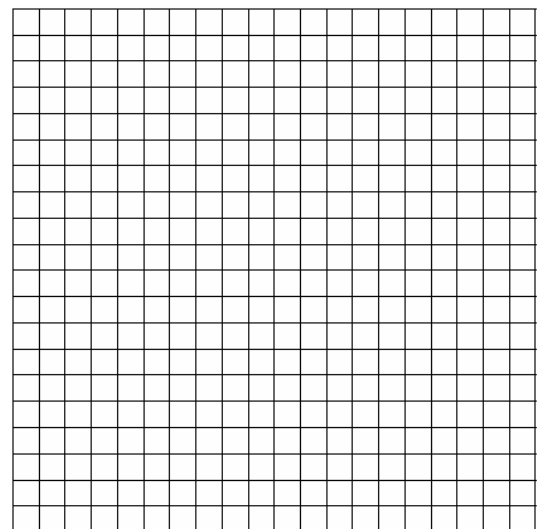

Find the correlation coefficient.
 Predict the score, to the *nearest integer*, on test y for a student who scored 87 on test x .

70. Since 1990, fireworks usage nationwide has grown, as shown in the accompanying table, where t represents the number of years since 1990, and p represents the fireworks usage per year, in millions of pounds.

Number of Years Since 1990 (t)	Fireworks Usage per Year, In Millions of Pounds (p)
0	67.6
2	88.8
4	119.0
6	120.1
7	132.5
8	118.3
9	159.2
11	161.6

Find the equation of the linear regression model for this set of data, where t is the independent variable. Round values to *four decimal places*.

Using this equation, determine in what year fireworks usage would have reached 99 million pounds.

Based on this linear model, how many millions of pounds of fireworks would be used in the year 2008? Round your answer to the *nearest tenth*.

71. A factory is producing and stockpiling metal sheets to be shipped to an automobile manufacturing plant. The factory ships only when there is a minimum of 2,050 sheets in stock. The accompanying table shows the day, x , and the number of sheets in stock, $f(x)$.

Day (x)	Sheets in Stock ($f(x)$)
1	860
2	930
3	1000
4	1150
5	1200
6	1360

Write the linear regression equation for this set of data, rounding the coefficients to *four decimal places*.

Use this equation to determine the day the sheets will be shipped.

72. A box containing 1,000 coins is shaken, and the coins are emptied onto a table. Only the coins that land heads up are returned to the box, and then the process is repeated. The accompanying table shows the number of trials and the number of coins returned to the box after each trial.

Trial	0	1	3	4	6
Coins Returned	1,000	610	220	132	45

Write an exponential regression equation, rounding the calculated values to the *nearest ten-thousandth*.

Use the equation to predict how many coins would be returned to the box after the eighth trial.

73. The table below, created in 1996, shows a history of transit fares from 1955 to 1995. On the accompanying grid, construct a scatter plot where the independent variable is years. State the exponential regression equation with the coefficient and base rounded to the *nearest thousandth*. Using this equation, determine the prediction that should have been made for the year 1998, to the *nearest cent*.

Year	Fare (\$)
55	0.10
60	0.15
65	0.20
70	0.30
75	0.40
80	0.60
85	0.80
90	1.15
95	1.50

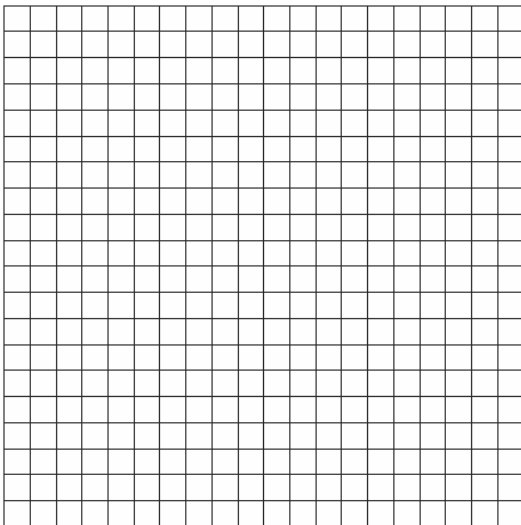

74. The breaking strength, y , in tons, of steel cable with diameter d , in inches, is given in the table below.

d (in)	y (tons)
0.50	9.85
0.75	21.80
1.00	38.30
1.25	59.20
1.50	84.40
1.75	114.00

- On the accompanying grid, make a scatter plot of these data. Write the exponential regression equation, expressing the regression coefficients to the *nearest tenth*.

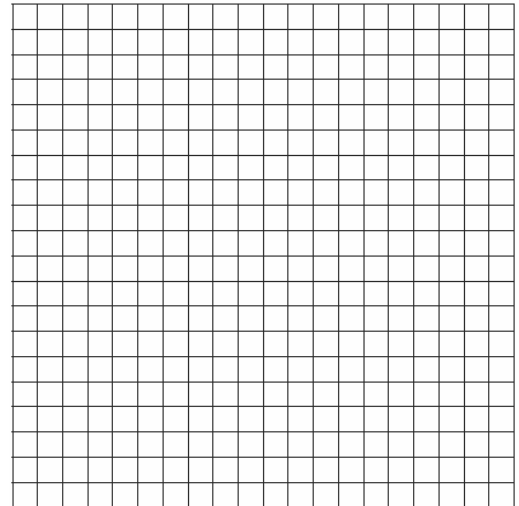

75. The accompanying table shows the average salary of baseball players since 1984. Using the data in the table, create a scatter plot on the grid and state the exponential regression equation with the coefficient and base rounded to the *nearest hundredth*. Using your written regression equation, estimate the salary of a baseball player in the year 2005, to the *nearest thousand dollars*.

Baseball Players' Salaries

Numbers of Years Since 1984	Average Salary (thousands of dollars)
0	290
1	320
2	400
3	495
4	600
5	700
6	820
7	1,000
8	1,250
9	1,580

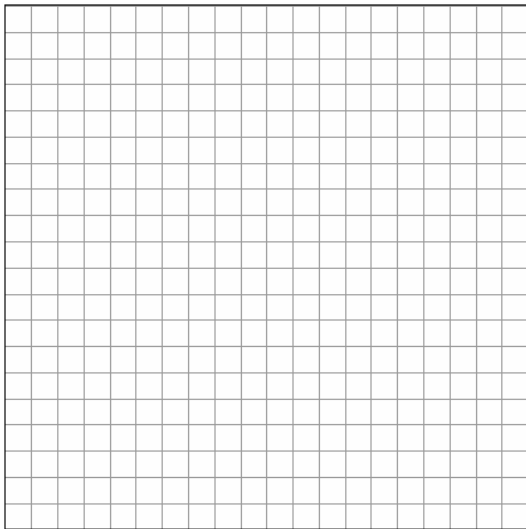

76. Jean invested \$380 in stocks. Over the next 5 years, the value of her investment grew, as shown in the accompanying table.

Years Since Investment (x)	Value of Stock, in Dollars (y)
0	380
1	395
2	411
3	427
4	445
5	462

Write the exponential regression equation for this set of data, rounding all values to *two decimal places*. Using this equation, find the value of her stock, to the *nearest dollar*, 10 years after her initial purchase.

77. What is the equation of a parabola that goes through points (0,1), (-1,6), and (2,3)?
 [A] $y = 2x^2 - 3x + 1$ [B] $y = x^2 - 3x + 1$
 [C] $y = x^2 + 1$ [D] $y = 2x^2 + 1$
78. The accompanying table shows the number of new cases reported by the Nassau and Suffolk County Police Crime Stoppers program for the years 2000 through 2002.

Year (x)	New Cases (y)
2000	457
2001	369
2002	353

If $x = 1$ represents the year 2000, and y represents the number of new cases, find the equation of best fit using a power regression, rounding all values to the *nearest thousandth*. Using this equation, find the estimated number of new cases, to the *nearest whole number*, for the year 2007.

CORRELATION COEFFICIENT

79. A linear regression equation of best fit between a student's attendance and the degree of success in school is $h = 0.5x + 68.5$. The correlation coefficient, r , for these data would be

- [A] $0 < r < 1$ [B] $-1 < r < 0$
[C] $r = 0$ [D] $r = -1$

80. The relationship of a woman's shoe size and length of a woman's foot, in inches, is given in the accompanying table.

Woman's Shoe Size	5	6	7	8
Foot Length (in)	9.00	9.25	9.50	9.75

The linear correlation coefficient for this relationship is

- [A] 0 [B] -1 [C] 1 [D] 0.5

81. Which scatter diagram shows the strongest positive correlation?

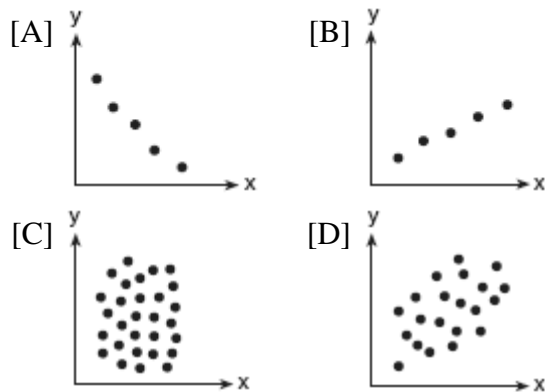

82. Which graph represents data used in a linear regression that produces a correlation coefficient closest to -1 ?

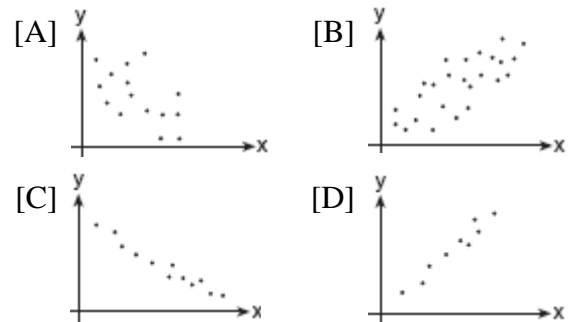

83. What could be the approximate value of the correlation coefficient for the accompanying scatter plot?

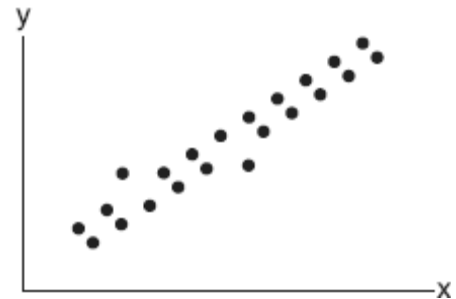

- [A] -0.85 [B] -0.16 [C] 0.90 [D] 0.21

NORMAL DISTRIBUTIONS

84. Twenty high school students took an examination and received the following scores:
70, 60, 75, 68, 85, 86, 78, 72, 82, 88, 88, 73, 74, 79, 86, 82, 90, 92, 93, 73
Determine what percent of the students scored within one standard deviation of the mean. Do the results of the examination approximate a normal distribution? Justify your answer.

85. Mrs. Ramírez is a real estate broker. Last month, the sale prices of homes in her area approximated a normal distribution with a mean of \$150,000 and a standard deviation of \$25,000.
A house had a sale price of \$175,000. What is the percentile rank of its sale price, to the nearest whole number? Explain what that percentile means.
Mrs. Ramírez told a customer that most of the houses sold last month had selling prices between \$125,000 and \$175,000. Explain why she is correct.
86. On a standardized test, the distribution of scores is normal, the mean of the scores is 75, and the standard deviation is 5.8. If a student scored 83, the student's score ranks
- [A] below the 75th percentile
[B] above the 97th percentile
[C] between the 75th percentile and the 84th percentile
[D] between the 84th percentile and the 97th percentile
87. In a New York City high school, a survey revealed the mean amount of cola consumed each week was 12 bottles and the standard deviation was 2.8 bottles. Assuming the survey represents a normal distribution, how many bottles of cola per week will approximately 68.2% of the students drink?
- [A] 6.4 to 12 [B] 12 to 20.4
[C] 9.2 to 14.8 [D] 6.4 to 17.6
88. The amount of juice dispensed from a machine is normally distributed with a mean of 10.50 ounces and a standard deviation of 0.75 ounce. Which interval represents the amount of juice dispensed about 68.2% of the time?
- [A] 9.00-12.00 [B] 9.75-11.25
[C] 10.50-11.25 [D] 9.75-10.50
89. The mean of a normally distributed set of data is 56, and the standard deviation is 5. In which interval do approximately 95.4% of all cases lie?
- [A] 51-61 [B] 46-66
[C] 56-71 [D] 46-56
90. The national mean for verbal scores on an exam was 428 and the standard deviation was 113. Approximately what percent of those taking this test had verbal scores between 315 and 541?
- [A] 26.4% [B] 38.2%
[C] 68.2% [D] 52.8%
91. Battery lifetime is normally distributed for large samples. The mean lifetime is 500 days and the standard deviation is 61 days. Approximately what percent of batteries have lifetimes longer than 561 days?
- [A] 34% [B] 84% [C] 16% [D] 68%
92. The amount of ketchup dispensed from a machine at Hamburger Palace is normally distributed with a mean of 0.9 ounce and a standard deviation of 0.1 ounce. If the machine is used 500 times, approximately how many times will it be expected to dispense 1 or more ounces of ketchup?
- [A] 16 [B] 100 [C] 80 [D] 5
93. Professor Bartrich has 184 students in her mathematics class. The scores on the final examination are normally distributed and have a mean of 72.3 and a standard deviation of 8.9. How many students in the class can be expected to receive a score between 82 and 90?

94. In a certain school district, the ages of all new teachers hired during the last 5 years are normally distributed. Within this curve, 95.4% of the ages, centered about the mean, are between 24.6 and 37.4 years. Find the mean age and the standard deviation of the data.
95. The mean score on a normally distributed exam is 42 with a standard deviation of 12.1. Which score would be expected to occur less than 5% of the time?
- [A] 32 [B] 25 [C] 60 [D] 67

PROBABILITY

NORMAL PROBABILITY

96. A set of normally distributed student test scores has a mean of 80 and a standard deviation of 4. Determine the probability that a randomly selected score will be between 74 and 82.
97. The amount of time that a teenager plays video games in any given week is normally distributed. If a teenager plays video games an average of 15 hours per week, with a standard deviation of 3 hours, what is the probability of a teenager playing video games between 15 and 18 hours a week?
98. A shoe manufacturer collected data regarding men's shoe sizes and found that the distribution of sizes exactly fits the normal curve. If the mean shoe size is 11 and the standard deviation is 1.5, find:
- a* the probability that a man's shoe size is greater than or equal to 11
- b* the probability that a man's shoe size is greater than or equal to 12.5
- c* $\frac{P(\text{size} \geq 12.5)}{P(\text{size} \geq 8)}$

BINOMIAL PROBABILITY

99. The probability that Kyla will score above a 90 on a mathematics test is $\frac{4}{5}$. What is the probability that she will score above a 90 on three of the four tests this quarter?
- [A] ${}_4C_3\left(\frac{4}{5}\right)^3\left(\frac{1}{5}\right)^1$ [B] ${}_4C_3\left(\frac{4}{5}\right)^1\left(\frac{1}{5}\right)^3$
[C] $\frac{3}{4}\left(\frac{4}{5}\right)^3\left(\frac{1}{5}\right)^1$ [D] $\frac{3}{4}\left(\frac{4}{5}\right)^1\left(\frac{1}{5}\right)^3$
100. The Hiking Club plans to go camping in a State park where the probability of rain on any given day is 0.7. Which expression can be used to find the probability that it will rain on *exactly* three of the seven days they are there?
- [A] ${}_4C_3(0.7)^3(0.7)^4$ [B] ${}_7C_3(0.3)^3(0.7)^4$
[C] ${}_4C_3(0.4)^4(0.3)^3$ [D] ${}_7C_3(0.7)^3(0.3)^4$
101. During a single day at radio station WMZH, the probability that a particular song is played is .38. Which expression represents the probability that this song will be played on *exactly* 5 days out of 7 days?
- [A] ${}_5C_2(.38)^5(.62)^2$ [B] ${}_7P_5(.38)^5(.62)^2$
[C] ${}_7C_5(.38)^5(.62)^2$ [D] ${}_7C_5(.38)^2(.62)^5$
102. Which fraction represents the probability of obtaining *exactly* eight heads in ten tosses of a fair coin?
- [A] $\frac{45}{1,024}$ [B] $\frac{90}{1,024}$
[C] $\frac{180}{1,024}$ [D] $\frac{64}{1,024}$

103. At a certain intersection, the light for eastbound traffic is red for 15 seconds, yellow for 5 seconds, and green for 30 seconds. Find, to the *nearest tenth*, the probability that out of the next eight eastbound cars that arrive randomly at the light, exactly three will be stopped by a red light.
104. After studying a couple's family history, a doctor determines that the probability of any child born to this couple having a gene for disease X is 1 out of 4. If the couple has three children, what is the probability that *exactly* two of the children have the gene for disease X ?
105. Mr. and Mrs. Doran have a genetic history such that the probability that a child being born to them with a certain trait is $\frac{1}{8}$. If they have four children, what is the probability that *exactly* three of their four children will have that trait?
106. If the probability that it will rain on any given day this week is 60%, find the probability it will rain *exactly* 3 out of 7 days this week.
107. The Coolidge family's favorite television channels are 3, 6, 7, 10, 11, and 13. If the Coolidge family selects a favorite channel at random to view each night, what is the probability that they choose *exactly* three even-numbered channels in five nights? Express your answer as a fraction or as a decimal rounded to *four decimal places*.
108. During a recent survey, students at Franconia College were asked if they drink coffee in the morning. The results showed that two-thirds of the students drink coffee in the morning and the remainder do not. What is the probability that of six students selected at random, *exactly* two of them drink coffee in the morning? Express your answer as a fraction or as a decimal rounded to *four decimal places*.

109. Ginger and Mary Anne are planning a vacation trip to the island of Capri, where the probability of rain on any day is 0.3. What is the probability that during their five days on the island, they have *no* rain on *exactly* three of the five days?
110. As shown in the accompanying diagram, a circular target with a radius of 9 inches has a bull's-eye that has a radius of 3 inches. If five arrows randomly hit the target, what is the probability that *at least* four hit the bull's-eye?

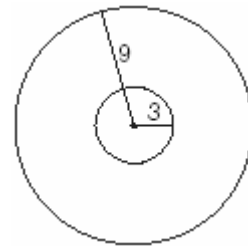

111. Team A and team B are playing in a league. They will play each other five times. If the probability that team A wins a game is $\frac{1}{3}$, what is the probability that team A will win *at least* three of the five games?
112. On any given day, the probability that the entire Watson family eats dinner together is $\frac{2}{5}$. Find the probability that, during any 7-day period, the Watsons eat dinner together *at least* six times.
113. Tim Parker, a star baseball player, hits one home run for every ten times he is at bat. If Parker goes to bat five times during tonight's game, what is the probability that he will hit *at least* four home runs?
114. The probability that a planted watermelon seed will sprout is $\frac{3}{4}$. If Peyton plants seven seeds from a slice of watermelon, find, to the *nearest ten thousandth*, the probability that *at least* five will sprout.

115. On mornings when school is in session in January, Sara notices that her school bus is late one-third of the time. What is the probability that during a 5-day school week in January her bus will be late *at least* three times?
116. A board game has a spinner on a circle that has five equal sectors, numbered 1, 2, 3, 4, and 5, respectively. If a player has four spins, find the probability that the player spins an even number *no more than* two times on those four spins.
117. Dr. Glendon, the school physician in charge of giving sports physicals, has compiled his information and has determined that the probability a student will be on a team is 0.39. Yesterday, Dr. Glendon examined five students chosen at random. Find, to the *nearest hundredth*, the probability that at least four of the five students will be on a team.
Find, to the *nearest hundredth*, the probability that exactly one of the five students will not be on a team.
118. When Joe bowls, he can get a strike (knock down all the pins) 60% of the time. How many times more likely is it for Joe to bowl *at least* three strikes out of four tries as it is for him to bowl zero strikes out of four tries? Round your answer to the *nearest whole number*.

EQUATIONS

TRANSFORMING FORMULAS

119. If $\sqrt{x-a} = b, x > a$, which expression is equivalent to x ?
- [A] $b^2 - a$ [B] $b - a$
[C] $b + a$ [D] $b^2 + a$

120. The volume of any spherical balloon can be found by using the formula $V = \frac{4}{3}\pi r^3$. Write an equation for r in terms of V and π .
121. The slant height, ℓ , of the conical water tank shown in the accompanying diagram is $\ell = \sqrt[3]{\frac{8v}{\pi}}$. Solve for v , in terms of ℓ and π .

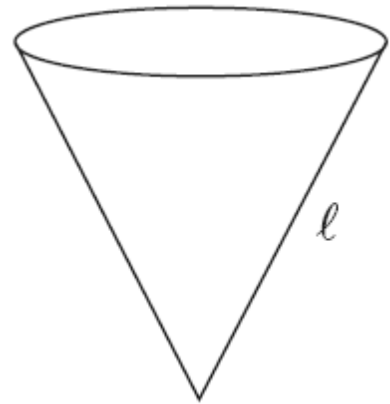

ABSOLUTE VALUE EQUATIONS

122. What is the solution set of the equation $|x^2 - 2x| = 3x - 6$?
- [A] $\{\pm 3\}$ [B] $\{2, \pm 3\}$
[C] $\{2, 3\}$ [D] $\{2\}$

RATE

SPEED

123. Two objects are 2.4×10^{20} centimeters apart. A message from one object travels to the other at a rate of 1.2×10^5 centimeters per second. How many seconds does it take the message to travel from one object to the other?
- [A] 2.0×10^4 [B] 2.88×10^{25}
[C] 1.2×10^{15} [D] 2.0×10^{15}

124. On her first trip, Sari biked 24 miles in T hours. The following week Sari biked 32 miles in T hours. Determine the ratio of her average speed on her second trip to her average speed on her first trip.

- [A] $\frac{3}{4}$ [B] $\frac{2}{3}$ [C] $\frac{3}{2}$ [D] $\frac{4}{3}$

125. On a trip, a student drove 40 miles per hour for 2 hours and then drove 30 miles per hour for 3 hours. What is the student's average rate of speed, in miles per hour, for the whole trip?

- [A] 36 [B] 37 [C] 34 [D] 35

126. If Jamar can run $\frac{3}{5}$ of a mile in 2 minutes 30 seconds, what is his rate in miles per minute?

- [A] $\frac{4}{5}$ [B] $\frac{6}{25}$ [C] $3\frac{1}{10}$ [D] $4\frac{1}{6}$

FUNCTIONS

THREE VIEWS OF A FUNCTION

127. If $f(x) = 4x^0 + (4x)^{-1}$, what is the value of $f(4)$?

- [A] -12 [B] $4\frac{1}{16}$ [C] 0 [D] $1\frac{1}{16}$

128. If $f(x) = (x^{-x} - x^0 + 2^x)$, then $f(3)$ is equal to

- [A] $8\frac{1}{27}$ [B] -22

- [C] -21 [D] $7\frac{1}{27}$

129. The accompanying graph shows the heart rate, in beats per minute, of a jogger during a 4-minute interval.

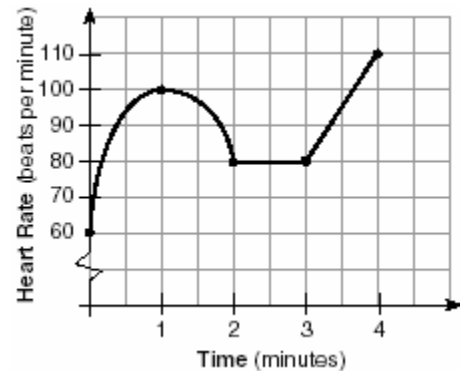

What is the range of the jogger's heart rate during this interval?

- [A] 0-110 [B] 1-4
[C] 0-4 [D] 60-110

130. Data collected during an experiment are shown in the accompanying graph.

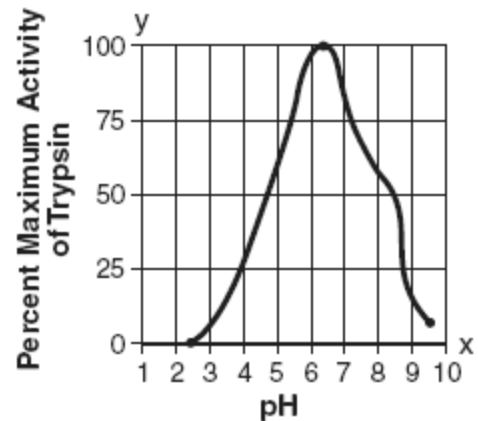

What is the range of this set of data?

- [A] $0 \leq y \leq 100$ [B] $1 \leq x \leq 10$
[C] $2.5 \leq y \leq 9.5$ [D] $2.5 \leq x \leq 9.5$

131. A meteorologist drew the accompanying graph to show the changes in relative humidity during a 24-hour period in New York City.

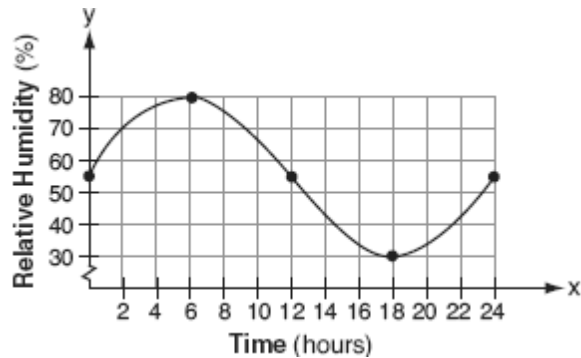

What is the range of this set of data?

- [A] $0 \leq x \leq 24$ [B] $30 \leq x \leq 80$
 [C] $0 \leq y \leq 24$ [D] $30 \leq y \leq 80$
132. The effect of pH on the action of a certain enzyme is shown on the accompanying graph.

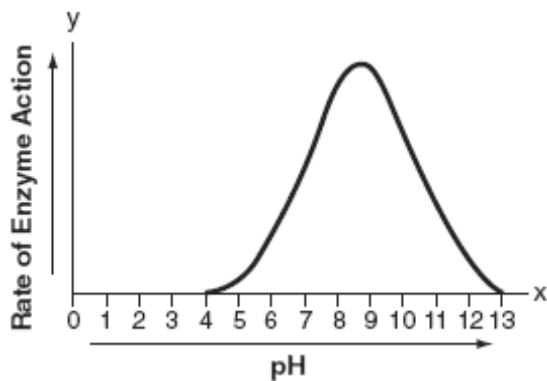

What is the domain of this function?

- [A] $4 \leq y \leq 13$ [B] $y \geq 0$
 [C] $4 \leq x \leq 13$ [D] $x \geq 0$

MODELING RELATIONSHIPS

133. A store advertises that during its Labor Day sale \$15 will be deducted from every purchase over \$100. In addition, after the deduction is taken, the store offers an early-bird discount of 20% to any person who makes a purchase before 10 a.m. If Hakeem makes a purchase of x dollars, $x > 100$, at 8 a.m., what, in terms of x , is the cost of Hakeem's purchase?

- [A] $0.80x - 12$ [B] $0.20x - 3$
 [C] $0.20x - 15$ [D] $0.85x - 20$

DEFINING FUNCTIONS

134. Which graph is *not* a function?

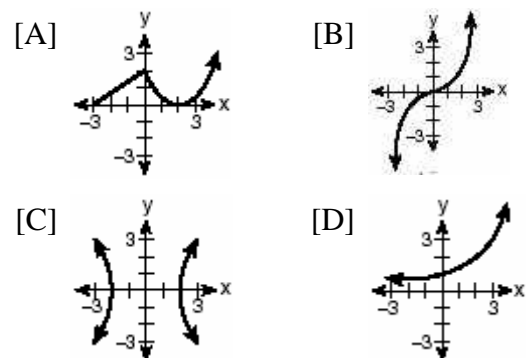

135. Which graph does not represent a function of x ?

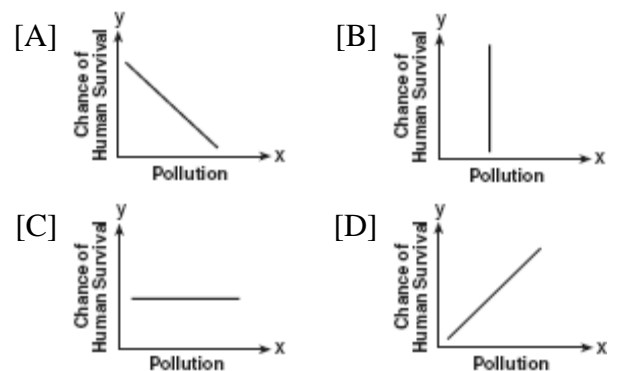

136. Each graph below represents a possible relationship between temperature and pressure. Which graph does *not* represent a function?

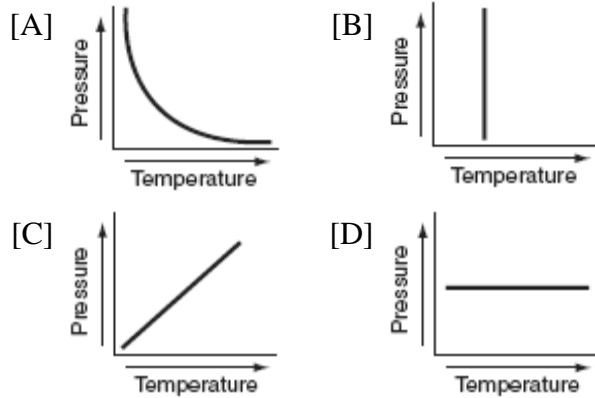

137. Which set of ordered pairs is *not* a function?

- [A] $\{(4,1), (5,1), (6,1), (7,1)\}$
 [B] $\{(1,2), (3,4), (4,5), (5,6)\}$
 [C] $\{(3,1), (2,1), (1,2), (3,2)\}$
 [D] $\{(0,0), (1,1), (2,2), (3,3)\}$

138. Which set of ordered pairs does *not* represent a function?

- [A] $\{(3,-2), (4,-3), (5,-4), (6,-5)\}$
 [B] $\{(3,-2), (-2,3), (4,-1), (-1,4)\}$
 [C] $\{(3,-2), (5,-2), (4,-2), (-1,-2)\}$
 [D] $\{(3,-2), (3,-4), (4,-1), (4,-3)\}$

139. Which relation is *not* a function?

- [A] $y = 2x + 4$ [B] $y = x^2 - 4x + 3$
 [C] $x = 3y - 2$ [D] $x = y^2 + 2x - 3$

140. Which equation does *not* represent a function?

- [A] $y = 4$ [B] $y = x^2 + 5x$
 [C] $x = \pi$ [D] $y = |x|$

141. On the accompanying diagram, draw a mapping of a relation from set A to set B that is *not* a function. Explain why the relationship you drew is *not* a function.

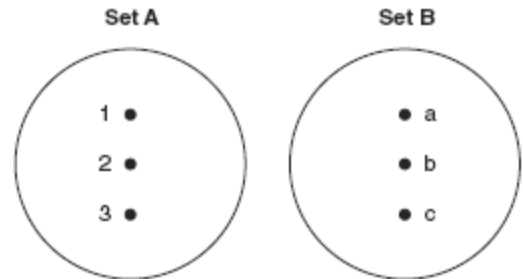

142. Which relation is a function?

- [A] $y = \sin x$ [B] $x = y^2 + 1$
 [C] $x = 4$ [D] $x^2 + y^2 = 16$

143. Which equation represents a function?

- [A] $y = x^2 - 3x - 4$ [B] $x = y^2 - 6x + 8$
 [C] $x^2 + y^2 = 4$ [D] $4y^2 = 36 - 9x^2$

144. Which relation is a function?

- [A] $x = 7$ [B] $x^2 + y^2 = 7$
 [C] $xy = 7$ [D] $x^2 - y^2 = 7$

145. Which diagram represents a relation in which each member of the domain corresponds to only one member of its range?

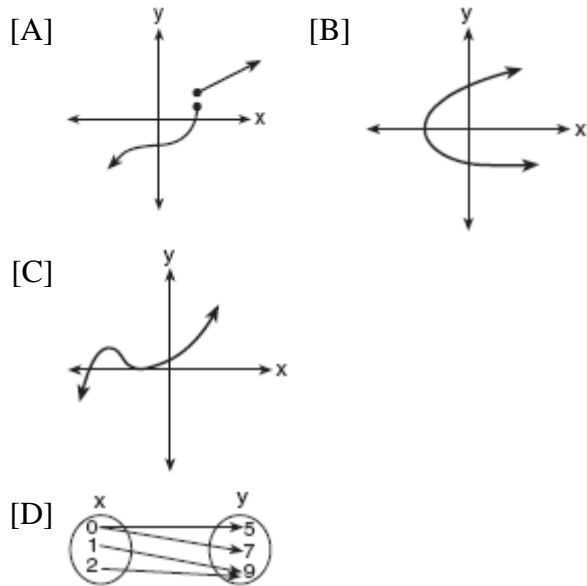

146. Which diagram represents a one-to-one function?

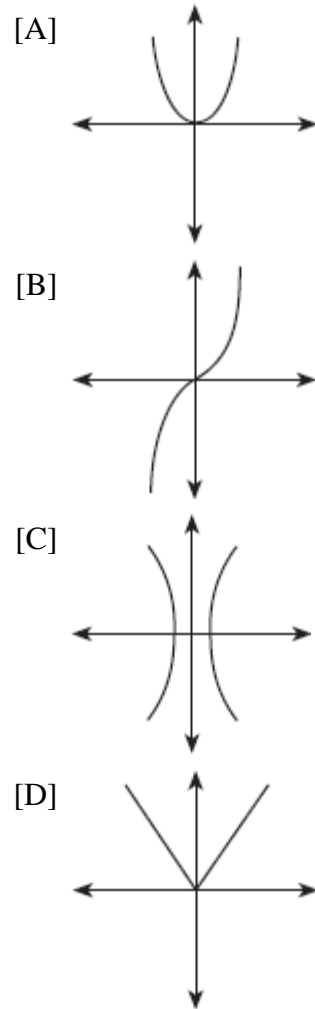

COMPOSITIONS OF FUNCTIONS

147. If $f(x) = -2x + 7$ and $g(x) = x^2 - 2$, then $f(g(3))$ is equal to

- [A] -1 [B] -3 [C] -7 [D] 7

148. If $f(x) = 5x^2 - 1$ and $g(x) = 3x - 1$, find $g(f(1))$.

149. If $f(x) = 2^x - 1$ and $g(x) = x^2 - 1$, determine the value of $(f \circ g)(3)$.

161. The cost (C) of selling x calculators in a store is modeled by the equation $C = \frac{3,200,000}{x} + 60,000$. The store profit (P) for these sales is modeled by the equation $P = 500x$. What is the minimum number of calculators that have to be sold for profit to be greater than cost?

162. A company calculates its profit by finding the difference between revenue and cost. The cost function of producing x hammers is $C(x) = 4x + 170$. If each hammer is sold for \$10, the revenue function for selling x hammers is $R(x) = 10x$.
How many hammers must be sold to make a profit?
How many hammers must be sold to make a profit of \$100?

165. A function is defined by the equation $y = \frac{1}{2}x - \frac{3}{2}$. Which equation defines the inverse of this function?

[A] $y = 2x - \frac{3}{2}$ [B] $y = 2x + \frac{3}{2}$
[C] $y = 2x - 3$ [D] $y = 2x + 3$

166. Given: $f(x) = x^2$ and $g(x) = 2^x$
a The inverse of g is a function, but the inverse of f is not a function. Explain why this statement is true.
b Find $g^{-1}(f(3))$ to the nearest tenth.

167. If the point (a, b) lies on the graph $y = f(x)$, the graph of $y = f^{-1}(x)$ must contain point
- [A] (b, a) [B] $(0, b)$
[C] $(-a, -b)$ [D] $(a, 0)$

INVERSE OF FUNCTIONS

163. If a function is defined by the equation $y = 3x + 2$, which equation defines the inverse of this function?

[A] $y = -3x - 2$ [B] $y = \frac{1}{3}x + \frac{1}{2}$
[C] $y = \frac{1}{3}x - \frac{2}{3}$ [D] $x = \frac{1}{3}y + \frac{1}{2}$

164. A function is defined by the equation $y = 5x - 5$. Which equation defines the inverse of this function?

[A] $y = \frac{1}{5x - 5}$ [B] $x = 5y - 5$
[C] $y = 5x + 5$ [D] $x = \frac{1}{5y - 5}$

168. Which graph represents the inverse of $f(x) = \{(0,1),(1,4),(2,3)\}$?

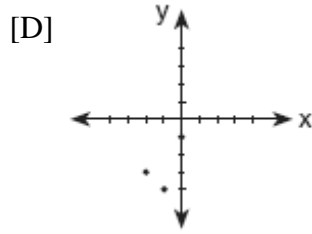
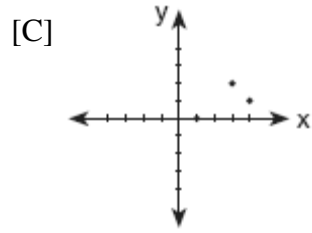
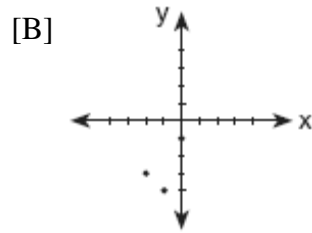
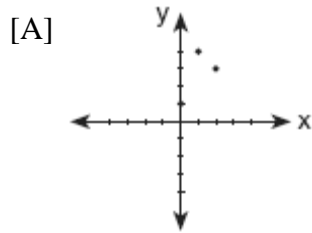

169. Draw $f(x) = 2x^2$ and $f^{-1}(x)$ in the interval $0 \leq x \leq 2$ on the accompanying set of axes. State the coordinates of the points of intersection.

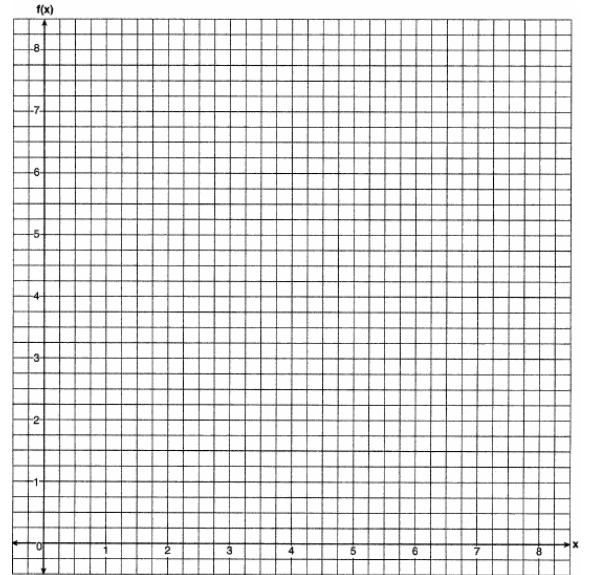

170. The accompanying diagram shows the graph of the line whose equation is $y = -\frac{1}{3}x + 2$. On the same set of axes, sketch the graph of the inverse of this function. State the coordinates of a point on the inverse function.

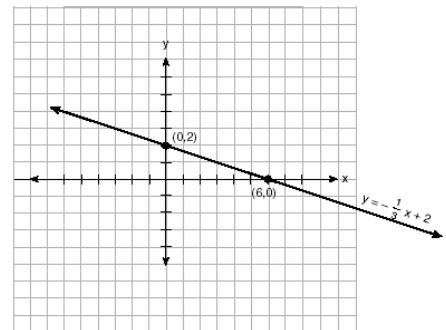

171. Which graph has an inverse that is a function?

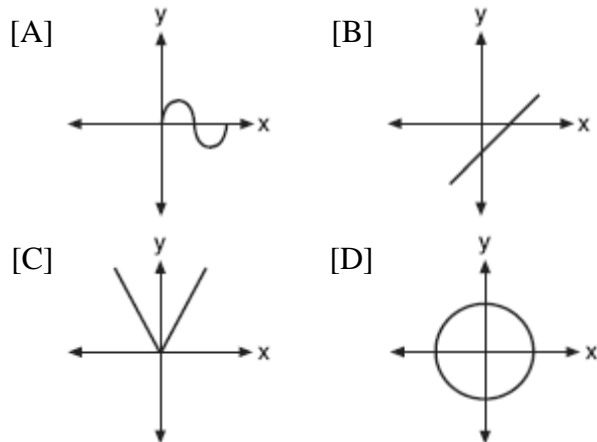

172. What is the inverse of the function $y = \log_4 x$?

- [A] $x^4 = y$ [B] $y^4 = x$
[C] $4^y = x$ [D] $4^x = y$

173. The inverse of a function is a logarithmic function in the form $y = \log_b x$. Which equation represents the original function?

- [A] $y = bx$ [B] $x = b^y$
[C] $by = x$ [D] $y = b^x$

SYSTEMS

WRITING LINEAR SYSTEMS

174. At the local video rental store, José rents two movies and three games for a total of \$15.50. At the same time, Meg rents three movies and one game for a total of \$12.05. How much money is needed to rent a combination of one game and one movie?

175. The cost of a long-distance telephone call is determined by a flat fee for the first 5 minutes and a fixed amount for each additional minute. If a 15-minute telephone call costs \$3.25 and a 23-minute call costs \$5.17, find the cost of a 30-minute call.

BREAK EVEN

176. A cellular telephone company has two plans. Plan A charges \$11 a month and \$0.21 per minute. Plan B charges \$20 a month and \$0.10 per minute. After how much time, to the nearest minute, will the cost of plan A be equal to the cost of plan B?

- [A] 81 hr 48 min [B] 1 hr 36 min
[C] 81 hr 8 min [D] 1 hr 22 m

177. Island Rent-a-Car charges a car rental fee of \$40 plus \$5 per hour or fraction of an hour. Wayne's Wheels charges a car rental fee of \$25 plus \$7.50 per hour or fraction of an hour. Under what conditions does it cost less to rent from Island Rent-a-Car? [The use of the accompanying grid is optional.]

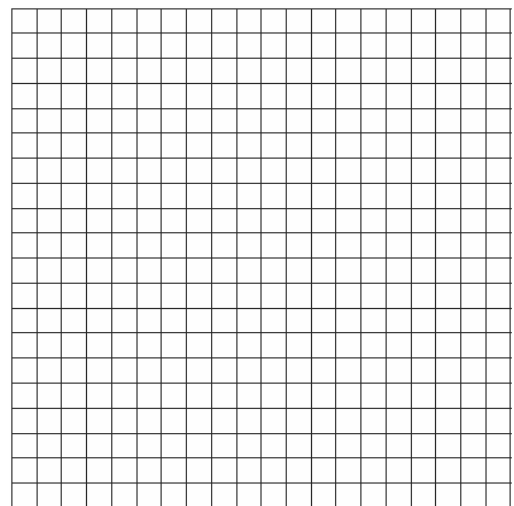

SOLVING NONLINEAR SYSTEMS

178. A pelican flying in the air over water drops a crab from a height of 30 feet. The distance the crab is from the water as it falls can be represented by the function $h(t) = -16t^2 + 30$, where t is time, in seconds. To catch the crab as it falls, a gull flies along a path represented by the function $g(t) = -8t + 15$. Can the gull catch the crab before the crab hits the water? Justify your answer. [The use of the accompanying grid is optional.]

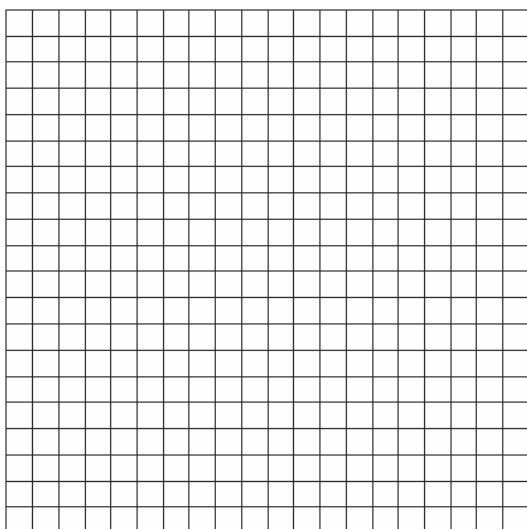

179. The price of a stock, $A(x)$, over a 12-month period decreased and then increased according to the equation $A(x) = 0.75x^2 - 6x + 20$, where x equals the number of months. The price of another stock, $B(x)$, increased according to the equation $B(x) = 2.75x + 1.50$ over the same 12-month period. Graph and label both equations on the accompanying grid. State all prices, to the *nearest dollar*, when both stock values were the same.

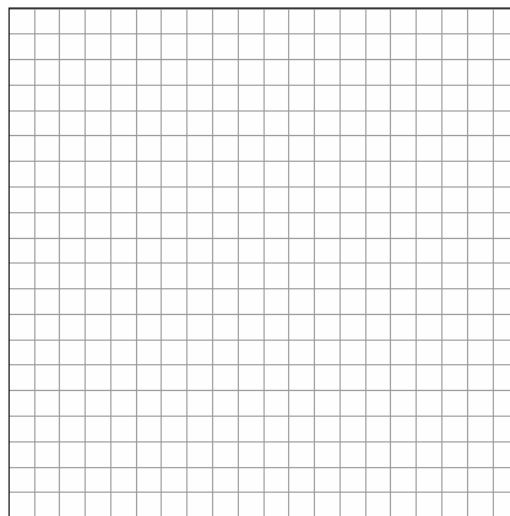

180. Two circles whose equations are $(x-3)^2 + (y-5)^2 = 25$ and $(x-7)^2 + (y-5)^2 = 9$ intersect in two points. What is the equation of the line passing through these two points? [The use of the accompanying grid is optional.]

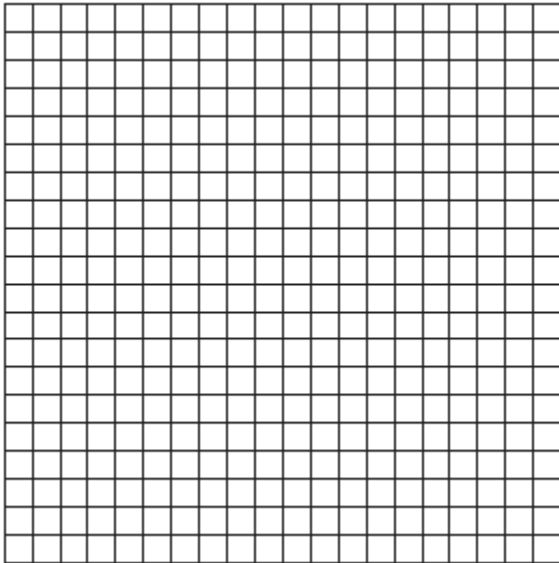

181. Solve the following system of equations algebraically:

$$9x^2 + y^2 = 9$$

$$3x - y = 3$$

182. What is the total number of points of intersection for the graphs of the equations $y = x^2$ and $y = -x^2$?

[A] 1 [B] 2 [C] 0 [D] 3

183. What is one solution of the accompanying system of equations?

$$y = -x^2 + 5$$

$$y = -0.5x^2 + 3$$

[A] (3,5) [B] (0,3)
[C] (-2,1) [D] (0,5)

184. What is the total number of points of intersection of the graphs of the equations $xy = 12$ and $y = -x^2 + 3$?

[A] 1 [B] 2 [C] 4 [D] 3

185. The graphs of the equations $y = 2^x$ and $y = -2x + a$ intersect in Quadrant I for which values of a ?

[A] $a > 1$ [B] $a < 1$
[C] $a \geq 1$ [D] $0 < a < 1$

186. The flight paths of two Thunderbird jets are plotted on a Cartesian coordinate plane, and the equations of the jets' flight paths are represented by $y = 2^x + 3$ and $y = 0.5^x$. The best approximation of the intersection of the flight paths is

[A] (-1.50, 2.82) [B] (0, 1)
[C] (-1.72, 3.3) [D] (-2, -1)

187. On the accompanying grid, sketch the graphs of $y = 2^x$ and $3y = 7x + 3$ over the interval $-3 \leq x \leq 4$. Identify and state the coordinates of all points of intersection.

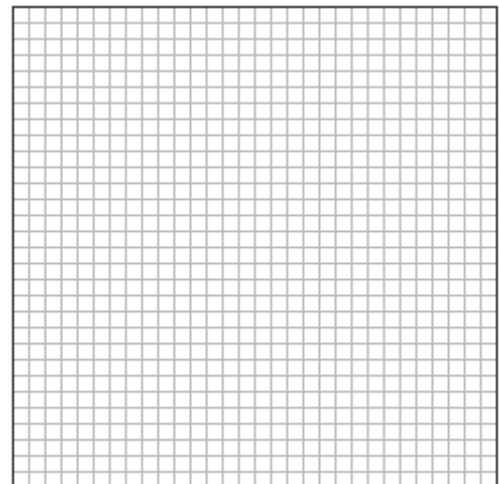

188. On the accompanying grid, solve the following system of equations graphically:

$$y = -x^2 + 2x + 1$$

$$y = 2^x$$

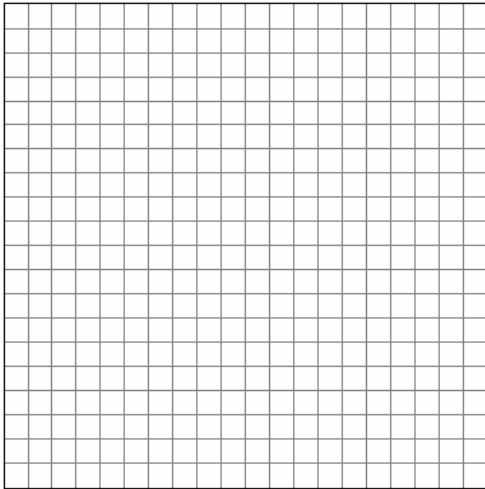

189. The path of a rocket is represented by the equation $y = \sqrt{25 - x^2}$. The path of a missile designed to intersect the path of the rocket is represented by the equation $x = \frac{3}{2}\sqrt{y}$. The value of x at the point of intersection is 3. What is the corresponding value of y ?

- [A] 2 [B] 4 [C] -4 [D] -2

190. A pair of figure skaters graphed part of their routine on a grid. The male skater's path is represented by the equation $m(x) = 3 \sin \frac{1}{2}x$, and the female skater's path is represented by the equation $f(x) = -2 \cos x$. On the accompanying grid, sketch both paths and state how many times the paths of the skaters intersect between $x = 0$ and $x = 4\pi$.

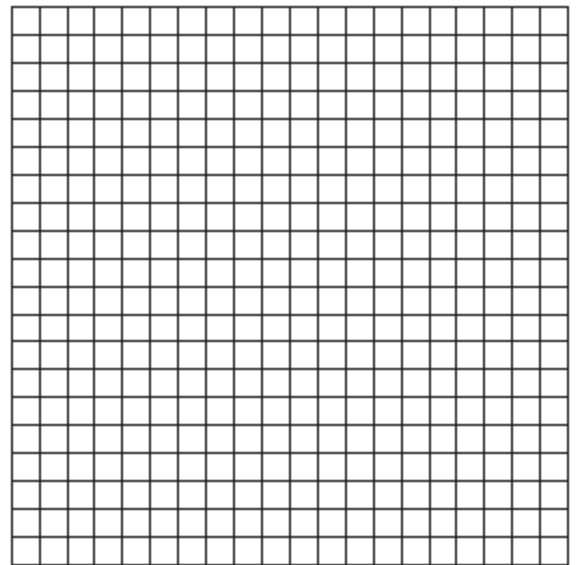

191. On a monitor, the graphs of two impulses are recorded on the same screen, where $0^\circ \leq x < 360^\circ$. The impulses are given by the following equations:

$$y = 2 \sin^2 x$$

$$y = 1 - \sin x$$

Find all values of x , in degrees, for which the two impulses meet in the interval $0^\circ \leq x < 360^\circ$. [Only an algebraic solution will be accepted.]

INEQUALITIES

ABSOLUTE VALUE INEQUALITIES

192. Which equation states that the temperature, t , in a room is less than 3° from 68° ?

- [A] $|68 + t| < 3$ [B] $|68 - t| < 3$
[C] $|3 - t| < 68$ [D] $|3 + t| < 68$

193. The solution set of $|3x + 2| < 1$ contains

- [A] both positive and negative real numbers
[B] only negative real numbers
[C] only positive real numbers
[D] no real numbers

194. What is the solution set of the inequality $|3 - 2x| \geq 4$?

- [A] $\{x | -\frac{1}{2} \leq x \leq \frac{7}{2}\}$
[B] $\{x | x \leq -\frac{1}{2} \text{ or } x \geq \frac{7}{2}\}$
[C] $\{x | x \leq \frac{7}{2} \text{ or } x \geq \frac{1}{2}\}$
[D] $\{x | \frac{7}{2} \leq x \leq -\frac{1}{2}\}$

195. What is the solution of the inequality $|x + 3| \leq 5$?

- [A] $x \leq -8$ or $x \geq 2$ [B] $-8 \leq x \leq 2$
[C] $-2 \leq x \leq 8$ [D] $x \leq -2$ or $x \geq 8$

196. The solution of $|2x - 3| < 5$ is

- [A] $x < 4$ [B] $-1 < x < 4$
[C] $x > -1$ [D] $x < -1$ or $x > 4$

197. What is the solution of the inequality $|y + 8| > 3$?

- [A] $-11 < y < -5$ [B] $y > -5$ or $y < -11$
[C] $-5 < y < 11$ [D] $y > -5$

198. What is the solution set of the inequality $|2x - 1| < 9$?

- [A] $\{x | x < -4\}$ [B] $\{x | x < -4$ or $x > 5\}$
[C] $\{x | -4 < x < 5\}$ [D] $\{x | x < 5\}$

199. Which graph represents the solution set of $|2x - 1| < 7$?

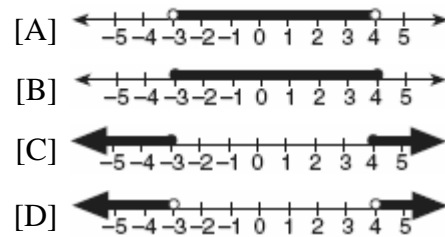

200. Which graph represents the solution set for the expression $|2x + 3| > 7$?

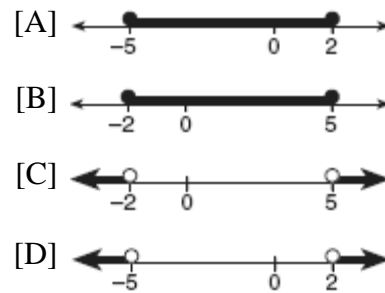

201. Which inequality is represented by the accompanying graph?



- [A] $|x + 3| \geq 2$ [B] $|x - 5| \geq 2$
[C] $|x + 2| > 5$ [D] $|x - 1| \leq 5$

202. The solution set of which inequality is represented by the accompanying graph?

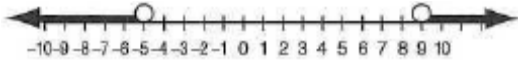

- [A] $|x - 2| < 7$ [B] $|x - 2| > 7$
[C] $|2 - x| > -7$ [D] $|2 - x| < -7$

203. The inequality $|1.5C - 24| \leq 30$ represents the range of monthly average temperatures, C , in degrees Celsius, for Toledo, Ohio. Solve for C .

204. The heights, h , of the students in the chorus at Central Middle School satisfy the inequality $\left| \frac{h - 57.5}{2} \right| \leq 3.25$, when h is measured in inches. Determine the interval in which these heights lie and express your answer to the nearest tenth of a foot. [Only an algebraic solution can receive full credit.]

205. A depth finder shows that the water in a certain place is 620 feet deep. The difference between d , the actual depth of the water, and the reading is $|d - 620|$ and must be less than or equal to $0.05d$. Find the minimum and maximum values of d , to the nearest tenth of a foot.

QUADRATIC INEQUALITIES

206. Which graph represents the solution set of the inequality $x^2 - 4x - 5 < 0$?

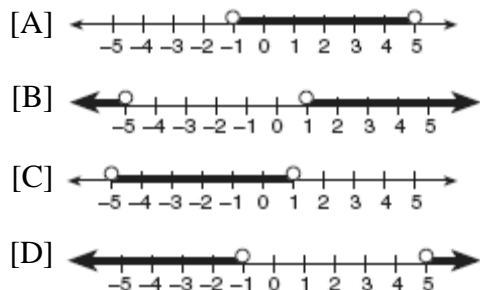

207. Which graph represents the solution set of $x^2 - x - 12 < 0$?

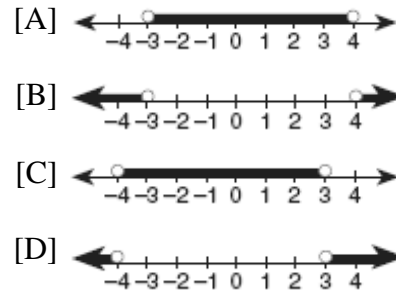

208. What is the solution set of the inequality $x^2 + 4x - 5 < 0$?

- [A] $\{x | -1 < x < 5\}$ [B] $\{x | -5 < x < 1\}$
[C] $\{x | x < -5 \text{ or } x > 1\}$
[D] $\{x | x < -1 \text{ or } x > 5\}$

209. When a baseball is hit by a batter, the height of the ball, $h(t)$, at time t , $t \geq 0$, is determined by the equation $h(t) = -16t^2 + 64t + 4$. For which interval of time is the height of the ball greater than or equal to 52 feet?

210. The height of a projectile is modeled by the equation $y = -2x^2 + 38x + 10$, where x is time, in seconds, and y is height, in feet. During what interval of time, to the *nearest tenth of a second*, is the projectile *at least* 125 feet above ground? [The use of the accompanying grid is optional.]

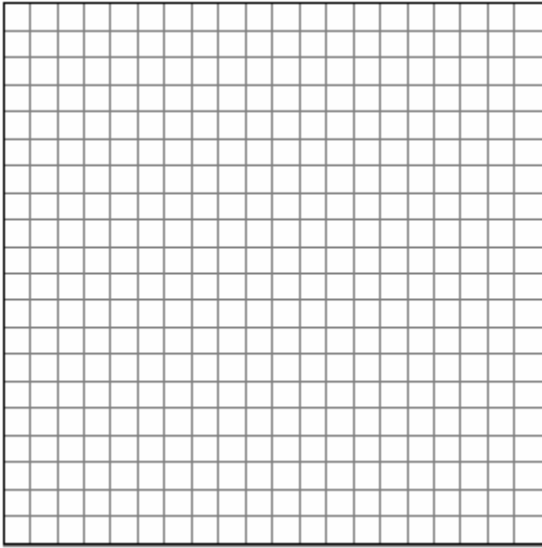

212. The profit, P , for manufacturing a wireless device is given by the equation $P = -10x^2 + 750x - 9,000$, where x is the selling price, in dollars, for each wireless device. What range of selling prices allows the manufacturer to make a profit on this wireless device? [The use of the grid is optional.]

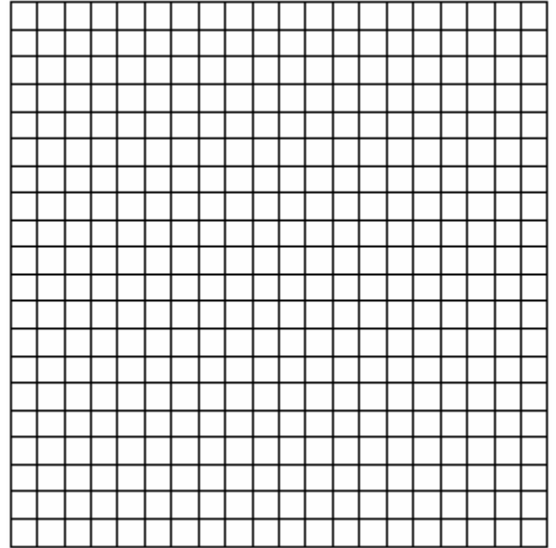

211. The profit a coat manufacturer makes each day is modeled by the equation $P(x) = -x^2 + 120x - 2000$, where P is the profit and x is the price for each coat sold. For what values of x does the company make a profit? [The use of the accompanying grid is optional.]

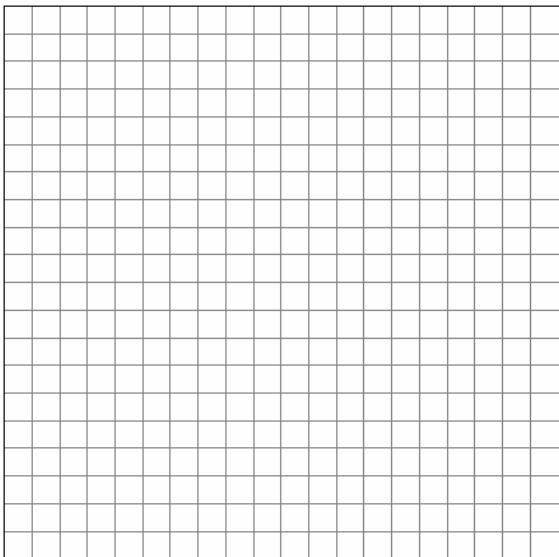

TRIGONOMETRIC INEQUALITIES

213. A building's temperature, T , varies with time of day, t , during the course of 1 day, as follows:

$$T = 8 \cos t + 78$$

The air-conditioning operates when $T \geq 80^\circ F$. Graph this function for $6 \leq t < 17$ and determine, to the *nearest tenth of an hour*, the amount of time in 1 day that the air-conditioning is on in the building.

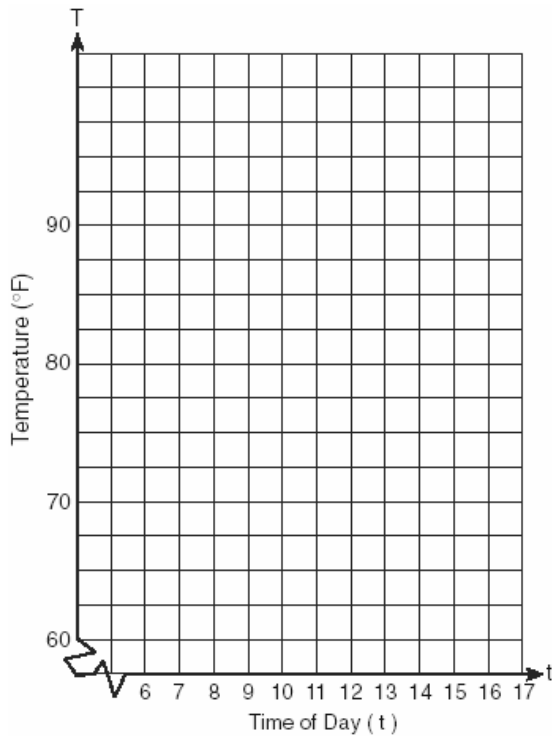

214. The tide at a boat dock can be modeled by the equation $y = -2 \cos\left(\frac{\pi}{6}t\right) + 8$, where t is the number of hours past noon and y is the height of the tide, in feet. For how many hours between $t = 0$ and $t = 12$ is the tide at least 7 feet? [The use of the grid is optional.]

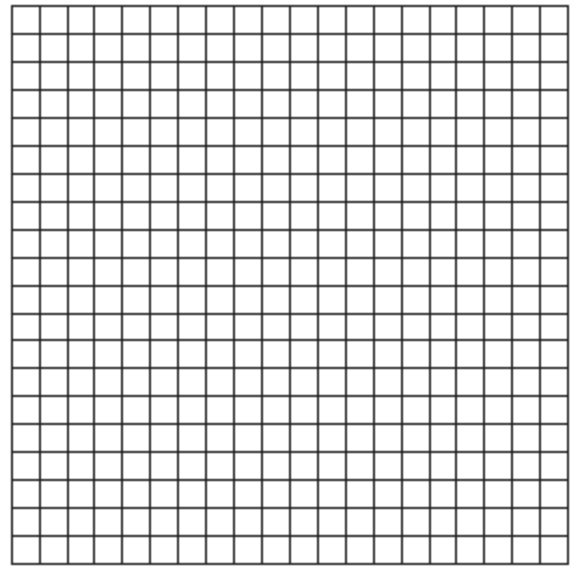

215. On the accompanying set of axes, graph the equations $y = 4 \cos x$ and $y = 2$ in the domain $-\pi \leq x \leq \pi$. Express, in terms of π , the interval for which $4 \cos x \geq 2$.

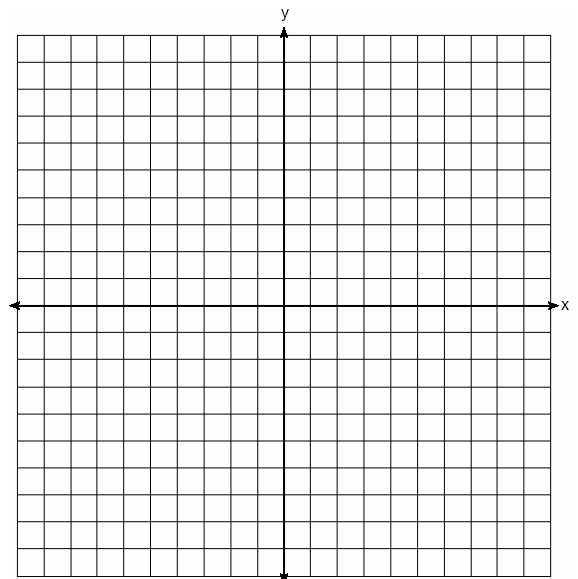

QUADRATICS

SOLVING QUADRATICS BY FACTORING

216. If the equation $x^2 - kx - 36 = 0$ has $x = 12$ as one root, what is the value of k ?
- [A] -3 [B] -9 [C] 3 [D] 9

QUADRATIC FUNCTIONS

217. Which quadratic function is shown in the accompanying graph?

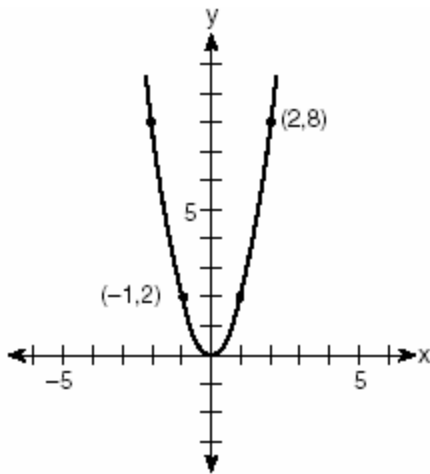

- [A] $y = -2x^2$ [B] $y = 2x^2$
 [C] $y = -\frac{1}{2}x^2$ [D] $y = \frac{1}{2}x^2$

218. Which equation represents the parabola shown in the accompanying graph?

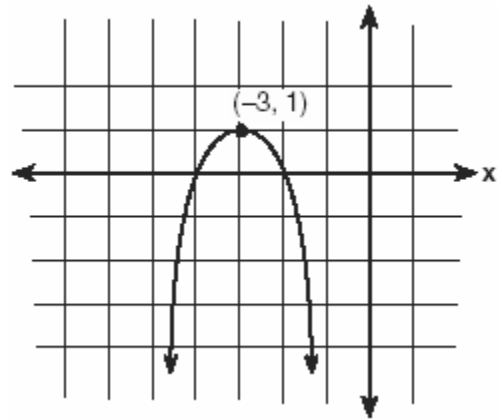

- [A] $f(x) = -(x-3)^2 - 3$
 [B] $f(x) = -(x+3)^2 + 1$
 [C] $f(x) = -(x-3)^2 + 1$
 [D] $f(x) = (x+1)^2 - 3$

219. Which equation is best represented by the accompanying graph?

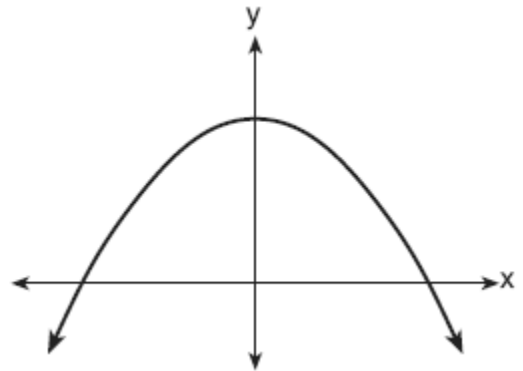

- [A] $y = 6x^2$ [B] $y = -x^2 + 1$
 [C] $y = 6^x$ [D] $y = 6x + 1$

220. For which quadratic equation is the axis of symmetry $x = 3$?

- [A] $y = -x^2 + 3x + 5$ [B] $y = x^2 + 6x + 3$
 [C] $y = x^2 + x + 3$ [D] $y = -x^2 + 6x + 2$

221. The graph of $y = (x - 3)^2$ is shifted left 4 units and down 2 units. What is the axis of symmetry of the transformed graph?
- [A] $x = 7$ [B] $x = -2$
[C] $x = -1$ [D] $x = 1$
222. A small rocket is launched from a height of 72 feet. The height of the rocket in feet, h , is represented by the equation $h(t) = -16t^2 + 64t + 72$, where $t =$ time, in seconds. Graph this equation on the accompanying grid. Use your graph to determine the number of seconds that the rocket will remain at or above 100 feet from the ground. [Only a graphic solution can receive full credit.]

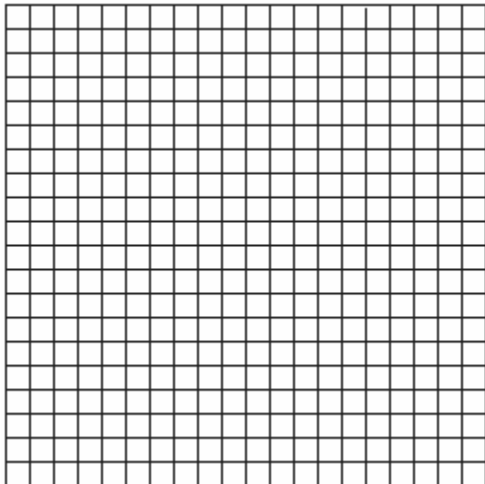

223. An acorn falls from the branch of a tree to the ground 25 feet below. The distance, S , the acorn is from the ground as it falls is represented by the equation $S(t) = -16t^2 + 25$, where t represents time, in seconds. Sketch a graph of this situation on the accompanying grid. Calculate, to the *nearest hundredth of a second*, the time the acorn will take to reach the ground.

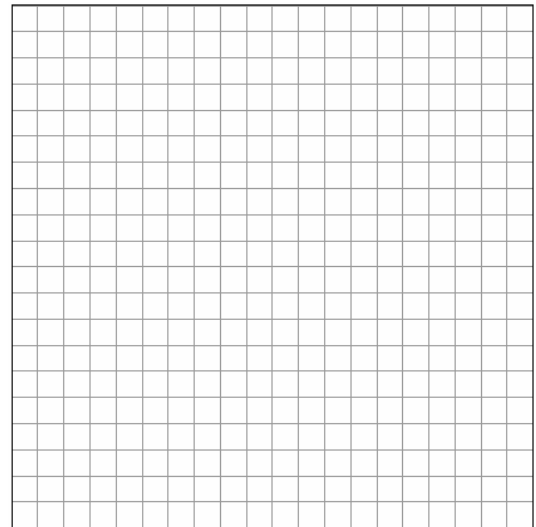

MINIMUM AND MAXIMUM OF QUADRATICS

224. What is the turning point, or vertex, of the parabola whose equation is $y = 3x^2 + 6x - 1$?
- [A] (-1,-4) [B] (-3,8)
[C] (1,8) [D] (3,44)
225. What is the minimum point of the graph of the equation $y = 2x^2 + 8x + 9$?
- [A] (2,33) [B] (-2,1)
[C] (-2,-15) [D] (2,17)

226. An archer shoots an arrow into the air such that its height at any time, t , is given by the function $h(t) = -16t^2 + kt + 3$. If the maximum height of the arrow occurs at time $t = 4$, what is the value of k ?
- [A] 8 [B] 128 [C] 64 [D] 4
227. The height of an object, $h(t)$, is determined by the formula $h(t) = -16t^2 + 256t$, where t is time, in seconds. Will the object reach a maximum or a minimum? Explain or show your reasoning.
228. Vanessa throws a tennis ball in the air. The function $h(t) = -16t^2 + 45t + 7$ represents the distance, in feet, that the ball is from the ground at any time t . At what time, to the nearest tenth of a second, is the ball at its maximum height?
229. The height, h , in feet, a ball will reach when thrown in the air is a function of time, t , in seconds, given by the equation $h(t) = -16t^2 + 30t + 6$. Find, to the nearest tenth, the maximum height, in feet, the ball will reach.
230. When a current, I , flows through a given electrical circuit, the power, W , of the circuit can be determined by the formula $W = 120I - 12I^2$. What amount of current, I , supplies the maximum power, W ?
231. The equation $W = 120I - 12I^2$ represents the power (W), in watts, of a 120-volt circuit having a resistance of 12 ohms when a current (I) is flowing through the circuit. What is the maximum power, in watts, that can be delivered in this circuit?

232. A baseball player throws a ball from the outfield toward home plate. The ball's height above the ground is modeled by the equation $y = -16x^2 + 48x + 6$ where y represents height, in feet, and x represents time, in seconds. The ball is initially thrown from a height of 6 feet. How many seconds after the ball is thrown will it again be 6 feet above the ground? What is the maximum height, in feet, that the ball reaches? [The use of the accompanying grid is optional.]

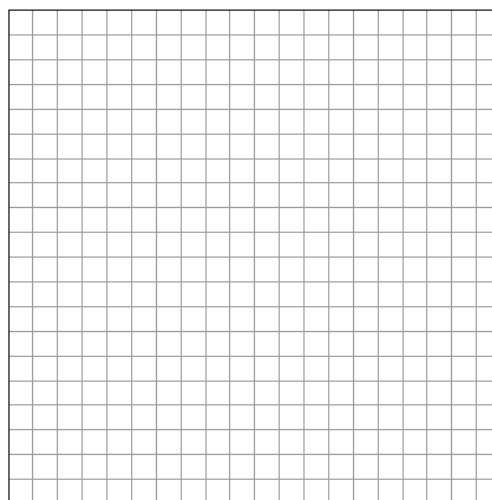

233. A rock is thrown vertically from the ground with a velocity of 24 meters per second, and it reaches a height of $2 + 24t - 4.9t^2$ after t seconds. How many seconds after the rock is thrown will it reach maximum height, and what is the maximum height the rock will reach, in meters? How many seconds after the rock is thrown will it hit the ground? Round your answers to the *nearest hundredth*. [Only an algebraic or graphic solution will be accepted.]

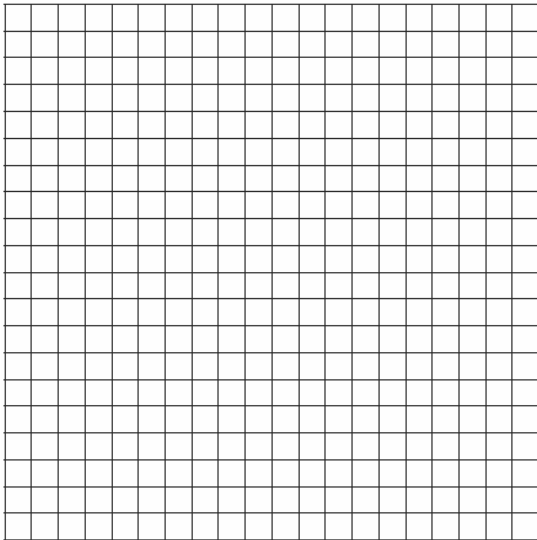

234. The path of a rocket fired during a fireworks display is given by the equation $s(t) = 64t - 16t^2$, where t is the time, in seconds, and s is the height, in feet. What is the maximum height, in feet, the rocket will reach? In how many seconds will the rocket hit the ground? [The use of the grid is optional.]

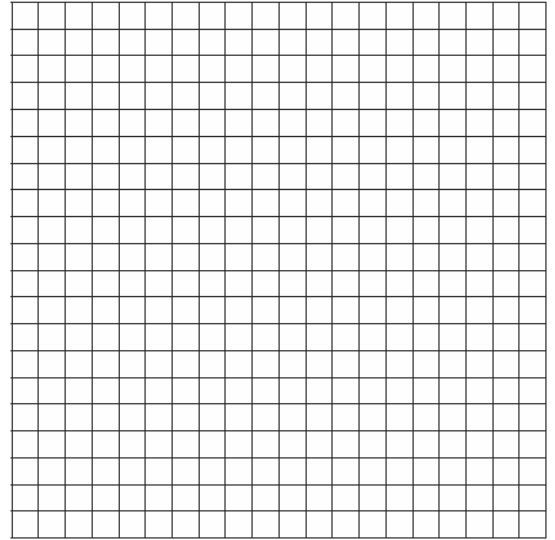

QUADRATICS WITH NONINTEGER SOLUTIONS

235. A ball is thrown straight up at an initial velocity of 54 feet per second. The height of the ball t seconds after it is thrown is given by the formula $h(t) = 54t - 12t^2$. How many seconds after the ball is thrown will it return to the ground?
[A] 4.5 [B] 6 [C] 9.2 [D] 4
236. If the sum of the roots of $x^2 + 3x - 5$ is added to the product of its roots, the result is
[A] -15 [B] -8 [C] -2 [D] 15

237. Barb pulled the plug in her bathtub and it started to drain. The amount of water in the bathtub as it drains is represented by the equation $L = -5t^2 - 8t + 120$, where L represents the number of liters of water in the bathtub and t represents the amount of time, in minutes, since the plug was pulled. How many liters of water were in the bathtub when Barb pulled the plug? Show your reasoning.
Determine, to the *nearest tenth of a minute*, the amount of time it takes for all the water in the bathtub to drain.
238. Matt's rectangular patio measures 9 feet by 12 feet. He wants to increase the patio's dimensions so its area will be twice the area it is now. He plans to increase both the length and the width by the same amount, x . Find x , to the *nearest hundredth of a foot*.
239. A homeowner wants to increase the size of a rectangular deck that now measures 15 feet by 20 feet, but building code laws state that a homeowner cannot have a deck larger than 900 square feet. If the length and the width are to be increased by the same amount, find, to the *nearest tenth*, the maximum number of feet that the length of the deck may be increased in size legally.
240. A rectangular patio measuring 6 meters by 8 meters is to be increased in size to an area measuring 150 square meters. If both the width and the length are to be increased by the same amount, what is the number of meters, to the *nearest tenth*, that the dimensions will be increased?
241. If $2 + 3i$ is one root of a quadratic equation with real coefficients, what is the sum of the roots of the equation?
242. Express, in simplest $a + bi$ form, the roots of the equation $x^2 + 5 = 4x$.
243. Solve for x in simplest $a + bi$ form:
 $x^2 + 8x + 25 = 0$
244. In physics class, Taras discovers that the behavior of electrical power, x , in a particular circuit can be represented by the function $f(x) = x^2 + 2x + 7$. If $f(x) = 0$, solve the equation and express your answer in simplest $a + bi$ form.
245. For which equation is the sum of the roots equal to the product of the roots?
[A] $x^2 + 3x - 6 = 0$ [B] $x^2 - 4x + 4 = 0$
[C] $x^2 + x + 1 = 0$ [D] $x^2 - 8x - 4 = 0$
246. Which equation has the complex number $4 - 3i$ as a root?
[A] $x^2 - 6x + 25 = 0$ [B] $x^2 - 8x + 25 = 0$
[C] $x^2 + 8x - 25 = 0$ [D] $x^2 + 6x - 25 = 0$
247. Which quadratic equation has the roots $3 + i$ and $3 - i$?
[A] $x^2 + 6x + 8 = 0$ [B] $x^2 - 6x - 8 = 0$
[C] $x^2 + 6x - 10 = 0$ [D] $x^2 - 6x + 10 = 0$
248. If $2 + i$ and $2 - i$ are the roots of the equation $x^2 - 4x + c = 0$, what is the value of c ?
[A] -4 [B] 4 [C] 5 [D] -5

USING THE DISCRIMINANT

249. The roots of a quadratic equation are real, rational, and equal when the discriminant is
[A] 0 [B] 2 [C] -2 [D] 4
250. Which number is the discriminant of a quadratic equation whose roots are real, unequal, and irrational?
[A] 7 [B] 4 [C] 0 [D] -5

251. Jacob is solving a quadratic equation. He executes a program on his graphing calculator and sees that the roots are real, rational, and unequal. This information indicates to Jacob that the discriminant is
- [A] zero [B] a perfect square
[C] not a perfect square [D] negative
252. The roots of the equation $x^2 - 3x - 2 = 0$ are
- [A] imaginary
[B] real, rational, and equal
[C] real, rational, and unequal
[D] real, irrational, and unequal
253. The roots of the equation $2x^2 - 8x - 4 = 0$ are
- [A] real, irrational, and unequal
[B] real, rational, and unequal
[C] real, rational, and equal
[D] imaginary
254. The roots of the equation $2x^2 - x = 4$ are
- [A] real, rational, and unequal
[B] real and irrational [C] imaginary
[D] real, rational, and equal
255. The roots of the equation $2x^2 - 5 = 0$ are
- [A] real, rational, and unequal
[B] imaginary [C] real and irrational
[D] real, rational, and equal
256. Which equation has imaginary roots?
- [A] $x^2 - 1 = 0$ [B] $x^2 - x - 1 = 0$
[C] $x^2 + x + 1 = 0$ [D] $x^2 - 2 = 0$
257. Which equation has imaginary roots?
- [A] $(2x + 1)(x - 3) = 7$ [B] $x(x + 6) = -10$
[C] $x(5 - x) = -3$ [D] $x(5 + x) = 8$
258. For which positive value of m will the equation $4x^2 + mx + 9 = 0$ have roots that are real, equal, and rational?
- [A] 12 [B] 9 [C] 3 [D] 4
259. The roots of the equation $ax^2 + 4x = -2$ are real, rational, and equal when a has a value of
- [A] 3 [B] 1 [C] 2 [D] 4
260. In the equation $ax^2 + 6x - 9 = 0$, imaginary roots will be generated if
- [A] $-1 < a < 1$ [B] $a < -1$
[C] $a > -1$, only [D] $a < 1$, only
261. The equation $2x^2 + 8x + n = 0$ has imaginary roots when n is equal to
- [A] 6 [B] 8 [C] 10 [D] 4
262. Find all values of k such that the equation $3x^2 - 2x + k = 0$ has imaginary roots.
263. Given the function $y = f(x)$, such that the entire graph of the function lies above the x -axis. Explain why the equation $f(x) = 0$ has no real solutions.
264. Which statement must be true if a parabola represented by the equation $y = ax^2 + bx + c$ does not intersect the x -axis?
- [A] $b^2 - 4ac > 0$, and $b^2 - 4ac$ is not a perfect square.
[B] $b^2 - 4ac = 0$ [C] $b^2 - 4ac < 0$
[D] $b^2 - 4ac > 0$, and $b^2 - 4ac$ is a perfect square.

265. If the roots of $ax^2 + bx + c = 0$ are real, rational, and equal, what is true about the graph of the function $y = ax^2 + bx + c$?
- [A] It lies entirely below the x -axis.
[B] It is tangent to the x -axis.
[C] It intersects the x -axis in two distinct points.
[D] It lies entirely above the x -axis.
266. Which is a true statement about the graph of the equation $y = x^2 - 7x - 60$?
- [A] It intersects the x -axis in two distinct points that have irrational coordinates.
[B] It does not intersect the x -axis.
[C] It is tangent to the x -axis.
[D] It intersects the x -axis in two distinct points that have rational coordinates.

267. Which graph represents a quadratic function with a negative discriminant?

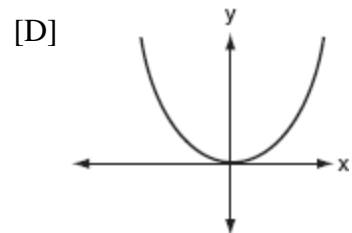
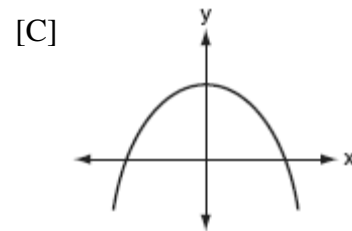
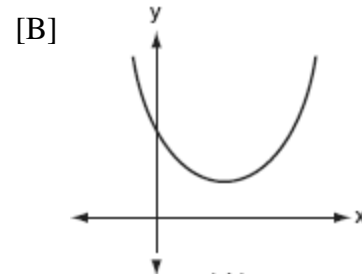
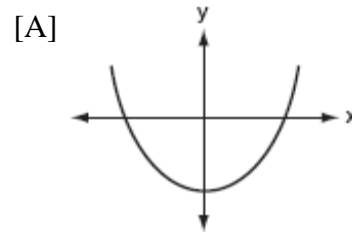

POWERS

ZERO AND NEGATIVE POWERS

268. Solve for x : $x^{-3} = \frac{27}{64}$

OPERATIONS WITH POWERS

269. The product of $(5ab)$ and $(-2a^2b)^3$ is
- [A] $-40a^6b^4$ [B] $-30a^7b^4$
[C] $-30a^6b^4$ [D] $-40a^7b^4$

270. The expression $\frac{(b^{2n+1})^3}{b^n \cdot b^{4n+3}}$ is equivalent to

- [A] b^{-3n} [B] $\frac{b^n}{2}$ [C] b^{-3n+1} [D] b^n

EXPONENTIAL FUNCTIONS

271. Which equation models the data in the accompanying table?

Time in hours, x	0	1	2	3	4	5	6
Population, y	5	10	20	40	80	160	320

- [A] $y = 2x$ [B] $y = 2^x$
 [C] $y = 5(2^x)$ [D] $y = 2x + 5$
272. What is the domain of $f(x) = 2^x$?
- [A] $x \leq 0$ [B] all real numbers
 [C] $x \geq 0$ [D] all integers

273. A population of wolves in a county is represented by the equation $P(t) = 80(0.98)^t$, where t is the number of years since 1998. Predict the number of wolves in the population in the year 2008.

274. The height, $f(x)$, of a bouncing ball after x bounces is represented by $f(x) = 80(0.5)^x$. How many times higher is the first bounce than the fourth bounce?

[A] 8 [B] 4 [C] 16 [D] 2

275. The accompanying graph represents the value of a bond over time.

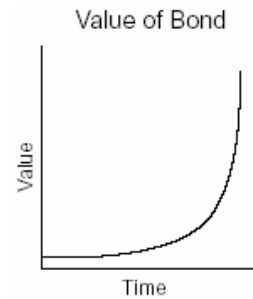

Which type of function does this graph best model?

- [A] quadratic [B] trigonometric
 [C] exponential [D] logarithmic

276. Which type of function could be used to model the data shown in the accompanying graph?

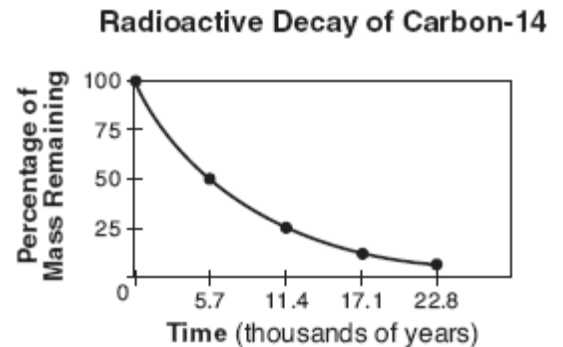

- [A] exponential [B] linear
 [C] trigonometric [D] quadratic

288. If $\log a = 2$ and $\log b = 3$, what is the numerical value of $\log \frac{\sqrt{a}}{b^3}$?
- [A] -25 [B] 25 [C] -8 [D] 8
289. If $\log x = a$, $\log y = b$, and $\log z = c$, then $\log \frac{x^2y}{\sqrt{z}}$ is equivalent to
- [A] $42a + b + \frac{1}{2}c$ [B] $2a + b - \frac{1}{2}c$
 [C] $2ab - \frac{1}{2}c$ [D] $a^2 + b - \frac{1}{2}c$
290. The expression $\log 10^{x+2} - \log 10^x$ is equivalent to
- [A] 100 [B] $\frac{1}{100}$ [C] -2 [D] 2
291. If $\log a = x$ and $\log b = y$, what is $\log a\sqrt{b}$?
- [A] $\frac{x+y}{2}$ [B] $2x+2y$
 [C] $x+2y$ [D] $x+\frac{y}{2}$
292. The speed of sound, v , at temperature T , in degrees Kelvin, is represented by the equation $v = 1087\sqrt{\frac{T}{273}}$. Which expression is equivalent to $\log v$?
- [A] $\log 1087 + \frac{1}{2}\log T - \frac{1}{2}\log 273$
 [B] $1087(\frac{1}{2}\log T - \frac{1}{2}\log 273)$
 [C] $\log 1087 + 2\log(T + 273)$
 [D] $1087 + \frac{1}{2}\log T - \log 273$
293. The equation used to determine the time it takes a swinging pendulum to return to its starting point is $T = 2\pi\sqrt{\frac{\ell}{g}}$, where T represents time, in seconds, ℓ represents the length of the pendulum, in feet, and g equals 32 ft/sec^2 . How is this equation expressed in logarithmic form?
- [A] $\log T = \log 2 + \log \pi + \frac{1}{2}\log \ell - \log 16$
 [B] $\log T = 2 + \log \pi + \frac{1}{2}\log \ell - 16$
 [C] $\log T = \log 2 + \log \pi + \frac{1}{2}\log \ell - \frac{1}{2}\log 32$
 [D] $\log T = \log 2 + \log \pi + \log \sqrt{\ell - 32}$
294. A black hole is a region in space where objects seem to disappear. A formula used in the study of black holes is the Schwarzschild formula, $R = \frac{2GM}{c^2}$. Based on the laws of logarithms, $\log R$ can be represented by
- [A] $\log 2 + \log G + \log M - 2\log c$
 [B] $2\log G + \log M - \log 2c$
 [C] $\log 2G + \log M - \log 2c$
 [D] $2\log GM - 2\log c$

GRAPHING LOGARITHMIC FUNCTIONS

295. The cells of a particular organism increase logarithmically. If g represents cell growth and h represents time, in hours, which graph best represents the growth pattern of the cells of this organism?

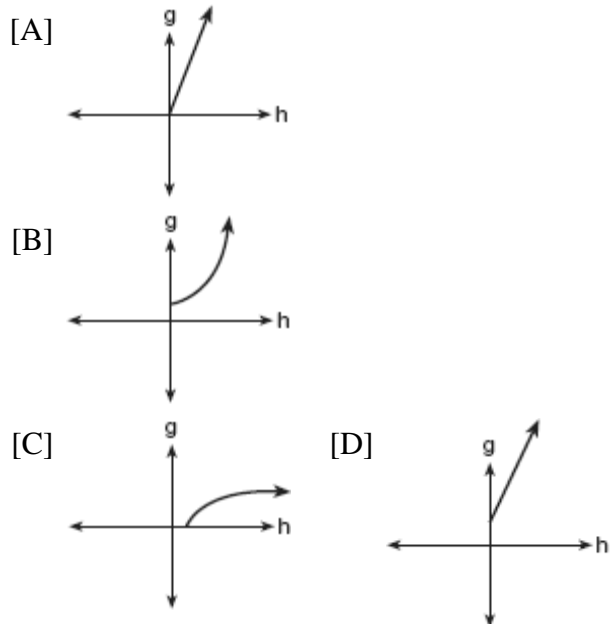

296. A hotel finds that its total annual revenue and the number of rooms occupied daily by guests can best be modeled by the function $R = 3\log(n^2 + 10n)$, $n > 0$, where R is the total annual revenue, in millions of dollars, and n is the number of rooms occupied daily by guests. The hotel needs an annual revenue of \$12 million to be profitable. Graph the function on the accompanying grid over the interval $0 < n \leq 100$.

Calculate the minimum number of rooms that must be occupied daily to be profitable.

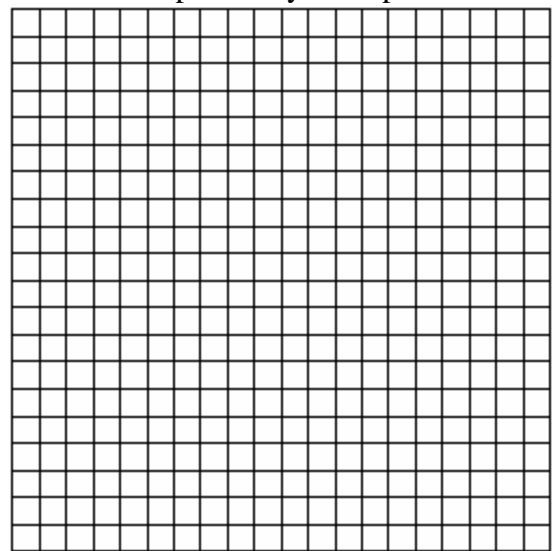

LOGARITHMIC EQUATIONS

297. If $\log_5 x = 2$, what is the value of \sqrt{x} ?

- [A] 25 [B] $2^{\frac{2}{5}}$ [C] 5 [D] $\sqrt{5}$

298. Solve for x : $\log_2(x+1) = 3$

299. If $\log k = c \log v + \log p$, k equals

- [A] $v^c p$ [B] $(vp)^c$
[C] $v^c + p$ [D] $cv + p$

300. In the equation $\log_x 4 + \log_x 9 = 2$, x is equal to

- [A] $\sqrt{13}$ [B] 6 [C] 18 [D] 6.5

301. Solve for x : $\log_b 36 - \log_b 2 = \log_b x$
302. Solve for x : $\log_4(x^2 + 3x) - \log_4(x + 5) = 1$
303. If $\log_2 a = \log_3 a$, what is the value of a ?
[A] 3 [B] 2 [C] 1 [D] 4
304. The relationship between the relative size of an earthquake, S , and the measure of the earthquake on the Richter scale, R , is given by the equation $\log S = R$. If an earthquake measured 3.2 on the Richter scale, what was its relative size to the *nearest hundredth*?
305. The magnitude (R) of an earthquake is related to its intensity (I) by $R = \log\left(\frac{I}{T}\right)$, where T is the threshold below which the earthquake is not noticed. If the intensity is doubled, its magnitude can be represented by
[A] $2(\log I - \log T)$ [B] $2 \log I - \log T$
[C] $\log 2 + \log I - \log T$ [D] $\log I - \log T$
306. The scientists in a laboratory company raise amoebas to sell to schools for use in biology classes. They know that one amoeba divides into two amoebas every hour and that the formula $t = \log_2 N$ can be used to determine how long in hours, t , it takes to produce a certain number of amoebas, N . Determine, to the *nearest tenth of an hour*, how long it takes to produce 10,000 amoebas if they start with one amoeba.
309. Solve algebraically for x : $8^{2x} = 4^6$
310. What is the value of x in the equation $81^{x+2} = 27^{5x+4}$?
[A] $-\frac{3}{2}$ [B] $-\frac{4}{11}$ [C] $\frac{4}{11}$ [D] $-\frac{2}{11}$
311. Solve algebraically for x : $27^{2x+1} = 9^{4x}$
312. Solve for m : $3^{m+1} - 5 = 22$
313. Determine the value of x and y if $2^y = 8^x$ and $3^y = 3^{x+4}$.
[A] $x = -2, y = -6$ [B] $x = 6, y = 2$
[C] $x = 2, y = 6$ [D] $x = y$
314. The growth of bacteria in a dish is modeled by the function $f(t) = 2^{\frac{t}{3}}$. For which value of t is $f(t) = 32$?
[A] 8 [B] 16 [C] 15 [D] 2
315. Growth of a certain strain of bacteria is modeled by the equation $G = A(2.7)^{0.584t}$, where:
 G = final number of bacteria
 A = initial number of bacteria
 t = time (in hours)
In approximately how many hours will 4 bacteria first increase to 2,500 bacteria? Round your answer to the *nearest hour*.

EXPONENTIAL EQUATIONS

307. The solution set of $2^{x^2+2x} = 2^{-1}$ is
[A] {1} [B] {} [C] {-1} [D] {-1, 1}
308. What is the value of b in the equation $4^{2b-3} = 8^{1-b}$?
[A] $\frac{10}{7}$ [B] $\frac{-3}{7}$ [C] $\frac{9}{7}$ [D] $\frac{7}{9}$

316. Since January 1980, the population of the city of Brownville has grown according to the mathematical model $y = 720,500(1.022)^x$, where x is the number of years since January 1980.

Explain what the numbers 720,500 and 1.022 represent in this model.

If this trend continues, use this model to predict the year during which the population of Brownville will reach 1,548,800. [The use of the grid is optional.]

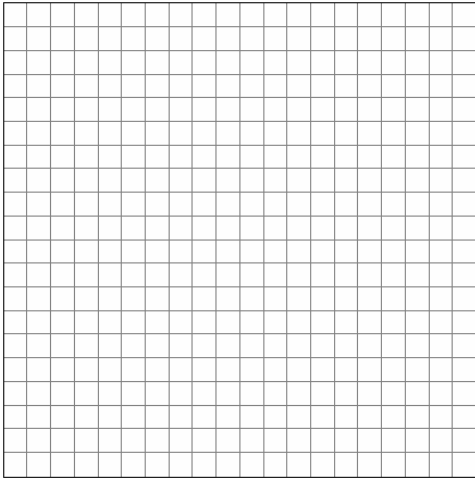

317. After an oven is turned on, its temperature, T , is represented by the equation $T = 400 - 350(3.2)^{-0.1m}$ where m represents the number of minutes after the oven is turned on and T represents the temperature of the oven, in degrees Fahrenheit. How many minutes does it take for the oven's temperature to reach 300°F ? Round your answer to the *nearest minute*. [The use of the grid is optional.]

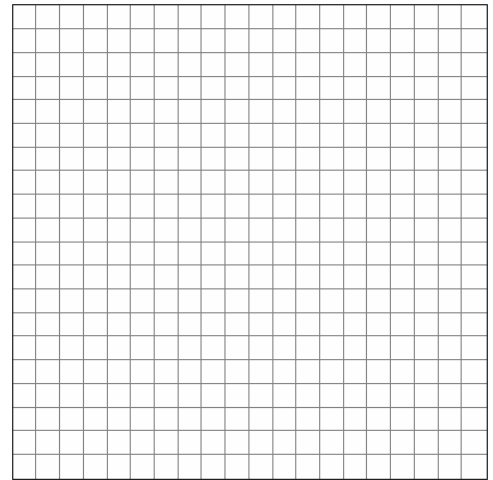

318. Drew's parents invested \$1,500 in an account such that the value of the investment doubles every seven years. The value of the investment, V , is determined by the equation $V = 1500(2)^{\frac{t}{7}}$, where t represents the number of years since the money was deposited. How many years, to the *nearest tenth of a year*, will it take the value of the investment to reach \$1,000,000?

319. An amount of P dollars is deposited in an account paying an annual interest rate r (as a decimal) compounded n times per year. After t years, the amount of money in the account, in dollars, is given by the equation

$$A = P\left(1 + \frac{r}{n}\right)^{nt}.$$

Rachel deposited \$1,000 at 2.8% annual interest, compounded monthly. In how many years, to the *nearest tenth of a year*, will she have \$2,500 in the account? [The use of the grid is optional.]

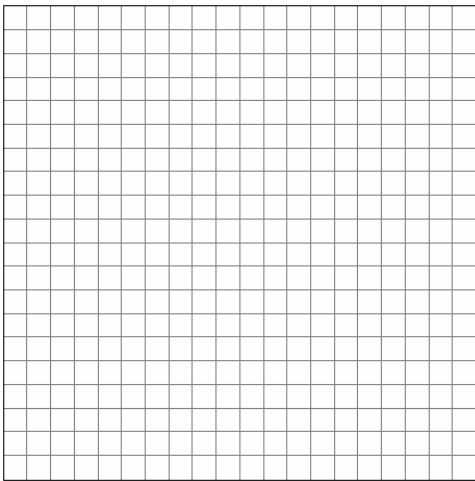

320. Sean invests \$10,000 at an annual rate of 5% compounded continuously, according to the formula $A = Pe^{rt}$, where A is the amount, P is the principal, $e = 2.718$, r is the rate of interest, and t is time, in years. Determine, to the *nearest dollar*, the amount of money he will have after 2 years. Determine how many years, to the *nearest year*, it will take for his initial investment to double.

321. The equation for radioactive decay is

$$p = (0.5)^{\frac{t}{H}},$$

where p is the part of a substance with half-life H remaining radioactive after a period of time, t .

A given substance has a half-life of 6,000 years. After t years, one-fifth of the original sample remains radioactive. Find t , to the *nearest thousand years*.

322. An archaeologist can determine the approximate age of certain ancient specimens by measuring the amount of carbon-14, a radioactive substance, contained in the specimen. The formula used to determine the age of a specimen is $A = A_0 2^{\frac{-t}{5760}}$, where A is the amount of carbon-14 that a specimen contains, A_0 is the original amount of carbon-14, t is time, in years, and 5760 is the half-life of carbon-14. A specimen that originally contained 120 milligrams of carbon-14 now contains 100 milligrams of this substance. What is the age of the specimen, to the *nearest hundred years*?

323. Depreciation (the decline in cash value) on a car can be determined by the formula $V = C(1 - r)^t$, where V is the value of the car after t years, C is the original cost, and r is the rate of depreciation. If a car's cost, when new, is \$15,000, the rate of depreciation is 30%, and the value of the car now is \$3,000, how old is the car to the *nearest tenth of a year*?

324. The amount A , in milligrams, of a 10-milligram dose of a drug remaining in the body after t hours is given by the formula $A = 10(0.8)^t$. Find, to the *nearest tenth of an hour*, how long it takes for half of the drug dose to be left in the body.

325. The current population of Little Pond, New York, is 20,000. The population is *decreasing*, as represented by the formula $P = A(1.3)^{-0.234t}$, where P = final population, t = time, in years, and A = initial population. What will the population be 3 years from now? Round your answer to the *nearest hundred people*.
To the *nearest tenth of a year*, how many years will it take for the population to reach half the present population? [The use of the grid is optional.]

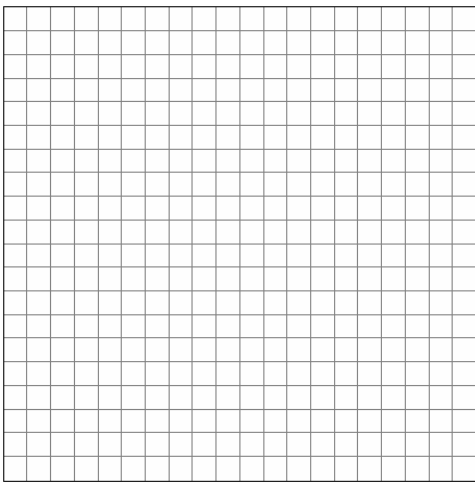

BINOMIAL EXPANSIONS

326. What is the *last* term in the expansion of $(x + 2y)^5$?
[A] $2y^5$ [B] $10y^5$ [C] $32y^5$ [D] y^5
327. What is the middle term in the expansion of $(x + y)^4$?
[A] $2x^2y^2$ [B] $4x^2y^2$
[C] $6x^2y^2$ [D] x^2y^2
328. What is the fourth term in the expansion of $(y - 1)^7$?
[A] $35y^4$ [B] $-35y^3$
[C] $-35y^4$ [D] $35y^3$

329. What is the fourth term in the expansion of $(2x - y)^5$?
330. What is the third term in the expansion of $\ln(\cos x + 3)$?
[A] $90\cos^2 x$ [B] $270\cos^2 x$
[C] $60\cos^3 x$ [D] $90\cos^3 x$

RADICALS

OPERATIONS WITH RADICALS

331. Classical mathematics uses the term "Golden Ratio" for the ratio $(1 + \sqrt{5}):2$. The Golden Ratio was used by many famous artists to determine the dimensions of their paintings. If the ratio of the length to the width of a painting is $(1 + \sqrt{5}):2$, find the length, in feet, of a painting that has a width of 14 feet. Express your answer in simplest radical form.

RATIONALIZING DENOMINATORS

332. Which expression is equivalent to $\frac{4}{3 + \sqrt{2}}$?
[A] $\frac{12 - 4\sqrt{2}}{7}$ [B] $\frac{12 + 4\sqrt{2}}{11}$
[C] $\frac{12 - 4\sqrt{2}}{11}$ [D] $\frac{12 + 4\sqrt{2}}{7}$
333. The expression $\frac{12}{3 + \sqrt{3}}$ is equivalent to
[A] $6 - 2\sqrt{3}$ [B] $4 - 2\sqrt{3}$
[C] $2 + \sqrt{3}$ [D] $12 - \sqrt{3}$
334. The expression $\frac{2}{1 - \sqrt{3}}$ is equivalent to
[A] $1 + \sqrt{3}$ [B] $1 - \sqrt{3}$
[C] $-1 - \sqrt{3}$ [D] $-1 + \sqrt{3}$

335. The expression $\frac{7}{2-\sqrt{3}}$ is equivalent to

[A] $14-7\sqrt{3}$ [B] $\frac{14+\sqrt{3}}{7}$

[C] $14+7\sqrt{3}$ [D] $\frac{2+\sqrt{3}}{7}$

336. The expression $\frac{7}{3-\sqrt{2}}$ is equivalent to

[A] $\frac{3+\sqrt{2}}{7}$ [B] $3+\sqrt{2}$

[C] $\frac{21+\sqrt{2}}{7}$ [D] $3-\sqrt{2}$

337. The expression $\frac{1}{5-\sqrt{13}}$ is equivalent to

[A] $\frac{5+\sqrt{13}}{-8}$ [B] $\frac{5+\sqrt{13}}{12}$

[C] $\frac{5+\sqrt{13}}{-12}$ [D] $\frac{5+\sqrt{13}}{8}$

338. The expression $\frac{4}{5-\sqrt{13}}$ is equivalent to

[A] $\frac{2(5-\sqrt{13})}{19}$ [B] $\frac{2(5+\sqrt{13})}{19}$

[C] $\frac{5+\sqrt{13}}{3}$ [D] $\frac{5-\sqrt{13}}{3}$

339. The expression $\frac{11}{\sqrt{3}-5}$ is equivalent to

[A] $\frac{-\sqrt{3}+5}{2}$ [B] $\frac{\sqrt{3}+5}{2}$

[C] $\frac{\sqrt{3}-5}{2}$ [D] $\frac{-\sqrt{3}-5}{2}$

340. The expression $\frac{5}{\sqrt{5}-1}$ is equivalent to

[A] $\frac{5}{4}$ [B] $\frac{5\sqrt{5}-5}{4}$

[C] $\frac{5\sqrt{5}-5}{6}$ [D] $\frac{5\sqrt{5}+5}{4}$

341. The fraction $\frac{3}{\sqrt{6}-1}$ is equivalent to

[A] $\frac{3\sqrt{6}+3}{5}$ [B] $\frac{3\sqrt{6}-3}{5}$

[C] $3\sqrt{6}-3$ [D] $3\sqrt{6}+3$

342. Which expression is equal to $\frac{2+\sqrt{3}}{2-\sqrt{3}}$?

[A] $\frac{1-4\sqrt{3}}{7}$ [B] $\frac{7+4\sqrt{3}}{7}$

[C] $7+4\sqrt{3}$ [D] $1-4\sqrt{3}$

343. Which expression represents the sum of $\frac{1}{\sqrt{3}} + \frac{1}{\sqrt{2}}$?

[A] $\frac{\sqrt{3}+\sqrt{2}}{3}$ [B] $\frac{\sqrt{3}+\sqrt{2}}{2}$

[C] $\frac{2}{\sqrt{5}}$ [D] $\frac{2\sqrt{3}+3\sqrt{2}}{6}$

PROPERTIES OF RADICALS

344. What is the domain of $h(x) = \sqrt{x^2 - 4x - 5}$?

[A] $\{x|-1 \leq x \leq 5\}$ [B] $\{x|-5 \leq x \leq 1\}$

[C] $\{x|x \geq 1 \text{ or } x \leq -5\}$

[D] $\{x|x \geq 5 \text{ or } x \leq -1\}$

345. Which statement is true for all real number values of x ?

- [A] $\sqrt{x^2} = x$ [B] $|x - 1| > (x - 1)$
[C] $\sqrt{x^2} = |x|$ [D] $|x - 1| > 0$

346. The formula $S = 20\sqrt{t + 273}$ is used to determine the speed of sound, S , in meters per second, near Earth's surface, where t is the surface temperature, in degrees Celsius. Which graph best represents this function?

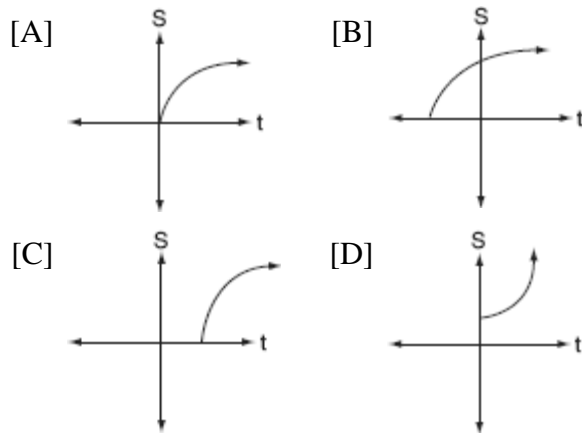

347. What is the axis of symmetry of the graph of the equation $x = y^2$?

- [A] line $y = -x$ [B] y -axis
[C] line $y = x$ [D] x -axis

SOLVING RADICALS

348. If $\sqrt{2x - 1} + 2 = 5$, then x is equal to
[A] 4 [B] 2 [C] 5 [D] 1

349. What is the solution of the equation $\sqrt{2x - 3} - 3 = 6$?
[A] 39 [B] 3 [C] 6 [D] 42

350. The solution set of the equation $\sqrt{x + 6} = x$ is
[A] $\{-2, 3\}$ [B] $\{3\}$ [C] $\{\}$ [D] $\{-2\}$

351. What is the solution set of the equation $\sqrt{9x + 10} = x$?
[A] $\{9\}$ [B] $\{-1\}$
[C] $\{10\}$ [D] $\{10, -1\}$

352. What is the solution set of the equation $x = 2\sqrt{2x - 3}$?
[A] $\{2\}$ [B] $\{\}$ [C] $\{2, 6\}$ [D] $\{6\}$

353. Solve for all values of q that satisfy the equation $\sqrt{3q + 7} = q + 3$.

354. Solve algebraically: $\sqrt{x + 5} + 1 = x$

355. Solve algebraically for x : $\sqrt{3x + 1} + 1 = x$

356. A wrecking ball suspended from a chain is a type of pendulum. The relationship between the rate of speed of the ball, R , the mass of the ball, m , the length of the chain, L , and the force, F , is $R = 2\pi\sqrt{\frac{mL}{F}}$. Determine the force, F , to the *nearest hundredth*, when $L = 12$, $m = 50$, and $R = 0.6$.

357. The lateral surface area of a right circular cone, s , is represented by the equation $s = \pi r\sqrt{r^2 + h^2}$, where r is the radius of the circular base and h is the height of the cone. If the lateral surface area of a large funnel is 236.64 square centimeters and its radius is 4.75 centimeters, find its height, to the *nearest hundredth of a centimeter*.

358. The equation $V = 20\sqrt{C + 273}$ relates speed of sound, V , in meters per second, to air temperature, C , in degrees Celsius. What is the temperature, in degrees Celsius, when the speed of sound is 320 meters per second? [The use of the accompanying grid is optional.]

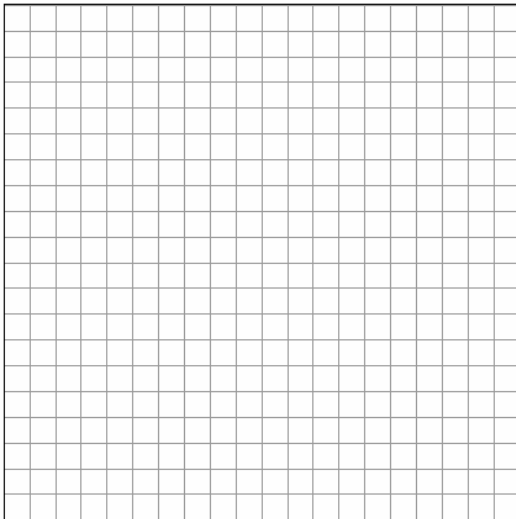

359. The number of people, y , involved in recycling in a community is modeled by the function $y = 90\sqrt{3x} + 400$, where x is the number of months the recycling plant has been open. Construct a table of values, sketch the function on the grid, and find the number of people involved in recycling exactly 3 months after the plant opened. After how many months will 940 people be involved in recycling?

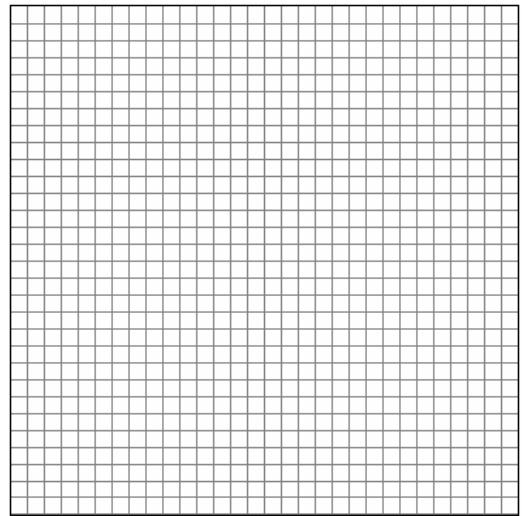

EXPONENTS AS RADICALS

360. The expression $4^{\frac{1}{2}} \cdot 2^3$ is equal to
[A] $4^{\frac{3}{2}}$ [B] 4 [C] 16 [D] $8^{\frac{3}{2}}$
361. The expression $\frac{3^{\frac{1}{3}}}{2^{-\frac{1}{3}}}$ is equivalent to
[A] $\sqrt{3}$ [B] $\frac{1}{\sqrt[3]{3}}$ [C] 3 [D] 1
362. The value of $(\frac{3^0}{2^{\frac{1}{2}}})^{-1}$ is
[A] $\frac{1}{9}$ [B] $-\frac{1}{9}$ [C] 9 [D] -9

363. If x is a positive integer, $4x^{\frac{1}{2}}$ is equivalent to

- [A] $\frac{2}{x}$ [B] $4\frac{1}{x}$ [C] $2x$ [D] $4\sqrt{x}$

364. The expression $b^{-\frac{3}{2}}$, $b > 0$, is equivalent to

- [A] $\frac{1}{(\sqrt[3]{b})^2}$ [B] $-(\sqrt{b})^3$
[C] $(\sqrt[3]{b})^2$ [D] $\frac{1}{(\sqrt{b})^3}$

365. The volume of a soap bubble is represented by the equation $V = 0.094\sqrt{A^3}$, where A represents the surface area of the bubble. Which expression is also equivalent to V ?

- [A] $0.094A^{\frac{3}{2}}$ [B] $0.094A^{\frac{2}{3}}$
[C] $0.094A^6$ [D] $(0.094A^3)^{\frac{1}{2}}$

366. The expression $\sqrt[4]{16a^6b^4}$ is equivalent to

- [A] $4a^{\frac{3}{2}}b$ [B] $2a^2b$
[C] $4a^2b$ [D] $2a^{\frac{3}{2}}b$

367. When simplified, the expression $(\sqrt[3]{m^4})(m^{-\frac{1}{2}})$ is equivalent to

- [A] $\sqrt[6]{m^5}$ [B] $\sqrt[4]{m^3}$
[C] $\sqrt[5]{m^{-4}}$ [D] $\sqrt[3]{m^{-2}}$

368. Find the value of $(x+2)^0 + (x+1)^{-\frac{2}{3}}$ when $x = 7$.

369. If $f(x) = x^{\frac{3}{2}}$, then $f(\frac{1}{4})$ is equal to

- [A] -2 [B] -4 [C] $-\frac{1}{8}$ [D] 8

370. If $(a^x)^{\frac{2}{3}} = \frac{1}{a^2}$, what is the value of x ?

- [A] -1 [B] 2 [C] -3 [D] 1

371. Meteorologists can determine how long a storm lasts by using the function

$t(d) = 0.07d^{\frac{3}{2}}$, where d is the diameter of the storm, in miles, and t is the time, in hours. If the storm lasts 4.75 hours, find its diameter, to the nearest tenth of a mile.

RATIONALS

MULTIPLICATION AND DIVISION OF RATIONALS

372. A rectangular prism has a length of $\frac{2x^2 + 2x - 24}{4x^2 + x}$, a width of $\frac{x^2 + x - 6}{x + 4}$, and a height of $\frac{8x^2 + 2x}{x^2 - 9}$. For all values of x for which it is defined, express, in terms of x , the volume of the prism in simplest form.

373. If the length of a rectangular garden is represented by $\frac{x^2 + 2x}{x^2 + 2x - 15}$ and its width is represented by $\frac{2x - 6}{2x + 4}$, which expression represents the area of the garden?

- [A] x [B] $x + 5$
[C] $\frac{x}{x + 5}$ [D] $\frac{x^2 + 2x}{2(x + 5)}$

374. If $f(x) = \frac{3x^2 - 27}{18x + 30}$ and $g(x) = \frac{x^2 - 7x + 12}{3x^2 - 7x - 20}$, find $f(x) \div g(x)$ for all values of x for which the expression is defined and express your answer in simplest form.

375. Express in simplest form:

$$\frac{4x+8}{x+1} \cdot \frac{2-x}{3x-15} \div \frac{x^2-4}{2x^2-8x-10}$$

376. Perform the indicated operations and simplify completely:

$$\frac{x^2-9}{x^2-5x} \cdot \frac{5x-x^2}{x^2-x-12} \div \frac{x-4}{x^2-8x+16}$$

ADDITION AND SUBTRACTION OF RATIONALS

377. Express in simplest form: $\frac{1}{x} + \frac{1}{x+3}$

378. What is the sum of $\frac{3}{x-3}$ and $\frac{x}{3-x}$?

[A] 1 [B] 0 [C] -1 [D] $\frac{x+3}{x-3}$

379. What is the sum of $(y-5) + \frac{3}{y+2}$?

[A] $y-5$ [B] $\frac{y^2-3y-7}{y+2}$

[C] $\frac{y-2}{y+2}$ [D] $\frac{y^2-7}{y+2}$

380. Express in simplest form:

$$\frac{2x}{x^2-4} \div \frac{4}{x^2-4x+4} + \frac{12}{x^2-4} \cdot \frac{2-x}{3}$$

SOLVING RATIONALS

381. Solve for all values of x : $\frac{2}{x+1} = x$

382. Solve for all values of x : $\frac{9}{x} + \frac{9}{x-2} = 12$

383. Solve for x and express your answer in simplest radical form:

$$\frac{4}{x} - \frac{3}{x+1} = 7$$

384. What is the solution set of the equation

$$\frac{x}{x-4} - \frac{1}{x+3} = \frac{28}{x^2-x-12}?$$

[A] {4,-6} [B] { } [C] {-6} [D] {4}

385. A rectangle is said to have a golden ratio

when $\frac{w}{h} = \frac{h}{w-h}$, where w represents width and h represents height. When $w = 3$, between which two consecutive integers will h lie?

386. Working by herself, Mary requires 16 minutes more than Antoine to solve a mathematics problem. Working together, Mary and Antoine can solve the problem in 6 minutes. If this situation is represented by the equation $\frac{6}{t} + \frac{6}{t+16} = 1$, where t represents the number of minutes Antoine works alone to solve the problem, how many minutes will it take Antoine to solve the problem if he works by himself?

387. Electrical circuits can be connected in series, one after another, or in parallel circuits that branch off a main line. If circuits are hooked up in parallel, the reciprocal of the total resistance in the series is found by adding the reciprocals of each resistance, as shown in the accompanying diagram.

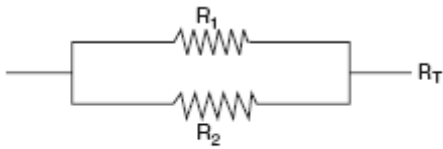

$$\frac{1}{R_1} + \frac{1}{R_2} = \frac{1}{R_T}$$

If $R_1 = x$, $R_2 = x + 3$, and the total resistance, R_T , is 2.25 ohms, find the positive value of R_1 to the nearest tenth of an ohm.

RATIONAL EXPRESSIONS

388. Which expression is in simplest form?
- [A] $\frac{9}{x^2 + 9}$ [B] $\frac{x}{x^2}$
 [C] $\frac{x^2 - 6x + 9}{x^2 - x - 6}$ [D] $\frac{x^2 - 4}{x + 2}$
389. Written in simplest form, the expression $\frac{x^2 y^2 - 9}{3 - xy}$ is equivalent to
- [A] $-(3 + xy)$ [B] $\frac{1}{3 + xy}$
 [C] -1 [D] $3 + xy$
390. Written in simplest form, the expression $\frac{x^2 - 9x}{45x - 5x^2}$ is equivalent to
- [A] 5 [B] $-\frac{1}{5}$ [C] -5 [D] $\frac{1}{5}$

391. The expression $\frac{3y^2 - 12y}{4y^2 - y^3}$ is equivalent to
- [A] $-\frac{9}{4}$ [B] $-\frac{3}{y}$ [C] $\frac{3}{4} - \frac{12}{y^2}$ [D] $\frac{3}{y}$
392. Express the following rational expression in simplest form:
- $$\frac{9 - x^2}{10x^2 - 28x - 6}$$
393. For all values of x for which the expression is defined, $\frac{2x + x^2}{x^2 + 5x + 6}$ is equivalent to
- [A] $\frac{1}{x + 2}$ [B] $\frac{x}{x + 2}$
 [C] $\frac{x}{x + 3}$ [D] $\frac{1}{x + 3}$

RATIONAL FUNCTIONS

394. Which function is symmetrical with respect to the origin?
- [A] $y = \sqrt{x + 5}$ [B] $y = |5 - x|$
 [C] $y = -\frac{5}{x}$ [D] $y = 5^x$
395. Which equation represents a hyperbola?
- [A] $y = 16 - x^2$ [B] $y = \frac{16}{x}$
 [C] $y^2 = 16 - x^2$ [D] $y = 16x^2$

396. The accompanying graph shows the relationship between a person's weight and the distance that the person must sit from the center of a seesaw to make it balanced.

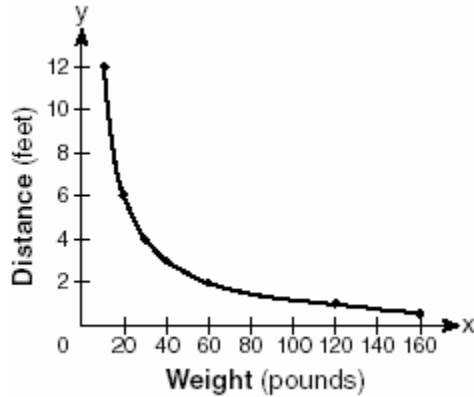

Which equation best represents this graph?

- [A] $y = 12x^2$ [B] $y = -120x$
 [C] $y = 2 \log x$ [D] $y = \frac{120}{x}$
397. Which graph shows that soil permeability varies inversely to runoff?

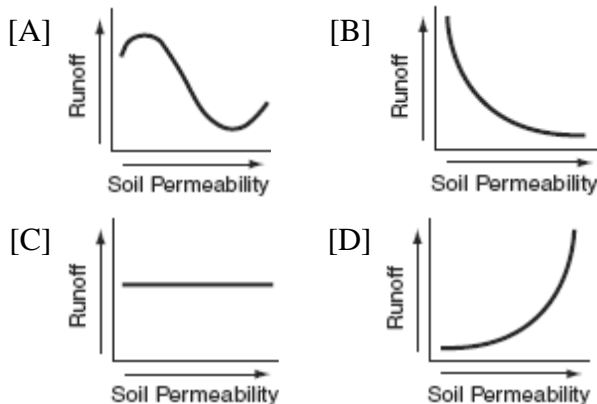

398. Which graph represents an inverse variation between stream velocity and the distance from the center of the stream?

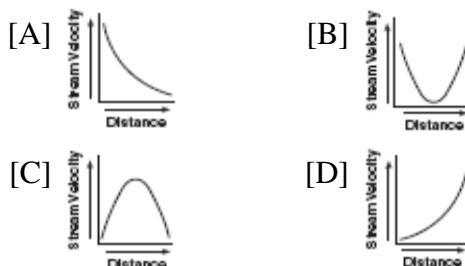

399. What is the domain of the function

$$f(x) = \frac{2x^2}{x^2 - 9}$$

- [A] all real numbers except 0
 [B] all real numbers
 [C] all real numbers except 3 and -3
 [D] all real numbers except 3

400. What is the domain of the function

$$f(x) = \frac{3x^2}{x^2 - 49}$$

- [A] $\{x \mid x \in \text{real numbers}, x \neq 7\}$
 [B] $\{x \mid x \in \text{real numbers}, x \neq 0\}$
 [C] $\{x \mid x \in \text{real numbers}, x \neq \pm 7\}$
 [D] $\{x \mid x \in \text{real numbers}\}$

401. If $f(x) = \frac{1}{\sqrt{2x-4}}$, the domain of $f(x)$ is

- [A] $x < 2$ [B] $x \geq 2$
 [C] $x = 2$ [D] $x > 2$

COMPLEX FRACTIONS

402. The expression $\frac{\frac{a-b}{b} - \frac{a}{1+\frac{1}{b}}}{\frac{1}{a} + \frac{1}{b}}$ is equivalent to

- [A] $\frac{a-b}{ab}$ [B] $a+b$
 [C] ab [D] $a-b$

403. The fraction $\frac{\frac{x}{y} + x}{\frac{1}{y} + 1}$ is equivalent to

- [A] x [B] $\frac{x^2y}{1+y}$ [C] $2x$ [D] $\frac{2xy}{1+y}$

404. Which expression is equivalent to the

complex fraction $\frac{\frac{1}{-a} - a}{\frac{1}{-a} + 1}$?

- [A] +1 [B] -1
[C] 1-a [D] -(1-a)

405. In simplest form, $\frac{\frac{1}{x^2} - \frac{1}{y^2}}{\frac{1}{y} + \frac{1}{x}}$ is equal to

- [A] $\frac{y-x}{xy}$ [B] $x-y$
[C] $\frac{x-y}{xy}$ [D] $y-x$

406. The expression $\frac{\frac{1}{3} + \frac{1}{3x}}{\frac{1}{x} + \frac{1}{3}}$ is equivalent to

- [A] 2 [B] $\frac{x+1}{x+3}$ [C] $\frac{3x+3}{x+3}$ [D] $\frac{1}{3}$

407. The expression $\frac{\frac{1}{3} - \frac{1}{x}}{\frac{3}{x} - 1}$ is equivalent to

- [A] -3 [B] $-\frac{1}{3}$ [C] 3 [D] $\frac{1}{3}$

408. Express in simplest form: $\frac{\frac{x}{4} - \frac{4}{x}}{1 - \frac{4}{x}}$

409. The expression $\frac{\frac{1}{x} + \frac{1}{y}}{\frac{1}{x^2} - \frac{1}{y^2}}$ is equivalent to

- [A] $\frac{y-x}{xy}$ [B] $y-x$
[C] $\frac{xy}{y-x}$ [D] $\frac{xy}{x-y}$

410. Which expression is equivalent to the

complex fraction $\frac{\frac{x}{x+2}}{1 - \frac{x}{x+2}}$?

- [A] $\frac{2x}{x+2}$ [B] $\frac{2x}{x^2+4}$ [C] $\frac{2}{x}$ [D] $\frac{x}{2}$

411. Express in simplest form: $\frac{\frac{1}{r} - \frac{1}{s}}{\frac{r}{r^2} - 1}$

412. When simplified, the complex fraction

$\frac{1 + \frac{1}{x}}{\frac{1}{-x} - x}$, $x \neq 0$, is equivalent to

- [A] 1 [B] -1 [C] $\frac{1}{x-1}$ [D] $\frac{1}{1-x}$

413. Simplify completely: $\frac{\frac{1-m}{m}}{m - \frac{1}{m}}$

414. Simplify for all values of a for which the

expression is defined: $\frac{1 - \frac{2}{a}}{\frac{4}{a^2} - 1}$

415. In a science experiment, when resistor A and resistor B are connected in a parallel circuit, the total resistance is $\frac{1}{\frac{1}{A} + \frac{1}{B}}$. This complex fraction is equivalent to
- [A] $A + B$ [B] $\frac{AB}{A + B}$ [C] 1 [D] AB

INVERSE VARIATION

416. Explain how a person can determine if a set of data represents inverse variation and give an example using a table of values.
417. For a rectangular garden with a fixed area, the length of the garden varies inversely with the width. Which equation represents this situation for an area of 36 square units?
- [A] $y = \frac{36}{x}$ [B] $x - y = 36$
[C] $x + y = 36$ [D] $y = 36x$
418. If R varies inversely as S , when S is doubled, R is multiplied by
- [A] $\frac{1}{4}$ [B] $\frac{1}{2}$ [C] 4 [D] 2
419. In a given rectangle, the length varies inversely as the width. If the length is doubled, the width will
- [A] increase by 2 [B] be multiplied by 2
[C] be divided by 2 [D] remain the same

420. The speed of a laundry truck varies inversely with the time it takes to reach its destination. If the truck takes 3 hours to reach its destination traveling at a constant speed of 50 miles per hour, how long will it take to reach the same location when it travels at a constant speed of 60 miles per hour?
- [A] 2 hours [B] $2\frac{2}{3}$ hours
[C] $2\frac{1}{3}$ hours [D] $2\frac{1}{2}$ hours
421. The time it takes to travel to a location varies inversely to the speed traveled. It takes 4 hours driving at an average speed of 55 miles per hour to reach a location. To the *nearest tenth of an hour*, how long will it take to reach the same location driving at an average speed of 50 miles per hour?
422. When air is pumped into an automobile tire, the pressure is inversely proportional to the volume. If the pressure is 35 pounds when the volume is 120 cubic inches, what is the pressure, in pounds, when the volume is 140 cubic inches?
423. Boyle's Law states that the pressure of compressed gas is inversely proportional to its volume. The pressure of a certain sample of a gas is 16 kilopascals when its volume is 1,800 liters. What is the pressure, in kilopascals, when its volume is 900 liters?
424. According to Boyle's Law, the pressure, p , of a compressed gas is inversely proportional to the volume, v . If a pressure of 20 pounds per square inch exists when the volume of the gas is 500 cubic inches, what is the pressure when the gas is compressed to 400 cubic inches?
- [A] 50 lb/in² [B] 25 lb/in²
[C] 16 lb/in² [D] 40 lb/in²

425. Camisha is paying a band \$330 to play at her graduation party. The amount each member earns, d , varies inversely as the number of members who play, n . The graph of the equation that represents the relationship between d and n is an example of

- [A] an ellipse [B] a hyperbola
[C] a line [D] a parabola

426. The price per person to rent a limousine for a prom varies inversely as the number of passengers. If five people rent the limousine, the cost is \$70 each. How many people are renting the limousine when the cost *per couple* is \$87.50?

427. To balance a seesaw, the distance, in feet, a person is from the fulcrum is inversely proportional to the person's weight, in pounds. Bill, who weighs 150 pounds, is sitting 4 feet away from the fulcrum. If Dan weighs 120 pounds, how far from the fulcrum should he sit to balance the seesaw?

- [A] 3.5 ft [B] 5 ft [C] 3 ft [D] 4.5 ft

428. A pulley that has a diameter of 8 inches is belted to a pulley that has a diameter of 12 inches. The 8-inch-diameter pulley is running at 1,548 revolutions per minute. If the speeds of the pulleys vary inversely to their diameters, how many revolutions per minute does the larger pulley make?

430. Expressed as a function of a positive acute angle, $\sin(-230^\circ)$ is equal to

- [A] $-\cos 50^\circ$ [B] $-\sin 50^\circ$
[C] $\sin 50^\circ$ [D] $\cos 50^\circ$

431. If θ is an angle in standard position and its terminal side passes through the point

$(\frac{1}{2}, \frac{\sqrt{3}}{2})$ on a unit circle, a possible value of θ is

- [A] 120° [B] 30° [C] 150° [D] 60°

432. In the accompanying diagram, point $P(0.6, -0.8)$ is on unit circle O . What is the value of θ , to the *nearest degree*?

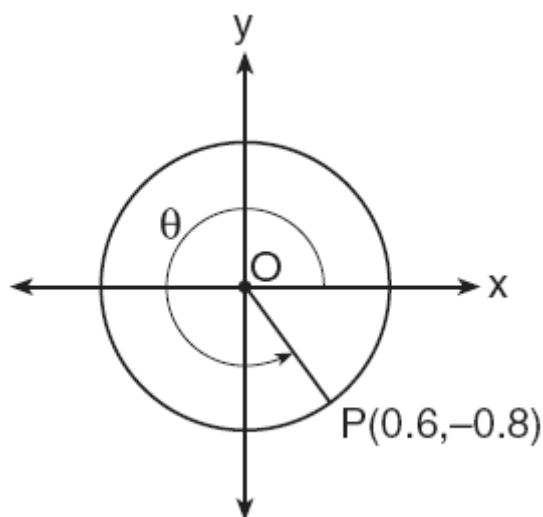

ANGLES

UNIT CIRCLE

429. Which angle is coterminal with an angle of 125° ?

- [A] 235° [B] -235°
[C] -125° [D] 425°

433. In the accompanying diagram of a unit circle, the ordered pair $(-\frac{\sqrt{3}}{2}, -\frac{1}{2})$ represents the point where the terminal side of θ intersects the unit circle.

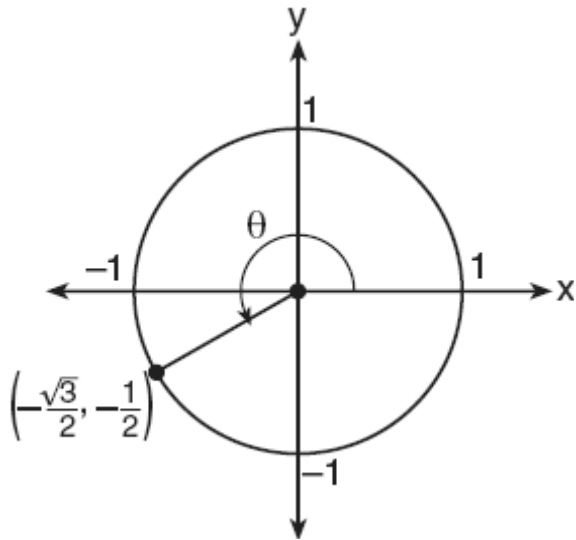

What is $m\angle\theta$?

- [A] 233 [B] 240 [C] 210 [D] 225
434. In the unit circle shown in the accompanying diagram, what are the coordinates of (x, y) ?

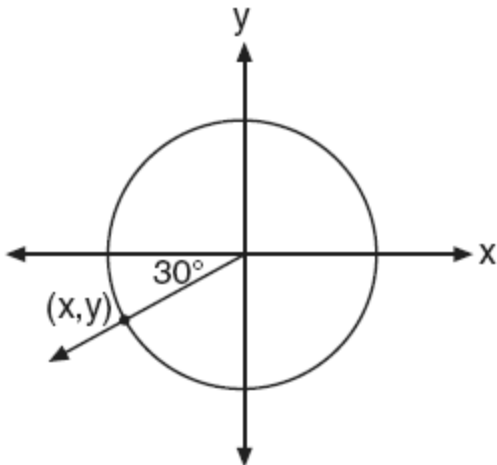

- [A] $(-30, -210)$ [B] $(-\frac{\sqrt{2}}{2}, -\frac{\sqrt{2}}{2})$
[C] $(-0.5, -\frac{\sqrt{3}}{2})$ [D] $(-\frac{\sqrt{3}}{2}, -0.5)$

435. If the sine of an angle is $\frac{3}{5}$ and the angle is *not* in Quadrant I, what is the value of the cosine of the angle?

436. In the accompanying diagram, \overline{PR} is tangent to circle O at R , $\overline{QS} \perp \overline{OR}$, and $\overline{PR} \perp \overline{OR}$.

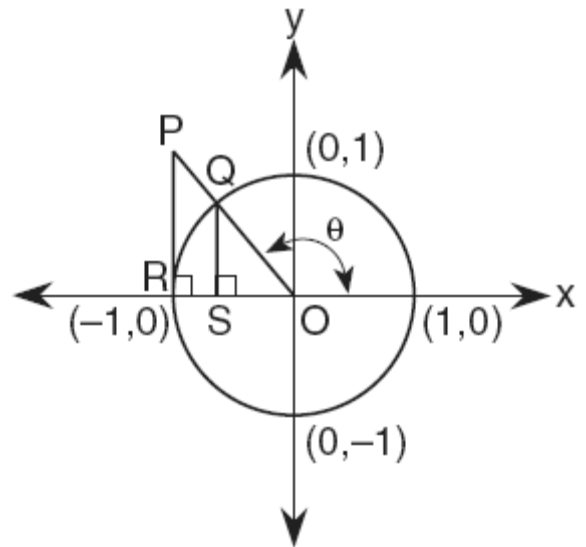

Which measure represents $\sin \theta$?

- [A] QS [B] PR [C] SO [D] RO

437. If x is a positive acute angle and $\cos x = \frac{\sqrt{3}}{4}$, what is the exact value of $\sin x$?

- [A] $\frac{3}{5}$ [B] $\frac{\sqrt{13}}{4}$ [C] $\frac{4}{5}$ [D] $\frac{\sqrt{3}}{5}$

438. The accompanying diagram shows unit circle O , with radius $OB = 1$.

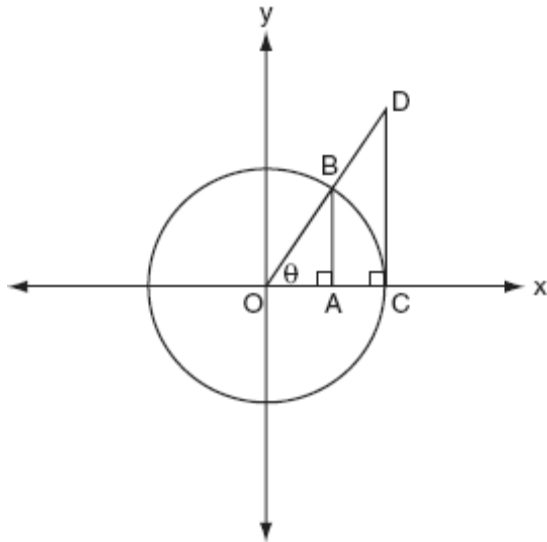

Which line segment has a length equivalent to $\cos \theta$?

- [A] \overline{OC} [B] \overline{AB} [C] \overline{OA} [D] \overline{CD}
439. Two straight roads intersect at an angle whose measure is 125° . Which expression is equivalent to the cosine of this angle?
- [A] $\cos 35^\circ$ [B] $-\cos 55^\circ$
[C] $\cos 55^\circ$ [D] $-\cos 35^\circ$
440. If θ is an angle in standard position and $P(-3,4)$ is a point on the terminal side of θ , what is the value of $\sin \theta$?
- [A] $-\frac{4}{5}$ [B] $\frac{4}{5}$ [C] $\frac{3}{5}$ [D] $-\frac{3}{5}$
441. If $\sin \theta > 0$ and $\sec \theta < 0$, in which quadrant does the terminal side of angle θ lie?
- [A] IV [B] III [C] II [D] I
442. If the tangent of an angle is negative and its secant is positive, in which quadrant does the angle terminate?
- [A] I [B] IV [C] II [D] III

443. If $\sin \theta$ is negative and $\cos \theta$ is negative, in which quadrant does the terminal side of θ lie?
- [A] I [B] III [C] IV [D] II
444. If $\tan \theta = 2.7$ and $\csc \theta < 0$, in which quadrant does θ lie?
- [A] IV [B] II [C] I [D] III
445. If θ is an obtuse angle and $\sin \theta = b$, then it can be concluded that
- [A] $\cos \theta > b$ [B] $\cos 2\theta > b$
[C] $\tan \theta > b$ [D] $\sin 2\theta < b$
446. Is $\frac{1}{2} \sin 2x$ the same expression as $\sin x$? Justify your answer.

RADIAN MEASURE

447. What is the number of degrees in an angle whose radian measure is $\frac{7\pi}{12}$?
448. What is 235° , expressed in radian measure?
- [A] $\frac{47\pi}{36}$ [B] $\frac{36\pi}{47}$
[C] $\frac{\pi}{235}$ [D] 235π
449. Through how many radians does the minute hand of a clock turn in 24 minutes?
- [A] 0.6π [B] 0.2π
[C] 0.4π [D] 0.8π
450. What is the radian measure of the angle formed by the hands of a clock at 2:00 p.m.?
- [A] $\frac{\pi}{4}$ [B] $\frac{\pi}{6}$ [C] $\frac{\pi}{2}$ [D] $\frac{\pi}{3}$

451. An art student wants to make a string collage by connecting six equally spaced points on the circumference of a circle to its center with string. What would be the radian measure of the angle between two adjacent pieces of string, in simplest form?
452. A wedge-shaped piece is cut from a circular pizza. The radius of the pizza is 6 inches. The rounded edge of the crust of the piece measures 4.2 inches. To the *nearest tenth*, the angle of the pointed end of the piece of pizza, in radians, is

[A] 1.4 [B] 0.7 [C] 7.0 [D] 25.2

453. A dog has a 20-foot leash attached to the corner where a garage and a fence meet, as shown in the accompanying diagram. When the dog pulls the leash tight and walks from the fence to the garage, the arc the leash makes is 55.8 feet.

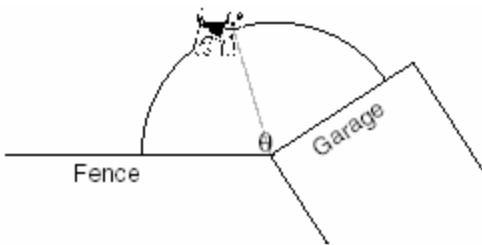

(Not drawn to scale)

What is the measure of angle θ between the garage and the fence, in radians?

[A] 0.36 [B] 3.14 [C] 2.79 [D] 160

454. Kristine is riding in car 4 of the Ferris wheel represented in the accompanying diagram. The Ferris wheel is rotating in the direction indicated by the arrows. The eight cars are equally spaced around the circular wheel. Express, in radians, the measure of the *smallest* angle through which she will travel to reach the bottom of the Ferris wheel.

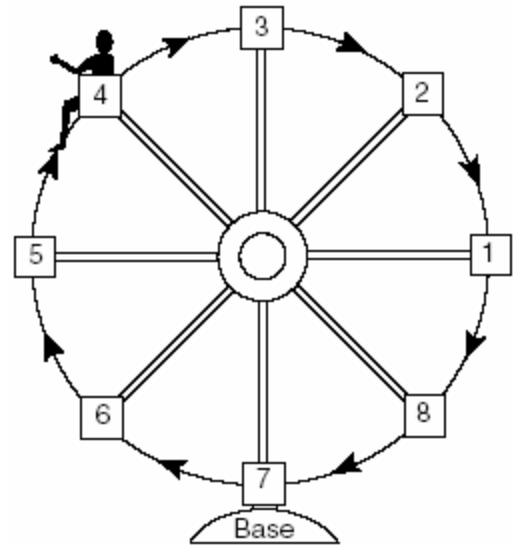

455. An arc of a circle that is 6 centimeters in length intercepts a central angle of 1.5 radians. Find the number of centimeters in the radius of the circle.
456. The pendulum of a clock swings through an angle of 2.5 radians as its tip travels through an arc of 50 centimeters. Find the length of the pendulum, in centimeters.

TRIGONOMETRIC IDENTITIES

457. The expression $\frac{1 - \cos^2 x}{\sin^2 x}$ is equivalent to
- [A] $\sin x$ [B] 1 [C] $\cos x$ [D] -1
458. The expression $(1 + \cos x)(1 - \cos x)$ is equivalent to
- [A] $\sec^2 x$ [B] 1
[C] $\csc^2 x$ [D] $\sin^2 x$

459. Express in simplest terms: $\frac{2 - 2 \sin^2 x}{\cos x}$

460. If $\csc \theta = -2$, what is the value of $\sin \theta$?

- [A] -2 [B] 2 [C] $\frac{1}{2}$ [D] $-\frac{1}{2}$

461. The expression $\sin A + \frac{\cos^2 A}{\sin A}$ is equivalent to

- [A] 1 [B] $\sin A$
[C] $\sec A$ [D] $\csc A$

462. If θ is a positive acute angle and $\sin \theta = a$, which expression represents $\cos \theta$ in terms of a ?

- [A] $\frac{1}{\sqrt{a}}$ [B] $\frac{1}{\sqrt{1-a^2}}$
[C] $\sqrt{1-a^2}$ [D] \sqrt{a}

463. The expression $\frac{\tan \theta}{\sec \theta}$ is equivalent to

- [A] $\cos \theta$ [B] $\sin \theta$
[C] $\frac{\sin \theta}{\cos^2 \theta}$ [D] $\frac{\cos^2 \theta}{\sin \theta}$

464. The expression $\frac{\sec \theta}{\csc \theta}$ is equivalent to

- [A] $\frac{\sin \theta}{\cos \theta}$ [B] $\frac{\cos \theta}{\sin \theta}$
[C] $\sin \theta$ [D] $\cos \theta$

465. A crate weighing w pounds sits on a ramp positioned at an angle of θ with the horizontal. The forces acting on this crate are modeled by the equation $Mw \cos \theta = w \sin \theta$, where M is the coefficient of friction. What is an expression for M in terms of θ ?

- [A] $M = \cot \theta$ [B] $M = \csc \theta$
[C] $M = \sec \theta$ [D] $M = \tan \theta$

DOUBLE ANGLE AND ANGLE SUM AND DIFFERENCE IDENTITIES

466. If A is a positive acute angle and $\sin A = \frac{\sqrt{5}}{3}$, what is $\cos 2A$?

- [A] $\frac{1}{3}$ [B] $-\frac{1}{9}$ [C] $-\frac{1}{3}$ [D] $\frac{1}{9}$

467. If x is an acute angle and $\sin x = \frac{12}{13}$, then $\cos 2x$ equals

- [A] $-\frac{119}{169}$ [B] $-\frac{25}{169}$
[C] $\frac{25}{169}$ [D] $\frac{119}{169}$

468. If $\sin \theta = \frac{\sqrt{5}}{3}$, then $\cos 2\theta$ equals

- [A] $-\frac{1}{3}$ [B] $\frac{1}{3}$ [C] $\frac{1}{9}$ [D] $-\frac{1}{9}$

469. If θ is an acute angle such that $\sin \theta = \frac{5}{13}$, what is the value of $\sin 2\theta$?

- [A] $\frac{12}{13}$ [B] $\frac{60}{169}$ [C] $\frac{10}{26}$ [D] $\frac{120}{169}$

470. If θ is a positive acute angle and $\sin 2\theta = \frac{\sqrt{3}}{2}$, then $(\cos \theta + \sin \theta)^2$ equals
- [A] 30° [B] 60° [C] 1 [D] $1 + \frac{\sqrt{3}}{2}$
471. If x is a positive acute angle and $\sin x = \frac{1}{2}$, what is $\sin 2x$?
- [A] $-\frac{1}{2}$ [B] $\frac{1}{2}$ [C] $\frac{\sqrt{3}}{2}$ [D] $-\frac{\sqrt{3}}{2}$
472. The expression $\frac{\sin 2\theta}{\sin^2 \theta}$ is equivalent to
- [A] $2 \cot \theta$ [B] $2 \tan \theta$
[C] $2 \cos \theta$ [D] $\frac{2}{\sin \theta}$
473. The expression $\frac{2 \cos \theta}{\sin 2\theta}$ is equivalent to
- [A] $\cot \theta$ [B] $\sec \theta$
[C] $\csc \theta$ [D] $\sin \theta$
474. If $\sin x = \frac{4}{5}$, where $0^\circ < x < 90^\circ$, find the value of $\cos(x + 180^\circ)$.
475. If A and B are positive acute angles, $\sin A = \frac{5}{13}$, and $\cos B = \frac{4}{5}$, what is the value of $\sin(A + B)$?
- [A] $\frac{63}{65}$ [B] $\frac{33}{65}$ [C] $\frac{56}{65}$ [D] $-\frac{16}{65}$
476. If $\sin A = \frac{4}{5}$, $\tan B = \frac{5}{12}$, and angles A and B are in Quadrant I, what is the value of $\sin(A + B)$?
- [A] $\frac{63}{65}$ [B] $-\frac{33}{65}$ [C] $\frac{33}{65}$ [D] $-\frac{63}{65}$

477. If $\sin x = \frac{12}{13}$, $\cos y = \frac{3}{5}$, and x and y are acute angles, the value of $\cos(x - y)$ is
- [A] $-\frac{33}{65}$ [B] $\frac{21}{65}$ [C] $\frac{63}{65}$ [D] $-\frac{14}{65}$
478. The expression $\cos 40^\circ \cos 10^\circ + \sin 40^\circ \sin 10^\circ$ is equivalent to
- [A] $\sin 30^\circ$ [B] $\cos 50^\circ$
[C] $\cos 30^\circ$ [D] $\sin 50^\circ$

SOLVING TRIGONOMETRIC EQUATIONS

479. A solution set of the equation $5 \sin \theta + 3 = 3$ contains all multiples of
- [A] 45° [B] 90° [C] 180° [D] 135°
480. Solve the following equation algebraically for all values of θ in the interval $0^\circ \leq \theta \leq 180^\circ$.
- $$2 \sin \theta - 1 = 0$$
481. An architect is using a computer program to design the entrance of a railroad tunnel. The outline of the opening is modeled by the function $f(x) = 8 \sin x + 2$, in the interval $0 \leq x \leq \pi$, where x is expressed in radians. Solve algebraically for all values of x in the interval $0 \leq x \leq \pi$, where the height of the opening, $f(x)$, is 6. Express your answer in terms of π .
If the x -axis represents the base of the tunnel, what is the maximum height of the entrance of the tunnel?
482. What value of x in the interval $0^\circ \leq x \leq 180^\circ$ satisfies the equation $\sqrt{3} \tan x + 1 = 0$?
- [A] 150° [B] -30° [C] 30° [D] 60°
483. Solve algebraically for all values of θ in the interval $0^\circ \leq \theta \leq 360^\circ$ that satisfy the equation
- $$\frac{\sin^2 \theta}{1 + \cos \theta} = 1.$$

484. In the interval $0^\circ \leq A \leq 360^\circ$, solve for all values of A in the equation $\cos 2A = -3 \sin A - 1$.
485. Navigators aboard ships and airplanes use nautical miles to measure distance. The length of a nautical mile varies with latitude. The length of a nautical mile, L , in feet, on the latitude line θ is given by the formula $L = 6,077 - 31 \cos 2\theta$.
Find, to the *nearest degree*, the angle θ , $0 \leq \theta \leq 90^\circ$, at which the length of a nautical mile is approximately 6,076 feet.
486. Find, to the *nearest degree*, all values of θ in the interval $0^\circ < \theta < 360^\circ$ that satisfy the equation $3 \cos 2\theta + \sin \theta - 1 = 0$.
487. If $(\sec x - 2)(2 \sec x - 1) = 0$, then x terminates in
 [A] Quadrants I and II, only
 [B] Quadrants I and IV, only
 [C] Quadrant I, only
 [D] Quadrants I, II, III, and IV
488. Find, to the *nearest degree*, all values of θ in the interval $0^\circ \leq \theta \leq 180^\circ$ that satisfy the equation $8 \cos^2 \theta - 2 \cos \theta - 1 = 0$.
489. What is a positive value of x for which $9^{-\cos x} = \frac{1}{3}$?
 [A] 30° [B] 45° [C] 60° [D] 90°
490. If $\sin 6A = \cos 9A$, then $m\angle A$ is equal to
 [A] 36 [B] 6 [C] 54 [D] $1\frac{1}{2}$

491. The average annual snowfall in a certain region is modeled by the function $S(t) = 20 + 10 \cos\left(\frac{\pi}{5}t\right)$, where S represents the annual snowfall, in inches, and t represents the number of years since 1970. What is the minimum annual snowfall, in inches, for this region? In which years between 1970 and 2000 did the minimum amount of snow fall? [The use of the grid is optional.]

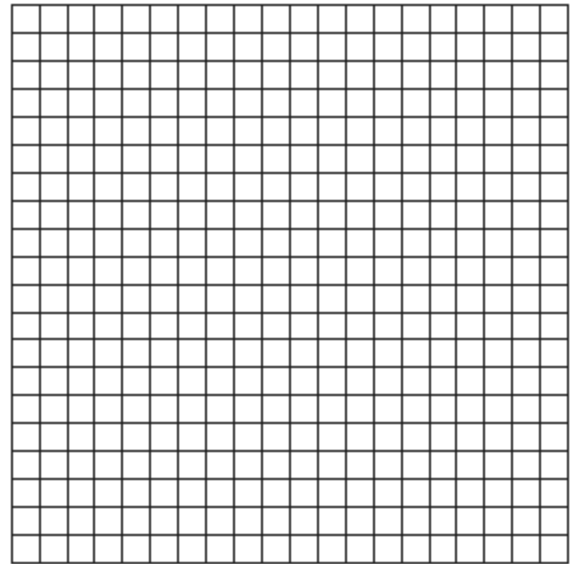

TRIGONOMETRIC GRAPHS

492. What is the period of the function $y = 5 \sin 3x$?
 [A] 5 [B] 3 [C] $\frac{2\pi}{5}$ [D] $\frac{2\pi}{3}$
493. What is the period of the graph of the equation $y = 2 \sin \frac{1}{3}x$?
 [A] $\frac{3\pi}{2}$ [B] 2π [C] $\frac{2}{3}\pi$ [D] 6π
494. A sound wave is modeled by the curve $y = 3 \sin 4x$. What is the period of this curve?
 [A] 4 [B] $\frac{\pi}{2}$ [C] π [D] 3

495. A certain radio wave travels in a path represented by the equation $y = 5 \sin 2x$. What is the period of this wave?

- [A] 2π [B] π [C] 2 [D] 5

496. A modulated laser heats a diamond. Its variable temperature, in degrees Celsius, is given by $f(t) = T \sin at$. What is the period of the curve?

- [A] $\frac{2\pi}{a}$ [B] $\frac{1}{a}$ [C] $|T|$ [D] $\frac{2a\pi}{a}$

497. The brightness of the star MIRA over time is given by the equation $y = 2 \sin \frac{\pi}{4}x + 6$, where x represents time and y represents brightness. What is the period of this function, in radian measure?

498. An object that weighs 2 pounds is suspended in a liquid. When the object is depressed 3 feet from its equilibrium point, it will oscillate according to the formula $x = 3 \cos(8t)$, where t is the number of seconds after the object is released. How many seconds are in the period of oscillation?

- [A] 3 [B] 2π [C] $\frac{\pi}{4}$ [D] π

499. What is the amplitude of the function shown in the accompanying graph?

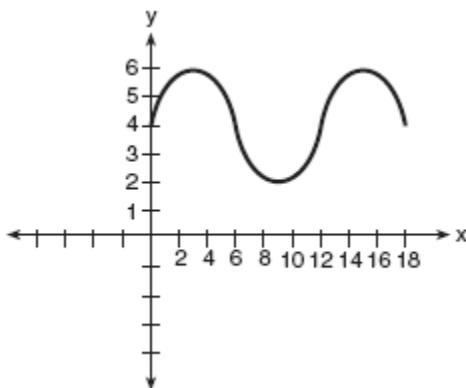

- [A] 2 [B] 1.5 [C] 12 [D] 6

500. What is the amplitude of the function $y = \frac{2}{3} \sin 4x$?

- [A] 4 [B] 3π [C] $\frac{\pi}{2}$ [D] $\frac{2}{3}$

501. A monitor displays the graph $y = 3 \sin 5x$. What will be the amplitude after a dilation of 2?

- [A] 6 [B] 5 [C] 7 [D] 10

502. The path traveled by a roller coaster is modeled by the equation $y = 27 \sin 13x + 30$. What is the maximum altitude of the roller coaster?

- [A] 27 [B] 57 [C] 13 [D] 30

503. The shaded portion of the accompanying map indicates areas of night, and the unshaded portion indicates areas of daylight at a particular moment in time.

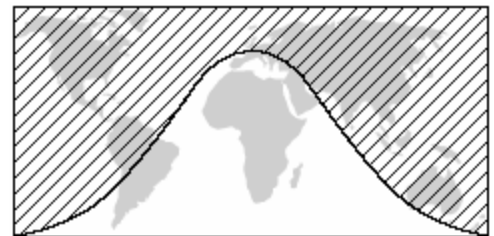

Which type of function best represents the curve that divides the area of night from the area of daylight?

- [A] cosine [B] logarithmic
[C] tangent [D] quadratic

504. Which transformation could be used to make the graph of the equation $y = \sin x$ coincide with the graph of the equation $y = \cos x$?

- [A] dilation [B] rotation
[C] translation [D] point reflection

505. The graphs below show the average annual precipitation received at different latitudes on Earth. Which graph is a translated cosine curve?

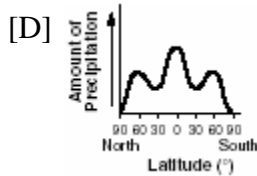
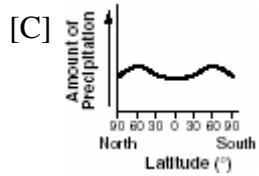
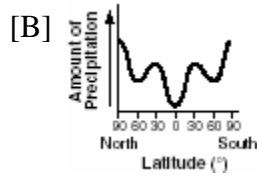
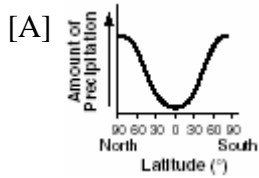

506. Which type of symmetry does the equation $y = \cos x$ have?

- [A] line symmetry with respect to the x -axis
- [B] point symmetry with respect to the origin
- [C] point symmetry with respect to $(\frac{\pi}{2}, 0)$
- [D] line symmetry with respect to $y = x$

507. Which equation is represented by the accompanying graph?

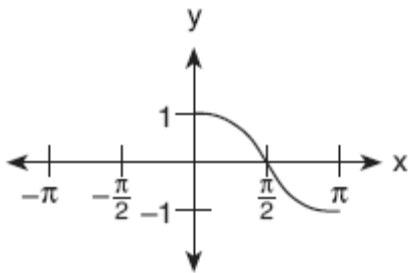

- [A] $y = \frac{1}{2} \cos x$
- [B] $y = \cos \frac{1}{2} x$
- [C] $y = \cos x$
- [D] $y = \cos 2x$

508. The accompanying graph represents a portion of a sound wave.

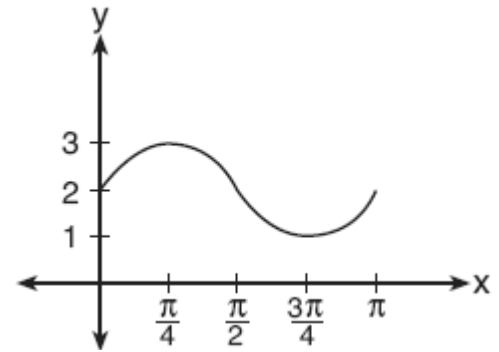

Which equation best represents this graph?

- [A] $y = 2 \sin \frac{1}{2} x$
- [B] $y = \sin \frac{1}{2} x + 2$
- [C] $y = \sin 2x$
- [D] $y = \sin 2x + 2$

509. In physics class, Eva noticed the pattern shown in the accompanying diagram on an oscilloscope.

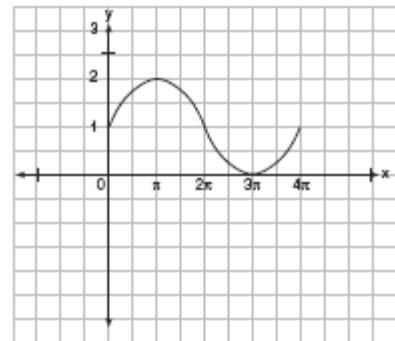

Which equation best represents the pattern shown on this oscilloscope?

- [A] $y = 2 \sin(-\frac{1}{2} x) + 1$
- [B] $y = \sin x + 1$
- [C] $y = \sin(\frac{1}{2} x) + 1$
- [D] $y = 2 \sin x + 1$

510. A radio transmitter sends a radio wave from the top of a 50-foot tower. The wave is represented by the accompanying graph.

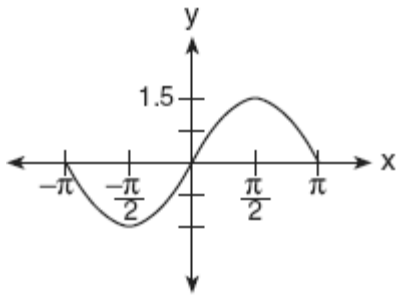

What is the equation of this radio wave?

- [A] $y = \sin x$ [B] $y = 2 \sin x$
 [C] $y = 1.5 \sin x$ [D] $y = \sin 1.5x$
511. The accompanying diagram shows a section of a sound wave as displayed on an oscilloscope.

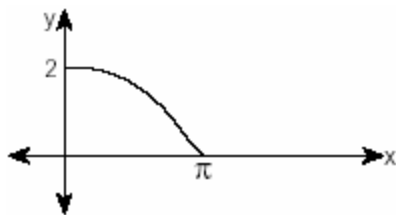

Which equation could represent this graph?

- [A] $y = \frac{1}{2} \cos 2x$ [B] $y = \frac{1}{2} \sin \frac{\pi}{2} x$
 [C] $y = 2 \cos \frac{x}{2}$ [D] $y = 2 \sin \frac{x}{2}$

512. A student attaches one end of a rope to a wall at a fixed point 3 feet above the ground, as shown in the accompanying diagram, and moves the other end of the rope up and down, producing a wave described by the equation $y = a \sin bx + c$. The range of the rope's height above the ground is between 1 and 5 feet. The period of the wave is 4π . Write the equation that represents this wave.

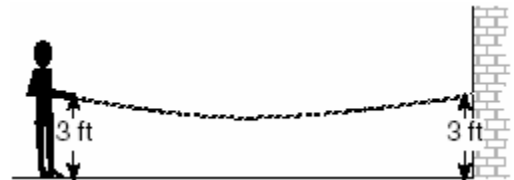

513. The times of average monthly sunrise, as shown in the accompanying diagram, over the course of a 12-month interval can be modeled by the equation $y = A \cos(Bx) + D$. Determine the values of A , B , and D , and explain how you arrived at your values.

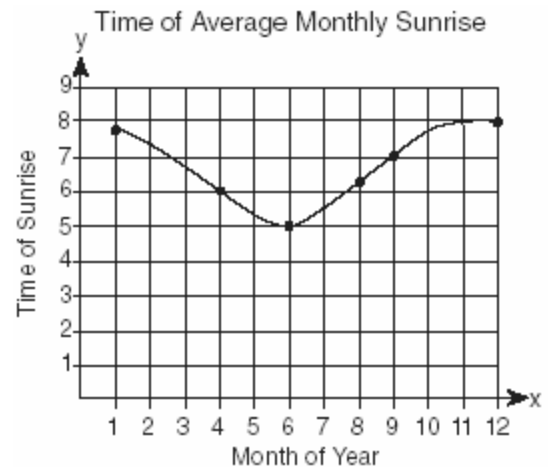

TRIANGLES

PYTHAGORAS

514. The accompanying diagram shows ramp \overline{RA} leading to level platform \overline{AM} , forming an angle of 45° with level ground. If platform \overline{AM} measures 2 feet and is 6 feet above the ground, explain why the exact length of ramp \overline{RA} is $6\sqrt{2}$ feet.

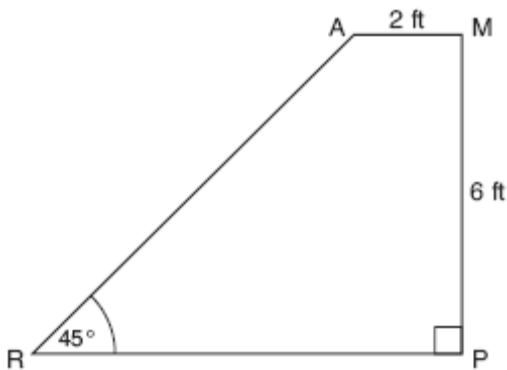

515. The accompanying diagram shows a semicircular arch over a street that has a radius of 14 feet. A banner is attached to the arch at points A and B, such that $AE = EB = 5$ feet. How many feet above the ground are these points of attachment for the banner?

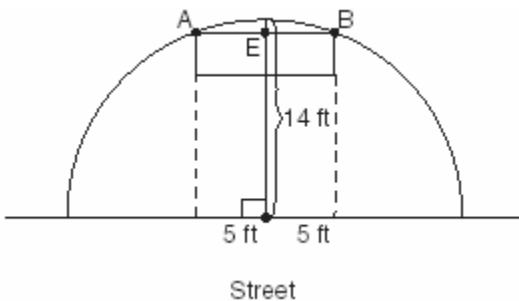

PERIMETER AND AREA OF TRIANGLES

516. If the perimeter of an equilateral triangle is 18, the length of the altitude of this triangle is
[A] 3 [B] $3\sqrt{3}$ [C] 6 [D] $6\sqrt{3}$

517. A garden in the shape of an equilateral triangle has sides whose lengths are 10 meters. What is the area of the garden?

- [A] $50\sqrt{3} m^2$ [B] $50 m^2$
[C] $25\sqrt{3} m^2$ [D] $25 m^2$

518. The accompanying diagram shows two cables of equal length supporting a pole. Both cables are 14 meters long, and they are anchored to points in the ground that are 14 meters apart.

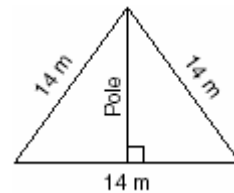

What is the exact height of the pole, in meters?

- [A] $7\sqrt{2}$ [B] 14 [C] $7\sqrt{3}$ [D] 7

TRIANGLE INEQUALITIES

519. A box contains one 2-inch rod, one 3-inch rod, one 4-inch rod, and one 5-inch rod. What is the maximum number of different triangles that can be made using these rods as sides?

- [A] 3 [B] 1 [C] 2 [D] 4

BASIC TRIGONOMETRIC RATIOS

520. At Mogul's Ski Resort, the beginner's slope is inclined at an angle of 12.3° , while the advanced slope is inclined at an angle of 26.4° . If Rudy skis 1,000 meters down the advanced slope while Valerie skis the same distance on the beginner's slope, how much longer was the horizontal distance that Valerie covered?

- [A] 81.3 m [B] 977.0 m
[C] 895.7 m [D] 231.6 m

USING TRIGONOMETRY TO FIND AREA

521. Jack is planting a triangular rose garden. The lengths of two sides of the plot are 8 feet and 12 feet, and the angle between them is 87° . Which expression could be used to find the area of this garden?

[A] $8 \cdot 12 \cdot \cos 87^\circ$ [B] $8 \cdot 12 \cdot \sin 87^\circ$

[C] $\frac{1}{2} \cdot 8 \cdot 12 \cdot \sin 87^\circ$

[D] $\frac{1}{2} \cdot 8 \cdot 12 \cdot \cos 87^\circ$

522. The accompanying diagram shows the floor plan for a kitchen. The owners plan to carpet all of the kitchen except the "work space," which is represented by scalene triangle ABC . Find the area of this work space to the *nearest tenth of a square foot*.

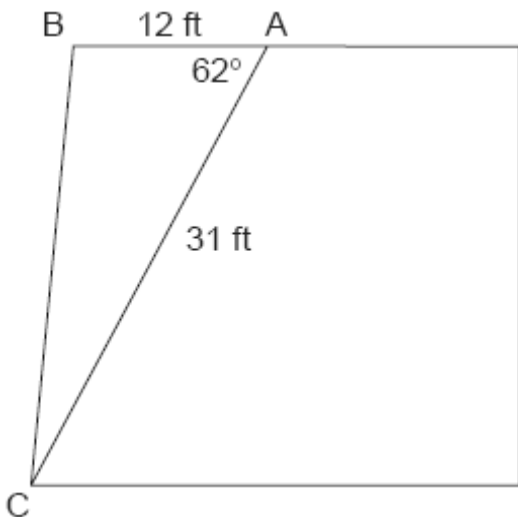

523. Two sides of a triangular-shaped pool measure 16 feet and 21 feet, and the included angle measures 58° . What is the area, to the *nearest tenth of a square foot*, of a nylon cover that would exactly cover the surface of the pool?
524. The triangular top of a table has two sides of 14 inches and 16 inches, and the angle between the sides is 30° . Find the area of the tabletop, in square inches.

525. A landscape architect is designing a triangular garden to fit in the corner of a lot. The corner of the lot forms an angle of 70° , and the sides of the garden including this angle are to be 11 feet and 13 feet, respectively. Find, to the *nearest integer*, the number of square feet in the area of the garden.

526. In $\triangle ABC$, $AC = 18$, $BC = 10$, and $\cos C = \frac{1}{2}$. Find the area of $\triangle ABC$ to the *nearest tenth of a square unit*.

527. The accompanying diagram shows a triangular plot of land that is part of Fran's garden. She needs to change the dimensions of this part of the garden, but she wants the area to stay the same. She increases the length of side AC to 22.5 feet. If angle A remains the same, by how many feet should side AB be *decreased* to make the area of the new triangular plot of land the same as the current one?

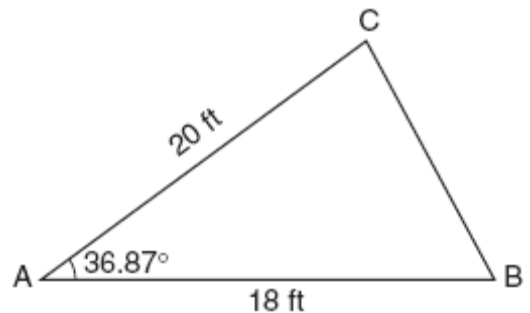

528. Gregory wants to build a garden in the shape of an isosceles triangle with one of the congruent sides equal to 12 yards. If the area of his garden will be 55 square yards, find, to the *nearest tenth of a degree*, the *three angles* of the triangle.

LAW OF COSINES

529. Two straight roads, Elm Street and Pine Street, intersect creating a 40° angle, as shown in the accompanying diagram. John's house (J) is on Elm Street and is 3.2 miles from the point of intersection. Mary's house (M) is on Pine Street and is 5.6 miles from the intersection. Find, to the *nearest tenth of a mile*, the direct distance between the two houses.

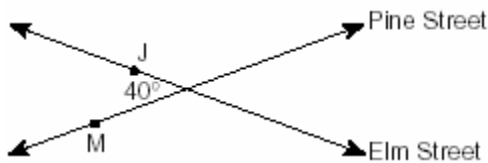

530. A ship at sea is 70 miles from one radio transmitter and 130 miles from another. The angle between the signals sent to the ship by the transmitters is 117.4° . Find the distance between the two transmitters, to the *nearest mile*.
531. The Vietnam Veterans Memorial in Washington, D.C., is made up of two walls, each 246.75 feet long, that meet at an angle of 125.2° . Find, to the *nearest foot*, the distance between the ends of the walls that do not meet.
532. To measure the distance through a mountain for a proposed tunnel, surveyors chose points A and B at each end of the proposed tunnel and a point C near the mountain. They determined that $AC = 3,800$ meters, $BC = 2,900$ meters, and $m\angle ACB = 110$. Draw a diagram to illustrate this situation and find the length of the tunnel, to the *nearest meter*.

533. A wooden frame is to be constructed in the form of an isosceles trapezoid, with diagonals acting as braces to strengthen the frame. The sides of the frame each measure 5.30 feet, and the longer base measures 12.70 feet. If the angles between the sides and the longer base each measure 68.4° , find the length of one brace to the *nearest tenth of a foot*.
534. Kieran is traveling from city A to city B . As the accompanying map indicates, Kieran could drive directly from A to B along County Route 21 at an average speed of 55 miles per hour or travel on the interstates, 45 miles along I-85 and 20 miles along I-64. The two interstates intersect at an angle of 150° at C and have a speed limit of 65 miles per hour. How much time will Kieran save by traveling along the interstates at an average speed of 65 miles per hour?

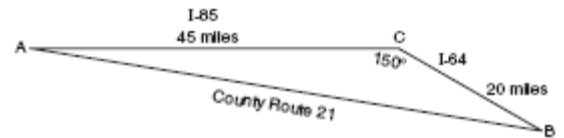

535. A surveyor is mapping a triangular plot of land. He measures two of the sides and the angle formed by these two sides and finds that the lengths are 400 yards and 200 yards and the included angle is 50° . What is the measure of the third side of the plot of land, to the *nearest yard*? What is the area of this plot of land, to the *nearest square yard*?
536. A triangular plot of land has sides that measure 5 meters, 7 meters, and 10 meters. What is the area of this plot of land, to the *nearest tenth of a square meter*?
537. A farmer has a triangular field with sides of 240 feet, 300 feet, and 360 feet. He wants to apply fertilizer to the field. If one 40-pound bag of fertilizer covers 6,000 square feet, how many bags must he buy to cover the field?

538. A farmer has determined that a crop of strawberries yields a yearly profit of \$1.50 per square yard. If strawberries are planted on a triangular piece of land whose sides are 50 yards, 75 yards, and 100 yards, how much profit, to the *nearest hundred dollars*, would the farmer expect to make from this piece of land during the next harvest?

LAW OF SINES

539. The accompanying diagram shows the approximate linear distances traveled by a sailboat during a race. The sailboat started at point *S*, traveled to points *E* and *A*, respectively, and ended at point *S*.

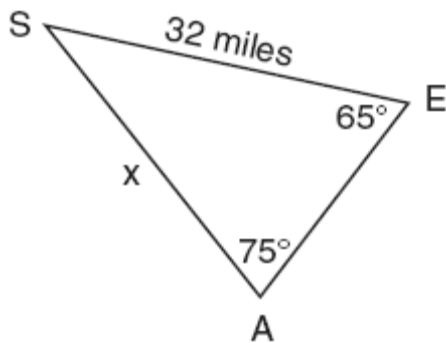

Based on the measures shown in the diagram, which equation can be used to find *x*, the distance from point *A* to point *S*?

- [A] $\frac{\sin 65^\circ}{x} = \frac{\sin 75^\circ}{32}$
 [B] $\frac{x}{\sin 65^\circ} = \frac{\sin 75^\circ}{32}$
 [C] $\frac{65}{x} = \frac{32}{75}$ [D] $\frac{x}{65} = \frac{32}{75}$

540. In $\triangle ABC$, $a = 19$, $c = 10$, and $m\angle A = 111$. Which statement can be used to find the value of $\angle C$?

[A] $\sin C = \frac{19 \sin 69^\circ}{10}$

[B] $\sin C = \frac{10 \sin 21^\circ}{19}$

[C] $\sin C = \frac{10}{19}$ [D] $\sin C = \frac{10 \sin 69^\circ}{19}$

541. In $\triangle ABC$, $m\angle A = 53$, $m\angle B = 14$, and $a = 10$. Find b to the *nearest integer*.

542. In $\triangle ABC$, $m\angle A = 33$, $a = 12$, and $b = 15$. What is $m\angle B$ to the *nearest degree*?

- [A] 41 [B] 43 [C] 48 [D] 44

543. A ski lift begins at ground level 0.75 mile from the base of a mountain whose face has a 50° angle of elevation, as shown in the accompanying diagram. The ski lift ascends in a straight line at an angle of 20° . Find the length of the ski lift from the beginning of the ski lift to the top of the mountain, to the *nearest hundredth of a mile*.

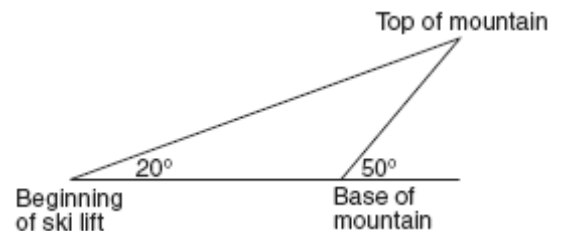

544. In the accompanying diagram of $\triangle ABC$, $m\angle A = 30$, $m\angle C = 50$, and $AC = 13$.

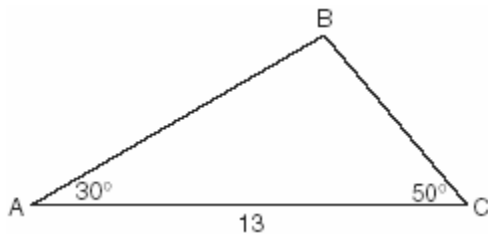

What is the length of side \overline{AB} to the nearest tenth?

- [A] 11.5 [B] 10.1 [C] 12.0 [D] 6.6

545. As shown in the accompanying diagram, two tracking stations, A and B , are on an east-west line 110 miles apart. A forest fire is located at F , on a bearing 42° northeast of station A and 15° northeast of station B . How far, to the nearest mile, is the fire from station A ?

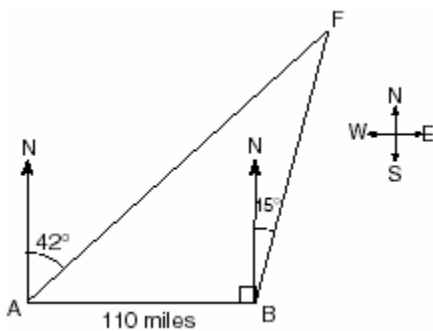

546. In the accompanying diagram of $\triangle ABC$, $m\angle A = 65$, $m\angle B = 70$, and the side opposite vertex B is 7. Find the length of the side opposite vertex A , and find the area of $\triangle ABC$.

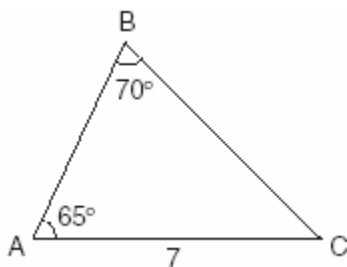

547. Carmen and Jamal are standing 5,280 feet apart on a straight, horizontal road. They observe a hot-air balloon between them directly above the road. The angle of elevation from Carmen is 60° and from Jamal is 75° . Draw a diagram to illustrate this situation and find the height of the balloon to the nearest foot.

548. In the accompanying diagram of a streetlight, the light is attached to a pole at R and supported by a brace, \overline{PQ} , $RQ = 10$ feet, $RP = 6$ feet, $\angle PRQ$ is an obtuse angle, and $m\angle PQR = 30$. Find the length of the brace, \overline{PQ} , to the nearest foot.

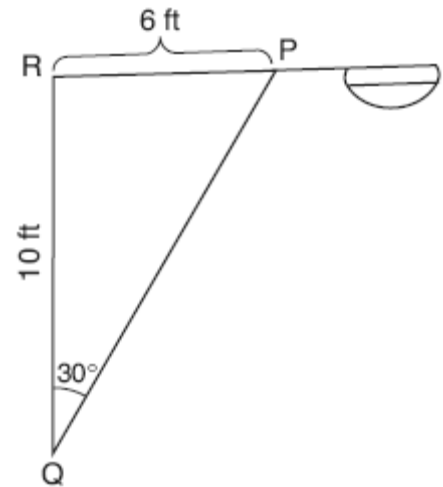

549. A ship at sea heads directly toward a cliff on the shoreline. The accompanying diagram shows the top of the cliff, D , sighted from two locations, A and B , separated by distance S . If $m\angle DAC = 30$, $m\angle DBC = 45$, and $S = 30$ feet, what is the height of the cliff, to the nearest foot?

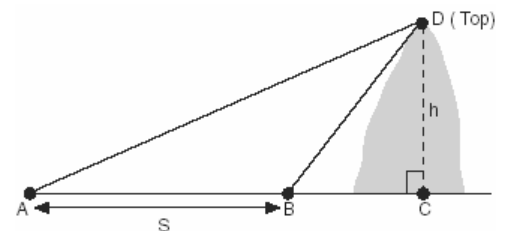

550. The accompanying diagram shows the plans for a cell-phone tower that is to be built near a busy highway. Find the height of the tower, to the *nearest foot*.

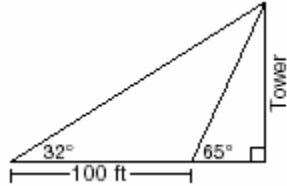

551. A ship captain at sea uses a sextant to sight an angle of elevation of 37° to the top of a lighthouse. After the ship travels 250 feet directly toward the lighthouse, another sighting is made, and the new angle of elevation is 50° . The ship's charts show that there are dangerous rocks 100 feet from the base of the lighthouse. Find, to the *nearest foot*, how close to the rocks the ship is at the time of the second sighting.
552. While sailing a boat offshore, Donna sees a lighthouse and calculates that the angle of elevation to the top of the lighthouse is 3° , as shown in the accompanying diagram. When she sails her boat 700 feet closer to the lighthouse, she finds that the angle of elevation is now 5° . How tall, to the *nearest tenth of a foot*, is the lighthouse?

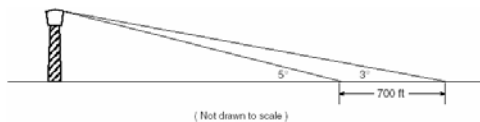

553. A sign 46 feet high is placed on top of an office building. From a point on the sidewalk level with the base of the building, the angle of elevation to the top of the sign and the angle of elevation to the bottom of the sign are 40° and 32° , respectively. Sketch a diagram to represent the building, the sign, and the two angles, and find the height of the building to the *nearest foot*.

USING TRIGONOMETRY TO SOLVE TRIANGLE INEQUALITIES

554. How many distinct triangles can be formed if $m\angle A = 30$, side $b = 12$, and side $a = 8$?
[A] 3 [B] 2 [C] 0 [D] 1
555. What is the total number of distinct triangles that can be constructed if $AC = 13$, $BC = 8$, and $m\angle A = 36$?
[A] 2 [B] 3 [C] 0 [D] 1
556. An architect commissions a contractor to produce a triangular window. The architect describes the window as $\triangle ABC$, where $m\angle A = 50$, $BC = 10$ inches, and $AB = 12$ inches. How many distinct triangles can the contractor construct using these dimensions?
[A] more than 2 [B] 1 [C] 2 [D] 0
557. Sam is designing a triangular piece for a metal sculpture. He tells Martha that two of the sides of the piece are 40 inches and 15 inches, and the angle opposite the 40-inch side measures 120° . Martha decides to sketch the piece that Sam described. How many different triangles can she sketch that match Sam's description?
[A] 1 [B] 0 [C] 3 [D] 2
558. Sam needs to cut a triangle out of a sheet of paper. The only requirements that Sam must follow are that one of the angles must be 60° , the side opposite the 60° angle must be 40 centimeters, and one of the other sides must be 15 centimeters. How many different triangles can Sam make?
[A] 1 [B] 3 [C] 2 [D] 0

559. A landscape designer is designing a triangular garden with two sides that are 4 feet and 6 feet, respectively. The angle opposite the 4-foot side is 30° . How many distinct triangular gardens can the designer make using these measurements?
560. Main Street and Central Avenue intersect, making an angle measuring 34° . Angela lives at the intersection of the two roads, and Caitlin lives on Central Avenue 10 miles from the intersection. If Leticia lives 7 miles from Caitlin, which conclusion is valid?
- [A] Leticia can live at one of two locations on Main Street.
- [B] Leticia cannot live on Main Street.
- [C] Leticia can live at only one location on Main Street.
- [D] Leticia can live at one of three locations on Main Street.
561. In $\triangle ABC$, if $AC = 12$, $BC = 11$, and $m\angle A = 30$, angle C could be
- [A] an acute angle, only
- [B] a right angle, only
- [C] an obtuse angle, only
- [D] either an obtuse angle or an acute angle
562. In $\triangle ABC$, $m\angle A = 30$, $a = 14$, and $b = 20$. Which type of angle is $\angle B$?
- [A] It must be a right angle.
- [B] It must be an acute angle.
- [C] It must be an obtuse angle.
- [D] It may be either an acute angle or an obtuse angle.

VECTORS

563. Two tow trucks try to pull a car out of a ditch. One tow truck applies a force of 1,500 pounds while the other truck applies a force of 2,000 pounds. The resultant force is 3,000 pounds. Find the angle between the two applied forces, rounded to the *nearest degree*.
564. One force of 20 pounds and one force of 15 pounds act on a body at the same point so that the resultant force is 19 pounds. Find, to the *nearest degree*, the angle between the two original forces.
565. Two equal forces act on a body at an angle of 80° . If the resultant force is 100 newtons, find the value of one of the two equal forces, to the *nearest hundredth of a newton*.
566. A jet is flying at a speed of 526 miles per hour. The pilot encounters turbulence due to a 50-mile-per-hour wind blowing at an angle of 47° , as shown in the accompanying diagram.

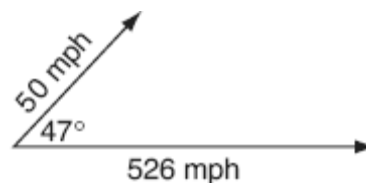

- Find the resultant speed of the jet, to the *nearest tenth of a mile per hour*. Use this answer to find the measure of the angle between the resultant force and the wind vector, to the *nearest tenth of a degree*.
567. Two forces of 40 pounds and 20 pounds, respectively, act simultaneously on an object. The angle between the two forces is 40° . Find the magnitude of the resultant, to the *nearest tenth of a pound*. Find the measure of the angle, to the *nearest degree*, between the resultant and the larger force.

OTHER POLYGONS

PERIMETER AND AREA OF OTHER POLYGONS

568. Chad had a garden that was in the shape of a rectangle. Its length was twice its width. He decided to make a new garden that was 2 feet longer and 2 feet wider than his first garden. If x represents the original width of the garden, which expression represents the difference between the area of his new garden and the area of the original garden?

- [A] $x^2 + 3x + 2$ [B] $6x + 4$
[C] 8 [D] $2x^2$

569. A small, open-top packing box, similar to a shoebox without a lid, is three times as long as it is wide, and half as high as it is long. Each square inch of the bottom of the box costs \$0.008 to produce, while each square inch of any side costs \$0.003 to produce. Write a function for the cost of the box described above. Using this function, determine the dimensions of a box that would cost \$0.69 to produce.

570. A picnic table in the shape of a regular octagon is shown in the accompanying diagram. If the length of \overline{AE} is 6 feet, find the length of one side of the table to the nearest tenth of a foot, and find the area of the table's surface to the nearest tenth of a square foot.

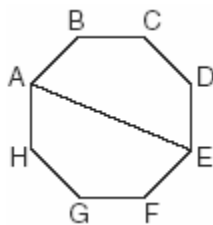

CONICS

CIRCUMFERENCE AND AREA

571. Every time the pedals go through a 360° rotation on a certain bicycle, the tires rotate three times. If the tires are 24 inches in diameter, what is the minimum number of complete rotations of the pedals needed for the bicycle to travel at least 1 mile?

- [A] 12 [B] 5,280 [C] 561 [D] 281

572. Ileana buys a large circular pizza that is divided into eight equal slices. She measures along the outer edge of the crust from one piece and finds it to be $5\frac{1}{2}$ inches. What is the diameter of the pizza to the nearest inch?

- [A] 7 [B] 8 [C] 4 [D] 14

573. A ball is rolling in a circular path that has a radius of 10 inches, as shown in the accompanying diagram. What distance has the ball rolled when the subtended arc is 54° ? Express your answer to the nearest hundredth of an inch.

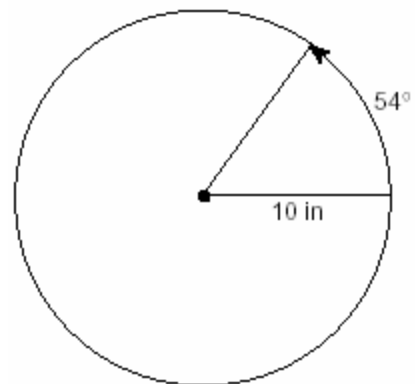

574. Cities H and K are located on the same line of longitude and the difference in the latitude of these cities is 9° , as shown in the accompanying diagram. If Earth's radius is 3,954 miles, how many miles north of city K is city H along arc HK ? Round your answer to the nearest tenth of a mile.

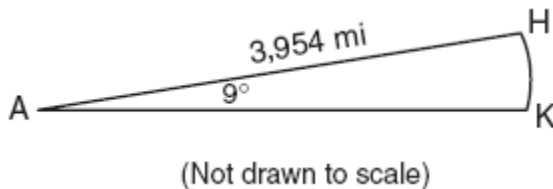

575. The accompanying diagram shows the path of a cart traveling on a circular track of radius 2.40 meters. The cart starts at point A and stops at point B , moving in a counterclockwise direction. What is the length of minor arc AB , over which the cart traveled, to the nearest tenth of a meter?

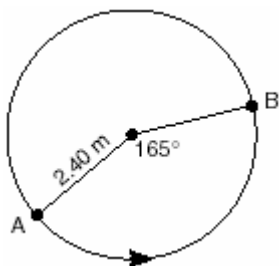

576. Kathy and Tami are at point A on a circular track that has a radius of 150 feet, as shown in the accompanying diagram. They run counterclockwise along the track from A to S , a distance of 247 feet. Find, to the nearest degree, the measure of minor arc AS .

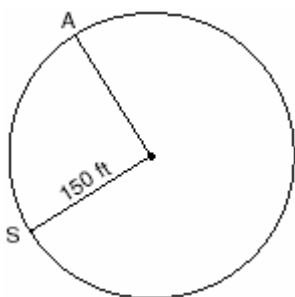

577. As shown in the accompanying diagram, a dial in the shape of a semicircle has a radius of 4 centimeters. Find the measure of θ , in radians, when the pointer rotates to form an arc whose length is 1.38 centimeters.

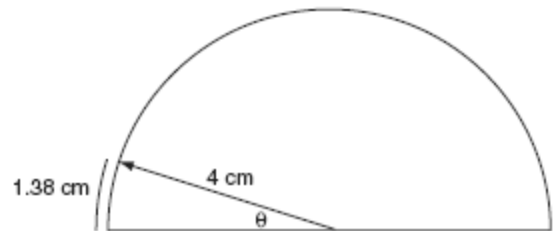

578. Cerise waters her lawn with a sprinkler that sprays water in a circular pattern at a distance of 15 feet from the sprinkler. The sprinkler head rotates through an angle of 300° , as shown by the shaded area in the accompanying diagram.

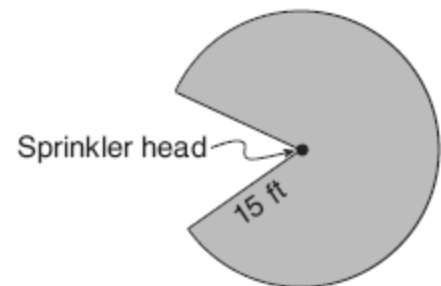

What is the area of the lawn, to the nearest square foot, that receives water from this sprinkler?

- [A] 707 [B] 589 [C] 79 [D] 94

579. The circumference of a circular plot of land is increased by 10%. What is the best estimate of the total percentage that the area of the plot increased?

- [A] 25% [B] 10% [C] 31% [D] 21%

EQUATIONS OF CIRCLES

580. The center of a circular sunflower with a diameter of 4 centimeters is $(-2,1)$. Which equation represents the sunflower?

- [A] $(x-2)^2 + (y+1)^2 = 2$
- [B] $(x+2)^2 + (y-1)^2 = 4$
- [C] $(x-2)^2 + (y-1)^2 = 4$
- [D] $(x+2)^2 + (y-1)^2 = 2$

581. What is the equation of a circle with center $(-3,1)$ and radius 7?

- [A] $(x+3)^2 + (y-1)^2 = 49$
- [B] $(x-3)^2 + (y+1)^2 = 7$
- [C] $(x+3)^2 + (y-1)^2 = 7$
- [D] $(x-3)^2 + (y+1)^2 = 49$

582. Which equation represents the circle shown in the accompanying graph?

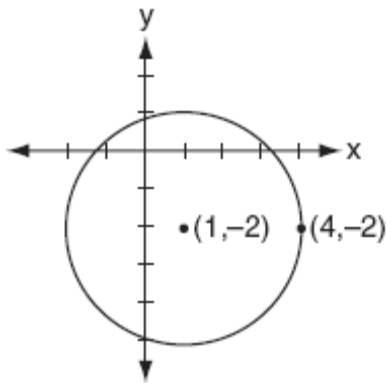

- [A] $(x-1)^2 + (y+2)^2 = 9$
- [B] $(x-1)^2 - (y+2)^2 = 9$
- [C] $(x+1)^2 - (y-2)^2 = 9$
- [D] $(x+1)^2 + (y-2)^2 = 9$

583. For a carnival game, John is painting two circles, V and M , on a square dartboard. a On the accompanying grid, draw and label circle V , represented by the equation $x^2 + y^2 = 25$, and circle M , represented by the equation $(x-8)^2 + (y+6)^2 = 4$.

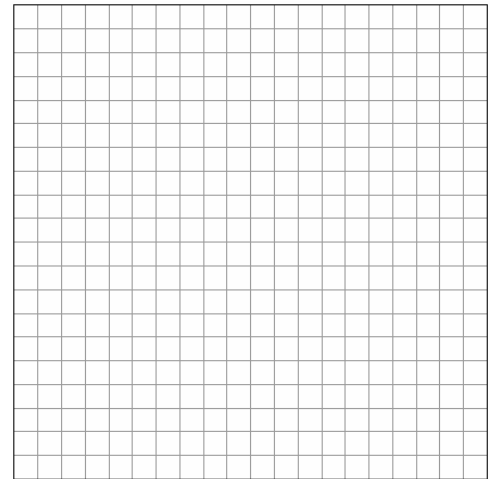

b A point, (x,y) , is randomly selected such that $-10 \leq x \leq 10$ and $-10 \leq y \leq 10$. What is the probability that point (x,y) lies outside both circle V and circle M ?

584. A circle has the equation $(x+1)^2 + (y-3)^2 = 16$. What are the coordinates of its center and the length of its radius?

- [A] $(-1,3)$ and 16
- [B] $(1,-3)$ and 4
- [C] $(-1,3)$ and 4
- [D] $(1,-3)$ and 16

585. What are the coordinates of the center of the circle represented by the equation $(x+3)^2 + (y-4)^2 = 25$?

- [A] $(3,4)$
- [B] $(-3,4)$
- [C] $(-3,-4)$
- [D] $(3,-4)$

586. The center of a circle represented by the equation $(x-2)^2 + (y+3)^2 = 100$ is located in Quadrant

- [A] IV
- [B] III
- [C] I
- [D] II

EQUATIONS OF ELLIPSES

587. An object orbiting a planet travels in a path represented by the equation $3(y+1)^2 + 5(x+4)^2 = 15$. In which type of pattern does the object travel?

[A] circle [B] parabola
[C] ellipse [D] hyperbola

588. The accompanying diagram shows the elliptical orbit of a planet. The foci of the elliptical orbit are F_1 and F_2 .

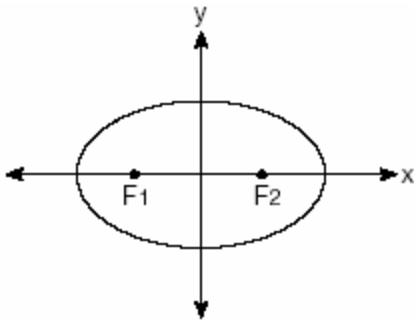

If a , b , and c are all positive and $a \neq b \neq c$, which equation could represent the path of the planet?

[A] $ax^2 - by^2 = c^2$ [B] $y = ax^2 + c^2$
[C] $x^2 + y^2 = c^2$ [D] $ax^2 + by^2 = c^2$

589. Which equation, when graphed on a Cartesian coordinate plane, would best represent an elliptical racetrack?

[A] $3x^2 - 10y^2 = 288,000$
[B] $30xy = 288,000$
[C] $3x^2 + 10y^2 = 288,000$
[D] $3x + 10y = 288,000$

590. A designer who is planning to install an elliptical mirror is laying out the design on a coordinate grid. Which equation could represent the elliptical mirror?

[A] $x^2 + 4y^2 = 144$ [B] $y = 4y^2 + 144$
[C] $x^2 + y^2 = 144$ [D] $x^2 = 144 + 36y^2$

591. The accompanying diagram represents the elliptical path of a ride at an amusement park.

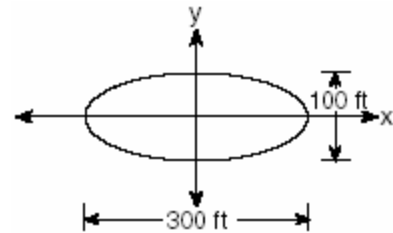

Which equation represents this path?

[A] $x^2 + y^2 = 300$ [B] $\frac{x^2}{150^2} - \frac{y^2}{50^2} = 1$
[C] $\frac{x^2}{150^2} + \frac{y^2}{50^2} = 1$
[D] $y = x^2 + 100x + 300$

592. A commercial artist plans to include an ellipse in a design and wants the length of the horizontal axis to equal 10 and the length of the vertical axis to equal 6. Which equation could represent this ellipse?

[A] $3y = 20x^2$ [B] $x^2 + y^2 = 100$
[C] $9x^2 + 25y^2 = 225$
[D] $9x^2 - 25y^2 = 225$

593. An architect is designing a building to include an arch in the shape of a semi-ellipse (half an ellipse), such that the width of the arch is 20 feet and the height of the arch is 8 feet, as shown in the accompanying diagram.

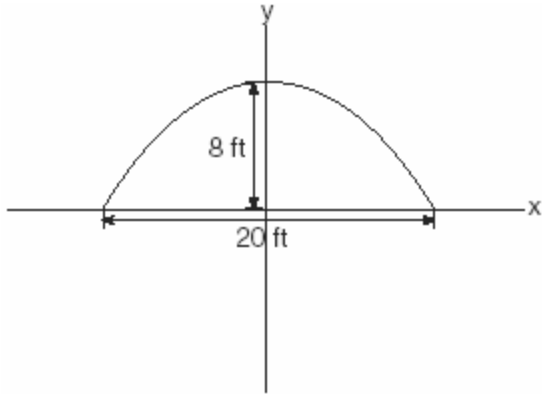

Which equation models this arch?

- [A] $\frac{x^2}{400} + \frac{y^2}{64} = 1$ [B] $\frac{x^2}{100} + \frac{y^2}{64} = 1$
 [C] $\frac{x^2}{64} + \frac{y^2}{400} = 1$ [D] $\frac{x^2}{64} + \frac{y^2}{100} = 1$

594. The accompanying diagram shows the construction of a model of an elliptical orbit of a planet traveling around a star. Point P and the center of the star represent the foci of the orbit.

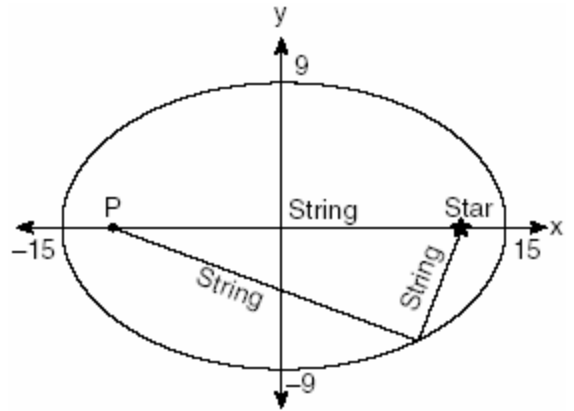

Which equation could represent the relation shown?

- [A] $\frac{x^2}{225} + \frac{y^2}{81} = 1$ [B] $\frac{x^2}{15} + \frac{y^2}{9} = 1$
 [C] $\frac{x^2}{81} + \frac{y^2}{225} = 1$ [D] $\frac{x^2}{15} - \frac{y^2}{9} = 1$

595. A landscape architect is working on the plans for a new horse farm. He is laying out the exercise ring and racetrack on the accompanying graph. The location of the circular exercise ring, with point R as its center, has already been plotted.

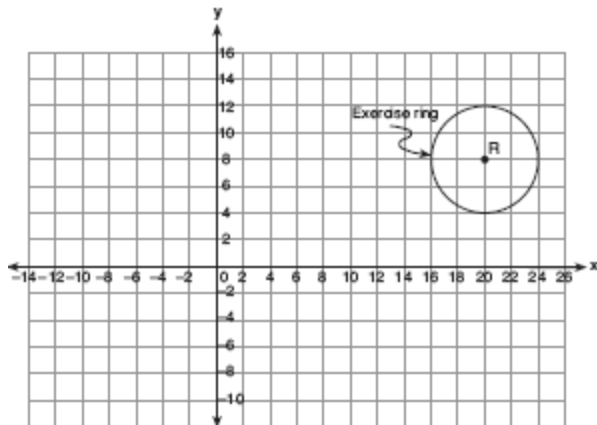

Write an equation that represents the outside edge of the exercise ring. The equation of the outside edge of the racetrack is $\frac{x^2}{144} + \frac{y^2}{36} = 1$.

Sketch the outside edge of the racetrack on the graph.

CHORDS SECANTS AND TANGENTS

596. Kimi wants to determine the radius of a circular pool without getting wet. She is located at point K , which is 4 feet from the pool and 12 feet from the point of tangency, as shown in the accompanying diagram.

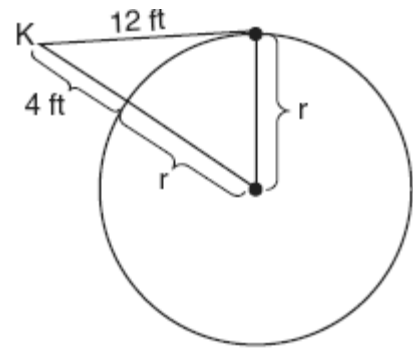

What is the radius of the pool?

- [A] 20 ft [B] $4\sqrt{10}$ ft
[C] 32 ft [D] 16 ft

597. The accompanying diagram represents circular pond O with docks located at points A and B . From a cabin located at C , two sightings are taken that determine an angle of 30° for tangents \overline{CA} and \overline{CB} .

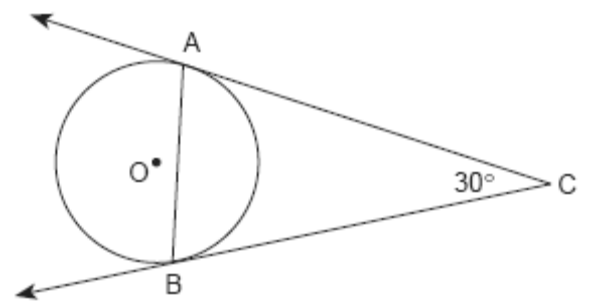

What is $m\angle CAB$?

- [A] 30 [B] 60 [C] 75 [D] 150

598. A small fragment of something brittle, such as pottery, is called a shard. The accompanying diagram represents the outline of a shard from a small round plate that was found at an archaeological dig.



If \overline{BC} is a tangent to \widehat{AC} at B and $m\angle ABC = 45$, what is the measure of \widehat{AC} , the outside edge of the shard?

- [A] 225° [B] 90° [C] 135° [D] 45°

599. The accompanying diagram shows a child's spin toy that is constructed from two chords intersecting in a circle. The curved edge of the larger shaded section is one-quarter of the circumference of the circle, and the curved edge of the smaller shaded section is one-fifth of the circumference of the circle.

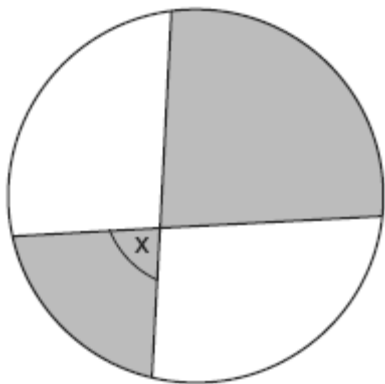

What is the measure of angle x ?

- [A] 108° [B] 72° [C] 40° [D] 81°

600. An overhead view of a revolving door is shown in the accompanying diagram. Each panel is 1.5 meters wide.

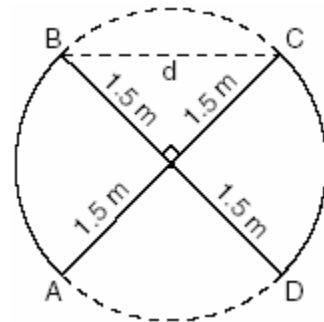

What is the approximate width of d , the opening from B to C ?

- [A] 1.50 m [B] 1.73 m
[C] 3.00 m [D] 2.12 m

601. The accompanying diagram shows a revolving door with three panels, each of which is 4 feet long. What is the width, w , of the opening between x and y , to the nearest tenth of a foot?

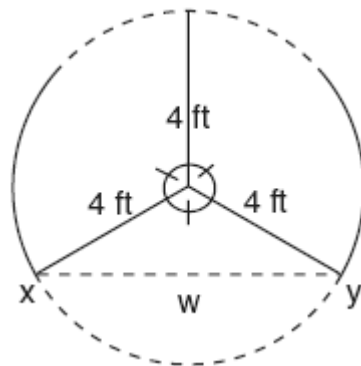

602. In the accompanying diagram of circle O , chords \overline{AB} and \overline{CD} intersect at E . If $AE = 3$, $EB = 4$, $CE = x$, and $ED = x - 4$, what is the value of x ?

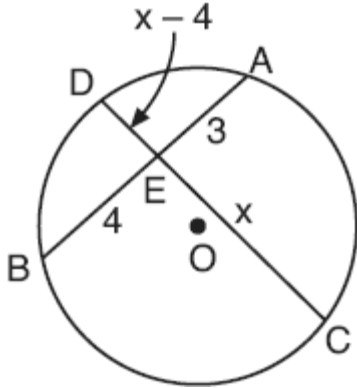

603. A toy truck is located within a circular play area. Alex and Dominic are sitting on opposite endpoints of a chord that contains the truck. Alex is 4 feet from the truck, and Dominic is 3 feet from the truck. Meira and Tamara are sitting on opposite endpoints of another chord containing the truck. Meira is 8 feet from the truck. How many feet, to the nearest tenth of a foot, is Tamara from the truck? Draw a diagram to support your answer.

604. In the accompanying diagram, the length of \widehat{ABC} is $\frac{3\pi}{2}$ radians.

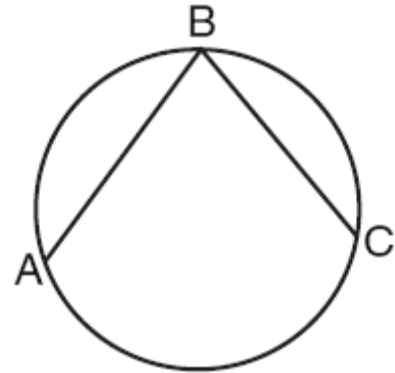

(Not drawn to scale)

What is $m\angle ABC$?

- [A] 45 [B] 36 [C] 53 [D] 72

605. In the accompanying diagram of circle O , chord \overline{AY} is parallel to diameter \overline{DOE} , \overline{AD} is drawn, and $m\widehat{AD} = 40$.

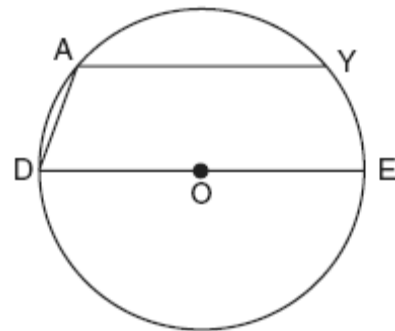

What is $m\angle DAY$?

- [A] 110 [B] 90 [C] 150 [D] 130

606. The new corporate logo created by the design engineers at Magic Motors is shown in the accompanying diagram.

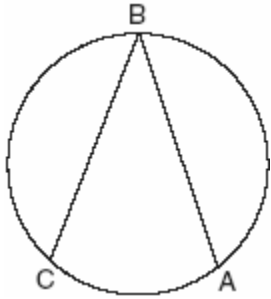

If chords \overline{BA} and \overline{BC} are congruent and $m\widehat{BC} = 140$, what is $m\angle B$?

- [A] 40 [B] 140 [C] 80 [D] 280

607. A machine part consists of a circular wheel with an inscribed triangular plate, as shown in the accompanying diagram. If $\overline{SE} \cong \overline{EA}$, $SE = 10$, and $m\widehat{SE} = 140$, find the length of \overline{SA} to the nearest tenth.

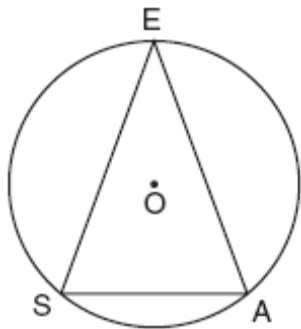

608. A regular hexagon is inscribed in a circle. What is the ratio of the length of a side of the hexagon to the minor arc that it intercepts?

- [A] $\frac{6}{\pi}$ [B] $\frac{\pi}{6}$ [C] $\frac{3}{6}$ [D] $\frac{3}{\pi}$

609. In the accompanying diagram of circle O , diameter \overline{AOB} is extended through B to external point P , tangent \overline{PC} is drawn to point C on the circle, and $m\widehat{AC} : m\widehat{BC} = 7 : 2$. Find $m\angle CPA$.

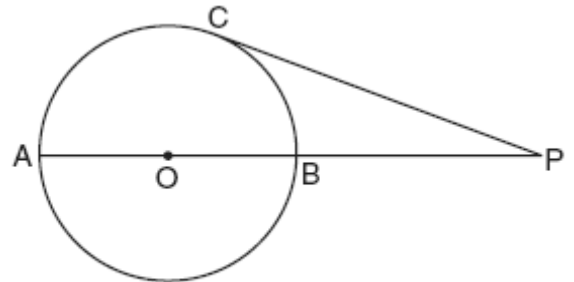

(Not drawn to scale)

610. Point P lies outside circle O , which has a diameter of \overline{AOC} . The angle formed by tangent \overline{PA} and secant \overline{PBC} measures 30° . Sketch the conditions given above and find the number of degrees in the measure of minor arc CB .
611. In the accompanying diagram, cabins B and G are located on the shore of a circular lake, and cabin L is located near the lake. Point D is a dock on the lake shore and is collinear with cabins B and L . The road between cabins G and L is 8 miles long and is tangent to the lake. The path between cabin L and dock D is 4 miles long.

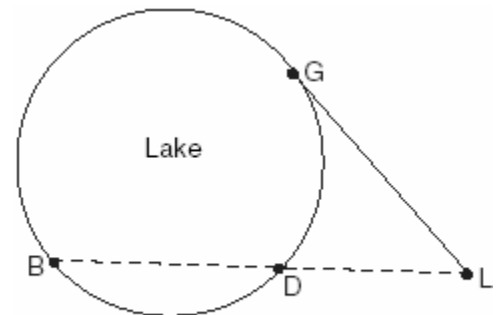

(Not drawn to scale)

What is the length, in miles, of \overline{BD} ?

- [A] 24 [B] 12 [C] 8 [D] 4

612. The accompanying diagram shows a circular machine part that has rods \overline{PT} and \overline{PAR} attached at points T , A , and R , which are located on the circle;
 $m\widehat{TA} : m\widehat{AR} : m\widehat{RT} = 1 : 3 : 5$; $RA = 12$ centimeters; and $PA = 5$ centimeters.

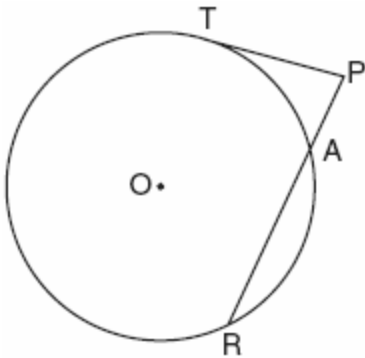

Find the measure of $\angle P$, in degrees, and find the length of rod \overline{PT} , to the nearest tenth of a centimeter.

613. In the accompanying diagram, \overline{PA} is tangent to circle O at A , \overline{PBC} is a secant, $PB = 4$, and $BC = 8$.

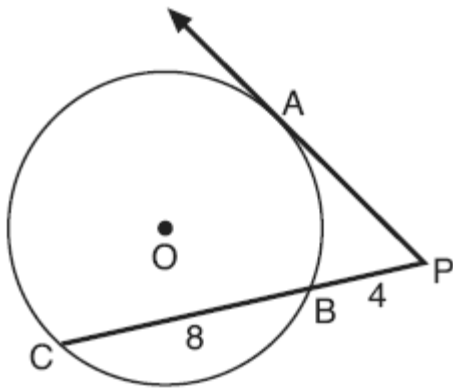

What is the length of \overline{PA} ?

- [A] $4\sqrt{2}$ [B] $4\sqrt{6}$ [C] 4 [D] $4\sqrt{3}$

614. In the accompanying diagram, \overline{PA} is tangent to circle O at A , secant \overline{PBC} is drawn, $PB = 4$, and $BC = 12$. Find PA .

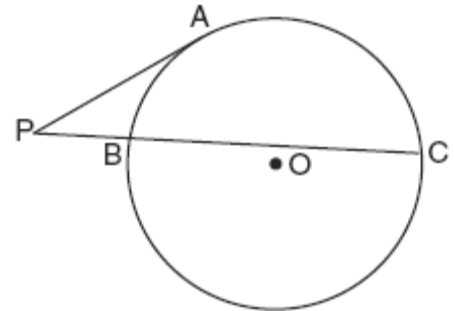

615. An architect is designing a park with an entrance represented by point C and a circular garden with center O , as shown in the accompanying diagram. The architect plans to connect three points on the circumference of the garden, A , B , and D , to the park entrance, C , with walkways so that walkways \overline{CA} and \overline{CB} are tangent to the garden, walkway \overline{DOEC} is a path through the center of the garden, $m\widehat{ADB} : m\widehat{AEB} = 3 : 2$, $BC = 60$ meters, and $EC = 43.6$ meters. Find the measure of the angle between walkways \overline{CA} and \overline{CB} . Find the diameter of the circular garden, to the nearest meter.

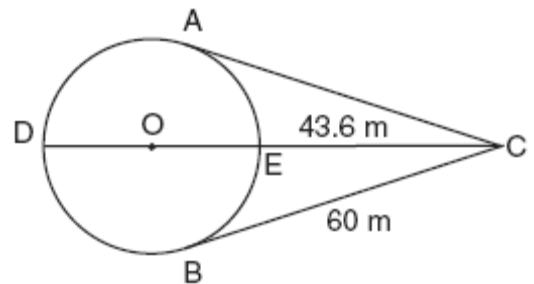

616. Given circle O with diameter \overline{GOAL} ; secants \overline{HUG} and \overline{HTAM} intersect at point H ; $m\widehat{GM} : m\widehat{ML} : m\widehat{LT} = 7 : 3 : 2$; and chord $\overline{GU} \cong$ chord \overline{UT} . Find the ratio of $m\angle UGL$ to $m\angle H$.

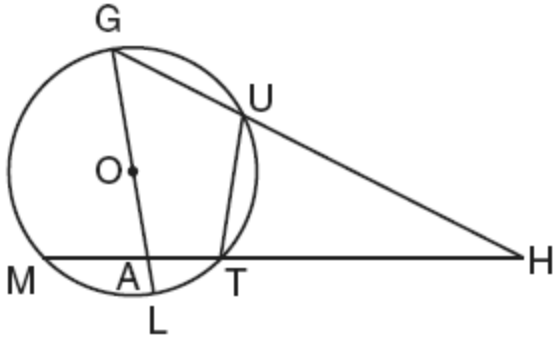

617. In the accompanying diagram, circle O has radius \overline{OD} , diameter \overline{BOHF} , secant \overline{CBA} , and chords \overline{DHG} and \overline{BD} ; \overline{CE} is tangent to circle O at D ; $m\widehat{DF} = 80$; and $m\widehat{BA} : m\widehat{AG} : m\widehat{GF} = 3 : 2 : 1$. Find $m\widehat{GF}$, and $m\angle BHD$, $m\angle BDG$, $m\angle GDE$, $m\angle C$, and $m\angle BOD$.

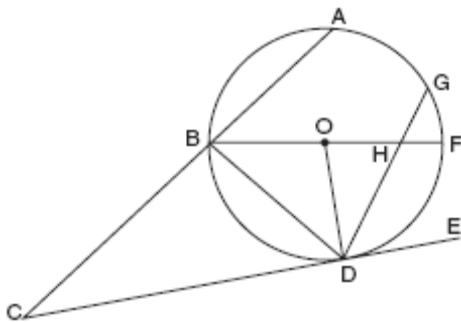

SOLIDS AND SIMILARITY

VOLUME

618. A rectangular piece of cardboard is to be formed into an uncovered box. The piece of cardboard is 2 centimeters longer than it is wide. A square that measures 3 centimeters on a side is cut from each corner. When the sides are turned up to form the box, its volume is 765 cubic centimeters. Find the dimensions, in centimeters, of the original piece of cardboard.
619. Denise is designing a storage box in the shape of a cube. Each side of the box has a length of 10 inches. She needs more room and decides to construct a larger box in the shape of a cube with a volume of 2,000 cubic inches. By how many inches, to the *nearest tenth*, should she *increase* the length of each side of the original box?

SIMILARITY

620. The accompanying diagram shows a 24-foot ladder leaning against a building. A steel brace extends from the ladder to the point where the building meets the ground. The brace forms a right angle with the ladder.

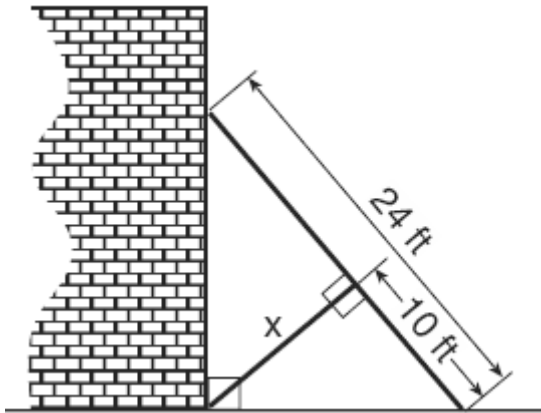

If the steel brace is connected to the ladder at a point that is 10 feet from the foot of the ladder, which equation can be used to find the length, x , of the steel brace?

- [A] $\frac{10}{x} = \frac{x}{24}$ [B] $10^2 + x^2 = 14^2$
 [C] $10^2 + x^2 = 24^2$ [D] $\frac{10}{x} = \frac{x}{14}$

TRANSFORMATIONS

SYMMETRY

621. The graph of which function is symmetric with respect to the graph of the line $y = x$?
- [A] $y = \log x$ [B] $y = x^3$
 [C] $y = \frac{1}{x}$ [D] $y = x^2$

IDENTIFYING TRANSFORMATIONS

622. Which transformation of the graph of $y = x^2$ would result in the graph of $y = x^2 + 2$?
- [A] $r_{y=2}$ [B] D_2 [C] $T_{0,2}$ [D] $R_{0,90}$

TRANSLATIONS

623. The image of the origin under a certain translation is the point $(2,-6)$. The image of point $(-3,-2)$ under the same translation is the point
- [A] $(-1,-8)$ [B] $(-6,12)$
 [C] $(-\frac{3}{2}, \frac{1}{3})$ [D] $(-5,4)$
624. Two parabolic arches are to be built. The equation of the first arch can be expressed as $y = -x^2 + 9$, with a range of $0 \leq y \leq 9$, and the second arch is created by the transformation $T_{7,0}$. On the accompanying set of axes, graph the equations of the two arches. Graph the line of symmetry formed by the parabola and its transformation and label it with the proper equation.

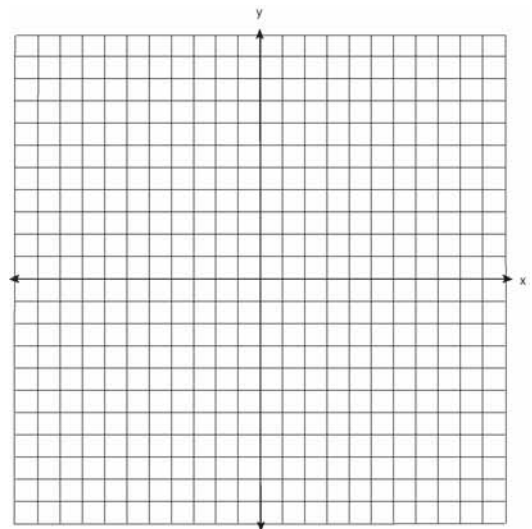

DILATIONS

625. Which transformation represents a dilation?
 [A] $(8,4) \rightarrow (4,2)$ [B] $(8,4) \rightarrow (-4,-8)$
 [C] $(8,4) \rightarrow (11,7)$ [D] $(8,4) \rightarrow (-8,4)$
626. In which quadrant would the image of point $(5,-3)$ fall after a dilation using a factor of -3 ?
 [A] III [B] IV [C] I [D] II
627. Under a dilation with respect to the origin, the image of $P(-15,6)$ is $P'(-5,2)$. What is the constant of dilation?
 [A] 3 [B] -4 [C] $\frac{1}{3}$ [D] 10
628. The graph of the function $g(x)$ is shown on the accompanying set of axes. On the same set of axes, sketch the image of $g(x)$ under the transformation D_2 .

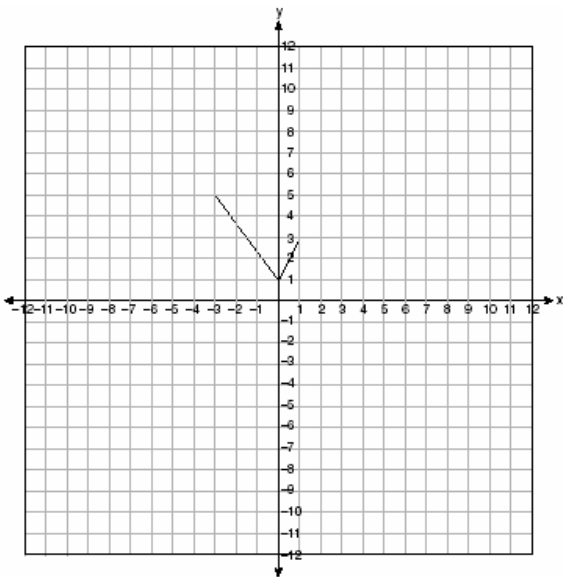

629. In the accompanying graph, the shaded region represents set A of all points (x,y) such that $x^2 + y^2 \leq 1$. The transformation T maps point (x, y) to point $(2x, 4y)$.

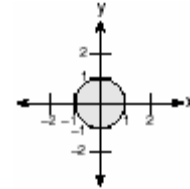

Which graph shows the mapping of set A by the transformation T ?

- [A]
- [B]
- [C]
- [D]

REFLECTIONS

630. What are the coordinates of point P , the image of point $(3,-4)$ after a reflection in the line $y = x$?

[A] $(-4,3)$ [B] $(4,-3)$

[C] $(-3,4)$ [D] $(3,4)$

631. A function, f , is defined by the set $\{(2,3), (4,7), (-1,5)\}$. If f is reflected in the line $y = x$, which point will be in the reflection?

[A] $(-5,1)$ [B] $(-1,5)$

[C] $(5-1)$ [D] $(1-5)$

632. Which transformation best describes the relationship between the functions $f(x) = 2^x$ and $g(x) = \left(\frac{1}{2}\right)^x$?

[A] reflection in the origin

[B] reflection in the line $y = x$

[C] reflection in the x -axis

[D] reflection in the y -axis

633. In the accompanying diagram of square $ABCD$, F is the midpoint of \overline{AB} , G is the midpoint of \overline{BC} , H is the midpoint of \overline{CD} , and E is the midpoint of \overline{DA} .

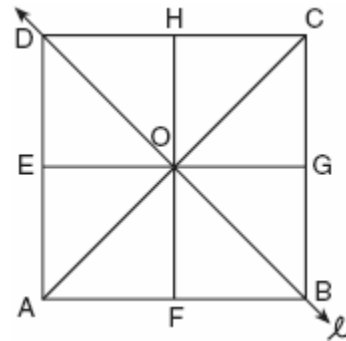

Find the image of $\triangle EOA$ after it is reflected in line l .

Is this isometry direct or opposite? Explain your answer.

634. The accompanying graph represents the equation $y = f(x)$.

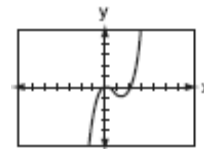

Which graph represents $g(x)$, if $g(x) = -f(x)$?

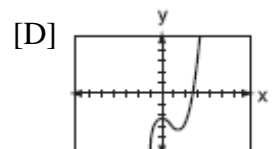
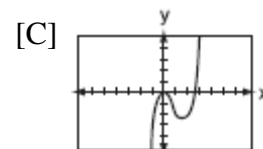
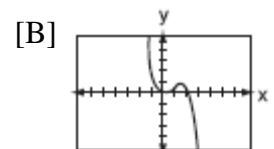
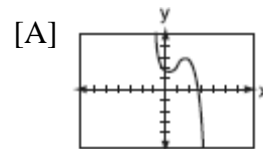

635. The graph below represents $f(x)$.



Which graph best represents $f(-x)$?

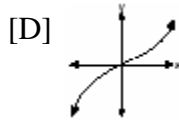
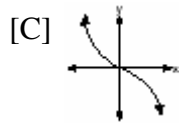
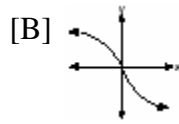
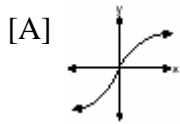

636. The graph of the function $f(x) = a^x$ is shown on the accompanying set of axes. On the same set of axes, sketch the reflection of $f(x)$ in the y -axis. State the coordinates of the point where the graphs intersect.

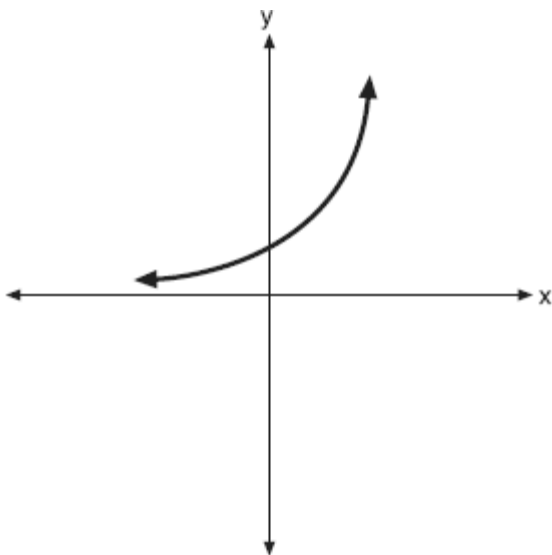

ISOMETRIES

637. Which transformation is *not* an isometry?
 [A] $T_{3,6}$ [B] $r_{y=x}$ [C] $R_{0,90^\circ}$ [D] D_2
638. Which transformation is *not* an isometry?
 [A] line reflection [B] rotation
 [C] dilation [D] translation

639. Which transformation is a direct isometry?
 [A] D_{-2} [B] $T_{2,5}$ [C] D_2 [D] r_{y-axis}
640. Which transformation is an opposite isometry?
 [A] line reflection [B] rotation of 90°
 [C] translation [D] dilation
641. Which transformation is an example of an opposite isometry?
 [A] $(x,y) \rightarrow (x + 3,y - 6)$
 [B] $(x,y) \rightarrow (3x,3y)$
 [C] $(x,y) \rightarrow (y,x)$ [D] $(x,y) \rightarrow (y,-x)$
642. Which transformation does *not* preserve orientation?
 [A] dilation
 [B] reflection in the y -axis
 [C] translation [D] rotation

ROTATIONS

643. Point P' is the image of point $P(-3,4)$ after a translation defined by $T_{(7,-1)}$. Which other transformation on P would also produce P' ?
 [A] $r_{y=-x}$ [B] R_{90°
 [C] r_{y-axis} [D] R_{-90°

COMPOSITIONS OF TRANSFORMATIONS

644. If the coordinates of point A are $(-2,3)$, what is the image of A under $r_{y-axis} \circ D_3$?
 [A] $(-6,-9)$ [B] $(6,9)$
 [C] $(9,-6)$ [D] $(5,6)$

645. The coordinates of $\triangle JRB$ are $J(1,-2)$, $R(-3,6)$, and $B(4,5)$. What are the coordinates of the vertices of its image after the transformation $T_{2,-1} \circ r_{y\text{-axis}}$?

- [A] (1,-3), (5,5), (-2,4)
- [B] (-1,-2), (3,6), (-4,5)
- [C] (3,-3), (-1,5), (6,4)
- [D] (3,1), (-1,-7), (6,-6)

646. What is the image of point (1,1) under $r_{x\text{-axis}} \circ R_{0,90^\circ}$?

- [A] (-1,1) [B] (1,-1)
- [C] (-1,-1) [D] (1,1)

647. What are the coordinates of point A' , the image of point $A(-4,1)$ after the composite transformation $R_{90^\circ} \circ r_{y=x}$ where the origin is the center of rotation?

- [A] (-1,-4) [B] (1,4)
- [C] (4,1) [D] (-4,-1)

648. If $f(x) = \cos x$, which graph represents $f(x)$ under the composition $r_{y\text{-axis}} \circ r_{x\text{-axis}}$?

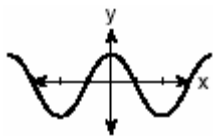
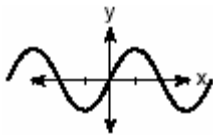
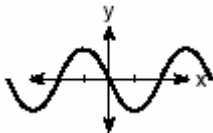
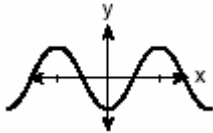
- [A]  [B] 
- [C]  [D] 

649. The graph of $f(x)$ is shown in the accompanying diagram.

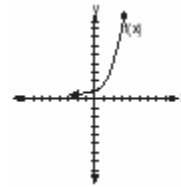

Which graph represents $f(x)_{r_{x\text{-axis}} \circ r_{y\text{-axis}}}$?

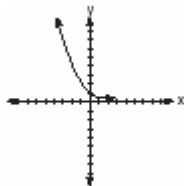
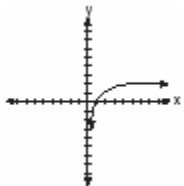
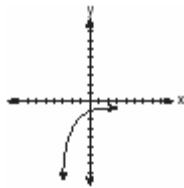
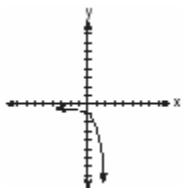
- [A]  [B] 
- [C]  [D] 

650. The accompanying graph represents the figure \square .

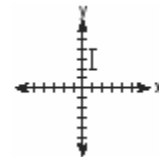

Which graph represents \square after a transformation defined by $r_{y=x} \circ R_{90^\circ}$?

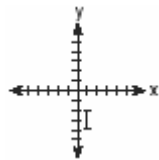
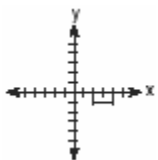
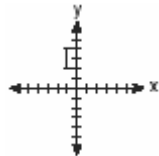
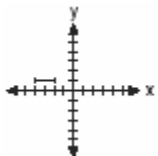
- [A]  [B] 
- [C]  [D] 

651. a On the accompanying grid, graph the equation $2y = 2x^2 - 4$ in the interval $-3 \leq x \leq 3$ and label it a .
b On the same grid, sketch the image of a under $T_{5,-2} \circ r_{x\text{-axis}}$ and label it b .

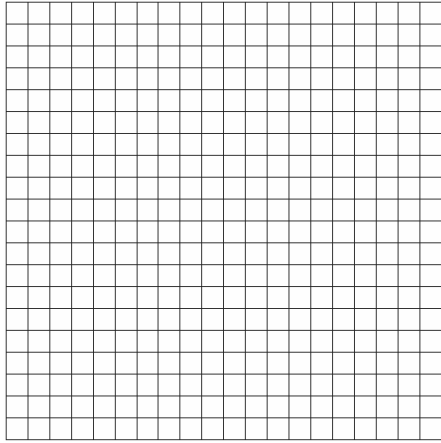

652. Graph and label the following equations, a and b , on the accompanying set of coordinate axes.

$$a: y = x^2$$

$$b: y = -(x-4)^2 + 3$$

Describe the composition of transformations performed on a to get b .

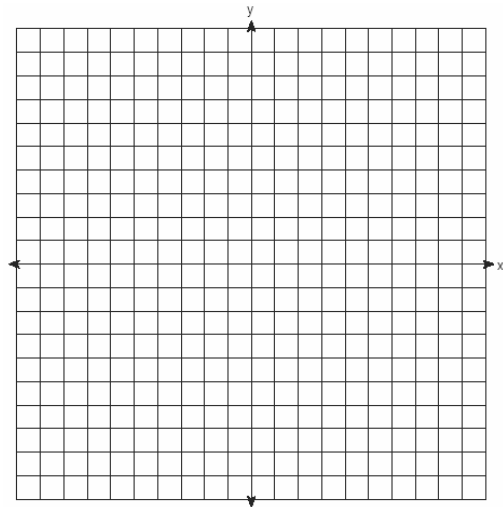

653. On the accompanying grid, graph and label \overline{AB} , where A is $(0,5)$ and B is $(2,0)$. Under the transformation $r_{x\text{-axis}} \circ r_{y\text{-axis}}(\overline{AB})$, A maps to A'' and B maps to B'' . Graph and label $\overline{A''B''}$. What single transformation would map \overline{AB} to $\overline{A''B''}$?

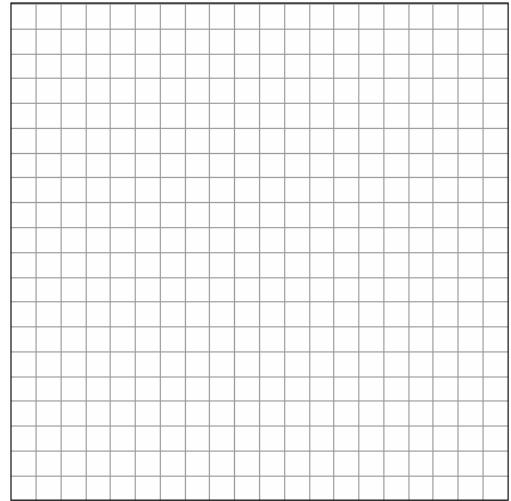

654. Given point $A(-2,3)$. State the coordinates of the image of A under the composition $T_{-3,-4} \circ r_{x\text{-axis}}$. [The use of the accompanying grid is optional.]

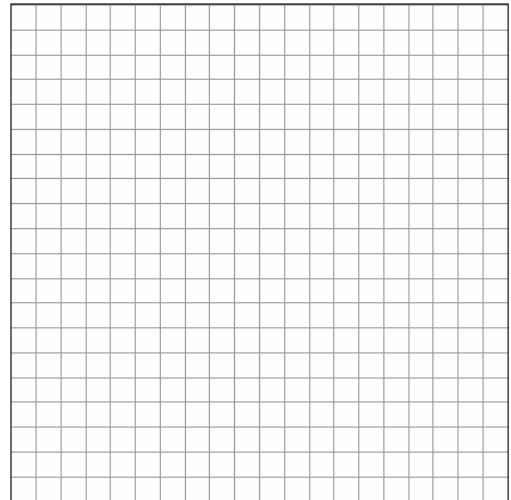

LOGIC

PROOFS

655. Given: quadrilateral $ABCD$ with vertices $A(-2,2)$, $B(8,-4)$, $C(6,-10)$, and $D(-4,-4)$. State the coordinates of $A'B'C'D'$, the image of quadrilateral $ABCD$ under a dilation of factor $\frac{1}{2}$. Prove that $A'B'C'D'$ is a parallelogram. [The use of the grid is optional.]

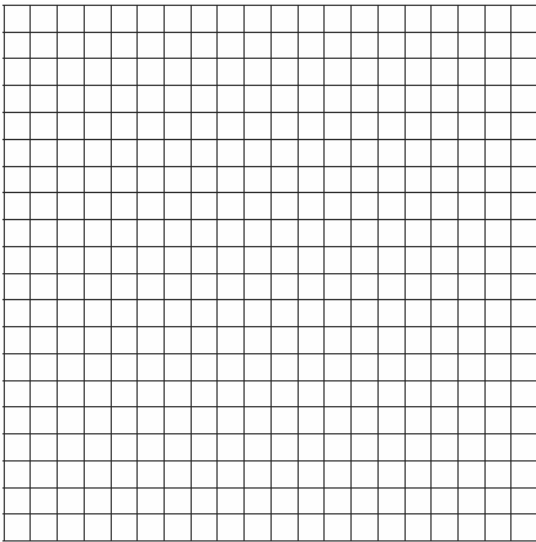

656. Given: $A(-2,2)$, $B(6,5)$, $C(4,0)$, $D(-4,-3)$
Prove: $ABCD$ is a parallelogram but not a rectangle. [The use of the grid is optional.]

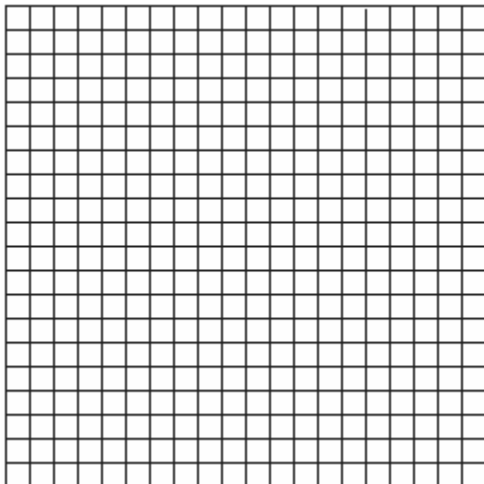

657. The coordinates of quadrilateral $ABCD$ are $A(-1,-5)$, $B(8,2)$, $C(11,13)$, and $D(2,6)$. Using coordinate geometry, prove that quadrilateral $ABCD$ is a rhombus. [The use of the grid is optional.]

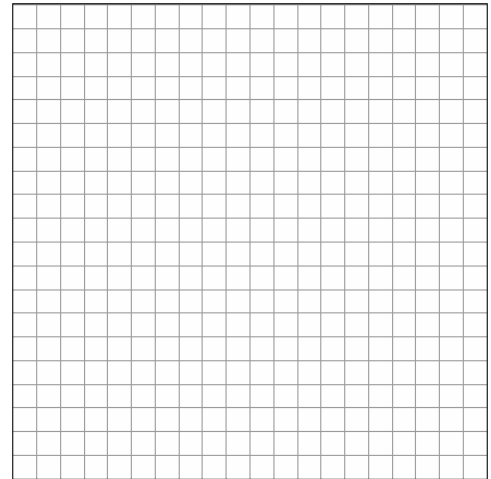

658. Jim is experimenting with a new drawing program on his computer. He created quadrilateral $TEAM$ with coordinates $T(-2,3)$, $E(-5,-4)$, $A(2,-1)$, and $M(5,6)$. Jim believes that he has created a rhombus but not a square. Prove that Jim is correct. [The use of the grid is optional.]

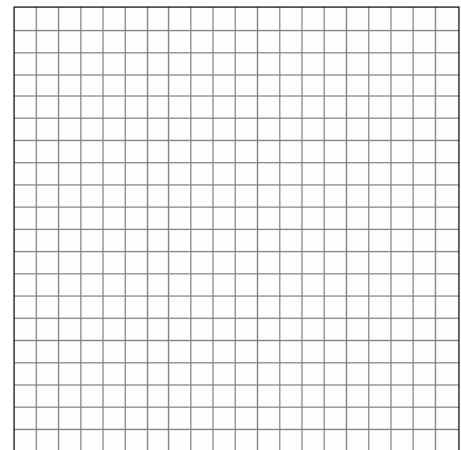

659. Given: $A(1,6)$, $B(7,9)$, $C(13,6)$, and $D(3,1)$
Prove: $ABCD$ is a trapezoid. [The use of the accompanying grid is optional.]

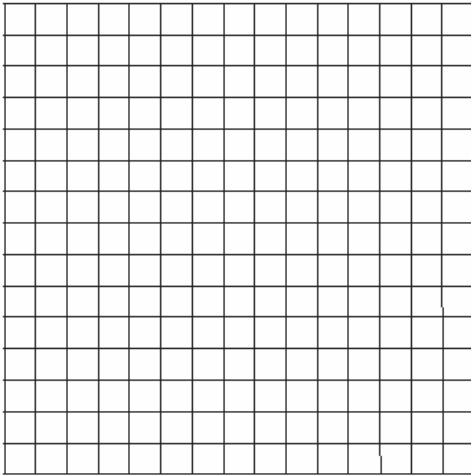

660. Quadrilateral $KATE$ has vertices $K(1,5)$, $A(4,7)$, $T(7,3)$, and $E(1,-1)$.
a Prove that $KATE$ is a trapezoid. [The use of the grid is optional.]
b Prove that $KATE$ is *not* an isosceles trapezoid.

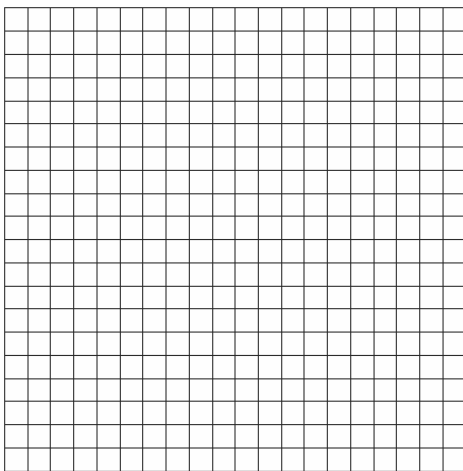

661. The coordinates of quadrilateral $JKLM$ are $J(1,-2)$, $K(13,4)$, $L(6,8)$, and $M(-2,4)$. Prove that quadrilateral $JKLM$ is a trapezoid but not an isosceles trapezoid. [The use of the grid is optional.]

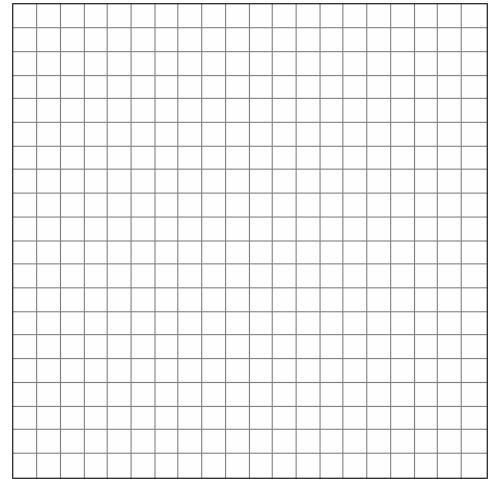

662. In the accompanying diagram of $ABCD$, where $a \neq b$, prove $ABCD$ is an isosceles trapezoid.

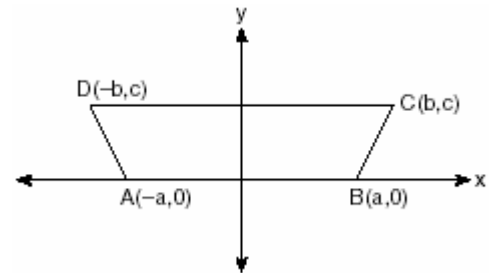

663. In the accompanying diagram of $\triangle ABC$,
 $\overline{AB} \cong \overline{AC}$, $\overline{BD} = \frac{1}{3}\overline{BA}$, and $\overline{CE} = \frac{1}{3}\overline{CA}$.

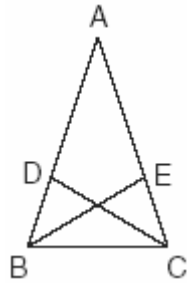

Triangle EBC can be proved congruent to triangle DCB by

- [A] $SSS \cong SSS$ [B] $HL \cong HL$
[C] $ASA \cong ASA$ [D] $SAS \cong SAS$
664. In the accompanying diagram, $\overline{CA} \perp \overline{AB}$,
 $\overline{ED} \perp \overline{DF}$, $\overline{ED} \parallel \overline{AB}$, $\overline{CE} \cong \overline{BF}$, $\overline{AB} \cong \overline{ED}$
and $m\angle CAB = m\angle FDE = 90$.

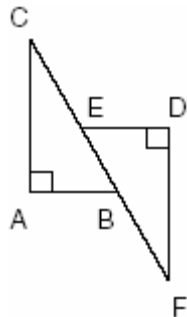

Which statement would *not* be used to prove $\triangle ABC \cong \triangle DEF$?

- [A] $SAS \cong SAS$ [B] $AAS \cong AAS$
[C] $HL \cong HL$ [D] $SSS \cong SSS$

665. In the accompanying diagram of parallelogram $ABCD$, $\overline{DE} \cong \overline{BF}$.

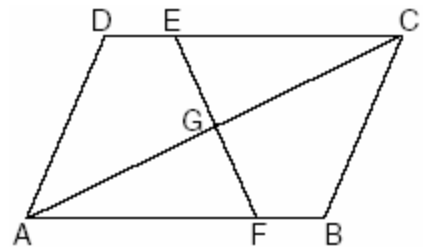

Triangle EGC can be proved congruent to triangle FGA by

- [A] $SSA \cong SSA$ [B] $AAA \cong AAA$
[C] $AAS \cong AAS$ [D] $HL \cong HL$

666. In the accompanying diagram, \overline{HK} bisects \overline{IL} and $\angle H \cong \angle K$.

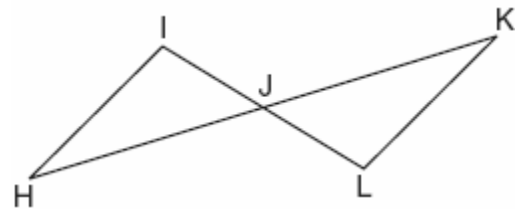

What is the most direct method of proof that could be used to prove $\triangle HIJ \cong \triangle KLJ$?

- [A] $ASA \cong ASA$ [B] $SAS \cong SAS$
[C] $HL \cong HL$ [D] $AAS \cong AAS$

667. Which condition does *not* prove that two triangles are congruent?

- [A] $SAS \cong SAS$ [B] $SSA \cong SSA$
[C] $SSS \cong SSS$ [D] $ASA \cong ASA$

668. Which statements could be used to prove that $\triangle ABC$ and $\triangle A'B'C'$ are congruent?

- [A] $\angle A \cong \angle A'$, $\overline{AC} \cong \overline{A'C'}$, and $\overline{BC} \cong \overline{B'C'}$
[B] $\overline{AB} \cong \overline{A'B'}$, $\angle A \cong \angle A'$, and $\angle C \cong \angle C'$
[C] $\angle A \cong \angle A'$, $\angle B \cong \angle B'$, and $\angle C \cong \angle C'$
[D] $\overline{AB} \cong \overline{A'B'}$, $\overline{BC} \cong \overline{B'C'}$, and $\angle A \cong \angle A'$

669. The accompanying diagram shows quadrilateral $BRON$, with diagonals \overline{NR} and \overline{BO} , which bisect each other at X .

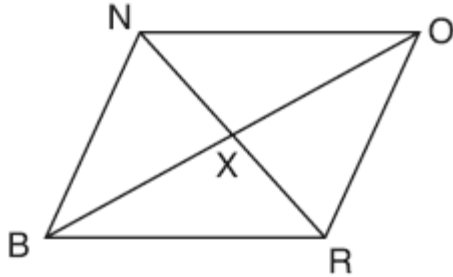

Prove: $\triangle BNX \cong \triangle ORX$

670. Given: parallelogram $FLSH$, diagonal \overline{FGAS} , $\overline{LG} \perp \overline{FS}$, $\overline{HA} \perp \overline{FS}$

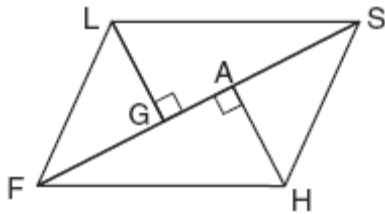

Prove: $\triangle LGS \cong \triangle HAF$

671. In the accompanying diagram of circle O , diameter \overline{AOB} is drawn, tangent \overline{CB} is drawn to the circle at B , E is a point on the circle, and $\overline{BE} \parallel \overline{ADC}$.

Prove: $\triangle ABE \cong \triangle CAB$

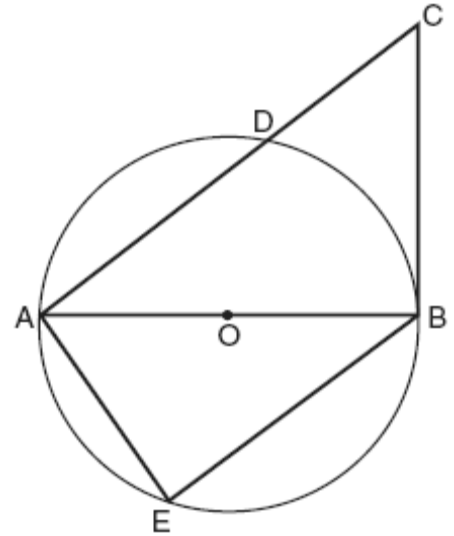

- 672.

Complete the partial proof below for the accompanying diagram by providing reasons for steps 3, 6, 8, and 9.

- Given: \overline{AFCD}
 $\overline{AB} \perp \overline{BC}$
 $\overline{DE} \perp \overline{EF}$
 $\overline{BC} \parallel \overline{FE}$
 $\overline{AB} = \overline{DE}$

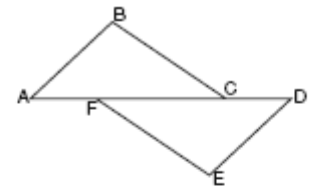

Prove: $\overline{AC} = \overline{FD}$

Statements	Reasons
1 \overline{AFCD}	1 Given
2 $\overline{AB} \perp \overline{BC}$, $\overline{DE} \perp \overline{EF}$	2 Given
3 $\angle B$ and $\angle E$ are right angles.	3 _____
4 $\angle B = \angle E$	4 All right angles are congruent.
5 $\overline{BC} \parallel \overline{FE}$	5 Given
6 $\angle BCA = \angle FED$	6 _____
7 $\overline{AB} = \overline{DE}$	7 Given
8 $\triangle ABC = \triangle DEF$	8 _____
9 $\overline{AC} = \overline{FD}$	9 _____

673. In the accompanying diagram, $m\widehat{BR} = 70$, $m\widehat{YD} = 70$, and \overline{BOD} is the diameter of circle O . Write an explanation or a proof that shows $\triangle RBD$ and $\triangle YDB$ are congruent.

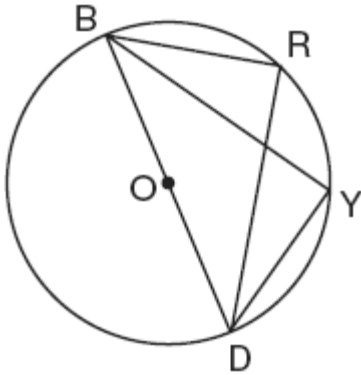

674. Given: chords \overline{AB} and \overline{CD} of circle O intersect at E , an interior point of circle O ; chords \overline{AD} and \overline{CB} are drawn.

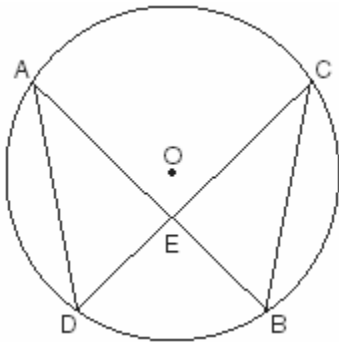

Prove: $(AE)(EB) = (CE)(ED)$

675. Prove that the diagonals of a parallelogram bisect each other.
676. In $\triangle ABC$, D is a point on \overline{AC} such that \overline{BD} is a median. Which statement must be true?
- [A] $\overline{AD} \cong \overline{CD}$ [B] $\angle ABD \cong \angle CBD$
- [C] $\triangle ABD \cong \triangle CBD$ [D] $\overline{BD} \perp \overline{AC}$

677. In the accompanying diagram, $\triangle ABC$ is *not* isosceles. Prove that if altitude \overline{BD} were drawn, it would *not* bisect \overline{AC} .

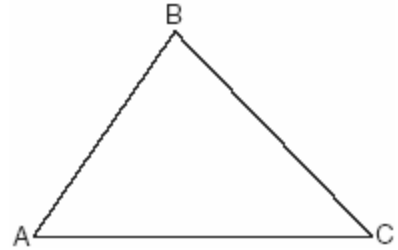

678. Given: parallelogram $ABCD$, diagonal \overline{AC} , and \overline{ABE}

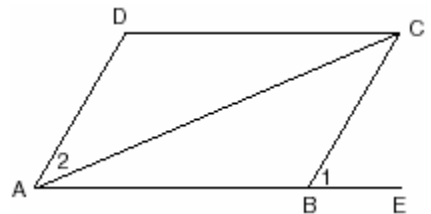

Prove: $m\angle 1 > m\angle 2$

679. Given: $\triangle ABT$, \overline{CBTD} , and $\overline{AB} \perp \overline{CD}$

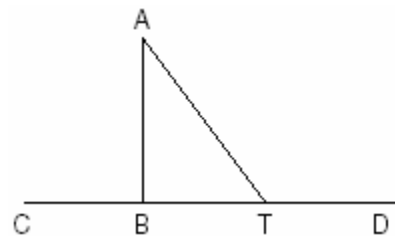

Write an indirect proof to show that \overline{AT} is *not* perpendicular to \overline{CD} .

680. In the accompanying diagram of circle O , \overline{PA} is drawn tangent to the circle at A . Place B on \overline{PA} anywhere between P and A and draw \overline{OA} , \overline{OP} , and \overline{OB} . Prove that \overline{OB} is not perpendicular to \overline{PA} .

