

# JEFFERSON MATH PROJECT

## REGENTS BY DATE

All 21 NY Math A Regents Exams  
from June 1999 to June 2006

[www.jmap.org](http://www.jmap.org)

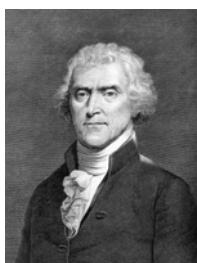

*Dear Sir*

*I have to acknowledge the receipt of your favor of May 14. in which you mention that you have finished the 6. first books of Euclid, plane trigonometry, surveying & algebra and ask whether I think a further pursuit of that branch of science would be useful to you. there are some propositions in the latter books of Euclid, & some of Archimedes, which are useful, & I have no doubt you have been made acquainted with them. trigonometry, so far as this, is most valuable to every man, there is scarcely a day in which he will not resort to it for some of the purposes of common life. the science of calculation also is indispensable as far as the extraction of the square & cube roots; Algebra as far as the quadratic equation & the use of logarithms are often of value in ordinary cases: but all beyond these is but a luxury; a delicious luxury indeed; but not to be indulged in by one who is to have a profession to follow for his subsistence. in this light I view the conic sections, curves of the higher orders, perhaps even spherical trigonometry, Algebraical operations beyond the 2d dimension, and fluxions.*

Letter from Thomas Jefferson to William G. Munford, Monticello, June 18, 1799.

1. A fair coin is thrown in the air four times. If the coin lands with the head up on the first three tosses, what is the probability that the coin will land with the head up on the fourth toss?

[A]  $\frac{1}{2}$     [B]  $\frac{1}{8}$     [C] 0    [D]  $\frac{1}{16}$

2. The statement "If  $x$  is divisible by 8, then it is divisible by 6" is false if  $x$  equals

[A] 48    [B] 32    [C] 6    [D] 14

3. What is the image of point (2,5) under the translation that shifts  $(x,y)$  to  $(x+3, y-2)$ ?

[A] (5,3)    [B] (0,8)    [C] (0,3)    [D] (5,8)

4. The sum of  $3x^2 + x + 8$  and  $x^2 - 9$  can be expressed as

[A]  $4x^2 + x - 17$     [B]  $4x^2 + x - 1$   
[C]  $4x^4 + x - 1$     [D]  $3x^4 + x - 1$

5. The direct distance between city A and city B is 200 miles. The direct distance between city B and city C is 300 miles. Which could be the direct distance between city C and city A?

[A] 50 miles    [B] 350 miles  
[C] 650 miles    [D] 550 miles

6. Expressed as a single fraction, what is  $\frac{1}{x+1} + \frac{1}{x}$ ,  $x \neq 0, -1$ ?

[A]  $\frac{2x+3}{x^2+x}$     [B]  $\frac{3}{x^2}$   
[C]  $\frac{2}{2x+1}$     [D]  $\frac{2x+1}{x^2+x}$

7. How many different three-member teams can be formed from six students?

[A] 216    [B] 720    [C] 20    [D] 120

8. If  $x = -3$  and  $y = 2$ , which point on the accompanying graph represents  $(-x, -y)$ ?

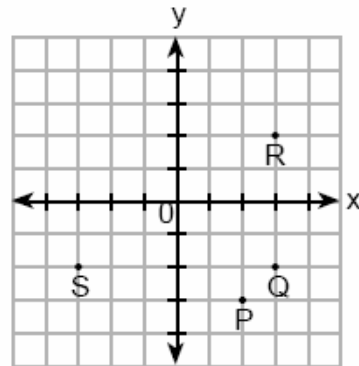

[A] S    [B] P    [C] Q    [D] R

9. The larger root of the equation  $(x+4)(x-3) = 0$  is

[A] -4    [B] -3    [C] 3    [D] 4

10. Linda paid \$48 for a jacket that was on sale for 25% of the original price. What was the original price of the jacket?

[A] \$60 [B] \$192 [C] \$72 [D] \$96

11. The expression  $2^3 \cdot 4^2$  is equivalent to

[A]  $2^7$  [B]  $2^{12}$  [C]  $8^6$  [D]  $8^5$

12. In the accompanying diagram of  $\triangle ABC$ ,  $\overline{AB}$  is extended to  $D$ , exterior angle  $CBD$  measures  $145^\circ$ , and  $m\angle C = 75^\circ$ .

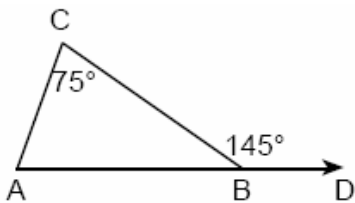

What is  $m\angle CAB$ ?

[A] 70 [B] 110 [C] 220 [D] 35

13. A total of \$450 is divided into equal shares. If Kate receives four shares, Kevin receives three shares, and Anna receives the remaining two shares, how much money did Kevin receive?

[A] \$200 [B] \$250  
[C] \$100 [D] \$150

14. What is the diameter of a circle whose circumference is 5?

[A]  $\frac{5}{\pi^2}$  [B]  $\frac{2.5}{\pi^2}$  [C]  $\frac{5}{\pi}$  [D]  $\frac{2.5}{\pi}$

15. During a recent winter, the ratio of deer to foxes was 7 to 3 in one county of New York State. If there were 210 foxes in the county, what was the number of deer in the county?

[A] 147 [B] 490 [C] 90 [D] 280

16. In the accompanying figure,  $ACDH$  and  $BCEF$  are rectangles,  $AH = 2$ ,  $GH = 3$ ,  $GF = 4$ , and  $FE = 5$ .

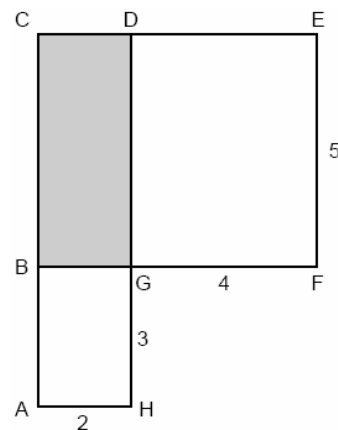

What is the area of  $BCDG$ ?

[A] 10 [B] 8 [C] 20 [D] 6

17. If  $t^2 < t < \sqrt{t}$ , then  $t$  could be

[A]  $-\frac{1}{4}$  [B] 4 [C] 0 [D]  $\frac{1}{4}$

18. What is the slope of line  $\ell$  shown in the accompanying diagram?

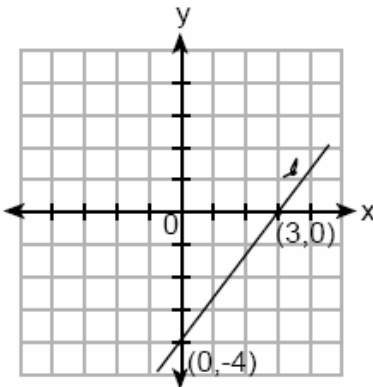

- [A]  $-\frac{3}{4}$    [B]  $-\frac{4}{3}$    [C]  $\frac{4}{3}$    [D]  $\frac{3}{4}$

19. In a class of 50 students, 18 take music, 26 take art, and 2 take both art and music. How many students in the class are not enrolled in either music or art?

- [A] 24   [B] 6   [C] 16   [D] 8

20. The expression  $\sqrt{27} + \sqrt{12}$  is equivalent to

- [A]  $13\sqrt{3}$    [B]  $\sqrt{39}$   
[C]  $5\sqrt{3}$    [D]  $5\sqrt{6}$

21. Draw all the symmetry lines on the accompanying figure.

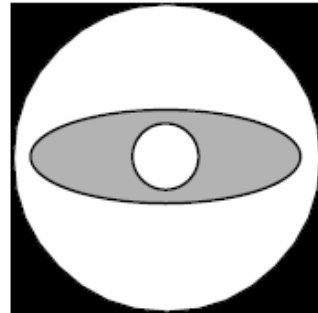

22. Shoe sizes and foot length are related by the formula  $S = 3F - 24$ , where  $S$  represents the shoe size and  $F$  represents the length of the foot, in inches.

a Solve the formula for  $F$ .

b To the *nearest tenth of an inch*, how long is the foot of a person who wears a size  $10\frac{1}{2}$  shoe?

23. Which number below is irrational?

$$\sqrt{\frac{4}{9}}, \sqrt{20}, \sqrt{121}$$

Why is the number you chose an irrational number?

24. Simplify:  $\frac{9x^2 - 15xy}{9x^2 - 25y^2}$

25. Sara's telephone service costs \$21 per month plus \$0.25 for each local call, and long-distance calls are extra. Last month, Sara's bill was \$36.64, and it included \$6.14 in long-distance charges. How many local calls did she make?
26. During a 45-minute lunch period, Albert (A) went running and Bill (B) walked for exercise. Their times and distances are shown in the accompanying graph. How much faster was Albert running than Bill was walking, in miles per hour?

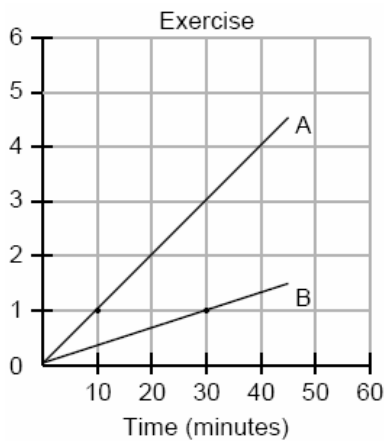

27. The dimensions of a brick, in inches, are 2 by 4 by 8. How many such bricks are needed to have a total volume of exactly 1 cubic foot?
28. A swimmer plans to swim at least 100 laps during a 6-day period. During this period, the swimmer will increase the number of laps completed each day by one lap. What is the *least* number of laps the swimmer must complete on the first day?

29. The mean (average) weight of three dogs is 38 pounds. One of the dogs, Sparky, weighs 46 pounds. The other two dogs, Eddie and Sandy, have the same weight. Find Eddie's weight.
30. In the accompanying diagram,  $\triangle ABC$  and  $\triangle ABD$  are isosceles triangles with  $m\angle CAB = 50$  and  $m\angle BDA = 55$ . If  $AB=AC$  and  $AB=BD$ , what is  $m\angle CBD$ ?

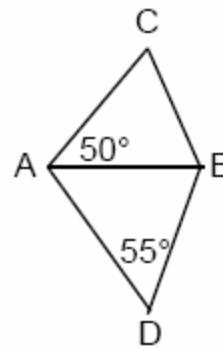

31. A target shown in the accompanying diagram consists of three circles with the same center. The radii of the circles have lengths of 3 inches, 7 inches, and 9 inches.

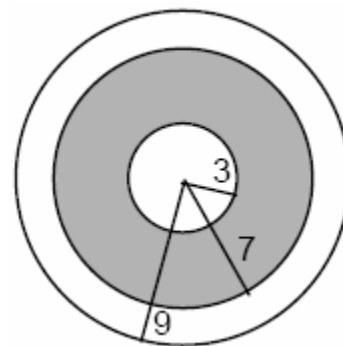

- a What is the area of the shaded region to the nearest tenth of a square inch?
- b To the nearest percent, what percent of the target is shaded?

32. A bookshelf contains six mysteries and three biographies. Two books are selected at random without replacement.
- a What is the probability that both books are mysteries?
- b What is the probability that one book is a mystery and the other is a biography?

35. Solve the following system of equations algebraically or graphically for  $x$  and  $y$ :

$$y = x^2 + 2x - 1$$

$$y = 3x + 5$$

For an algebraic solution, show your work here .

For a graphic solution, show your work here.

33. The cross section of an attic is in the shape of an isosceles trapezoid, as shown in the accompanying figure. If the height of the attic is 9 feet,  $BC = 12$  feet, and  $AD = 28$  feet, find the length of  $\overline{AB}$  to the *nearest foot*.

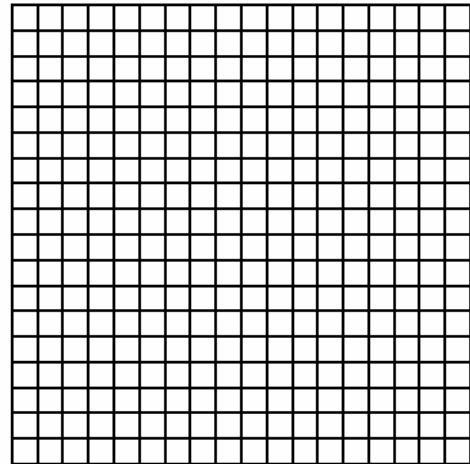
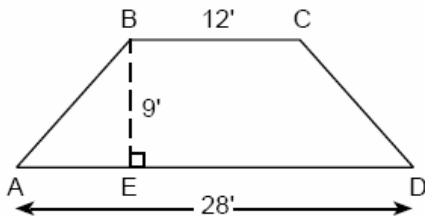

34. Joe is holding his kite string 3 feet above the ground, as shown in the accompanying diagram. The distance between his hand and a point directly under the kite is 95 feet. If the angle of elevation to the kite is  $50^\circ$ , find the height,  $h$ , of his kite, to the *nearest foot*.

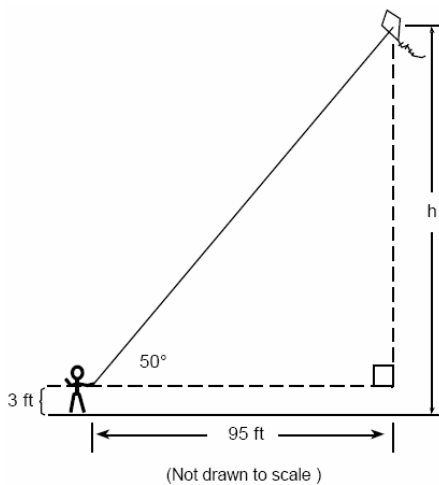

1. A roll of candy is shown in the accompanying diagram.



The shape of the candy is best described as a

- [A] cone [B] cylinder  
[C] pyramid [D] rectangular solid
2. The expression  $\sqrt{50}$  can be simplified to
- [A]  $2\sqrt{25}$  [B]  $5\sqrt{10}$   
[C]  $5\sqrt{2}$  [D]  $25\sqrt{2}$
3. The transformation of  $\triangle ABC$  to  $\triangle AB'C'$  is shown in the accompanying diagram.

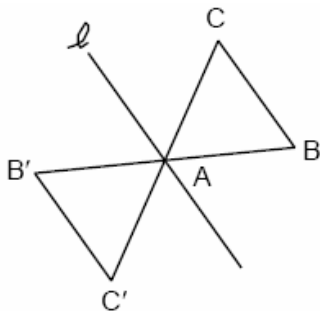

This transformation is an example of a

- [A] rotation about point A  
[B] line reflection in point  $\ell$   
[C] dilation [D] translation

4. Which expression is equivalent to  $6.02 \times 10^{23}$ ?
- [A]  $6020 \times 10^{21}$  [B]  $60.2 \times 10^{21}$   
[C]  $0.602 \times 10^{21}$  [D]  $602 \times 10^{21}$
5. The Pentagon building in Washington, D.C., is shaped like a regular pentagon. If the length of one side of the Pentagon is represented by  $n + 2$ , its perimeter would be represented by
- [A]  $5n + 2$  [B]  $n + 10$   
[C]  $5n + 10$  [D]  $10n$
6. The product of  $4x^2y$  and  $2xy^3$  is
- [A]  $8x^3y^4$  [B]  $8x^2y^4$   
[C]  $8x^2y^3$  [D]  $8x^3y^3$
7. Which equation is an illustration of the additive identity property?
- [A]  $x \cdot 1 = x$  [B]  $x \cdot \frac{1}{x} = 1$   
[C]  $x - x = 0$  [D]  $x + 0 = x$
8. The formula  $C = \frac{5}{9}(F - 32)$  can be used to find the Celsius temperature ( $C$ ) for a given Fahrenheit temperature ( $F$ ). What Celsius temperature is equal to a Fahrenheit temperature of  $77^\circ$ ?
- [A]  $45^\circ$  [B]  $25^\circ$  [C]  $8^\circ$  [D]  $171^\circ$

9. In the accompanying diagram of rectangle ABCD,  $m\angle BAC = 3x + 4$  and  $m\angle ACD = x + 28$ .

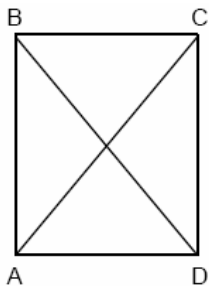

What is  $m\angle CAD$ ?

- [A] 50    [B] 40    [C] 37    [D] 12

10. On June 17, the temperature in New York City ranged from  $90^\circ$  to  $99^\circ$ , while the temperature in Niagara Falls ranged from  $60^\circ$  to  $69^\circ$ . The difference in the temperatures in these two cities must be between

- [A]  $20^\circ$  and  $30^\circ$     [B]  $20^\circ$  and  $40^\circ$   
[C]  $30^\circ$  and  $40^\circ$     [D]  $25^\circ$  and  $35^\circ$

11. Which expression is equivalent to  $\frac{a}{x} + \frac{b}{2x}$ ?

- [A]  $\frac{a+b}{2x}$     [B]  $\frac{2a+b}{x}$   
[C]  $\frac{a+b}{3x}$     [D]  $\frac{2a+b}{2x}$

12. What is true about the statement "If two angles are right angles, the angles have equal measure" and its converse "If two angles have equal measure then the two angles are right angles"?

- [A] The statement is true but its converse is false.  
[B] Both the statement and its converse are false.  
[C] Both the statement and its converse are true.  
[D] The statement is false but its converse is true.

13. If 6 and  $x$  have the same mean (average) as 2, 4, and 24, what is the value of  $x$ ?

- [A] 5    [B] 10    [C] 14    [D] 36

14. In a hockey league, 87 players play on seven different teams. Each team has at least 12 players. What is the largest possible number of players on any one team?

- [A] 15    [B] 21    [C] 14    [D] 13



15. In the accompanying diagram of equilateral triangle  $ABC$ ,  $DE = 5$  and  $\overline{DE} \parallel \overline{AB}$ .

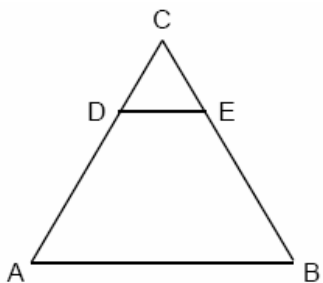

If  $AB$  is three times as long as  $DE$ , what is the perimeter of quadrilateral  $ABED$ ?

- [A] 30    [B] 20    [C] 40    [D] 35
16. At a concert, \$720 was collected for hot dogs, hamburgers, and soft drinks. All three items sold for \$1.00 each. Twice as many hot dogs were sold as hamburgers. Three times as many soft drinks were sold as hamburgers. The number of soft drinks sold was
- [A] 120    [B] 480    [C] 240    [D] 360
17. How many different 6-letter arrangements can be formed using the letters in the word “**ABSENT**,” if each letter is used only once?
- [A] 6    [B] 36    [C] 46,656    [D] 720
18. The ratio of the corresponding sides of two similar squares is 1 to 3. What is the ratio of the area of the smaller square to the area of the larger square ?
- [A]  $1:\sqrt{3}$     [B] 1:3    [C] 1:9    [D] 1:6
19. What is the slope of the line whose equation is  $3x - 4y - 16 = 0$ ?
- [A]  $\frac{3}{4}$     [B] -4    [C]  $\frac{4}{3}$     [D] 3
20. What is the perimeter of an equilateral triangle whose height is  $2\sqrt{3}$  ?
- [A]  $6\sqrt{3}$     [B] 12    [C] 6    [D]  $12\sqrt{3}$
21. Solve for  $x$ :  $2(x - 3) = 1.2 - x$
22. The Grimaldis have three children born in different years.
- a* Draw a tree diagram or list a sample space to show all the possible arrangements of boy and girl children in the Grimaldi family.
- b* Using your information from part *a*, what is the probability that the Grimaldis have three boys?
23. Paloma has 3 jackets, 6 scarves, and 4 hats. Determine the number of different outfits consisting of a jacket, a scarf, and a hat that Paloma can wear.

24. In a recent poll, 600 people were asked whether they liked Chinese food. A circle graph was constructed to show the results. The central angles for two of the three sectors are shown in the accompanying diagram. How many people had no opinion?

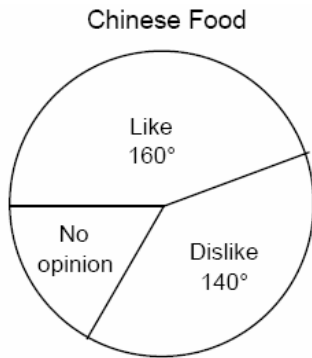

25. Maria's backyard has two trees that are 40 feet apart, as shown in the accompanying diagram. She wants to place lampposts so that the posts are 30 feet from both of the trees. Draw a sketch to show where the lampposts could be placed in relation to the trees. How many locations for the lampposts are possible?

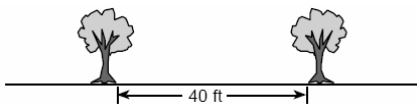

26. Solve for  $x$ :  $x^2 + 3x - 40 = 0$

27. A person standing on level ground is 2,000 feet away from the foot of a 420-foot-tall building, as shown in the accompanying diagram. To the *nearest degree*, what is the value of  $x$ ?

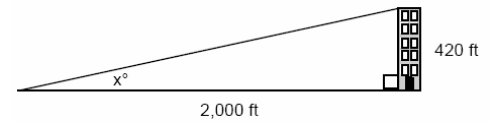

28. Bob and Ray are describing the same number. Bob says, "The number is a positive even integer less than or equal to 20." Ray says, "The number is divisible by 4." If Bob's statement is true and Ray's statement is false, what are all the possible numbers?

29. Line  $\ell$  contains the points  $(0,4)$  and  $(2,0)$ . Show that the point  $(-25,81)$  does or does not lie on line  $\ell$ .
30. A painting that regularly sells for a price of \$55 is on sale for 20% off. The sales tax on the painting is 7%. Will the final total cost of the painting differ depending on whether the salesperson deducts the discount before adding the sales tax or takes the discount after computing the sum of the original price and the sales tax on \$55?

31. The profits in a business are to be shared by the three partners in the ratio of 3 to 2 to 5. The profit for the year was \$176,500. Determine the number of dollars each partner is to receive.

32. If asphalt pavement costs \$0.78 per square foot, determine, to the *nearest cent*, the cost of paving the shaded circular road with center O, an outside radius of 50 feet, and an inner radius of 36 feet, as shown in the accompanying diagram.

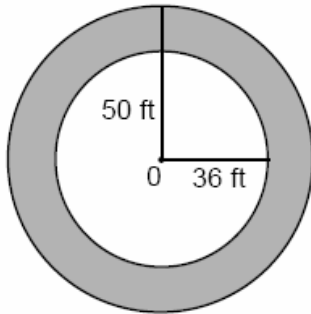

33. An arch is built so that it is 6 feet wide at the base. Its shape can be represented by a parabola with the equation  $y = -2x^2 + 12x$ , where  $y$  is the height of the arch.  
a Graph the parabola from  $x = 0$  to  $x = 6$  on the grid below.

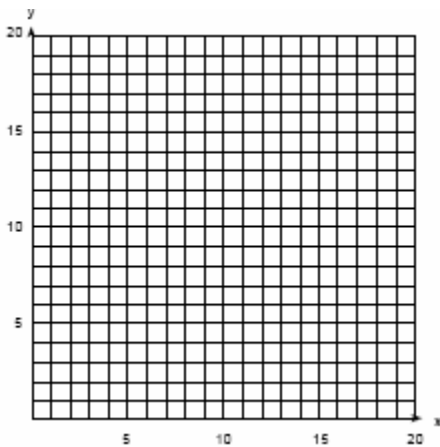

- b Determine the maximum height,  $y$ , of the arch.

34. Mr. Gonzalez owns a triangular plot of land  $BCD$  with  $DB = 25$  yards and  $BC = 16$  yards. He wishes to purchase the adjacent plot of land in the shape of right triangle  $ABD$ , as shown in the accompanying diagram, with  $AD = 15$  yards. If the purchase is made, what will be the total number of square yards in the area of his plot of land,  $\triangle ACD$ ?

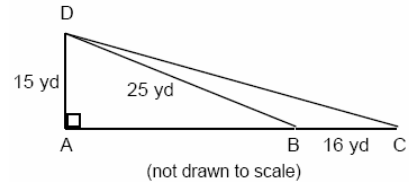

35. Two health clubs offer different membership plans. The graph below represents the total cost of belonging to Club A and Club B for one year.

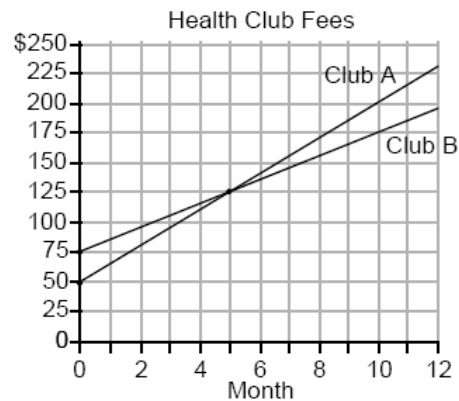

- a If the yearly cost includes a membership fee plus a monthly charge, what is the membership fee for Club A?  
b (1) What is the number of the month when the total cost is the same for both clubs?  
(2) What is the total cost for Club A when both plans are the same?  
c What is the monthly charge for Club B?

- The expression  $\sqrt{93}$  is a number between  
 [A] 46 and 47      [B] 9 and 10  
 [C] 3 and 9      [D] 8 and 9
- Which number has the greatest value?  
 [A] 1.5    [B]  $\frac{\pi}{2}$     [C]  $\sqrt{2}$     [D]  $1\frac{2}{3}$
- Mary says, "The number I am thinking of is divisible by 2 or it is divisible by 3." Mary's statement is false if the number she is thinking of is  
 [A] 8      [B] 6      [C] 11      [D] 15
- Which expression is a factor of  $x^2 + 2x - 15$   
 [A]  $(x - 5)$       [B]  $(x + 15)$   
 [C]  $(x + 3)$       [D]  $(x - 3)$
- What was the median high temperature in Middletown during the 7-day period shown in the table below?

Daily High Temperature in Middletown	
Day	Temperature (°F)
Sunday	68
Monday	73
Tuesday	73
Wednesday	75
Thursday	69
Friday	67
Saturday	63

- [A] 70    [B] 69    [C] 75    [D] 73

- If the number represented by  $n-3$  is an odd integer, which expression represents the next greater odd integer?  
 [A]  $n + 1$       [B]  $n - 1$   
 [C]  $n - 2$       [D]  $n - 5$
- When the point  $(2, -5)$  is reflected in the  $x$ -axis, what are the coordinates of its image?  
 [A]  $(5, 2)$       [B]  $(-5, 2)$   
 [C]  $(2, 5)$       [D]  $(-2, 5)$
- The expression  $(x^2z^3)(xy^2z)$  is equivalent to  
 [A]  $x^3y^2z^4$       [B]  $x^4y^2z^5$   
 [C]  $x^3y^3z^4$       [D]  $x^2y^2z^3$
- Twenty-five percent of 88 is the same as what percent of 22?  
 [A]  $12\frac{1}{2}\%$       [B] 40%  
 [C] 100%      [D] 50%

10. A plot of land is in the shape of rhombus  $ABCD$  as shown below.

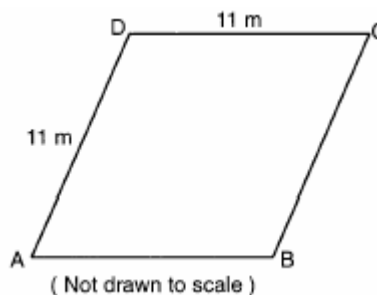

Which can *not* be the length of diagonal  $AC$ ?

- [A] 4 m      [B] 11 m  
 [C] 24 m      [D] 18 m

11. If  $9x + 2a = 3a - 4x$ , then  $x$  equals  
 [A]  $-a$  [B]  $\frac{5a}{12}$  [C]  $\frac{a}{13}$  [D]  $a$
12. If the circumference of a circle is  $10\pi$  inches, what is the area, in square inches, of the circle?  
 [A]  $50\pi$  [B]  $100\pi$   
 [C]  $10\pi$  [D]  $25\pi$
13. How many different 4-letter arrangements can be formed using the letters of the word "JUMP," if each letter is used only once?  
 [A] 12 [B] 16 [C] 24 [D] 4
14. Sterling silver is made of an alloy of silver and copper in the ratio of 37:3. If the mass of a sterling silver ingot is 600 grams, how much silver does it contain?  
 [A] 555 g [B] 450 g  
 [C] 200 g [D] 48.65 g
15. If  $t = -3$ , then  $3t^2 + 5t + 6$  equals  
 [A] -36 [B] -6 [C] 6 [D] 18
16. The expression  $\frac{y}{x} - \frac{1}{2}$  is equivalent to  
 [A]  $\frac{2y-x}{2x}$  [B]  $\frac{1-y}{2x}$   
 [C]  $\frac{y-1}{x-2}$  [D]  $\frac{x-2y}{2x}$

17. The party registration of the voters in Jonesville is shown in the table below.

Registered Voters in Jonesville	
Party Registration	Number of Voters Registered
Democrat	6,000
Republican	5,300
Independent	3,700

If one of the registered Jonesville voters is selected at random, what is the probability that the person selected is *not* a Democrat?

- [A] 0.600 [B] 0.333  
 [C] 0.667 [D] 0.400
18. If the number of molecules in 1 mole of a substance is  $6.02 \times 10^{23}$ , then the number of molecules in 100 moles is  
 [A]  $6.02 \times 10^{24}$  [B]  $6.02 \times 10^{21}$   
 [C]  $6.02 \times 10^{22}$  [D]  $6.02 \times 10^{25}$
19. When  $3a^2 - 2a + 5$  is subtracted from  $a^2 + a - 1$ , the result is  
 [A]  $-2a^2 + 3a - 6$  [B]  $2a^2 - 3a - 6$   
 [C]  $-2a^2 + 3a + 6$  [D]  $2a^2 - 3a + 6$
20. The distance between parallel lines  $\ell$  and  $m$  is 12 units. Point  $A$  is on line  $\ell$ . How many points are equidistant from lines  $\ell$  and  $m$  and 8 units from point  $A$ .  
 [A] 2 [B] 3 [C] 4 [D] 1

21. The midpoint  $M$  of line segment  $AB$  has coordinates  $(-3,4)$ . If point  $A$  is the origin,  $(0,0)$ , what are the coordinates of point  $B$ ? [The use of the accompanying grid is optional.]

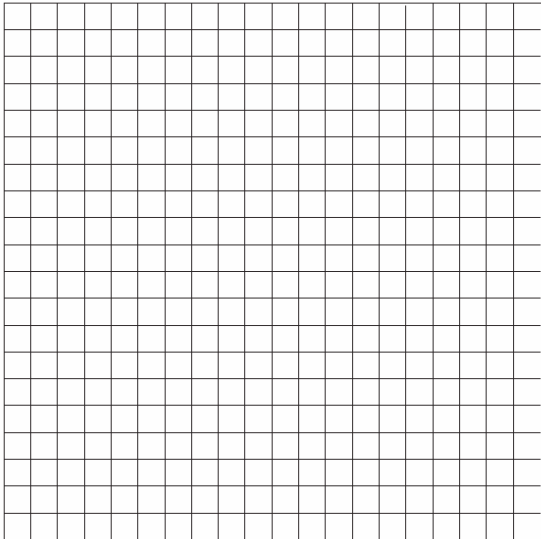

24. A straight line with slope 5 contains the points  $(1,2)$  and  $(3,K)$ . Find the value of  $K$ . [The use of the accompanying grid is optional.]

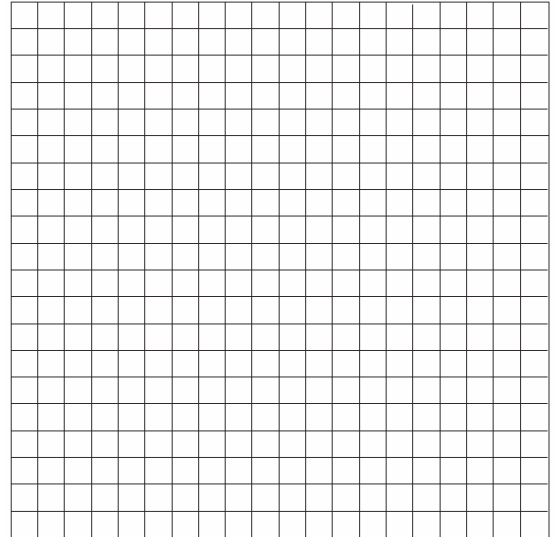

22. Mary and Amy had a total of 20 yards of material from which to make costumes. Mary used three times more material to make her costume than Amy used, and 2 yards of material was not used. How many yards of materials did Amy use for her costume?

23. A wall is supported by a brace 10 feet long, as shown in the diagram below. If one end of the brace is placed 6 feet from the base of the wall, how many feet up the wall does the brace reach?

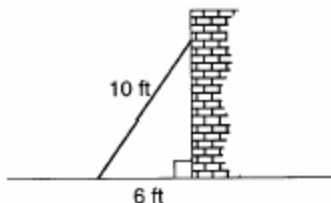

25. Al says, "If  $ABCD$  is a parallelogram, then  $ABCD$  is a rectangle." Sketch a quadrilateral  $ABCD$  that shows that Al's statement is not always true. Your sketch must show the length of each side and the measure of each angle for the quadrilateral you draw.

26. Judy needs a mean (average) score of 86 on four tests to earn a midterm grade of B. If the mean of her scores for the first three tests was 83, what is the *lowest* score on a 100-point scale that she can receive on the fourth test to have a midterm grade of B?

27. A truck traveling at a constant rate of 45 miles per hour leaves Albany. One hour later a car traveling at a constant rate of 60 miles per hour also leaves Albany traveling in the same direction on the same highway. How long will it take for the car to catch up to the truck, if both vehicles continue in the same direction on the highway?

28. In the figure below, the large rectangle,  $ABCD$ , is divided into four smaller rectangles. The area of rectangle  $AEHG = 5x$ , the area of rectangle  $GHFB = 2x^2$ , the area of rectangle  $HJCF = 6x$ , segment  $AG = 5$ , and segment  $AE = x$ .

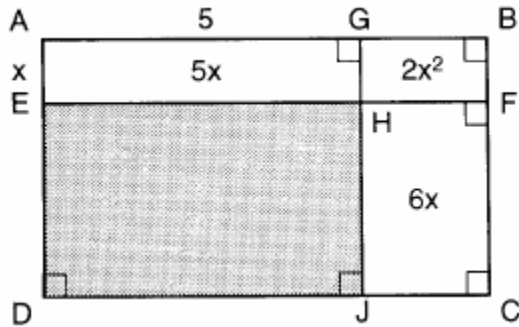

- a Find the area of the shaded region.  
b Write an expression for the area of the rectangle  $ABCD$  in terms of  $x$ .

29. a On the set of axes provided below, sketch a circle with a radius of 3 and center at  $(2,1)$  and also sketch the graph of the line  $2x + y = 8$ .

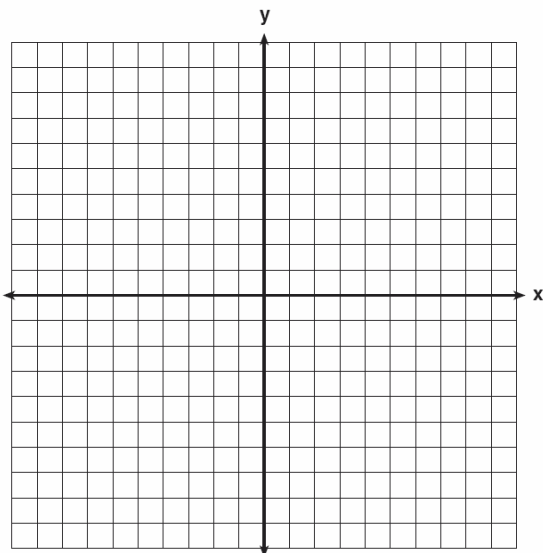

- b What is the total number of points of intersection of the two graphs?

30. The volume of a rectangular pool is 1,080 cubic meters. Its length, width, and depth are in the ratio 10:4:1. Find the number of meters in each of the three dimensions of the pool.

31. Amy tossed a ball in the air in such a way that the path of the ball was modeled by the equation  $y = -x^2 + 6x$ . In the equation,  $y$  represents the height of the ball in feet and  $x$  is the time in seconds.

a Graph  $y = -x^2 + 6x$  for  $0 \leq x \leq 6$  on the grid provided below.

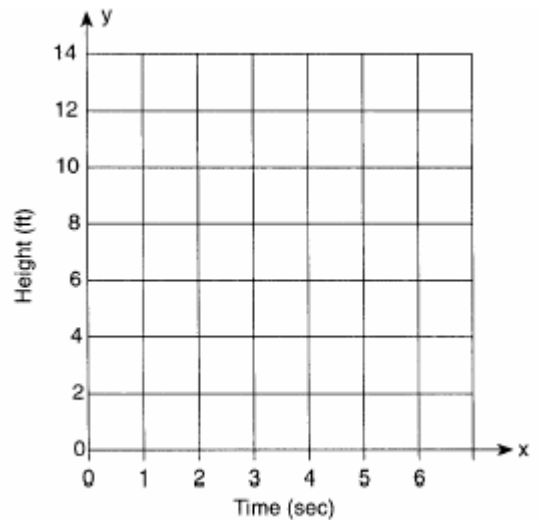

- b At what time,  $x$ , is the ball at its highest point?

32. In the time trials for the 400-meter run at the state sectionals, the 15 runners recorded the times shown in the table below.

400-Meter Run	
Time (sec)	Frequency
50.0–50.9	
51.0–51.9	II
52.0–52.9	IIII
53.0–53.9	III
54.0–54.9	IIII

- a Using the data from the frequency column, draw a frequency histogram on the grid provided below.

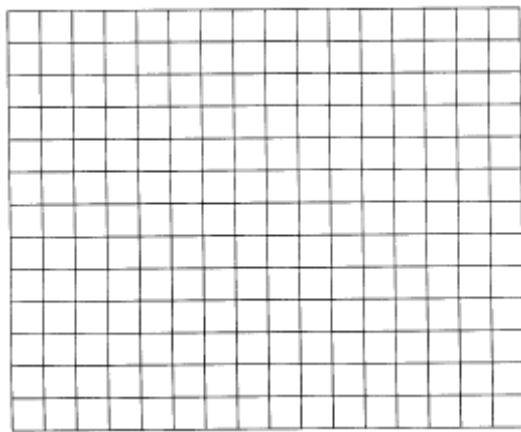

- b What percent of the runners completed the time trial between 52.0 and 53.9 seconds?
33. A group of 148 people is spending five days at a summer camp. The cook ordered 12 pounds of food for each adult and 9 pounds of food for each child. A total of 1,410 pounds of food was ordered.
- a Write an equation or a system of equations that describes the above situation and define your variables.
- b Using your work from part a, find:
- (1) the total number of adults in the group
  - (2) the total number of children in the group

34. Three roses will be selected for a flower vase. The florist has 1 red rose, 1 white rose, 1 yellow rose, 1 orange rose and 1 pink rose from which to choose.
- a How many different three rose selections can be formed from the 5 roses?
- b What is the probability that 3 roses selected at random will contain 1 red rose, 1 white rose, and 1 pink rose?
- c What is the probability that 3 roses selected at random will *not* contain an orange rose?

35. The Excel Cable Company has a monthly fee of \$32.00 and an additional charge of \$8.00 for each premium channel. The Best Cable Company has a monthly fee of \$26.00 and additional charge of \$10.00 for each premium channel. The Horton family is deciding which of these two cable companies to subscribe to.
- a For what number of premium channels will the total monthly subscription fee for the Excel and Best Cable companies be the same?
- b The Horton family decides to subscribe to 2 premium channels for a period of one year.
- (1) Which cable company should they subscribe to in order to spend less money?
  - (2) How much money will the Hortons save in one year by using the less expensive company?







1. Which inequality is represented in the graph below?



- [A]  $-4 \leq x < 2$       [B]  $-4 < x < 2$   
[C]  $-4 < x \leq 2$       [D]  $-4 \leq x \leq 2$

2. Which geometric figure has one and only one line of symmetry?

[A]  Rhombus	[B]  Square
[C]  Isosceles trapezoid	[D]  Rectangle

3. Which number is rational?

- [A]  $\sqrt{7}$     [B]  $\frac{5}{4}$     [C]  $\sqrt{\frac{3}{2}}$     [D]  $\pi$

4. Two numbers are in the ratio 2:5. If 6 is subtracted from their sum, the result is 50. What is the larger number?

- [A] 35    [B] 40    [C] 55    [D] 45

5. The quotient of  $-\frac{15x^8}{5x^2}$ ,  $x \neq 0$ , is

- [A]  $-10x^6$       [B]  $-10x^4$   
[C]  $-3x^4$       [D]  $-3x^6$

6. What is the inverse of the statement "If it is sunny, I will play baseball"?

- [A] If I do not play baseball, then it is not sunny.  
[B] If I play baseball, then it is sunny.  
[C] I will play baseball if and only if it is sunny.  
[D] If it is not sunny, I will not play baseball.

7. Which ordered pair is the solution of the following system of equations?

$$\begin{aligned} 3x + 2y &= 4 \\ -2x + 2y &= 24 \end{aligned}$$

- [A] (-4,8)      [B] (2,-1)  
[C] (-4,-8)      [D] (2,-5)

8. Which equation represents a circle whose center is (3, -2)?

- [A]  $(x - 2)^2 + (y + 3)^2 = 4$   
[B]  $(x + 3)^2 + (y - 2)^2 = 4$   
[C]  $(x + 2)^2 + (y - 3)^2 = 4$   
[D]  $(x - 3)^2 + (y + 2)^2 = 4$

9. The set of integers {3,4,5} is a Pythagorean triple. Another such set is

- [A] {8,15,17}      [B] {6,8,12}  
[C] {6,7,8}      [D] {6,12,13}

10. A truck travels 40 miles from point  $A$  to point  $B$  in exactly 1 hour. When the truck is halfway between point  $A$  and point  $B$ , a car starts from point  $A$  and travels at 50 miles per hour. How many miles has the car traveled when the truck reaches point  $B$ ?
- [A] 25    [B] 60    [C] 40    [D] 50

11. If  $a \neq 0$  and the sum of  $x$  and  $\frac{1}{a}$  is 0, then
- [A]  $x = -a$                       [B]  $x = 1 - a$   
[C]  $x = a$                         [D]  $x = -\frac{1}{a}$

12. The accompanying figure shows the graph of the equation  $x = 5$ .

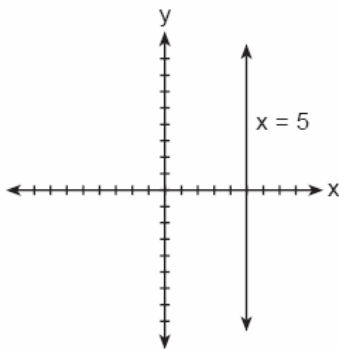

- What is the slope of the line  $x = 5$ ?
- [A] 5    [B] -5    [C] 0    [D] undefined

13. Which transformation does *not* always produce an image that is congruent to the original figure?
- [A] translation                      [B] dilation  
[C] rotation                          [D] reflection

14. If rain is falling at the rate of 2 inches per hour, how many inches of rain will fall in  $x$  minutes?
- [A]  $\frac{60}{x}$     [B]  $\frac{30}{x}$     [C]  $2x$     [D]  $\frac{x}{30}$

15. The expression  $(x - 6)^2$  is equivalent to
- [A]  $x^2 + 36$                       [B]  $x^2 - 36$   
[C]  $x^2 + 12x + 36$             [D]  $x^2 - 12x + 36$

16. How many different five-digit numbers can be formed from the digits 1, 2, 3, 4, and 5 if each digit is used only once?
- [A] 120    [B] 60    [C] 20    [D] 24

17. For five algebra examinations, Maria has an average of 88. What must she score on the sixth test to bring her average up to exactly 90?
- [A] 98    [B] 92    [C] 100    [D] 94

18. The graphs of the equations  $y = x^2 + 4x - 1$  and  $y + 3 = x$  are drawn on the same set of axes. At which point do the graphs intersect?
- [A] (1, 4)                              [B] (-2, 1)  
[C] (-2, -5)                          [D] (1, -2)

19. If  $2x^2 - 4x + 6$  is subtracted from  $5x^2 + 8x - 2$ , the difference is
- [A]  $-3x^2 - 12x + 8$             [B]  $-3x^2 + 4x + 4$   
[C]  $3x^2 + 12x - 8$               [D]  $3x^2 + 4x + 4$

20. What is the value of  $3^{-2}$ ?

- [A]  $-\frac{1}{9}$     [B] -9    [C] 9    [D]  $\frac{1}{9}$

21. The formula for changing Celsius (C) temperature to Fahrenheit (F) temperature is

$$F = \frac{9}{5}C + 32.$$

Calculate, to the *nearest degree*, the Fahrenheit temperature when the Celsius temperature is -8.

22. Using only a ruler and compass, construct the bisector of angle  $BAC$  in the accompanying diagram.

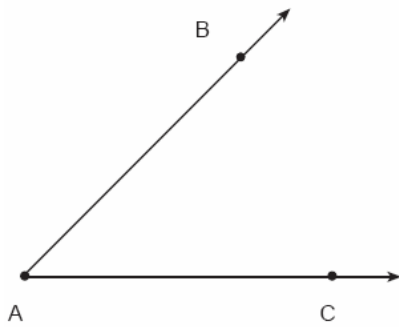

23. All seven-digit telephone numbers in a town begin with 245. How many telephone numbers may be assigned in the town if the last four digits do *not* begin or end in a zero?

24. The Rivera family bought a new tent for camping. Their old tent had equal sides of 10 feet and a floor width of 15 feet, as shown in the accompanying diagram.

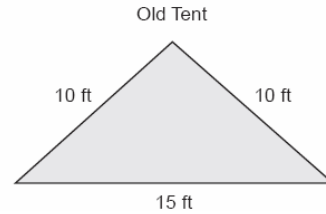

If the new tent is similar in shape to the old tent and has equal sides of 16 feet, how wide is the floor of the new tent?

25. The accompanying graph represents the yearly cost of playing 0 to 5 games of golf at the Shadybrook Golf Course. What is the total cost of joining the club and playing 10 games during the year?

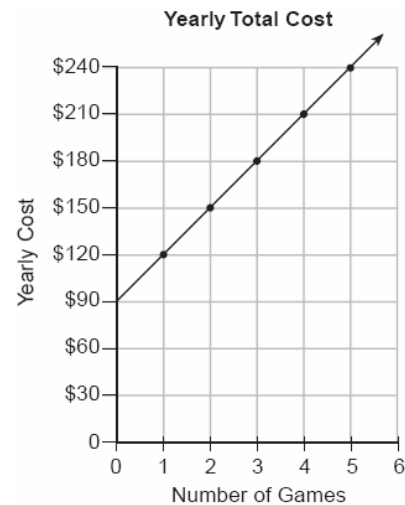

26. The accompanying Venn diagram shows the number of students who take various courses. All students in circle A take mathematics. All in circle B take science. All in circle C take technology. What percentage of the students take mathematics or technology?

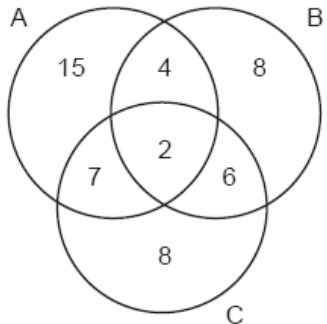

27. Hersch says if a triangle is an obtuse triangle, then it cannot also be an isosceles triangle. Using a diagram, show that Hersch is incorrect, and indicate the measures of all the angles and sides to justify your answer.
28. Tamika has a hard rubber ball whose circumference measures 13 inches. She wants to box it for a gift but can only find cube-shaped boxes of sides 3 inches, 4 inches, 5 inches, or 6 inches. What is the *smallest* box that the ball will fit into with the top on?
29. The distance from Earth to the imaginary planet Med is  $1.7 \times 10^7$  miles. If a spaceship is capable of traveling 1,420 miles per hour, how many days will it take the spaceship to reach the planet Med? Round your answer to the *nearest day*.

30. A surveyor needs to determine the distance across the pond shown in the accompanying diagram. She determines that the distance from her position to point  $P$  on the south shore of the pond is 175 meters and the angle from her position to point  $X$  on the north shore is  $32^\circ$ . Determine the distance,  $PX$ , across the pond, rounded to the *nearest meter*.

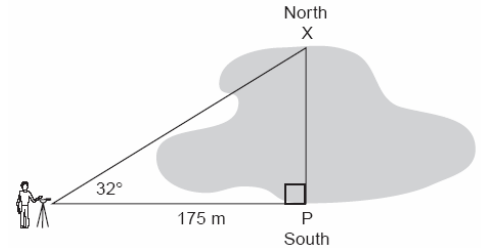

31. The owner of a movie theater was counting the money from 1 day's ticket sales. He knew that a total of 150 tickets were sold. Adult tickets cost \$7.50 each and children's tickets cost \$4.75 each. If the total receipts for the day were \$891.25, how many of *each* kind of ticket were sold?
32. A treasure map shows a treasure hidden in a park near a tree and a statue. The map indicates that the tree and the statue are 10 feet apart. The treasure is buried 7 feet from the base of the tree and also 5 feet from the base of the statue. How many places are possible locations for the treasure to be buried? Draw a diagram of the treasure map, and indicate with an **X** *each* possible location of the treasure.

33. The scores on a mathematics test were 70, 55, 61, 80, 85, 72, 65, 40, 74, 68, and 84.

Complete the accompanying table, and use the table to construct a frequency histogram for these scores.

Score	Tally	Frequency
40–49		
50–59		
60–69		
70–79		
80–89		

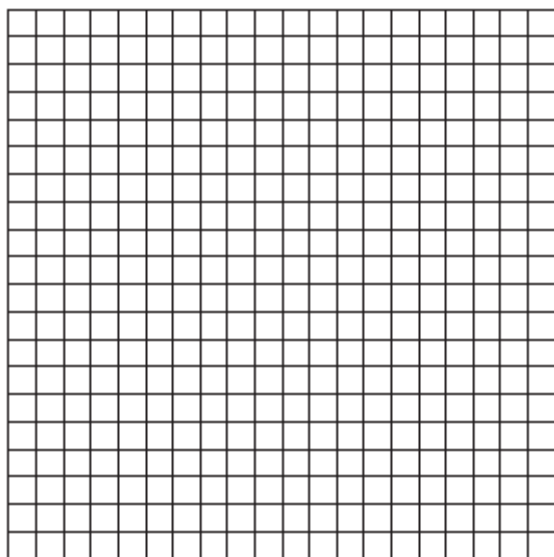

35. The area of the rectangular playground enclosure at South School is 500 square meters. The length of the playground is 5 meters longer than the width. Find the dimensions of the playground, in meters. [Only an algebraic solution will be accepted.]

34. Paul orders a pizza. Chef Carl randomly chooses two different toppings to put on the pizza from the following: pepperoni, onion, sausage, mushrooms, and anchovies. If Paul will not eat pizza with mushrooms, determine the probability that Paul will *not* eat the pizza Chef Carl has made.

1. The product of  $2x^3$  and  $6x^5$  is  
[A]  $10x^{15}$  [B]  $10x^8$   
[C]  $12x^8$  [D]  $12x^{15}$
2. A hockey team played  $n$  games, losing four of them and winning the rest. The ratio of games won to games lost is  
[A]  $\frac{n-4}{4}$  [B]  $\frac{n}{4}$  [C]  $\frac{4}{n}$  [D]  $\frac{4}{n-4}$

3. In the coordinate plane, what is the total number of points 5 units from the origin and equidistant from both the  $x$ - and  $y$ -axes?  
[A] 1 [B] 2 [C] 4 [D] 0
4. Expressed in decimal notation,  $4.726 \times 10^{-3}$  is  
[A] 0.004726 [B] 0.04726  
[C] 472.6 [D] 4,726

5. Which table does *not* show an example of direct variation?

[A] 

$x$	$y$
1	$\frac{1}{2}$
2	1
3	$\frac{3}{2}$
4	2

[B] 

$x$	$y$
-4	-20
-3	-15
-2	-10
-1	-5

[C] 

$x$	$y$
2	24
4	12
6	8
8	6

[D] 

$x$	$y$
1	4
2	8
3	12
4	16

6. If  $a < b$ ,  $c < d$ , and  $a$ ,  $b$ ,  $c$ , and  $d$  are all greater than 0, which expression is always true?  
[A]  $a + c > b + d$  [B]  $ac < bd$   
[C]  $a - c + b - d = 0$  [D]  $\frac{a}{d} > \frac{b}{c}$
7. The volume of a cube is 64 cubic inches. Its total surface area, in square inches, is  
[A] 576 [B] 48 [C] 16 [D] 96
8. On an English examination, two students received scores of 90, five students received 85, seven students received 75, and one student received 55. The average score on this examination was  
[A] 75 [B] 79 [C] 76 [D] 77

9. Which equation represents a line parallel to the line  $y = 2x - 5$ ?

[A]  $y = -2x - 5$       [B]  $y = 5x - 2$

[C]  $y = -\frac{1}{2}x - 5$       [D]  $y = 2x + 5$

10. The operation  $*$  for the set  $\{p, r, s, v\}$  is defined in the accompanying table. What is the inverse element of  $r$  under the operation  $*$ ?

$*$	$p$	$r$	$s$	$v$
$p$	$s$	$v$	$p$	$r$
$r$	$v$	$p$	$r$	$s$
$s$	$p$	$r$	$s$	$v$
$v$	$r$	$s$	$v$	$p$

[A]  $s$       [B]  $v$       [C]  $r$       [D]  $p$

11. A box contains six black balls and four white balls. What is the probability of selecting a black ball at random from the box?

[A]  $\frac{6}{4}$       [B]  $\frac{6}{10}$       [C]  $\frac{4}{6}$       [D]  $\frac{1}{10}$

12. The solution set for the equation  $x^2 - 2x - 15 = 0$  is

[A]  $\{-5, -3\}$       [B]  $\{5, -3\}$

[C]  $\{5, 3\}$       [D]  $\{-5, 3\}$

13. What is the value of  $y$  in the following system of equations?

$$2x + 3y = 6$$

$$2x + y = -2$$

[A]  $-3$       [B]  $2$       [C]  $1$       [D]  $4$

14. What is the converse of the statement "If it is sunny, I will go swimming"?

[A] If it is not sunny, I will not go swimming.

[B] If I do not go swimming, then it is not sunny.

[C] I will go swimming if and only if it is sunny.

[D] If I go swimming, it is sunny.

15. Solve for  $x$ :  $15x - 3(3x + 4) = 6$

[A]  $3$       [B]  $1$       [C]  $\frac{1}{3}$       [D]  $-\frac{1}{2}$

16. The expression  $2\sqrt{50} - \sqrt{2}$  is equivalent to

[A]  $49\sqrt{2}$       [B]  $2\sqrt{48}$

[C]  $9\sqrt{2}$       [D]  $10$

17. Which is an equation of the parabola shown in the accompanying diagram?

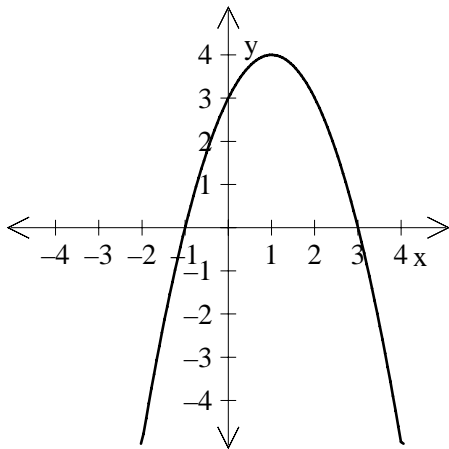

- [A]  $y = x^2 + 2x + 3$     [B]  $y = -x^2 - 2x + 3$   
[C]  $y = x^2 - 2x + 3$     [D]  $y = -x^2 + 2x + 3$

18. If two sides of a triangle are 1 and 3, the third side may be

- [A] 3    [B] 2    [C] 4    [D] 5

19. A girl can ski down a hill five times as fast as she can climb up the same hill. If she can climb up the hill and ski down in a total of 9 minutes, how many minutes does it take her to climb up the hill?

- [A] 7.5    [B] 1.8    [C] 7.2    [D] 4.5

20. When  $3x^2 - 2x + 1$  is subtracted from  $2x^2 + 7x + 5$ , the result will be

- [A]  $x^2 + 5x + 6$     [B]  $-x^2 + 9x + 4$   
[C]  $-x^2 + 5x + 6$     [D]  $x^2 - 9x - 4$

21. The accompanying diagram shows a section of the city of Tacoma. High Road, State Street, and Main Street are parallel and 5 miles apart. Ridge Road is perpendicular to the three parallel streets. The distance between the intersection of Ridge Road and State Street and where the railroad tracks cross State Street is 12 miles. What is the distance between the intersection of Ridge Road and Main Street and where the railroad tracks cross Main Street?

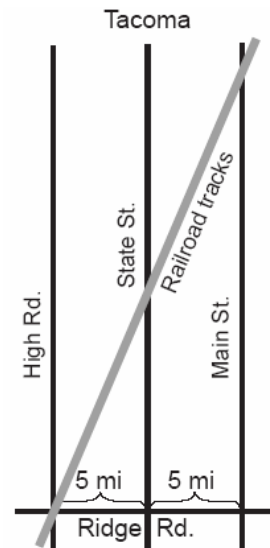

22. Perform the indicated operation and express the result in simplest terms:

$$\frac{x}{x+3} \div \frac{3x}{x^2-9}$$

23. Kerry is planning a rectangular garden that has dimensions of 4 feet by 6 feet. Kerry wants one-half of the garden to have roses, and she says that the rose plot will have dimensions of 2 feet by 3 feet. Is she correct? Explain.



24. The sum of the ages of the three Romano brothers is 63. If their ages can be represented as consecutive integers, what is the age of the middle brother?
25. Alan, Becky, Jesus, and Mariah are four students in the chess club. If two of these students will be selected to represent the school at a national convention, how many combinations of two students are possible?
26. John, Dan, Karen, and Beth went to a costume ball. They chose to go as Anthony and Cleopatra, and Romeo and Juliet. John got the costumes for Romeo and Cleopatra, but not his own costume. Dan saw the costumes for Juliet and himself. Karen went as Anthony. Beth drove two of her friends, who were dressed as Anthony and Cleopatra, to the ball. What costume did John wear?
27. To measure the length of a hiking trail, a worker uses a device with a 2-foot-diameter wheel that counts the number of revolutions the wheel makes. If the device reads 1,100.5 revolutions at the end of the trail, how many miles long is the trail, to the *nearest tenth of a mile*?

28. The coordinates of the endpoints of  $\overline{AB}$  are  $A(2,6)$  and  $B(4,2)$ . Is the image  $\overline{A''B''}$  the same if it is reflected in the  $x$ -axis, then dilated by  $\frac{1}{2}$  as the image is if it is dilated by  $\frac{1}{2}$ , then reflected in the  $x$ -axis? Justify your answer.

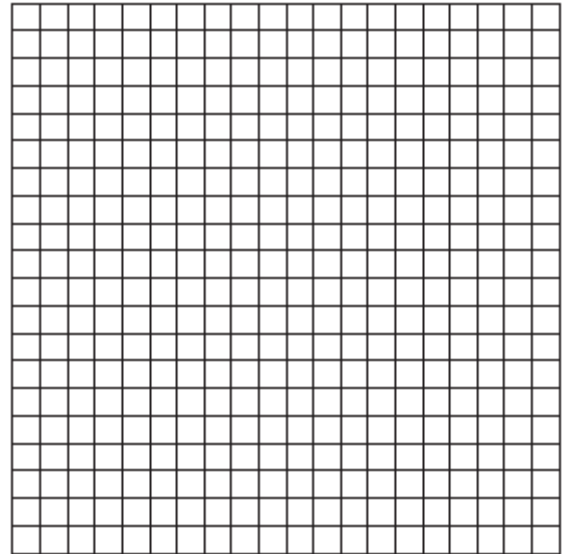

29. After an ice storm, the following headlines were reported in the *Glacier County Times*:  
Monday: Ice Storm Devastates County - 8 out of every 10 homes lose electrical power  
Tuesday: Restoration Begins - Power restored to  $\frac{1}{2}$  of affected homes  
Wednesday: More Freezing Rain - Power lost by 20% of homes that had power on Tuesday  
Based on these headlines, what fractional portion of homes in Glacier County had electrical power on Wednesday?

30. Katrina hikes 5 miles north, 7 miles east, and then 3 miles north again. To the *nearest tenth of a mile*, how far, in a straight line, is Katrina from her starting point?
31. Mr. Santana wants to carpet exactly half of his rectangular living room. He knows that the perimeter of the room is 96 feet and that the length of the room is 6 feet longer than the width. How many square feet of carpeting does Mr. Santana need?
32. Ashanti is surveying for a new parking lot shaped like a parallelogram. She knows that three of the vertices of parallelogram  $ABCD$  are  $A(0,0)$ ,  $B(5,2)$ , and  $C(6,5)$ . Find the coordinates of point  $D$  and sketch parallelogram  $ABCD$  on the accompanying set of axes. Justify mathematically that the figure you have drawn is a parallelogram.

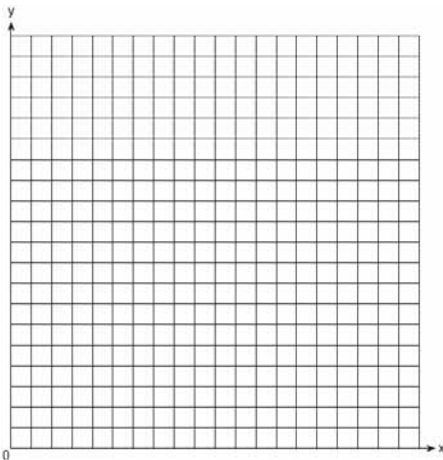

33. A 10-foot ladder is to be placed against the side of a building. The base of the ladder must be placed at an angle of  $72^\circ$  with the level ground for a secure footing. Find, to the *nearest inch*, how far the base of the ladder should be from the side of the building and how far up the side of the building the ladder will reach.
34. The telephone company has run out of seven-digit telephone numbers for an area code. To fix this problem, the telephone company will introduce a new area code. Find the number of new seven-digit telephone numbers that will be generated for the new area code if both of the following conditions must be met:
- o The first digit cannot be a zero or a one.
  - o The first three digits cannot be the emergency number (911) or the number used for information (411).
35. Jack is building a rectangular dog pen that he wishes to enclose. The width of the pen is 2 yards less than the length. If the area of the dog pen is 15 square yards, how many yards of fencing would he need to completely enclose the pen?

1. There are 461 students and 20 teachers taking buses on a trip to a museum. Each bus can seat a maximum of 52. What is the *least* number of buses needed for the trip?

[A] 8 [B] 10 [C] 11 [D] 9

2. In right triangle  $ABC$ ,  $m\angle C = 3y - 10$ ,  $m\angle B = y + 40$ , and  $m\angle A = 90$ . What type of right triangle is triangle  $ABC$ ?

[A] scalene [B] isosceles  
[C] equilateral [D] obtuse

3. If  $x > 0$ , the expression  $(\sqrt{x})(\sqrt{2x})$  is equivalent to

[A]  $x\sqrt{2}$  [B]  $x^2\sqrt{2}$   
[C]  $2x$  [D]  $\sqrt{2x}$

4. Three times as many robins as cardinals visited a bird feeder. If a total of 20 robins and cardinals visited the feeder, how many were robins?

[A] 15 [B] 20 [C] 5 [D] 10

5. One of the factors of  $4x^2 - 9$  is

[A]  $(2x + 3)$  [B]  $(4x - 3)$   
[C]  $(x - 3)$  [D]  $(x + 3)$

6. At a school fair, the spinner represented in the accompanying diagram is spun twice.

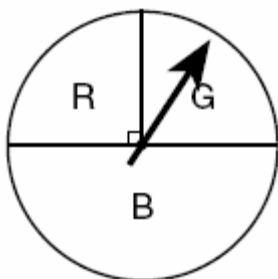

What is the probability that it will land in section  $G$  the first time and then in section  $B$  the second time?

[A]  $\frac{1}{2}$  [B]  $\frac{1}{4}$  [C]  $\frac{1}{8}$  [D]  $\frac{1}{16}$

7. If  $a$  and  $b$  are integers, which equation is always true?

[A]  $a + b = b + a$  [B]  $a + 2b = b + 2a$   
[C]  $a - b = b - a$  [D]  $\frac{a}{b} = \frac{b}{a}$

8. The sum of  $3x^2 + 4x - 2$  and  $x^2 - 5x + 3$  is

[A]  $4x^2 + x + 1$  [B]  $4x^2 + x - 1$   
[C]  $4x^2 - x - 1$  [D]  $4x^2 - x + 1$

9. If  $x \neq 0$ , the expression  $\frac{x^2 + 2x}{x}$  is equivalent to

[A]  $x + 2$  [B]  $3x$  [C]  $2$  [D]  $4$

10. Helen is using a capital H in an art design. The H has

[A] only two points of symmetry  
[B] two lines of symmetry and two points of symmetry  
[C] only one line of symmetry  
[D] two lines of symmetry and only one point of symmetry

11. The distance from Earth to the Sun is approximately 93 million miles. A scientist would write that number as

[A]  $9.3 \times 10^7$  [B]  $9.3 \times 10^6$   
[C]  $93 \times 10^{10}$  [D]  $93 \times 10^7$

12. Given the statement: "If two sides of a triangle are congruent, then the angles opposite these sides are congruent."

Given the converse of the statement: "If two angles of a triangle are congruent, then the sides opposite these angles are congruent."

What is true about this statement and its converse?

- [A] The statement is false but its converse is true.  
 [B] The statement is true but its converse is false.  
 [C] Neither the statement nor its converse is true.  
 [D] Both the statement and its converse are true.
13. Which equation could represent the relationship between the  $x$  and  $y$  values shown in the accompanying table?

$x$	$y$
0	2
1	3
2	6
3	11
4	18

- [A]  $y = x^2 + 2$       [B]  $y = x + 2$   
 [C]  $y = 2^x$       [D]  $y = x^2$
14. A locker combination system uses three digits from 0 to 9. How many different three-digit combinations with no digit repeated are possible?  
 [A] 504    [B] 1,000    [C] 30    [D] 720

15. What is the slope of line  $\ell$  in the accompanying diagram?

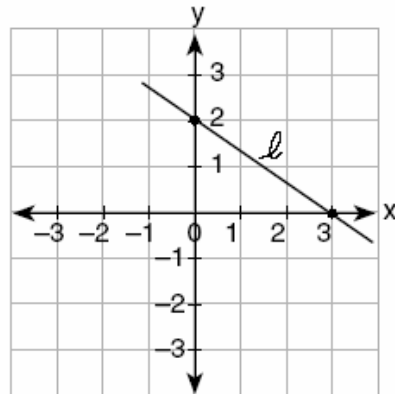

- [A]  $\frac{3}{2}$     [B]  $-\frac{3}{2}$     [C]  $-\frac{2}{3}$     [D]  $\frac{2}{3}$
16. If  $bx - 2 = K$ , then  $x$  equals  
 [A]  $\frac{K-2}{b}$       [B]  $\frac{2-K}{b}$   
 [C]  $\frac{K+2}{b}$       [D]  $\frac{K}{b} + 2$
17. In a molecule of water, there are two atoms of hydrogen and one atom of oxygen. How many atoms of hydrogen are in 28 molecules of water?  
 [A] 56    [B] 14    [C] 29    [D] 42
18. From January 3 to January 7, Buffalo recorded the following daily high temperatures:  $5^\circ$ ,  $7^\circ$ ,  $6^\circ$ ,  $5^\circ$ , and  $7^\circ$ . Which statement about the temperatures is true?  
 [A] median = mode      [B] mean = mode  
 [C] mean < median      [D] mean = median

19. In which of the accompanying figures are segments  $XY$  and  $YZ$  perpendicular?

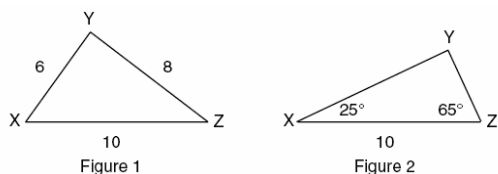

- [A] both figure 1 and figure 2  
[B] figure 2 only  
[C] neither figure 1 nor figure 2  
[D] figure 1, only

20. Let  $x$  and  $y$  be numbers such that  $0 < x < y < 1$ , and let  $d = x - y$ . Which graph could represent the location of  $d$  on the number line?

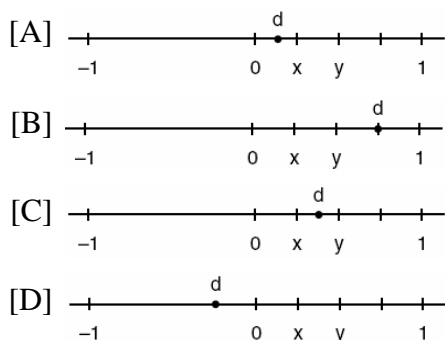

21. The accompanying graph shows Marie's distance from home ( $A$ ) to work ( $F$ ) at various times during her drive.

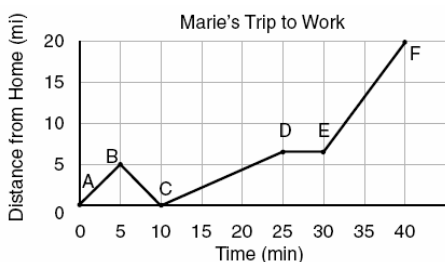

- a* Marie left her briefcase at home and had to return to get it. State which point represents when she turned back around to go home and explain how you arrived at that conclusion.  
*b* Marie also had to wait at the railroad tracks for a train to pass. How long did she wait?

22. Sue bought a picnic table on sale for 50% off the original price. The store charged her 10% tax and her final cost was \$22.00. What was the original price of the picnic table?

23. A cardboard box has length  $x - 2$ , width  $x + 1$ , and height  $2x$ .  
*a* Write an expression, in terms of  $x$ , to represent the volume of the box.  
*b* If  $x = 8$  centimeters, what is the number of cubic centimeters in the volume of the box?

24. The coordinates of the endpoints of  $\overline{AB}$  are  $A(0,2)$  and  $B(4,6)$ . Graph and state the coordinates of  $A'$  and  $B'$ , the images of  $A$  and  $B$  after  $\overline{AB}$  is reflected in the  $x$ -axis.

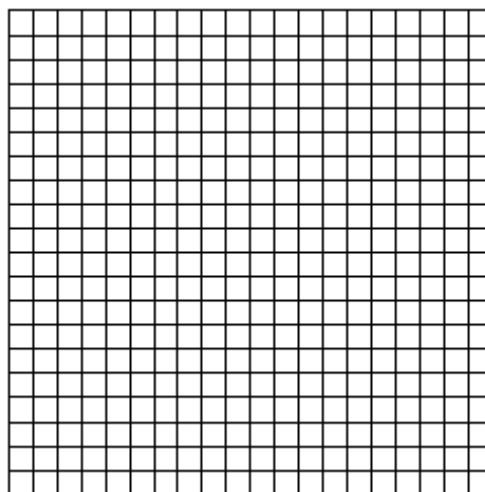

25. Two trains leave the same station at the same time and travel in opposite directions. One train travels at 80 kilometers per hour and the other at 100 kilometers per hour. In how many hours will they be 900 kilometers apart?

26. Sal has a small bag of candy containing three green candies and two red candies. While waiting for the bus, he ate two candies out of the bag, one after another, without looking. What is the probability that both candies were the same color?

27. Steve has a treasure map, represented in the accompanying diagram, that shows two trees 8 feet apart and a straight fence connecting them. The map states that treasure is buried 3 feet from the fence and equidistant from the two trees.

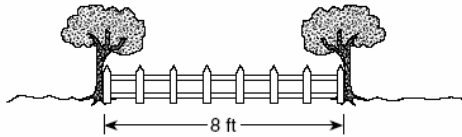

- a Sketch a diagram to show all the places where the treasure could be buried. Clearly indicate in your diagram where the treasure could be buried.
- b What is the distance between the treasure and one of the trees?

28. In the accompanying figure, two lines intersect,  $m\angle 3 = 6t + 30$ , and  $m\angle 2 = 8t - 60$ . Find the number of degrees in  $m\angle 4$ .

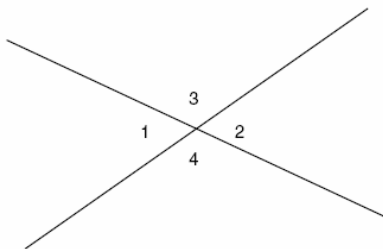

29. Mark says, "The number I see is odd." Jan says, "That same number is prime." The teacher says, "Mark is correct or Jan is correct." Some integers would make the teacher's statement true while other integers would make it false. Give and explain one example of when the teacher's statement is true. Give and explain one example of when the teacher's statement is false.
30. Juan has a cellular phone that costs \$12.95 per month plus 25¢ per minute for each call. Tiffany has a cellular phone that costs \$14.95 per month plus 15¢ per minute for each call. For what number of minutes do the two plans cost the same?

31. Solve algebraically for  $x$ :  $\frac{1}{x} = \frac{x+1}{6}$

32. On a science quiz, 20 students received the following scores: 100, 95, 95, 90, 85, 85, 85, 80, 80, 80, 80, 80, 75, 75, 75, 70, 70, 65, 65, 60, 55. Construct a statistical graph, such as a histogram or a stem-and-leaf plot, to display this data. [Be sure to title the graph and label all axes or parts used.] If your type of plot requires a grid, show your work here.

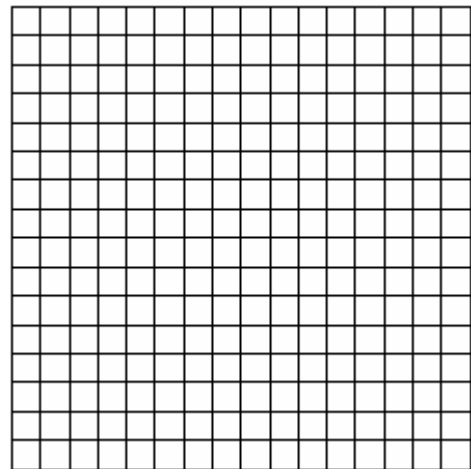

If no grid is necessary, show your work here.

33. John uses the equation  $x^2 + y^2 = 9$  to represent the shape of a garden on graph paper.
- a Graph  $x^2 + y^2 = 9$  on the accompanying grid.

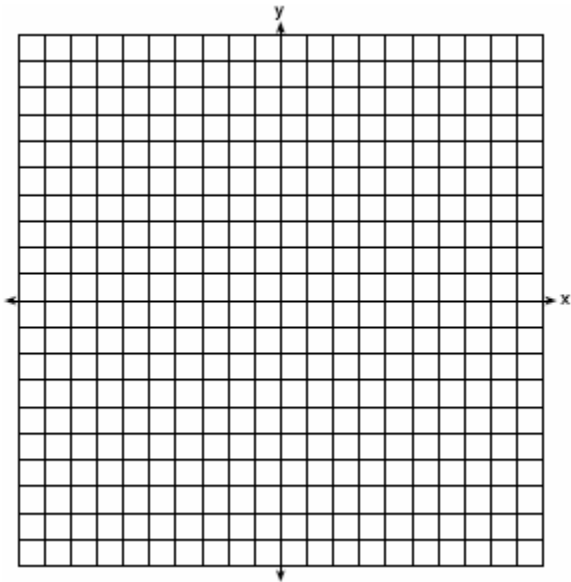

b What is the area of the garden to the nearest square unit?

34. There were 100 more balcony tickets than main-floor tickets sold for a concert. The balcony tickets sold for \$4 and the main-floor tickets sold for \$12. The total amount of sales for both types of tickets was \$3,056.
- a Write an equation or a system of equations that describes the given situation. Define the variables.
- b Find the number of balcony tickets that were sold.

35. Find, to the nearest tenth of a foot, the height of the tree represented in the accompanying diagram.

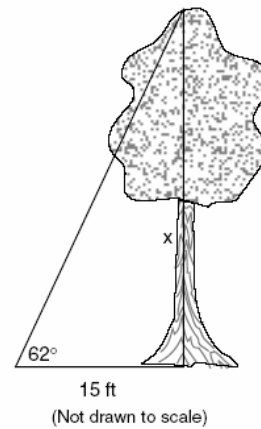

- A car travels 110 miles in 2 hours. At the same rate of speed, how far will the car travel in  $h$  hours?  
[A]  $\frac{h}{220}$  [B]  $220h$  [C]  $55h$  [D]  $\frac{h}{55}$
- Which polynomial is the quotient of  $\frac{6x^3 + 9x^2 + 3x}{3x}$ ?  
[A]  $2x^2 + 3x + 1$  [B]  $6x^2 + 9x$   
[C]  $2x^2 + 3x$  [D]  $2x + 3$
- If the length of a rectangular prism is doubled, its width is tripled, and its height remains the same, what is the volume of the new rectangular prism?  
[A] double the original volume  
[B] nine times the original volume  
[C] triple the original volume  
[D] six times the original volume
- One root of the equation  $2x^2 - x - 15 = 0$  is  
[A]  $\frac{5}{2}$  [B] 3 [C]  $\frac{3}{2}$  [D] -3
- Which properties best describe the coordinate graph of two distinct parallel lines?  
[A] different slopes and different intercepts  
[B] same slopes and different intercepts  
[C] different slopes and same intercepts  
[D] same slopes and same intercepts
- Which statement is *not* always true about a parallelogram?  
[A] The opposite angles are congruent.  
[B] The opposite sides are congruent.  
[C] The diagonals are congruent.  
[D] The opposite sides are parallel.
- In isosceles triangle  $DOG$ , the measure of the vertex angle is three times the measure of one of the base angles. Which statement about  $\triangle DOG$  is true?  
[A]  $\triangle DOG$  is a scalene triangle.  
[B]  $\triangle DOG$  is a right triangle.  
[C]  $\triangle DOG$  is an acute triangle.  
[D]  $\triangle DOG$  is an obtuse triangle.



8. Which equation illustrates the distributive property for real numbers?  
[A]  $\frac{1}{3} + \frac{1}{2} = \frac{1}{2} + \frac{1}{3}$       [B]  $\sqrt{3} + 0 = \sqrt{3}$   
[C]  $-3(5 + 7) = (-3)(5) + (-3)(7)$   
[D]  $(1.3 \times 0.07) \times 0.63 = 1.3 \times (0.07 \times 0.63)$
9. Factor completely:  $3x^2 - 27$   
[A]  $3(x + 3)(x - 3)$       [B]  $(3x + 3)(x - 9)$   
[C]  $3(x - 3)^2$       [D]  $3(x^2 - 27)$
10. At a school costume party, seven girls wore masks and nine boys did not. If there were 15 boys at the party and 20 students did not wear masks, what was the total number of students at the party?  
[A] 30      [B] 42      [C] 33      [D] 35
11. If one-half of a number is 8 less than two-thirds of the number, what is the number?  
[A] 32      [B] 48      [C] 54      [D] 24
12. Which statement is logically equivalent to "If I eat, then I live"?  
[A] If I eat, then I do not live.  
[B] If I live, then I eat.  
[C] If I do not live, then I do not eat.  
[D] I live if and only if I eat.
13. If  $a$  is an odd number,  $b$  an even number, and  $c$  an odd number, which expression will always be equivalent to an odd number?  
[A]  $ac(b)^0$       [B]  $a(bc)$   
[C]  $ac(b)^1$       [D]  $ac(b)^2$
14. If there are four teams in a league, how many games will have to be played so that each team plays every other team once?  
[A] 16      [B] 3      [C] 8      [D] 6
15. A woman has a ladder that is 13 feet long. If she sets the base of the ladder on level ground 5 feet from the side of a house, how many feet above the ground will the top of the ladder be when it rests against the house?  
[A] 9      [B] 8      [C] 12      [D] 11

16. A boy got 50% of the questions on a test correct. If he had 10 questions correct out of the first 12, and  $\frac{1}{4}$  of the remaining questions correct, how many questions were on the test?  
[A] 28    [B] 26    [C] 24    [D] 16

17. A hotel charges \$20 for the use of its dining room and \$2.50 a plate for each dinner. An association gives a dinner and charges \$3 a plate but invites four nonpaying guests. If each person has one plate, how many paying persons must attend for the association to collect the exact amount needed to pay the hotel?  
[A] 44    [B] 40    [C] 60    [D] 20

18. In the set of positive integers, what is the solution set of the inequality  $2x - 3 < 5$ ?  
[A] {1, 2, 3}                      [B] {0, 1, 2, 3}  
[C] {1, 2, 3, 4}                    [D] {0, 1, 2, 3, 4}

19. What is the total number of points of intersection in the graphs of the equations  $x^2 + y^2 = 16$  and  $y = 4$ ?  
[A] 0    [B] 1    [C] 2    [D] 3

20. Which is a rational number?  
[A]  $6\sqrt{2}$     [B]  $5\sqrt{9}$     [C]  $\sqrt{8}$     [D]  $\pi$

21. A school district offers hockey and basketball. The result of a survey of 300 students showed:  
120 students play hockey, only  
90 students play basketball, only  
30 students do not participate in either sport  
Of those surveyed, how many students play both hockey and basketball?

22. In the accompanying diagram, parallel lines  $\overline{AB}$  and  $\overline{CD}$  are intersected by transversal  $\overline{EF}$  at points  $X$  and  $Y$ , and  $m\angle FYD = 123$ . Find  $m\angle AXY$ .

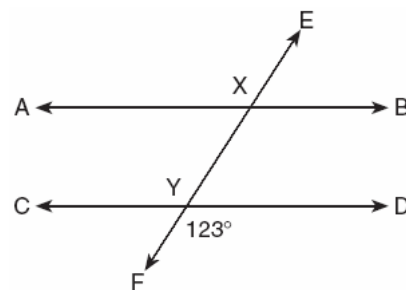

23. Ben had twice as many nickels as dimes. Altogether, Ben had \$4.20. How many nickels *and* how many dimes did Ben have?

24. If a girl 1.2 meters tall casts a shadow 2 meters long, how many meters tall is a tree that casts a shadow 75 meters long at the same time?

25. There were seven students running in a race. How many different arrangements of first, second, and third place are possible?

26. In the accompanying diagram of parallelogram  $ABCD$ ,  $m\angle A = (2x + 10)$  and  $m\angle B = 3x$ . Find the number of degrees in  $m\angle B$ .

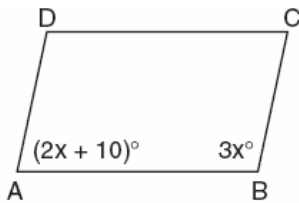

27. A factory packs CD cases into cartons for a music company. Each carton is designed to hold 1,152 CD cases. The Quality Control Unit in the factory expects an error of less than 5% over or under the desired packing number. What is the *least* number and the *most* number of CD cases that could be packed in a carton and still be acceptable to the Quality Control Unit?

28. Connor wants to compare Celsius and Fahrenheit temperatures by drawing a conversion graph. He knows that  $-40^\circ C = -40^\circ F$  and that  $20^\circ C = 68^\circ F$ . On the accompanying grid, construct the conversion graph and, using the graph, determine the Celsius equivalent of  $25^\circ F$ .

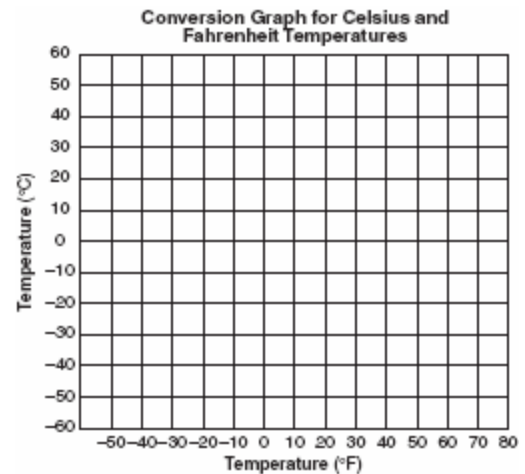

29. Virginia has a circular rug on her square living room floor, as represented in the accompanying diagram. If her entire living room floor measures 100 square feet, what is the area of the part of the floor covered by the rug?

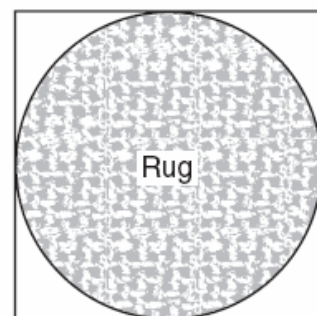

30. Mr. Yee has 10 boys and 15 girls in his mathematics class. If he chooses two students at random to work on the blackboard, what is the probability that both students chosen are girls?

31. Find three consecutive odd integers such that the product of the first and the second exceeds the third by 8.

32. Keesha wants to tile the floor shown in the accompanying diagram. If each tile measures 1 foot by 1 foot and costs \$2.99, what will be the total cost, including an 8% sales tax, for tiling the floor?

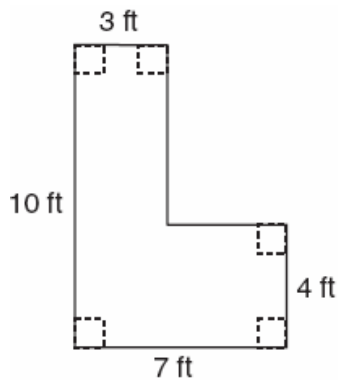

33. Ramón rented a sprayer and a generator. On his first job, he used each piece of equipment for 6 hours at a total cost of \$90. On his second job, he used the sprayer for 4 hours and the generator for 8 hours at a total cost of \$100. What was the hourly cost of *each* piece of equipment?

34. The plan of a parcel of land is represented by trapezoid  $ABCD$  in the accompanying diagram. If the area of  $\triangle ABE$  is 600 square feet, find the minimum number of feet of fence needed to completely enclose the entire parcel of land,  $ABCD$ .

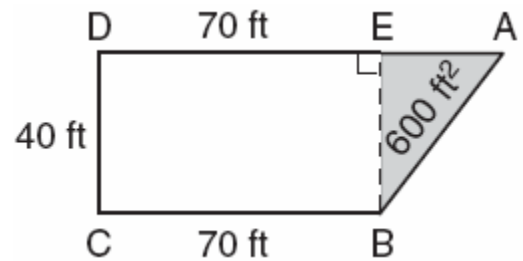

35. Triangle  $SUN$  has coordinates  $S(0,6)$ ,  $U(3,5)$ , and  $N(3,0)$ . On the accompanying grid, draw and label  $\triangle SUN$ . Then, graph and state the coordinates of  $\triangle S'U'N'$ , the image of  $\triangle SUN$  after a reflection in the  $y$ -axis.

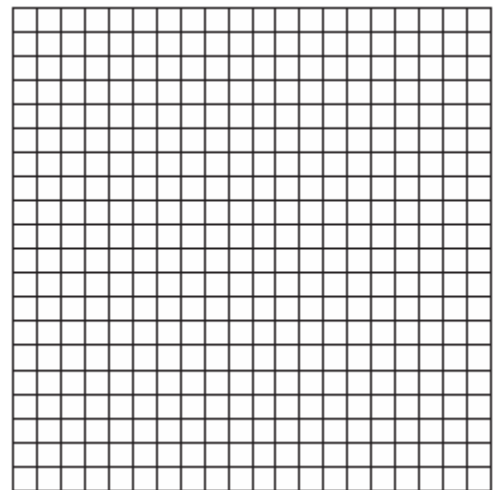

1. The perimeter of an equilateral triangle varies directly as the length of a side. When the length of a side is doubled, the perimeter of the triangle is

[A] halved                      [B] doubled  
[C] multiplied by 3      [D] divided by 3

2. Which expression is rational?

[A]  $\sqrt{\frac{1}{2}}$     [B]  $\sqrt{\frac{1}{4}}$     [C]  $\pi$     [D]  $\sqrt{3}$

3. Written in simplest factored form, the binomial  $2x^2 - 50$  can be expressed as

[A]  $(x - 5)(x + 5)$       [B]  $2x(x - 50)$   
[C]  $2(x - 5)(x - 5)$       [D]  $2(x - 5)(x + 5)$

4. Which statement is logically equivalent to "If I did not eat, then I am hungry"?

[A] If I did not eat, then I am not hungry.  
[B] If I am not hungry, then I did not eat.  
[C] If I am not hungry, then I did eat.  
[D] If I am hungry, then I did eat.

5. In the accompanying diagram, a circle with radius 4 is inscribed in a square.

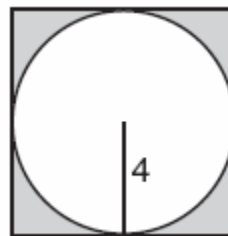

What is the area of the shaded region?

[A]  $64 - 16\pi$                       [B]  $16 - 8\pi$   
[C]  $64\pi - 8\pi$                       [D]  $16 - 16\pi$

6. Which letter below has point symmetry, but does not have line symmetry?

[A] H      [B] N      [C] A      [D] E

7. The value of  $5!$  is

[A] 20    [B] 5    [C] 120    [D]  $\frac{1}{5}$

8. What is the approximate circumference of a circle with radius 3?

[A] 7.07                      [B] 18.85  
[C] 28.27                      [D] 9.42

9. The sum of the measures of the interior angles of an octagon is  
 [A]  $540^\circ$  [B]  $180^\circ$   
 [C]  $1,080^\circ$  [D]  $360^\circ$
10. The exact average of a set of six test scores is 92. Five of these scores are 90, 98, 96, 94, and 85. What is the other test score?  
 [A] 89 [B] 92 [C] 86 [D] 91
11. A certain car comes in three body styles with a choice of two engines, a choice of two transmissions, and a choice of six colors. What is the minimum number of cars a dealer must stock to have one car of every possible combination?  
 [A] 42 [B] 72 [C] 13 [D] 36
12. The operation element @ is determined by the following table:

@	a	b	c
a	a	b	c
b	b	c	a
c	c	a	b

What is the identity element of this operation?

- [A]  $a$  and  $b$  [B]  $c$   
 [C]  $b$ , only [D]  $a$ , only
13. If  $n$  represents an odd number, which computation results in an answer that is an even number?  
 [A]  $2 \times n - 1$  [B]  $2 \times n + 1$   
 [C]  $3 \times n + 1$  [D]  $3 \times n - 2$
14. In his will, a man leaves one-half of his money to his wife, one-half of what is then left to his older child, and one-half of what is then left to his younger child. His two cousins divide the remainder equally, each receiving \$2,000. What was the total amount of money in the man's will?  
 [A] \$32,000 [B] \$40,000  
 [C] \$16,000 [D] \$24,000
15. If  $a + b$  is less than  $c + d$ , and  $d + e$  is less than  $a + b$ , then  $e$  is  
 [A] less than  $d$  [B] less than  $c$   
 [C] greater than  $d$  [D] equal to  $c$
16. Which statement is the converse of "If it is a 300 ZX, then it is a car" ?  
 [A] If it is a car, then it is not a 300 ZX.  
 [B] If it is not a 300 ZX, then it is not a car.  
 [C] If it is a car, then it is a 300 ZX.  
 [D] If it is not a car, then it is not a 300 ZX.

17. In a class of 450 students, 300 are taking a mathematics course and 260 are taking a science course. If 140 of these students are taking both courses, how many students are not taking either of these courses?

[A] 30    [B] 40    [C] 140    [D] 110

18. What is the solution set of  $m^2 - 3m - 10 = 0$ ?

[A] {3,-10}                      [B] {5,-2}  
[C] {3,10}                        [D] {2,-5}

19. Which expression is equivalent to  $x^{-1} \cdot y^2$ ?

[A]  $xy^{-2}$     [B]  $\frac{y^2}{x}$     [C]  $\frac{x}{y^2}$     [D]  $xy^2$

20. What is the smallest integer greater than 1 that is both the square of an integer and the cube of an integer?

[A] 36    [B] 8    [C] 64    [D] 9

21. Triangle  $ABC$ , with side  $\overline{AC}$  extended to  $D$ , is shown in the accompanying diagram. If  $m\angle ABC = 63$  and  $m\angle BCD = 92$ , what is  $m\angle BAC$ ?

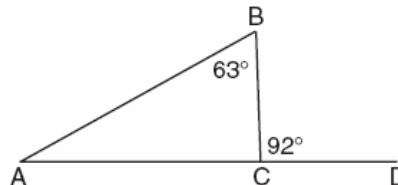

22. How many feet from the base of a house must a 39-foot ladder be placed so that the top of the ladder will reach a point on the house 36 feet from the ground?

23. Subtract  $5x^2 - 7x - 6$  from  $9x^2 + 3x - 4$ .

24. An engineer measured the dimensions for a rectangular site by using a wooden pole of unknown length  $x$ . The length of the rectangular site is 2 pole measures increased by 3 feet, while the width is 1 pole measure decreased by 4 feet. Write an algebraic representation, in terms of  $x$ , for the perimeter of the site.

25. Simplify:  $\sqrt{50r^2s^4}$

26. Megan decides to go out to eat. The menu at the restaurant has four appetizers, three soups, seven entrees, and five desserts. If Megan decides to order an appetizer *or* a soup, and one entree, and two different desserts, how many different choices can she make?
27. There are four students, all of different heights, who are to be randomly arranged in a line. What is the probability that the tallest student will be first in line and the shortest student will be last in line?
28. On the accompanying set of axes, graph  $\triangle ABC$  with coordinates  $A(-1,2)$ ,  $B(0,6)$ , and  $C(5,4)$ . Then graph  $\triangle A'B'C'$ , the image of  $\triangle ABC$  after a dilation of 2.

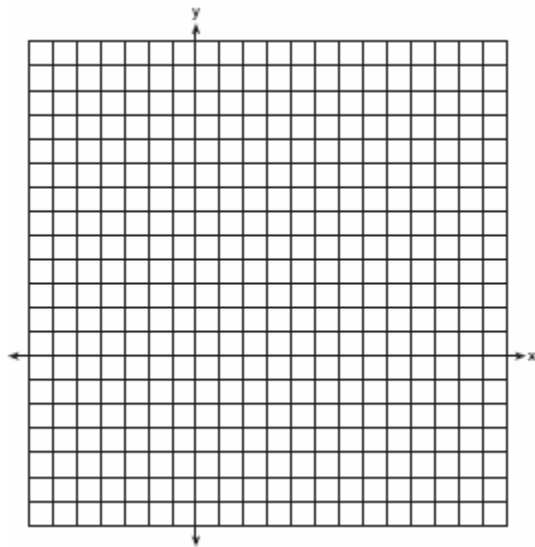

29. Ramón said that the set of integers is *not* closed for one of the basic operations (addition, subtraction, multiplication, or division). You want to show Ramón that his statement is correct. For the operation for which the set of integers is *not* closed, write an example using:
- o a positive even integer and a zero
  - o a positive and a negative even integer
  - o two negative even integers
- Be sure to explain why *each* of your examples illustrates that the set of integers is *not* closed for that operation.
30. Shanaya graphed the line represented by the equation  $y = x - 6$ . Write an equation for a line that is parallel to the given line. Write an equation for a line that is perpendicular to the given line. Write an equation for a line that is identical to the given line but has different coefficients.
31. Point  $P$  is located on  $\overline{AB}$ .
- a Describe the locus of points that are
    - (1) 3 units from  $\overline{AB}$
    - (2) 5 units from point  $P$
  - b How many points satisfy both conditions in part a?



32. The ninth graders at a high school are raising money by selling T-shirts and baseball caps. The number of T-shirts sold was three times the number of caps. The profit they received for each T-shirt sold was \$5.00, and the profit on each cap was \$2.50. If the students made a total profit of \$210, how many T-shirts *and* how many caps were sold?

33. A ship on the ocean surface detects a sunken ship on the ocean floor at an angle of depression of  $50^\circ$ . The distance between the ship on the surface and the sunken ship on the ocean floor is 200 meters. If the ocean floor is level in this area, how far above the ocean floor, to the *nearest meter*, is the ship on the surface?

34. The following data consists of the weights, in pounds, of 30 adults:

195, 206, 100, 98, 150, 210, 195, 106, 195, 168, 180, 212, 104, 195, 100, 216, 195, 209, 112, 99, 206, 116, 195, 100, 142, 100, 135, 98, 160, 155

Using the data, complete the accompanying cumulative frequency table and construct a cumulative frequency histogram on the grid below.

Interval	Frequency	Cumulative Frequency
51–100		
101–150		
151–200		
201–250		

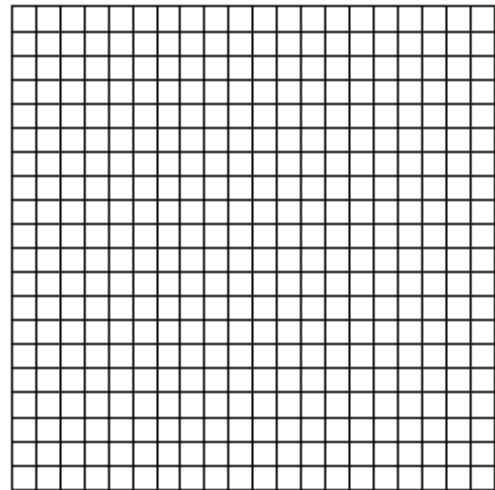

35. Solve the following system of equations algebraically.

$$y = x^2 + 4x - 2$$

$$y = 2x + 1$$

- Expressed in factored form, the binomial  $4a^2 - 9b^2$  is equivalent to  
[A]  $(2a - 9b)(2a + b)$   
[B]  $(2a + 3b)(2a - 3b)$   
[C]  $(4a - 3b)(a + 3b)$   
[D]  $(2a - 3b)(2a - 3b)$
- If the length of the legs of a right triangle are 5 and 7, what is the length of the hypotenuse?  
[A]  $2\sqrt{3}$  [B]  $\sqrt{2}$   
[C]  $2\sqrt{6}$  [D]  $\sqrt{74}$
- What is the slope of the line whose equation is  $2y = 5x + 4$ ?  
[A]  $\frac{5}{2}$  [B] 2 [C]  $\frac{2}{5}$  [D] 5
- What is the value of  $x$  in the equation  $\frac{3}{4}x + 2 = \frac{5}{4}x - 6$ ?  
[A] 16 [B] -16 [C] 4 [D] -4
- The product of  $3x^2y$  and  $-4xy^3$  is  
[A]  $12x^2y^3$  [B]  $-12x^3y^4$   
[C]  $12x^3y^4$  [D]  $-12x^2y^3$
- The approximate number of seconds in a year is 32,000,000. When this number is written in scientific notation, the numerical value of the exponent is  
[A] 8 [B] -7 [C] 6 [D] 7
- Which expression must be added to  $3x - 7$  to equal 0?  
[A] 0 [B]  $3x + 7$   
[C]  $-3x + 7$  [D]  $-3x - 7$
- What is the greatest possible number of points of intersection of a triangle and a circle?  
[A] 6 [B] 4 [C] 2 [D] 3
- A fair coin is tossed three times. What is the probability that the coin will land tails up on the second toss?  
[A]  $\frac{1}{3}$  [B]  $\frac{1}{2}$  [C]  $\frac{3}{4}$  [D]  $\frac{2}{3}$
- There are 357 seniors in Harris High School. The ratio of boys to girls is 7:10. How many boys are in the senior class?  
[A] 117 [B] 147 [C] 107 [D] 210

11. If  $x$  and  $y$  are defined as indicated by the accompanying table, which equation correctly represents the relationship between  $x$  and  $y$ ?

$x$	$y$
2	1
3	3
5	7
7	11

- [A]  $y = 2x + 3$       [B]  $y = x + 2$   
[C]  $y = 2x - 3$       [D]  $y = 2x + 2$

12. What is the area of a square whose perimeter is represented by  $12x$ ?

- [A]  $9x^2$       [B]  $6x\sqrt{2}$   
[C]  $12x^2$       [D]  $144x^2$

13. Which inequality is true if  $x = \frac{3.04}{1.48}$ ,  $y = 1.99 + 0.33$ , and  $z = (1.3)^3$ ?

- [A]  $x < y < z$       [B]  $x < z < y$   
[C]  $y < x < z$       [D]  $y < z < x$

14. Frank, George, and Hernando are a plumber, a cabinet maker, and an electrician, though not necessarily in that order. Each can do all work appropriate to his own field, but no work in other fields. Frank was not able to install a new electric line in his home. Hernando was not able to make cabinets. George is also a building contractor who hired one of the other people to do his electrical work. Which statement must be true?

- [A] Frank is an electrician.  
[B] George is a cabinet maker.  
[C] Hernando is an electrician.  
[D] Frank is a plumber.

15. What is the solution set of the equation  $3x^2 = 48$ ?

- [A]  $\{4, -4\}$       [B]  $\{-2, -8\}$   
[C]  $\{2, 8\}$       [D]  $\{4, 4\}$

16. In the accompanying diagram,  $\overline{ABCD}$  is a straight line, and angle  $E$  in triangle  $BEC$  is a right angle.

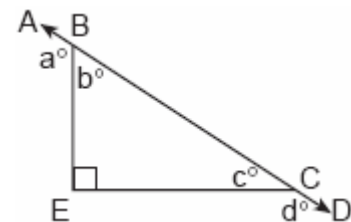

What does  $a^\circ + d^\circ$  equal?

- [A]  $135^\circ$       [B]  $160^\circ$   
[C]  $270^\circ$       [D]  $180^\circ$

17. Which set is closed under division?  
[A]  $\{1\}$       [B] whole numbers  
[C] counting numbers      [D] integers
18. When Kimberly bought her new car, she found that there were 72 different ways her car could be equipped. Her choices included four choices of engine and three choices of transmission. If her only other choice was color, how many choices of color did she have?  
[A] 60      [B] 6      [C] 12      [D] 65
19. Which is an irrational number?  
[A] 3.14      [B]  $\frac{3}{4}$       [C]  $\sqrt{3}$       [D]  $\sqrt{9}$
20. Which statement is logically equivalent to "If the team has a good pitcher, then the team has a good season"?  
[A] If the team does not have a good pitcher, then the team does not have a good season.  
[B] The team has a good pitcher and the team does not have a good season.  
[C] If the team does not have a good season, then the team does not have a good pitcher.  
[D] If the team has a good season, then the team has a good pitcher.
21. Seth is thinking of a number between 20 and 30. The number is prime and not more than 2 away from a perfect square. What is the number?
22. A 12-foot tree casts a 16-foot shadow. How many feet tall is a nearby tree that casts a 20-foot shadow at the same time?
23. Vertex angle  $A$  of isosceles triangle  $ABC$  measures  $20^\circ$  more than three times  $m\angle B$ . Find  $m\angle C$ .
24. Ashanti and Maria went to the store to buy snacks for their back-to-school party. They bought bags of chips, pretzels, and nachos. They bought three times as many bags of pretzels as bags of chips, and two fewer bags of nachos than bags of pretzels. If  $x$  represents the number of bags of chips they bought, express, in terms of  $x$ , how many bags of snacks they bought in all.
25. Construct a triangle with sides of lengths  $a$ ,  $b$ , and  $c$ , as shown below. Be sure the longest side of your triangle lies on  $\overline{PQ}$  and that point  $P$  is one of the triangle's vertices. [Show all arcs necessary for a valid construction.]

a \_\_\_\_\_  
b \_\_\_\_\_  
c \_\_\_\_\_



26. Jerry and Jean Jogger start at the same time from point A shown on the accompanying set of axes. Jerry jogs at a rate of 5 miles per hour traveling from point A to point R to point S and then to point C. Jean jogs directly from point A to point C on  $\overline{AC}$  at the rate of 3 miles per hour. Which jogger reaches point C first? Explain or show your reasoning.

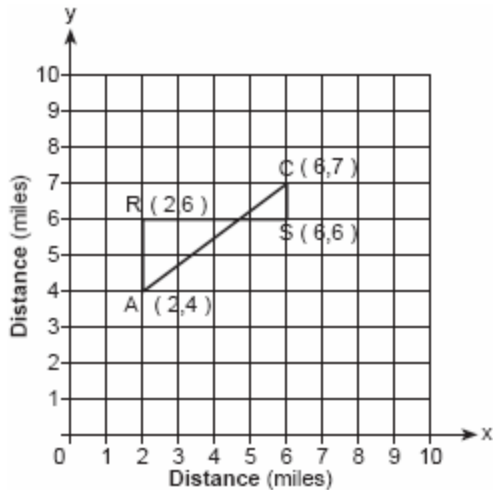

27. In the accompanying diagram, a rectangular container with the dimensions 10 inches by 15 inches by 20 inches is to be filled with water, using a cylindrical cup whose radius is 2 inches and whose height is 5 inches. What is the maximum number of full cups of water that can be placed into the container without the water overflowing the container?

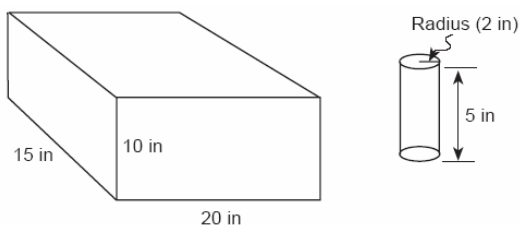

28. A total of 600 tickets were sold for a concert. Twice as many tickets were sold in advance than were sold at the door. If the tickets sold in advance cost \$25 each and the tickets sold at the door cost \$32 each, how much money was collected for the concert?

29. In the accompanying diagram,  $\overline{AB}$  and  $\overline{CD}$  intersect at  $E$ . If  $m\angle AEC = 4x - 40$  and  $m\angle BED = x + 50$ , find the number of degrees in  $\angle AEC$ .

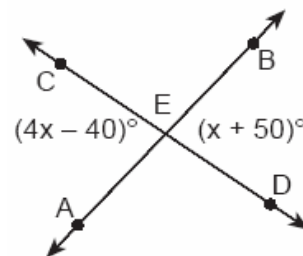

30. The students in Woodland High School's meteorology class measured the noon temperature every schoolday for a week. Their readings for the first 4 days were Monday,  $56^\circ$ ; Tuesday,  $72^\circ$ ; Wednesday,  $67^\circ$ ; and Thursday,  $61^\circ$ . If the mean (average) temperature for the 5 days was exactly  $63^\circ$ , what was the temperature on Friday?

31. A square dartboard is represented in the accompanying diagram. The entire dartboard is the first quadrant from  $x = 0$  to 6 and from  $y = 0$  to 6. A triangular region on the dartboard is enclosed by the graphs of the equations  $y = 2$ ,  $x = 6$ , and  $y = x$ . Find the probability that a dart that randomly hits the dartboard will land in the triangular region formed by the three lines.

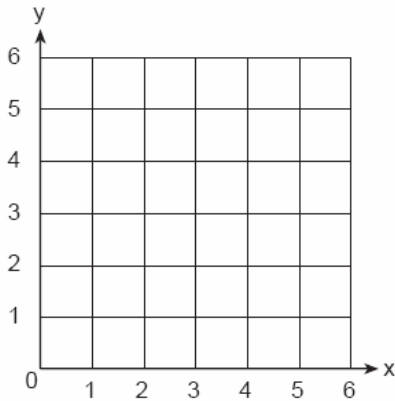

32. When Tony received his weekly allowance, he decided to purchase candy bars for all his friends. Tony bought three Milk Chocolate bars and four Creamy Nougat bars, which cost a total of \$4.25 without tax. Then he realized this candy would not be enough for all his friends, so he returned to the store and bought an additional six Milk Chocolate bars and four Creamy Nougat bars, which cost a total of \$6.50 without tax. How much did *each* type of candy bar cost?

33. Javon's homework is to determine the dimensions of his rectangular backyard. He knows that the length is 10 feet more than the width, and the total area is 144 square feet. Write an equation that Javon could use to solve this problem. Then find the dimensions, in feet, of his backyard.

34. A company manufactures bicycles and skateboards. The company's daily production of bicycles cannot exceed 10, and its daily production of skateboards must be less than or equal to 12. The combined number of bicycles and skateboards cannot be more than 16. If  $x$  is the number of bicycles and  $y$  is the number of skateboards, graph on the accompanying set of axes the region that contains the number of bicycles and skateboards the company can manufacture daily.

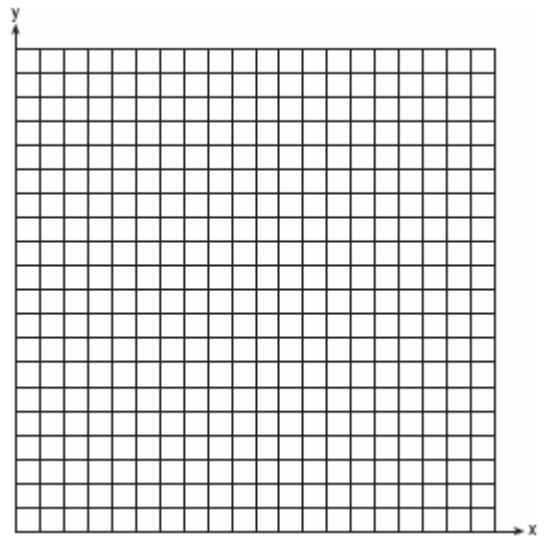

35. Draw and label a diagram of the path of an airplane climbing at an angle of  $11^\circ$  with the ground. Find, to the *nearest foot*, the ground distance the airplane has traveled when it has attained an altitude of 400 feet.

1. Jamie is 5 years older than her sister Amy. If the sum of their ages is 19, how old is Jamie?

[A] 7      [B] 14      [C] 12      [D] 5

2. If the probability that it will rain on Thursday is  $\frac{5}{6}$ , what is the probability that it will *not* rain on Thursday?

[A] 1      [B]  $\frac{1}{6}$       [C] 0      [D]  $\frac{5}{6}$

3. The accompanying diagram shows the results of a survey asking which sports the members of the Key Club watch on television.

Sports Watched on Television

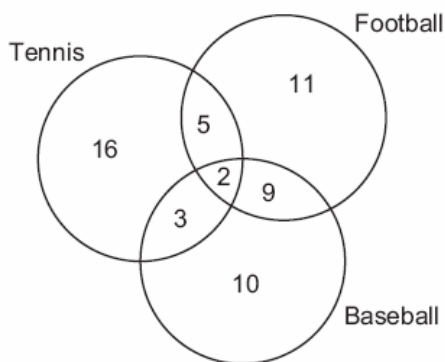

Which statement or statements are true?

- I The most watched sport is tennis.
- II The least watched sport is baseball.
- III More Key Club members watch tennis than football.

[A] I and II, only      [B] II and III, only

[C] II, only      [D] I, only

4. During each marking period, there are five tests. If Vanita needs a 65 average to pass this marking period and her first four grades are 60, 72, 55, and 80, what is the *lowest* score she can earn on the last test to have a passing average?

[A] 65      [B] 100      [C] 58      [D] 80

5. What is the slope of the linear equation  $5y - 10x = -15$ ?

[A] 10      [B] -15      [C] 2      [D] -10

6. Which expression is a factor of  $n^2 + 3n - 54$ ?

[A]  $n^2 + 9$       [B]  $n - 9$

[C]  $n + 9$       [D]  $n + 6$

7. If  $3.85 \times 10^6$  is divided by  $3.85 \times 10^4$ , the result is

[A]  $3.85 \times 10^4$       [B]  $3.85 \times 10^{10}$

[C] 0.01      [D] 1

8. Two triangles are similar. The lengths of the sides of the smaller triangle are 3, 5, and 6, and the length of the longest side of the larger triangle is 18. What is the perimeter of the larger triangle?

[A] 14      [B] 42      [C] 18      [D] 24

9. Which letter has point symmetry?

[A] W      [B] B      [C] H      [D] A

10. If two lines are parallel and the slope of one of the lines is  $m$ , what is the product of their slopes?

[A] 1      [B] 0      [C]  $m^2$       [D]  $2m$

11. Which is an irrational number?

[A] 0      [B]  $\pi$       [C]  $\sqrt{9}$       [D]  $-\frac{1}{3}$

12. If point  $P$  lies on line  $\ell$ , which diagram represents the locus of points 3 centimeters from point  $P$ ?

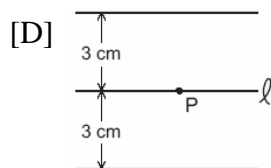
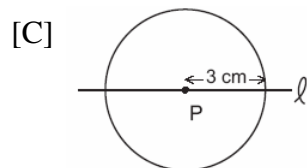
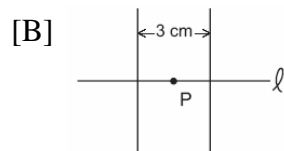
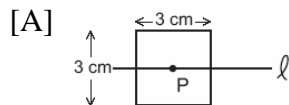

13. What is the measure, in degrees, of each exterior angle of a regular hexagon?

[A] 60      [B] 45      [C] 135      [D] 120

14. What is the solution of the equation  $3y - 5y + 10 = 36$ ?

[A] 4.5      [B] 2      [C] -13      [D] 13

15. If the circumference of a circle is doubled, the diameter of the circle

[A] remains the same      [B] increases by 2  
[C] is doubled      [D] is multiplied by 4

16. In the accompanying diagram,  $\triangle ABC$  is similar to but not congruent to  $\triangle A'B'C'$ . Which transformation is represented by  $\triangle A'B'C'$ ?

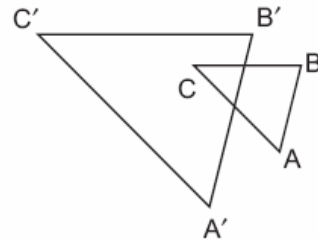

[A] translation      [B] dilation  
[C] reflection      [D] rotation

17. The expression  $15 - 3[2 + 6(-3)]$  simplifies to

[A] -33      [B] 63      [C] -45      [D] 192

18. The expression  $\sqrt{90} \cdot \sqrt{40} - \sqrt{8} \cdot \sqrt{18}$  simplifies to

[A] 3,456      [B] 48      [C] 22.9      [D] 864



19. If  $x = 2a - b^2$ , then  $a$  equals

- [A]  $\frac{b^2 - x}{2}$                       [B]  $x + b^2$   
 [C]  $\frac{x + b^2}{2}$                       [D]  $\frac{x - b^2}{2}$

20. The accompanying diagram is an example of which type of graph?

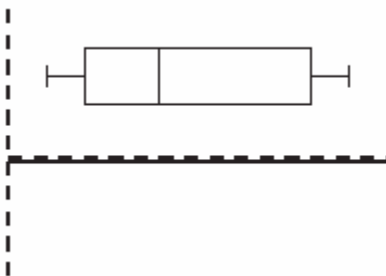

- [A] stem-and-leaf plot              [B] histogram  
 [C] bar graph                      [D] box-and-whisker plot

21. Given the true statement "John is not handsome" and the false statement "John is handsome or smart." Determine the truth value for the statement "John is smart."

22. Ninety percent of the ninth grade students at Richbartville High School take algebra. If 180 ninth grade students take algebra, how many ninth grade students do *not* take algebra?

23. If the instructions for cooking a turkey state "Roast turkey at  $325^\circ$  for 20 minutes per pound," how many hours will it take to roast a 20-pound turkey at  $325^\circ$ ?

24. An addition table for a subset of real numbers is shown below. Which number is the identity element? Explain your answer.

+	0	1	2	3
0	0	1	2	3
1	1	2	3	4
2	2	3	4	0
3	3	4	0	1

25. Write the equation for the line shown in the accompanying graph. Explain your answer.

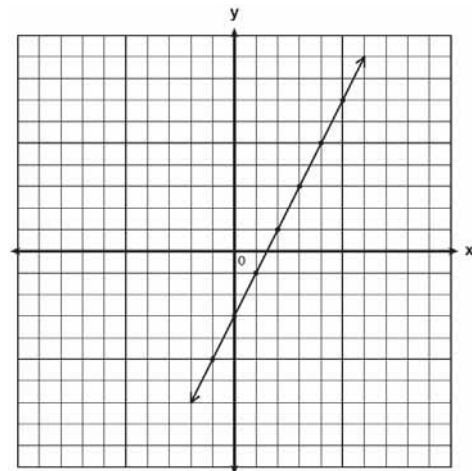

26. Two parallel roads, Elm Street and Oak Street, are crossed by a third, Walnut Street, as shown in the accompanying diagram. Find the number of degrees in the acute angle formed by the intersection of Walnut Street and Elm Street.

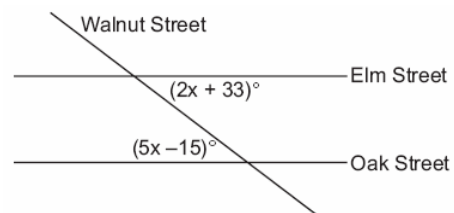

27. The plot of land illustrated in the accompanying diagram has a perimeter of 34 yards. Find the length, in yards, of *each* side of the figure. Could these measures actually represent the measures of the sides of a triangle? Explain your answer.

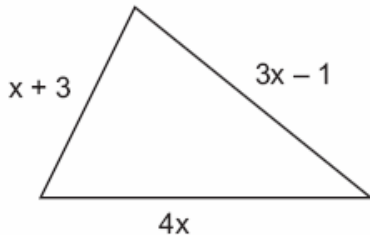

28. As shown in the accompanying diagram, radio station KMA is increasing its radio listening radius from 40 miles to 50 miles. How many additional square miles of listening area, to the *nearest tenth*, will the radio station gain?

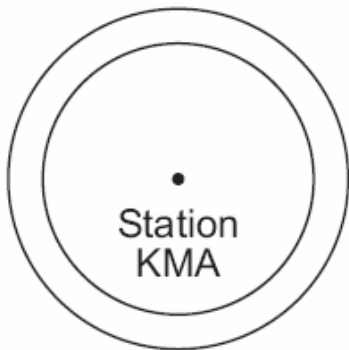

29. Solve for  $x$ :  $x^2 + 3x - 28 = 0$

30. In the accompanying diagram, triangle A is similar to triangle B. Find the value of  $n$ .

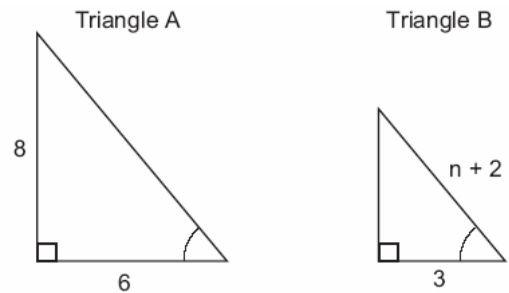

31. As seen in the accompanying diagram, a person can travel from New York City to Buffalo by going north 170 miles to Albany and then west 280 miles to Buffalo.

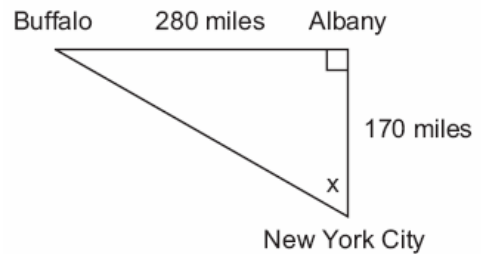

- a* If an engineer wants to design a highway to connect New York City directly to Buffalo, at what angle,  $x$ , would she need to build the highway? Find the angle to the *nearest degree*.
- b* To the *nearest mile*, how many miles would be saved by traveling directly from New York City to Buffalo rather than by traveling first to Albany and then to Buffalo?

32. At Ron's Rental, a person can rent a big-screen television for \$10 a month plus a one-time "wear-and-tear" fee of \$100. At Josie's Rental, the charge is \$20 a month and an additional charge of \$20 for delivery with no "wear-and-tear" fee.
- a If  $c$  equals the cost, write one equation representing the cost of the rental for  $m$  months at Ron's Rental and one equation representing the cost of the rental for  $m$  months at Josie's Rental.
- b On the accompanying grid, graph and label each equation.
- c From your graph, determine in which month Josie's cost will equal Ron's cost.

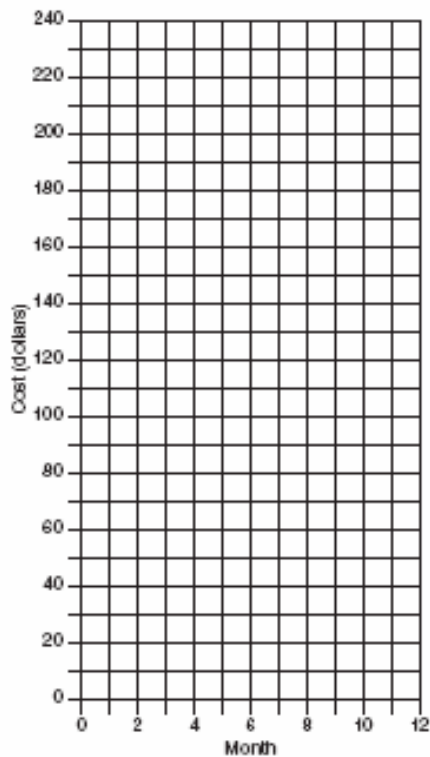

33. Mr. Perez owns a sneaker store. He bought 350 pairs of basketball sneakers and 150 pairs of soccer sneakers from the manufacturers for \$62,500. He sold all the sneakers and made a 25% profit. If he sold the soccer sneakers for \$130 per pair, how much did he charge for one pair of basketball sneakers?

34. Alexi's wallet contains four \$1 bills, three \$5 bills, and one \$10 bill. If Alexi randomly removes two bills without replacement, determine whether the probability that the bills will total \$15 is greater than the probability that the bills will total \$2.
35. A rocket is launched from the ground and follows a parabolic path represented by the equation  $y = -x^2 + 10x$ . At the same time, a flare is launched from a height of 10 feet and follows a straight path represented by the equation  $y = -x + 10$ . Using the accompanying set of axes, graph the equations that represent the paths of the rocket and the flare, and find the coordinates of the point or points where the paths intersect.

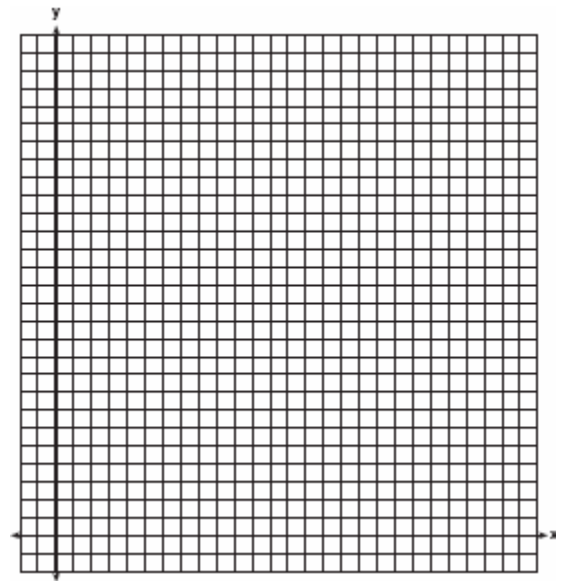

1. On a map, 1 centimeter represents 40 kilometers. How many kilometers are represented by 8 centimeters?  
[A] 48 [B] 280 [C] 320 [D] 5

2. In the accompanying diagram of parallelogram  $ABCD$ , diagonals  $\overline{AC}$  and  $\overline{DB}$  intersect at  $E$ ,  $AE = 3x - 4$ , and  $EC = x + 12$ .

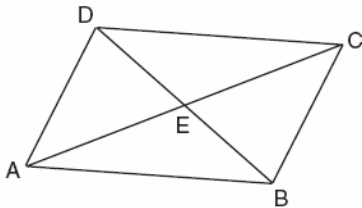

What is the value of  $x$ ?

- [A] 20 [B] 8 [C] 16 [D] 40
3. What is the total number of points equidistant from two intersecting straight roads and also 300 feet from the traffic light at the center of the intersection?  
[A] 2 [B] 0 [C] 1 [D] 4
4. Juan has three blue shirts, two green shirts, seven red shirts, five pairs of denim pants, and two pairs of khaki pants. How many different outfits consisting of one shirt and one pair of pants are possible?  
[A] 19 [B] 420 [C] 130 [D] 84

5. Given the statement: "If two lines are cut by a transversal so that the corresponding angles are congruent, then the lines are parallel." What is true about the statement and its converse?

- [A] The statement and its converse are both false.  
[B] The statement is true, but its converse is false.  
[C] The statement and its converse are both true.  
[D] The statement is false, but its converse is true.

6. If the area of a square garden is 48 square feet, what is the length, in feet, of one side of the garden?

- [A]  $4\sqrt{3}$  [B]  $4\sqrt{6}$   
[C]  $12\sqrt{2}$  [D]  $16\sqrt{3}$

7. The sum of  $\frac{3}{x} + \frac{2}{5}$ ,  $x \neq 0$ , is

- [A]  $\frac{1}{x}$  [B]  $\frac{2x+15}{x+5}$   
[C]  $\frac{5}{x+5}$  [D]  $\frac{2x+15}{5x}$

8. The number  $0.14114111411114\dots$  is

- [A] rational [B] integral  
[C] whole [D] irrational

9. When  $-2x^2 + 4x + 2$  is subtracted from  $x^2 + 6x - 4$ , the result is
- [A]  $3x^2 + 2x - 6$       [B]  $-3x^2 - 2x + 6$   
 [C]  $2x^2 - 2x - 6$       [D]  $-x^2 + 10x - 2$
10. If  $0.0347$  is written by a scientist in the form  $3.47 \times 10^n$ , the value of  $n$  is
- [A] -3      [B] 2      [C] 3      [D] -2
11. If  $x = -2$  and  $y = -1$ , which point on the accompanying set of axes represents the translation  $(x, y) \rightarrow (x + 2, y - 3)$ ?

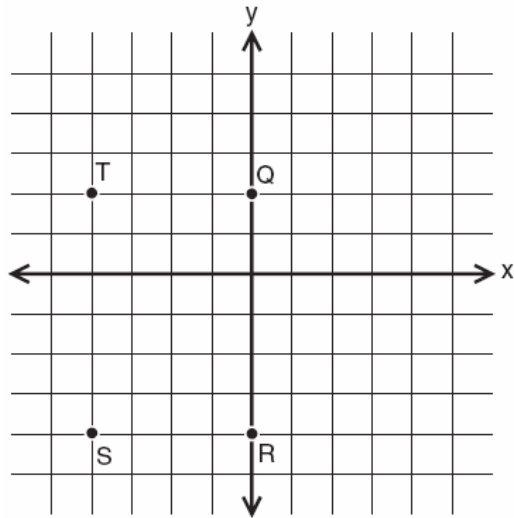

- [A] Q      [B] S      [C] R      [D] T

12. In the accompanying diagram, which transformation changes the solid-line parabola to the dotted-line parabola?

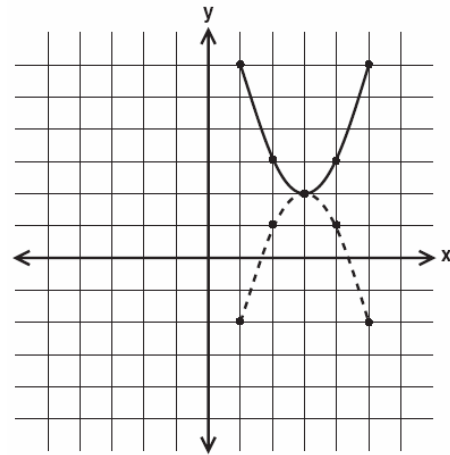

- [A] line reflection or rotation  
 [B] rotation, only  
 [C] line reflection, only      [D] translation

13. How many times larger than  $\frac{1}{4}x$  is  $5x$ ?

- [A]  $\frac{5}{4}$       [B] 20      [C] 9      [D]  $\frac{4}{5}$

14. If the lengths of two sides of a triangle are 4 and 10, what could be the length of the third side?

- [A] 16      [B] 14      [C] 8      [D] 6

15. Which piece of paper can be folded into a pyramid?

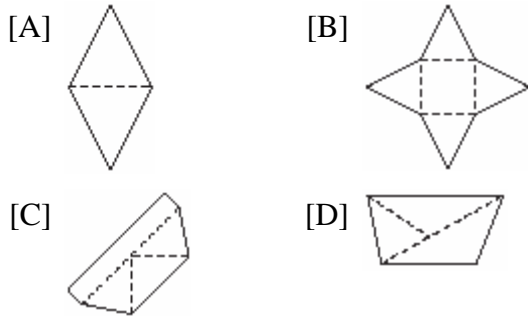

16. What is the measure of the largest angle in the accompanying triangle?

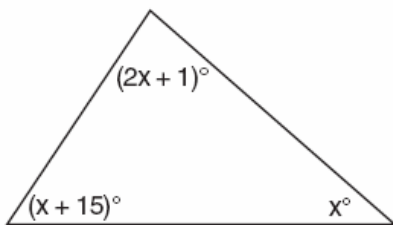

- [A] 56 [B] 46.5 [C] 83 [D] 41

17.  $M$  is the midpoint of  $\overline{AB}$ . If the coordinates of  $A$  are  $(-1,5)$  and the coordinates of  $M$  are  $(3,3)$ , what are the coordinates of  $B$ ?

- [A]  $(2,8)$  [B]  $(7,1)$   
[C]  $(-5,7)$  [D]  $(1,4)$

18. If  $2m + 2p = 16$ ,  $p$  equals

- [A]  $16 + 2m$  [B]  $16 - m$   
[C]  $9m$  [D]  $8 - m$

19. If  $2x + 5 = -25$  and  $-3m - 6 = 48$ , what is the product of  $x$  and  $m$ ?

- [A] 270 [B] -270 [C] 3 [D] -33

20. In the graph of  $y \leq -x$ , which quadrant is completely shaded?

- [A] IV [B] I [C] III [D] II

21. In the accompanying diagram of  $\triangle BCD$ ,  $\triangle ABC$  is an equilateral triangle and  $AD = AB$ . What is the value of  $x$ , in degrees?

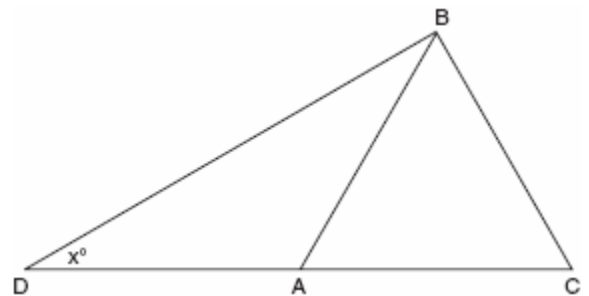

22. In the addition table for a subset of real numbers shown below, which number is the inverse of 3? Explain your answer.

$\oplus$	1	2	3	4
1	2	3	4	1
2	3	4	1	2
3	4	1	2	3
4	1	2	3	4

23. An image of a building in a photograph is 6 centimeters wide and 11 centimeters tall. If the image is similar to the actual building and the actual building is 174 meters wide, how tall is the actual building, in meters?
24. A doughnut shop charges \$0.70 for each doughnut and \$0.30 for a carryout box. Shirley has \$5.00 to spend. At most, how many doughnuts can she buy if she also wants them in one carryout box?
25. In bowling leagues, some players are awarded extra points called their "handicap." The "handicap" in Anthony's league is 80% of the difference between 200 and the bowler's average. Anthony's average is 145. What is Anthony's "handicap"?
26. In a telephone survey of 100 households, 32 households purchased Brand A cereal and 45 purchased Brand B cereal. If 10 households purchased both items, how many of the households surveyed did *not* purchase either Brand A or Brand B cereal?
27. Tamika could not remember her scores from five mathematics tests. She did remember that the mean (average) was exactly 80, the median was 81, and the mode was 88. If all her scores were integers with 100 the highest score possible and 0 the lowest score possible, what was the *lowest* score she could have received on any one test?

28. There are 28 students in a mathematics class. If  $\frac{1}{4}$  of the students are called to the guidance office,  $\frac{1}{3}$  of the remaining students are called to the nurse, and, finally,  $\frac{1}{2}$  of those left go to the library, how many students remain in the classroom?
29. On a bookshelf, there are five different mystery books and six different biographies. How many different sets of four books can Emilio choose if two of the books must be mystery books and two of the books must be biographies?
30. On the accompanying grid, graph a circle whose center is at (0,0) and whose radius is 5. Determine if the point (5,-2) lies on the circle.

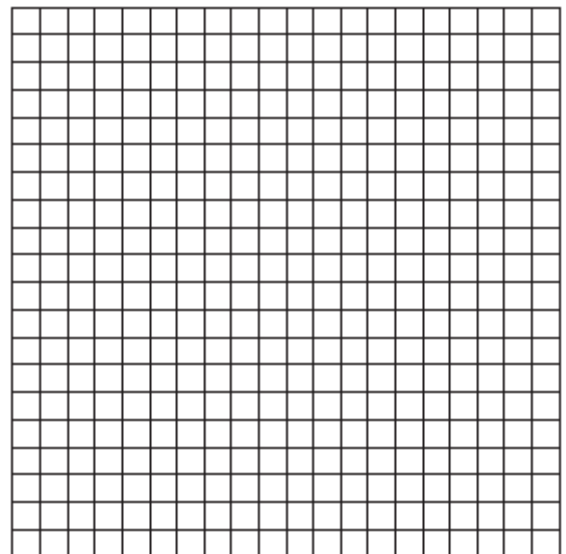

31. In the accompanying diagram,  $x$  represents the length of a ladder that is leaning against a wall of a building, and  $y$  represents the distance from the foot of the ladder to the base of the wall. The ladder makes a  $60^\circ$  angle with the ground and reaches a point on the wall 17 feet above the ground. Find the number of feet in  $x$  and  $y$ .

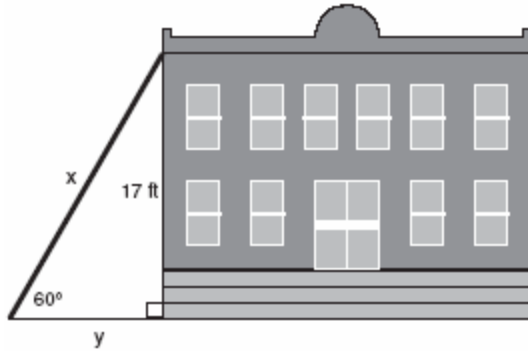

32. A rectangular park is three blocks longer than it is wide. The area of the park is 40 square blocks. If  $w$  represents the width, write an equation in terms of  $w$  for the area of the park. Find the length and the width of the park.
33. Tanisha and Rachel had lunch at the mall. Tanisha ordered three slices of pizza and two colas. Rachel ordered two slices of pizza and three colas. Tanisha's bill was \$6.00, and Rachel's bill was \$5.25. What was the price of one slice of pizza? What was the price of one cola?

34. Greg is in a car at the top of a roller-coaster ride. The distance,  $d$ , of the car from the ground as the car descends is determined by the equation  $d = 144 - 16t^2$ , where  $t$  is the number of seconds it takes the car to travel down to each point on the ride. How many seconds will it take Greg to reach the ground? For an algebraic solution show your work here.  
For a graphic solution show your work here.

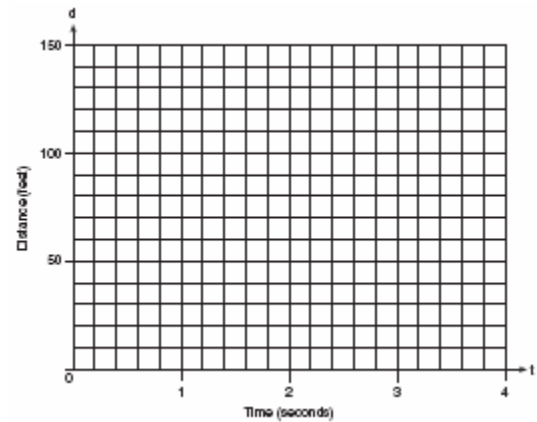

35. Determine the distance between point  $A(-1,-3)$  and point  $B(5,5)$ . Write an equation of the perpendicular bisector of  $\overline{AB}$ . [The use of the accompanying grid is optional.]

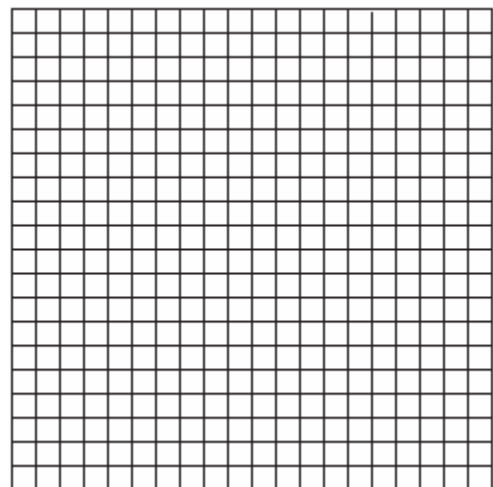



1. The accompanying diagram shows a box-and-whisker plot of student test scores on last year's Mathematics A midterm examination.

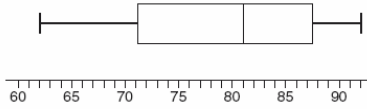

What is the median score?

- [A] 71    [B] 81    [C] 92    [D] 62

2. Triangle  $A'B'C'$  is the image of  $\triangle ABC$  under a dilation such that  $A'B' = 3AB$ . Triangles  $ABC$  and  $A'B'C'$  are

- [A] neither congruent nor similar  
[B] similar but not congruent  
[C] both congruent and similar  
[D] congruent but not similar

3. What is the inverse of the statement "If Mike did his homework, then he will pass this test"?

- [A] If Mike does not pass this test, then he only did half his homework.  
[B] If Mike passes this test, then he did his homework.  
[C] If Mike did not do his homework, then he will not pass this test.  
[D] If Mike does not pass this test, then he did not do his homework.

4. In which list are the numbers in order from least to greatest?

- [A]  $\sqrt{3}$ ,  $\pi$ ,  $3.2$ ,  $3\frac{1}{3}$   
[B]  $\sqrt{3}$ ,  $3.2$ ,  $\pi$ ,  $3\frac{1}{3}$   
[C]  $3.2$ ,  $3\frac{1}{3}$ ,  $\sqrt{3}$ ,  $\pi$   
[D]  $3.2$ ,  $\pi$ ,  $3\frac{1}{3}$ ,  $\sqrt{3}$

5. The accompanying diagram shows a transformation.

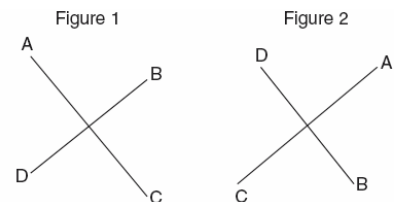

Which transformation performed on figure 1 resulted in figure 2?

- [A] reflection            [B] dilation  
[C] rotation            [D] translation

6. The product of  $3x^5$  and  $2x^4$  is

- [A]  $6x^9$                     [B]  $6x^{20}$   
[C]  $5x^9$                     [D]  $5x^{20}$

7. There are 12 people on a basketball team, and the coach needs to choose 5 to put into a game. How many different possible ways can the coach choose a team of 5 if each person has an equal chance of being selected?

- [A]  ${}_{12}P_5$                     [B]  ${}_5C_{12}$   
[C]  ${}_{12}C_5$                     [D]  ${}_5P_{12}$

8. Given the true statement: "If a person is eligible to vote, then that person is a citizen."  
Which statement must also be true?
- [A] Juan is a citizen; therefore, he is eligible to vote.
- [B] Morgan has never voted; therefore, he is not a citizen.
- [C] Kayla is not a citizen; therefore, she is not eligible to vote.
- [D] Marie is not eligible to vote; therefore, she is not a citizen.

9. Line  $P$  and line  $C$  lie on a coordinate plane and have equal slopes. Neither line crosses the second or third quadrant. Lines  $P$  and  $C$  must
- [A] be perpendicular
- [B] be horizontal [C] be vertical
- [D] form an angle of  $45^\circ$

10. The equation  $P = 2L + 2W$  is equivalent to
- [A]  $L = \frac{P+2W}{2}$  [B]  $L = \frac{P-2W}{2}$
- [C]  $2L = \frac{P}{2W}$  [D]  $L = P - W$

11. The sum of  $\sqrt{75}$  and  $\sqrt{3}$  is
- [A] 18 [B]  $6\sqrt{3}$  [C]  $\sqrt{78}$  [D] 15

12. Which graph represents the solution set for  $2x - 4 \leq 8$  and  $x + 5 \geq 7$ ?

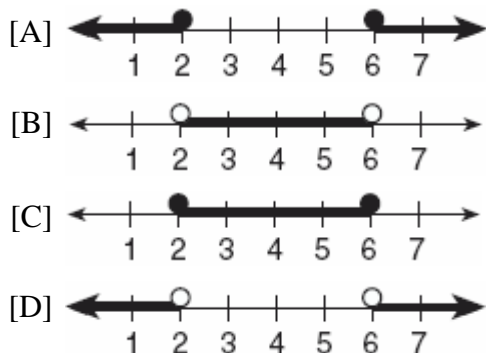

13. If the measure of an angle is represented by  $2x$ , which expression represents the measure of its complement?

[A]  $90 - 2x$  [B]  $88x$   
[C]  $180 - 2x$  [D]  $90 + 2x$

14. Which equation illustrates the multiplicative identity element?

[A]  $x - x = 0$  [B]  $x \cdot \frac{1}{x} = 1$   
[C]  $x + 0 = x$  [D]  $x \cdot 1 = x$

15. The ages of five children in a family are 3, 3, 5, 8, and 18. Which statement is true for this group of data?

[A] mode  $>$  mean [B] median = mode  
[C] median  $>$  mean  
[D] mean  $>$  median

16. In the accompanying diagram of right triangle  $ABC$ ,  $AB = 8$ ,  $BC = 15$ ,  $AC = 17$ , and  $m\angle ABC = 90$ .

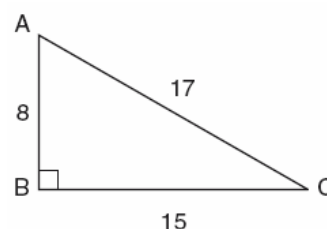

What is  $\tan \angle C$ ?

[A]  $\frac{8}{15}$  [B]  $\frac{8}{17}$  [C]  $\frac{15}{17}$  [D]  $\frac{17}{15}$

17. The locus of points equidistant from two sides of an acute scalene triangle is

[A] an angle bisector [B] a median  
[C] an altitude [D] the third side

18. What are the factors of  $x^2 - 10x - 24$  ?  
 [A]  $(x - 12)(x + 2)$     [B]  $(x - 4)(x + 6)$   
 [C]  $(x + 12)(x - 2)$     [D]  $(x - 4)(x - 6)$
19. What is the value of  $\frac{6.3 \times 10^8}{3 \times 10^4}$  in scientific notation?  
 [A]  $2.1 \times 10^2$                       [B]  $2.1 \times 10^4$   
 [C]  $2.1 \times 10^{-4}$                       [D]  $2.1 \times 10^{-2}$
20. In the accompanying figure, what is one pair of alternate interior angles?

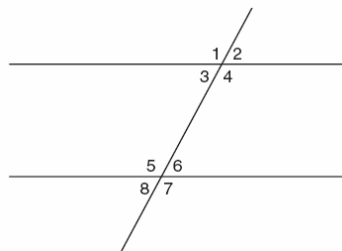

- [A]  $\angle 6$  and  $\angle 8$                       [B]  $\angle 1$  and  $\angle 2$   
 [C]  $\angle 4$  and  $\angle 5$                       [D]  $\angle 4$  and  $\angle 6$
21. If Laquisha can enter school by any one of three doors and the school has two staircases to the second floor, in how many different ways can Laquisha reach a room on the second floor? Justify your answer by drawing a tree diagram or listing a sample space.
22. The world population was 4.2 billion people in 1982. The population in 1999 reached 6 billion. Find the percent of change from 1982 to 1999.
23. Six members of a school's varsity tennis team will march in a parade. How many different ways can the players be lined up if Angela, the team captain, is always at the front of the line?

24. A fish tank with a rectangular base has a volume of 3,360 cubic inches. The length and width of the tank are 14 inches and 12 inches, respectively. Find the height, in inches, of the tank.
25. Mr. Smith's class voted on their favorite ice cream flavors, and the results are shown in the accompanying diagram. If there are 20 students in Mr. Smith's class, how many students chose coffee ice cream as their favorite flavor?

Favorite Ice Cream Flavors

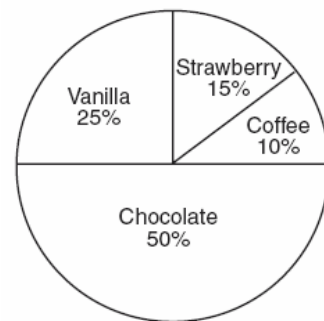

26. Three brothers have ages that are consecutive even integers. The product of the first and third boys' ages is 20 more than twice the second boy's age. Find the age of *each* of the three boys.
27. Arielle has a collection of grasshoppers and crickets. She has 561 insects in all. The number of grasshoppers is twice the number of crickets. Find the number of *each* type of insect that she has.

28. The graph of a quadratic equation is shown in the accompanying diagram. The scale on the axes is a unit scale. Write an equation of this graph in standard form.

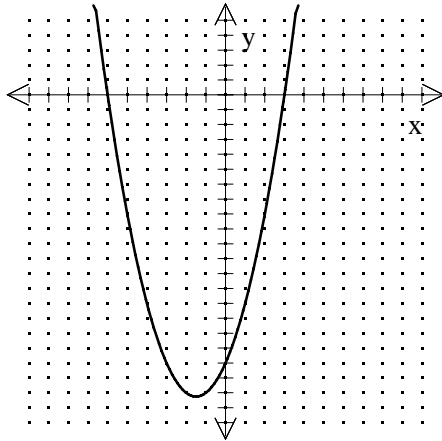

29. Currently, Tyrone has \$60 and his sister has \$135. Both get an allowance of \$5 each week. Tyrone decides to save his entire allowance, but his sister spends all of hers each week plus an additional \$10 each week. After how many weeks will they each have the same amount of money?  
[The use of the grid is optional.]

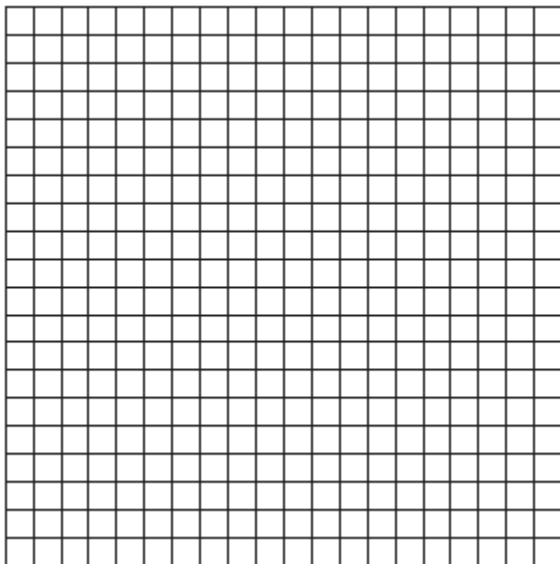

30. A rectangular garden is going to be planted in a person's rectangular backyard, as shown in the accompanying diagram. Some dimensions of the backyard and the width of the garden are given. Find the area of the garden to the nearest square foot.

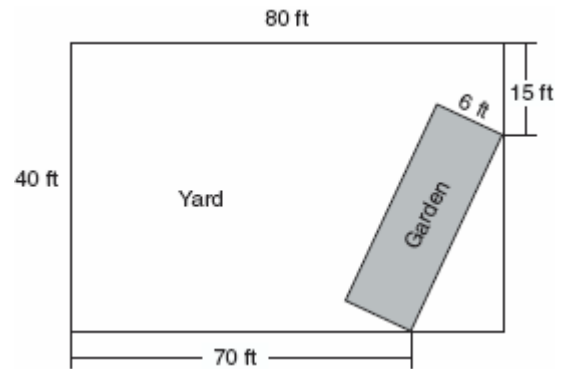

31. At the Phoenix Surfboard Company, \$306,000 in profits was made last year. This profit was shared by the four partners in the ratio 3:3:5:7. How much *more* money did the partner with the largest share make than one of the partners with the smallest share?
32. Alexandra purchases two doughnuts and three cookies at a doughnut shop and is charged \$3.30. Briana purchases five doughnuts and two cookies at the same shop for \$4.95. All the doughnuts have the same price and all the cookies have the same price. Find the cost of one doughnut and find the cost of one cookie.

33. On the accompanying grid, draw and label quadrilateral  $ABCD$  with points  $A(1,2)$ ,  $B(6,1)$ ,  $C(7,6)$ , and  $D(3,7)$ . On the same set of axes, plot and label quadrilateral  $A'B'C'D'$ , the reflection of quadrilateral  $ABCD$  in the  $y$ -axis. Determine the area, in square units, of quadrilateral  $A'B'C'D'$ .

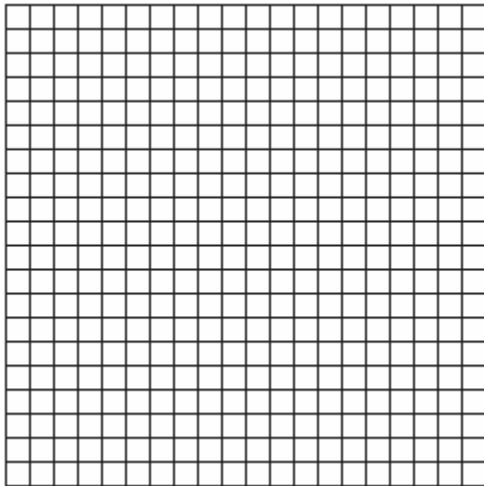

34. Sarah's mathematics grades for one marking period were 85, 72, 97, 81, 77, 93, 100, 75, 86, 70, 96, and 80.
- a. Complete the tally sheet and frequency table below, and construct and label a frequency histogram for Sarah's grades using the accompanying grid.

Interval (grades)	Tally	Frequency
61–70		
71–80		
81–90		
91–100		

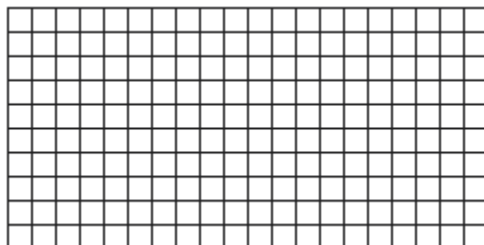

- b. Which interval contains the 75th percentile (upper quartile)?

35. On the accompanying set of axes, graph and label the following lines:

$$y = 5$$

$$x = -4$$

$$y = \frac{5}{4}x + 5$$

Calculate the area, in square units, of the triangle formed by the three points of intersection.

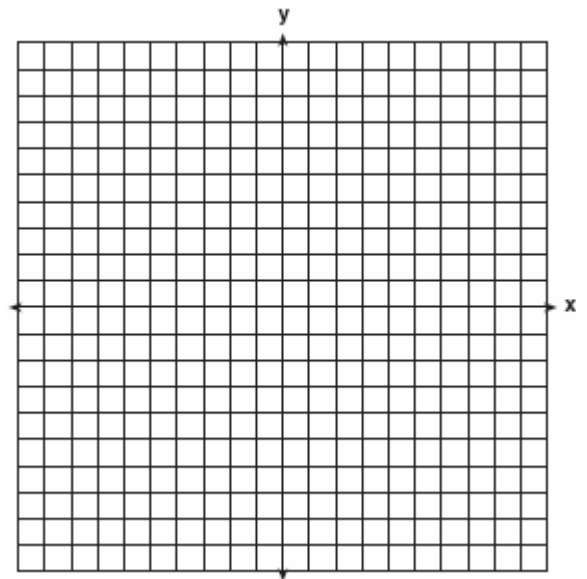

1. The number  $8.375 \times 10^{-3}$  is equivalent to  
[A] 8,375                      [B] 0.0008375  
[C] 0.08375                  [D] 0.008375

2. The accompanying diagram shows a square with side  $y$  inside a square with side  $x$ .

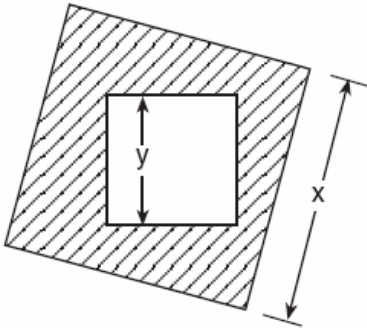

Which expression represents the area of the shaded region?

- [A]  $y^2 - x^2$                   [B]  $x^2 - y^2$   
[C]  $y^2$                           [D]  $x^2$
3. Which expression represents an irrational number?  
[A] 0    [B]  $\frac{1}{2}$     [C]  $\sqrt{2}$     [D] 0.17
4. Which shape does *not* have rotational symmetry?  
[A] trapezoid                  [B] square  
[C] regular pentagon        [D] circle

5. Bob and Laquisha have volunteered to serve on the Junior Prom Committee. The names of twenty volunteers, including Bob and Laquisha, are put into a bowl. If two names are randomly drawn from the bowl without replacement, what is the probability that Bob's name will be drawn first and Laquisha's name will be drawn second?

- [A]  $\frac{2}{20}$                           [B]  $\frac{2}{20!}$   
[C]  $\frac{1}{20} \cdot \frac{1}{20}$                   [D]  $\frac{1}{20} \cdot \frac{1}{19}$

6. Tori computes the value of  $8 \times 95$  in her head by thinking  $8(100 - 5) = 8 \times 100 - 8 \times 5$ . Which number property is she using?

- [A] associative                  [B] commutative  
[C] closure                      [D] distributive

7. A triangle has sides whose lengths are 5, 12, and 13. A similar triangle could have sides with lengths of

- [A] 10, 24, and 26              [B] 3, 4, and 15  
[C] 7, 24, and 25                [D] 6, 8, and 10

8. Which statement is logically equivalent to "If it is Saturday, then I am not in school"?

- [A] If it is Saturday, then I am in school.  
[B] If I am not in school, then it is Saturday.  
[C] If I am in school, then it is not Saturday.  
[D] If it is not Saturday, then I am in school.

9. A translation moves  $P(3,5)$  to  $P'(6,1)$ . What are the coordinates of the image of point  $(-3,-5)$  under the same translation?
- [A] (0,-9)                      [B] (-6,-9)  
[C] (-6,-1)                    [D] (-5,-3)
10. If  $x + y = 9x + y$ , then  $x$  is equal to
- [A]  $\frac{1}{5}y$     [B]  $y$     [C] 0    [D] 8
11. Which number is in the solution set of the inequality  $5x + 3 > 38$ ?
- [A] 8    [B] 5    [C] 7    [D] 6
12. The expression  $3^2 \cdot 3^3 \cdot 3^4$  is equivalent to
- [A]  $27^{24}$     [B]  $3^9$     [C]  $3^{24}$     [D]  $27^9$
13. What is the solution set of the equation  $x^2 - 5x - 24 = 0$ ?
- [A] {3,-8}                      [B] {-3,8}  
[C] {-3,-8}                    [D] {3,8}
14. If the expression  $3 - 4^2 + \frac{6}{2}$  is evaluated, what would be done *last*?
- [A] dividing                      [B] adding  
[C] squaring                      [D] subtracting
15. What is the additive inverse of  $\frac{2}{3}$ ?
- [A]  $-\frac{3}{2}$     [B]  $-\frac{2}{3}$     [C]  $\frac{3}{2}$     [D]  $\frac{1}{3}$
16. The sum of  $\sqrt{18}$  and  $\sqrt{72}$  is
- [A]  $6\sqrt{3}$                       [B]  $\sqrt{90}$   
[C]  $9\sqrt{2}$                       [D]  $3\sqrt{10}$
17. What is the inverse of the statement "If Julie works hard, then she succeeds"?
- [A] If Julie does not work hard, then she does not succeed.  
[B] If Julie works hard, then she does not succeed.  
[C] If Julie does not succeed, then she does not work hard.  
[D] If Julie succeeds, then she works hard.
18. If one factor of  $56x^4y^3 - 42x^2y^6$  is  $14x^2y^3$ , what is the other factor?
- [A]  $4x^2y - 3xy^3$               [B]  $4x^2 - 3y^2$   
[C]  $4x^2y - 3xy^2$               [D]  $4x^2 - 3y^3$
19. For which value of  $x$  is the expression  $\frac{3x-6}{x-4}$  undefined?
- [A] 4    [B] 2    [C] 0    [D] -4

20. How many different five-member teams can be made from a group of eight students, if each student has an equal chance of being chosen?

[A] 40 [B] 6,720 [C] 336 [D] 56

21. The student scores on Mrs. Frederick's mathematics test are shown on the stem-and-leaf plot below.



Find the median of these scores.

22. The lengths of the sides of two similar rectangular billboards are in the ratio 5:4. If 250 square feet of material is needed to cover the larger billboard, how much material, in square feet, is needed to cover the smaller billboard?

23. Solve for  $m$ :  $0.6m + 3 = 2m + 0.2$

24. In the accompanying diagram, line  $m$  is parallel to line  $p$ , line  $t$  is a transversal,  $m\angle a = 3x + 12$ , and  $m\angle b = 2x + 13$ . Find the value of  $x$ .

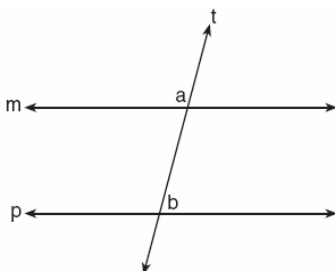

25. On the accompanying diagram of  $\triangle ABC$ , use a compass and a straightedge to construct a median from  $A$  to  $\overline{BC}$ .

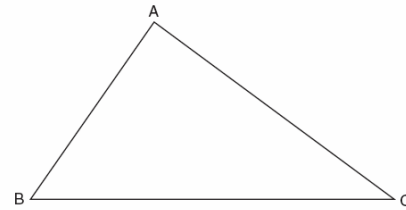

26. Seth has one less than twice the number of compact discs (CDs) that Jason has. Raoul has 53 more CDs than Jason has. If Seth gives Jason 25 CDs, Seth and Jason will have the same number of CDs. How many CDs did *each* of the three boys have to begin with?

27. Tina's preschool has a set of cardboard building blocks, each of which measures 9 inches by 9 inches by 4 inches. How many of these blocks will Tina need to build a wall 4 inches thick, 3 feet high, and 12 feet long?

28. In a town election, candidates  $A$  and  $B$  were running for mayor. There were 30,500 people

eligible to vote, and  $\frac{3}{4}$  of them actually

voted. Candidate  $B$  received  $\frac{1}{3}$  of the votes

cast. How many people voted for candidate  $B$ ? What percent of the votes cast, to the nearest tenth of a percent, did candidate  $A$  receive?



29. A certain state is considering changing the arrangement of letters and numbers on its license plates. The two options the state is considering are:
- Option 1: three letters followed by a four-digit number with repetition of both letters and digits allowed
- Option 2: four letters followed by a three-digit number without repetition of either letters or digits
- [Zero may be chosen as the first digit of the number in either option.]
- Which option will enable the state to issue more license plates? How many *more* different license plates will that option yield?

30. To get from his high school to his home, Jamal travels 5.0 miles east and then 4.0 miles north. When Sheila goes to her home from the same high school, she travels 8.0 miles east and 2.0 miles south. What is the measure of the shortest distance, to the *nearest tenth of a mile*, between Jamal's home and Sheila's home? [The use of the accompanying grid is optional.]

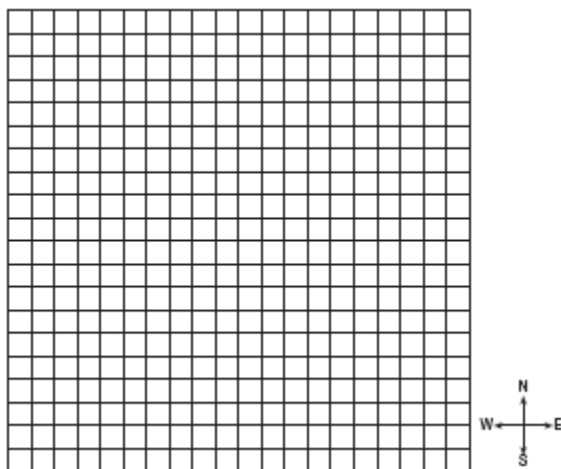

31. Deborah built a box by cutting 3-inch squares from the corners of a rectangular sheet of cardboard, as shown in the accompanying diagram, and then folding the sides up. The volume of the box is 150 cubic inches, and the longer side of the box is 5 inches more than the shorter side. Find the number of inches in the shorter side of the *original* sheet of cardboard.

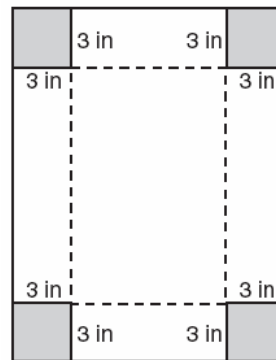

32. A triangular park is formed by the intersection of three streets, Bridge Street, Harbor Place, and College Avenue, as shown in the accompanying diagram. A walkway parallel to Harbor Place goes through the park. A time capsule has been buried in the park in a location that is equidistant from Bridge Street and College Avenue and 5 yards from the walkway. Indicate on the diagram with an **X** *each* possible location where the time capsule could be buried.

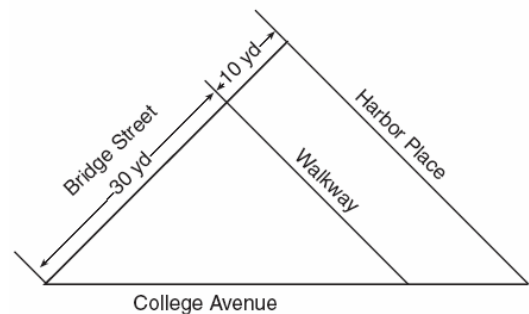

33. An architect is designing a museum entranceway in the shape of a parabolic arch represented by the equation  $y = -x^2 + 20x$ , where  $0 \leq x \leq 20$  and all dimensions are expressed in feet. On the accompanying set of axes, sketch a graph of the arch and determine its maximum height, in feet.

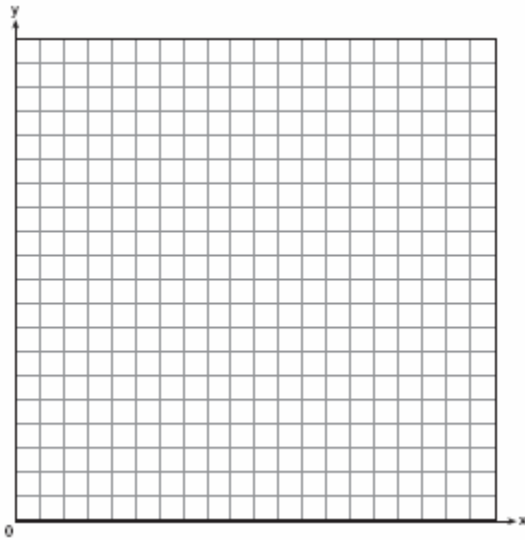

34. A straw is placed into a rectangular box that is 3 inches by 4 inches by 8 inches, as shown in the accompanying diagram. If the straw fits exactly into the box diagonally from the bottom left front corner to the top right back corner, how long is the straw, to the nearest tenth of an inch?

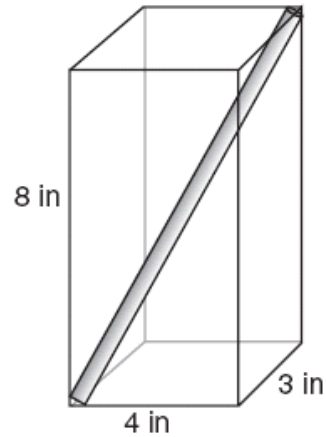

35. The senior class is sponsoring a dance. The cost of a student disk jockey is \$40, and tickets sell for \$2 each. Write a linear equation and, on the accompanying grid, graph the equation to represent the relationship between the number of tickets sold and the profit from the dance. Then find how many tickets must be sold to break even.

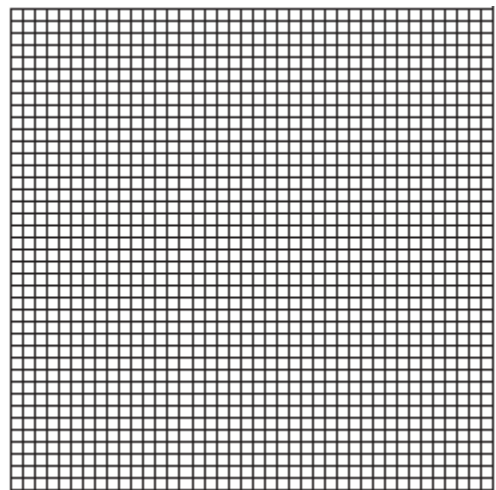

- If  $2(x + 3) = x + 10$ , then  $x$  equals  
[A] 4 [B] 5 [C] 7 [D] 14
- In the accompanying diagram, parallel lines  $\overline{AB}$  and  $\overline{CD}$  are intersected by transversal  $\overline{EF}$  at points  $G$  and  $H$ , respectively,  $m\angle AGH = x + 15$ , and  $m\angle GHD = 2x$ .

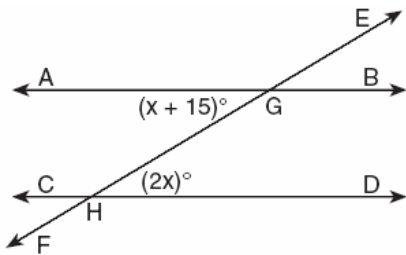

Which equation can be used to find the value of  $x$ ?

- [A]  $2x + x + 15 = 180$   
[B]  $2x + x + 15 = 90$   
[C]  $2x(x + 15) = 0$  [D]  $2x = x + 15$
- On February 18, from 9 a.m. until 2 p.m., the temperature rose from  $-14^\circ\text{F}$  to  $36^\circ\text{F}$ . What was the total increase in temperature during this time period?  
[A]  $50^\circ$  [B]  $32^\circ$  [C]  $36^\circ$  [D]  $22^\circ$
  - Which statement about quadrilaterals is true?  
[A] All quadrilaterals have four sides.  
[B] All quadrilaterals are parallelograms.  
[C] All quadrilaterals have equal sides.  
[D] All quadrilaterals have four right angles.
  - In a school building, there are 10 doors that can be used to enter the building and 8 stairways to the second floor. How many different routes are there from outside the building to a class on the second floor?  
[A] 1 [B] 10 [C] 18 [D] 80

- What is the value of  $\frac{x^2 - 4y}{2}$ , if  $x = 4$  and  $y = -3$ ?  
[A] 14 [B] 2 [C] 10 [D] -2
- Given the true statements: "Jason goes shopping or he goes to the movies" and "Jason does not go to the movies." Which statement must also be true?  
[A] Jason goes shopping.  
[B] Jason does not go shopping.  
[C] Jason stays home.  
[D] Jason does not go shopping and he does not go to the movies.

- An equation of the line that has a slope of 3 and a  $y$ -intercept of -2 is

- [A]  $y = 3x - 2$  [B]  $x = 3y - 2$   
[C]  $y = -2x + 3$  [D]  $y = -x$

- In the accompanying diagram, line  $\ell_1$  is parallel to line  $\ell_2$ .

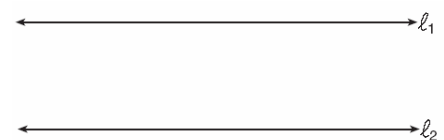

Which term describes the locus of all points that are equidistant from line  $\ell_1$  and  $\ell_2$ ?

- [A] point [B] circle  
[C] line [D] rectangle

10. The accompanying diagram shows two similar triangles.

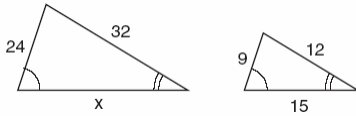

Which proportion could be used to solve for  $x$ ?

- [A]  $\frac{x}{24} = \frac{9}{15}$       [B]  $\frac{32}{12} = \frac{15}{x}$   
 [C]  $\frac{24}{9} = \frac{15}{x}$       [D]  $\frac{32}{x} = \frac{12}{15}$

11. Which graph is symmetric with respect to the  $y$ -axis?

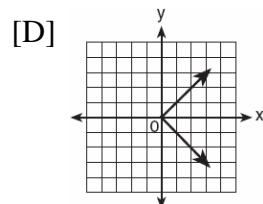
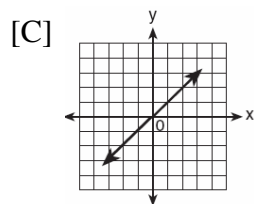
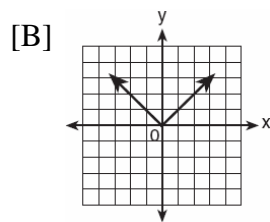
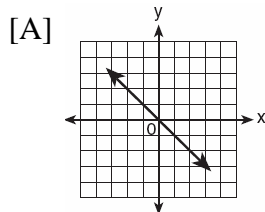

12. John left his home and walked 3 blocks to his school, as shown in the accompanying graph.

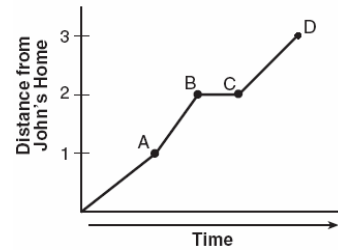

What is one possible interpretation of the section of the graph from point  $B$  to point  $C$ ?

- [A] John reached the top of a hill and began walking on level ground.  
 [B] John waited before crossing a busy street.  
 [C] John arrived at school and stayed throughout the day.  
 [D] John returned home to get his mathematics homework.
13. The expression  $8^{-4} \cdot 8^6$  is equivalent to  
 [A]  $8^{10}$     [B]  $8^{-2}$     [C]  $8^2$     [D]  $8^{-24}$
14. What is a common factor of  $x^2 - 9$  and  $x^2 - 5x + 6$ ?  
 [A]  $x - 2$       [B]  $x^2$   
 [C]  $x - 3$       [D]  $x + 3$
15. Which statement is the converse of "If the sum of two angles is  $180^\circ$ , then the angles are supplementary"?
- [A] If the sum of two angles is not  $180^\circ$ , then the angles are not supplementary.  
 [B] If the sum of two angles is not  $180^\circ$ , then the angles are supplementary.  
 [C] If two angles are supplementary, then their sum is  $180^\circ$ .  
 [D] If two angles are not supplementary, then their sum is not  $180^\circ$ .

16. Which number is irrational?

- [A] 0.3333 [B]  $\frac{2}{3}$  [C]  $\sqrt{8}$  [D]  $\sqrt{9}$

17. Triangle  $ABC$  represents a metal flag on pole  $AD$ , as shown in the accompanying diagram. On a windy day the triangle spins around the pole so fast that it looks like a three-dimensional shape.

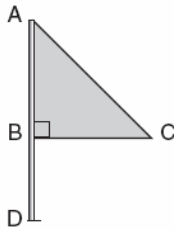

Which shape would the spinning flag create?

- [A] pyramid  
[B] right circular cylinder  
[C] cone [D] sphere

18. In the accompanying graph, if point  $P$  has coordinates  $(a,b)$ , which point has coordinates  $(-b,a)$ ?

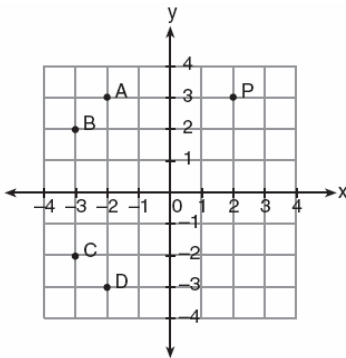

- [A] A [B] D [C] C [D] B

19. What is the solution set of the equation  $3x^2 - 34x - 24 = 0$ ?

- [A]  $\{-2, 6\}$  [B]  $\{-\frac{2}{3}, 12\}$   
[C]  $\{-6, 2\}$  [D]  $\{-12, \frac{2}{3}\}$

20. In the accompanying diagram of a construction, what does  $\overline{PC}$  represent?

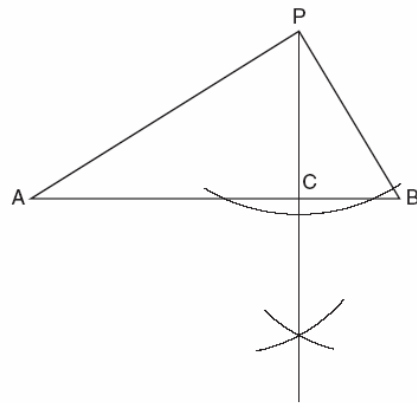

- [A] the perpendicular bisector of  $\overline{AB}$   
[B] a median drawn to  $\overline{AB}$   
[C] the bisector of  $\angle APB$   
[D] an altitude drawn to  $\overline{AB}$

21. If  $2ax - 5x = 2$ , then  $x$  is equivalent to

- [A]  $\frac{2}{2a-5}$  [B]  $\frac{1}{a-5}$   
[C]  $\frac{2+5a}{2a}$  [D]  $7-2a$

22. If  $a > 0$ , then  $\sqrt{9a^2 + 16a^2}$  equals

- [A]  $5a$  [B]  $\sqrt{7a}$  [C]  $5\sqrt{a}$  [D]  $7a$

23. What is the sum of  $\frac{2}{x}$  and  $\frac{x}{2}$ ?
- [A]  $\frac{4+x}{2x}$                       [B]  $\frac{2+x}{2x}$   
[C]  $\frac{4+x^2}{2x}$                       [D] 1
24. Five people have volunteered to work on an awards dinner at Madison High School. How many different committees of four can be formed from the five people?
- [A] 1      [B] 20      [C] 5      [D] 10
25. The inequality  $\frac{1}{2}x + 3 < 2x - 6$  is equivalent to
- [A]  $x < -\frac{5}{6}$                       [B]  $x > -\frac{5}{6}$   
[C]  $x > 6$                       [D]  $x < 6$
26. In the coordinate plane, the points (2,2) and (2,12) are the endpoints of a diameter of a circle. What is the length of the radius of the circle?
- [A] 6      [B] 10      [C] 7      [D] 5
27. Which expression represents the number of yards in  $x$  feet?
- [A]  $\frac{x}{12}$       [B]  $3x$       [C]  $\frac{x}{3}$       [D]  $12x$
28. Which equation illustrates the associative property of addition?
- [A]  $(3 + x) + y = 3 + (x + y)$   
[B]  $3 + x = 0$   
[C]  $x + y = y + x$                       [D]  $3(x + 2) = 3x + 6$
29. If  $2x^2 - x + 6$  is subtracted from  $x^2 + 3x - 2$ , the result is
- [A]  $x^2 + 2x - 8$                       [B]  $-x^2 + 2x - 8$   
[C]  $-x^2 + 4x - 8$                       [D]  $x^2 - 4x + 8$
30. The expression  $(a^2 + b^2)^2$  is equivalent to
- [A]  $a^4 + a^2b^2 + b^4$                       [B]  $a^4 + 4a^2b^2 + b^4$   
[C]  $a^4 + 2a^2b^2 + b^4$   
[D]  $a^4 + b^4$
31. Julio's wages vary directly as the number of hours that he works. If his wages for 5 hours are \$29.75, how much will he earn for 30 hours?
32. TOP Electronics is a small business with five employees. The mean (average) weekly salary for the five employees is \$360. If the weekly salaries of four of the employees are \$340, \$340, \$345, and \$425, what is the salary of the fifth employee?
33. Bob and Latoya both drove to a baseball game at a college stadium. Bob lives 70 miles from the stadium and Latoya lives 60 miles from it, as shown in the accompanying diagram. Bob drove at a rate of 50 miles per hour, and Latoya drove at a rate of 40 miles per hour. If they both left home at the same time, who got to the stadium first?

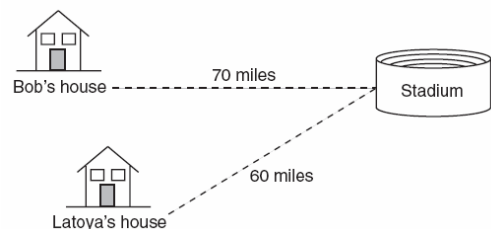

34. A car dealer has 22 vehicles on his lot. If 8 of the vehicles are vans and 6 of the vehicles are red, and 10 vehicles are neither vans nor red, how many red vans does he have on his lot?
35. In Jackson County, Wyoming, license plates are made with two letters (*A* through *Z*) followed by three digits (0 through 9). The plates are made according to the following restrictions:
- o the first letter must be *J* or *W*, and the second letter can be any of the 26 letters in the alphabet
  - o no digit can be repeated
- How many different license plates can be made with these restrictions?
36. Using only 32-cent and 20-cent stamps, Charlie put \$3.36 postage on a package he sent to his sister. He used twice as many 32-cent stamps as 20-cent stamps. Determine how many of *each* type of stamp he used.
37. A wheel has a radius of 5 feet. What is the minimum number of *complete* revolutions that the wheel must make to roll at least 1,000 feet?

38. In the accompanying diagram, the base of a 15-foot ladder rests on the ground 4 feet from a 6-foot fence.

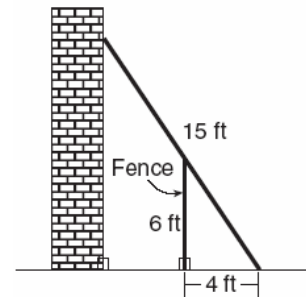

- a* If the ladder touches the top of the fence and the side of a building, what angle, to the *nearest degree*, does the ladder make with the ground?
- b* Using the angle found in part *a*, determine how far the top of the ladder reaches up the side of the building, to the *nearest foot*.
39. Tom throws a ball into the air. The ball travels on a parabolic path represented by the equation  $h = -8t^2 + 40t$ , where  $h$  is the height, in feet, and  $t$  is the time, in seconds.
- a* On the accompanying set of axes, graph the equation from  $t = 0$  to  $t = 5$  seconds, including all integral values of  $t$  from 0 to 5.

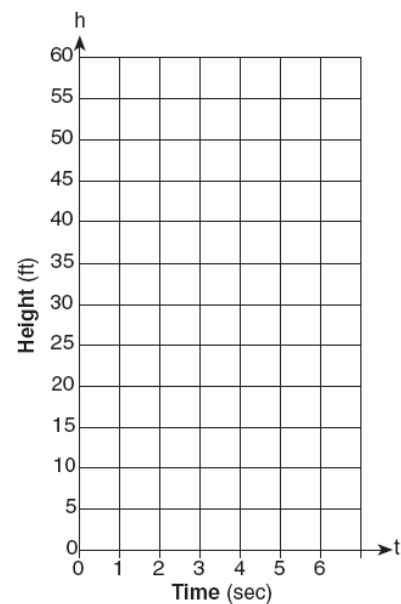

- b* What is the value of  $t$  at which  $h$  has its greatest value?

1. The test scores for 10 students in Ms. Sampson's homeroom were 61, 67, 81, 83, 87, 88, 89, 90, 98, and 100. Which frequency table is accurate for this set of data?

[A] 

Interval	Frequency
61-70	2
71-80	0
81-90	6
91-100	2

[B] 

Interval	Frequency
61-70	2
71-80	0
81-90	8
91-100	10

[C] 

Interval	Frequency
61-70	2
71-80	2
81-90	8
91-100	10

[D] 

Interval	Frequency
61-70	2
71-80	2
81-90	7
91-100	10

2. What is the image of  $(x, y)$  after a translation of 3 units right and 7 units down?

[A]  $(x + 3, y - 7)$       [B]  $(x - 3, y - 7)$

[C]  $(x - 3, y + 7)$       [D]  $(x + 3, y + 7)$

3. How many different outfits consisting of a hat, a pair of slacks, and a sweater can be made from two hats, three pairs of slacks, and four sweaters?

[A] 29      [B] 9      [C] 12      [D] 24

4. If  $3(x - 2) = 2x + 6$ , the value of  $x$  is

[A] 0      [B] 5      [C] 20      [D] 12

5. Which statement is logically equivalent to "If a triangle is an isosceles triangle, then it has two congruent sides"?

[A] If a triangle does not have two congruent sides, then it is not an isosceles triangle.

[B] If a triangle is not an isosceles triangle, then it has two congruent sides.

[C] If a triangle is an isosceles triangle, then it does not have two congruent sides.

[D] If a triangle does not have two congruent sides, then it is an isosceles triangle.

6. Parking charges at Superior Parking Garage are \$5.00 for the first hour and \$1.50 for each additional 30 minutes. If Margo has \$12.50, what is the maximum amount of time she will be able to park her car at the garage?

[A]  $3\frac{1}{2}$  hours      [B]  $2\frac{1}{2}$  hours

[C] 6 hours      [D]  $6\frac{1}{2}$  hours

7. If the temperature in Buffalo is  $23^\circ$  Fahrenheit, what is the temperature in degrees Celsius? [Use the formula  $C = \frac{5}{9}(F - 32)$ .]

[A] 45      [B] -5      [C] -45      [D] 5

8. Tara buys two items that cost  $d$  dollars each. She gives the cashier \$20. Which expression represents the change she should receive?

[A]  $20 + 2d$       [B]  $20 - d$

[C]  $20 - 2d$       [D]  $2d - 20$

9. At the beginning of her mathematics class, Mrs. Reno gives a warm-up problem. She says, "I am thinking of a number such that 6 less than the product of 7 and this number is 85." Which number is she thinking of?

[A] 13      [B]  $11\frac{2}{7}$       [C] 637      [D] 84



10. Which type of transformation is illustrated in the accompanying diagram?

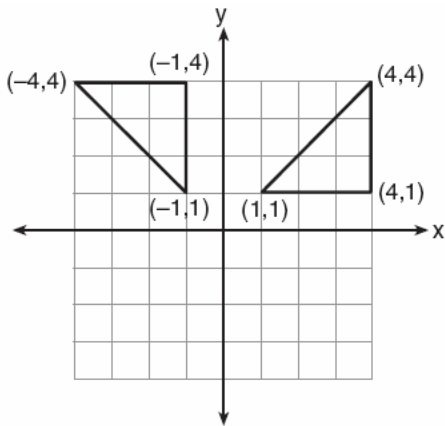

- [A] dilation                      [B] reflection  
[C] rotation                      [D] translation
11. Delroy's sailboat has two sails that are similar triangles. The larger sail has sides of 10 feet, 24 feet, and 26 feet. If the shortest side of the smaller sail measures 6 feet, what is the perimeter of the *smaller* sail?
- [A] 36 ft                      [B] 100 ft  
[C] 15 ft                      [D] 60 ft
12. What is the least common denominator of  $\frac{1}{2}$ ,  $\frac{2}{7x}$ , and  $\frac{5}{x}$ ?
- [A]  $9x$     [B]  $14x^2$     [C]  $14x$     [D]  $2x$
13. Which property of real numbers is illustrated by the equation  $-\sqrt{3} + \sqrt{3} = 0$ ?
- [A] commutative property of addition  
[B] associative property of addition  
[C] additive identity    [D] additive inverse

14. The ratio of two supplementary angles is 2:7. What is the measure of the *smaller* angle?
- [A]  $14^\circ$     [B]  $40^\circ$     [C]  $20^\circ$     [D]  $10^\circ$
15. Mary chooses an integer at random from 1 to 6. What is the probability that the integer she chooses is a prime number?
- [A]  $\frac{4}{6}$     [B]  $\frac{5}{6}$     [C]  $\frac{2}{6}$     [D]  $\frac{3}{6}$
16. The statement " $x$  is *not* the square of an integer and  $x$  is a multiple of 3" is true when  $x$  is equal to
- [A] 18    [B] 32    [C] 36    [D] 9
17. Which phrase does *not* describe a triangle?
- [A] obtuse right              [B] acute scalene  
[C] isosceles right  
[D] equilateral equiangular
18. The number of people on the school board is represented by  $x$ . Two subcommittees with an equal number of members are formed, one with  $\frac{2}{3}x - 5$  members and the other with  $\frac{x}{4}$  members. How many people are on the school board?
- [A] 4    [B] 8    [C] 12    [D] 20

19. The angle of elevation from a point 25 feet from the base of a tree on level ground to the top of the tree is  $30^\circ$ . Which equation can be used to find the height of the tree?

[A]  $\sin 30^\circ = \frac{x}{25}$       [B]  $\tan 30^\circ = \frac{x}{25}$   
[C]  $30^2 + 25^2 = x^2$       [D]  $\cos 30^\circ = \frac{x}{25}$

20. Rashawn bought a CD that cost \$18.99 and paid \$20.51, including sales tax. What was the rate of the sales tax?

[A] 2%    [B] 5%    [C] 8%    [D] 3%

21. If  $3x$  is one factor of  $3x^2 - 9x$ , what is the other factor?

[A]  $x - 3$                       [B]  $x + 3$   
[C]  $x^2 - 6x$                   [D]  $3x$

22. The accompanying circle graph shows how the Marino family spends its income each month.

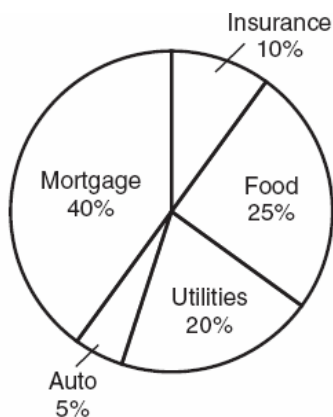

What is the measure, in degrees, of the central angle that represents the percentage of income spent on food?

[A] 50    [B] 25    [C] 90    [D] 360

23. Melissa is walking around the outside of a building that is in the shape of a regular polygon. She determines that the measure of one exterior angle of the building is  $60^\circ$ . How many sides does the building have?

[A] 6    [B] 9    [C] 12    [D] 3

24. Which expression is an example of the associative property?

[A]  $x(y + z) = xy + xz$   
[B]  $x + y + z = z + y + x$   
[C]  $(x + y) + z = x + (y + z)$   
[D]  $x \cdot 1 = x$

25. A farmer has a rectangular field that measures 100 feet by 150 feet. He plans to increase the area of the field by 20%. He will do this by increasing the length and width by the same amount,  $x$ . Which equation represents the area of the new field?

[A]  $(100 + x)(150 + x) = 18,000$   
[B]  $(100 + x)(150 + x) = 15,000$   
[C]  $(100 + 2x)(150 + x) = 18,000$   
[D]  $2(100 + x) + 2(150 + x) = 15,000$

26. In a game, each player receives 5 cards from a deck of 52 different cards. How many different groupings of cards are possible in this game?

[A]  $\frac{52!}{5!}$     [B]  ${}_{52}C_5$     [C]  ${}_{52}P_5$     [D]  $5!$

27. A box in the shape of a cube has a volume of 64 cubic inches. What is the length of a side of the box?

- [A] 16 in                      [B] 4 in  
[C] 8 in                      [D]  $21\bar{3}$  in

28. The line  $3x - 2y = 12$  has

- [A] a slope of -3 and a  $y$ -intercept of -6  
[B] a slope of  $-\frac{3}{2}$  and a  $y$ -intercept of 6  
[C] a slope of 3 and a  $y$ -intercept of -2  
[D] a slope of  $\frac{3}{2}$  and a  $y$ -intercept of -6

29. If the mass of a proton is  $1.67 \times 10^{-24}$  gram, what is the mass of 1,000 protons?

- [A]  $1.67 \times 10^{-21}$               [B]  $1.67 \times 10^{-27}$   
[C]  $1.67 \times 10^{-22}$               [D]  $1.67 \times 10^{-23}$

30. If  $(x - 4)$  is a factor of  $x^2 - x - w = 0$ , then the value of  $w$  is

- [A] -3      [B] -12      [C] 3      [D] 12

31. In the accompanying diagram of  $\triangle BCD$ ,  $m\angle C = 70$ ,  $m\angle CDE = 130$ , and side  $\overline{BD}$  is extended to  $A$  and to  $E$ . Find  $m\angle CBA$ .

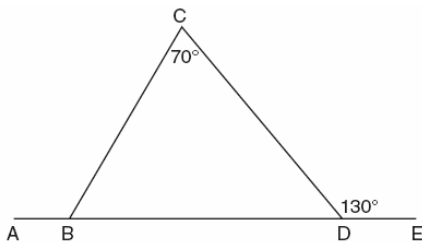

32. Brett was given the problem: "Evaluate  $2x^2 + 5$  when  $x = 3$ ." Brett wrote that the answer was 41. Was Brett correct? Explain your answer.

33. Kyoko's mathematics teacher gave her the accompanying cards and asked her to arrange the cards in order from least to greatest. In what order should Kyoko arrange the cards?

$\pi$	$\sqrt{8}$	$3.\bar{1}$	$2\sqrt{3}$	$2\frac{4}{5}$
-------	------------	-------------	-------------	----------------

34. The coordinates of the midpoint of  $\overline{AB}$  are  $(2,4)$ , and the coordinates of point  $B$  are  $(3,7)$ . What are the coordinates of point  $A$ ? [The use of the accompanying grid is optional.]

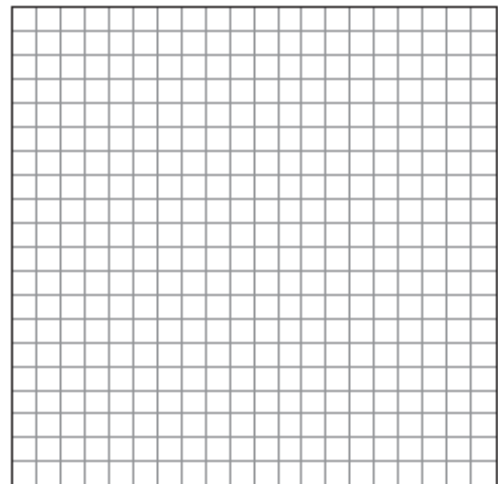

35. Using only a compass and a straightedge, construct the perpendicular bisector of  $\overline{AB}$  and label it  $c$ . [Leave all construction marks.]

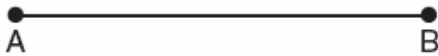

38. On the first six tests in her social studies course, Jerelyn's scores were 92, 78, 86, 92, 95, and 91. Determine the median and the mode of her scores. If Jerelyn took a seventh test and raised the mean of her scores exactly 1 point, what was her score on the seventh test?

39. Solve the following system of equations algebraically or graphically:

$$x^2 + y^2 = 25$$

$$3y - 4x = 0$$

[The use of the accompanying grid is optional.]

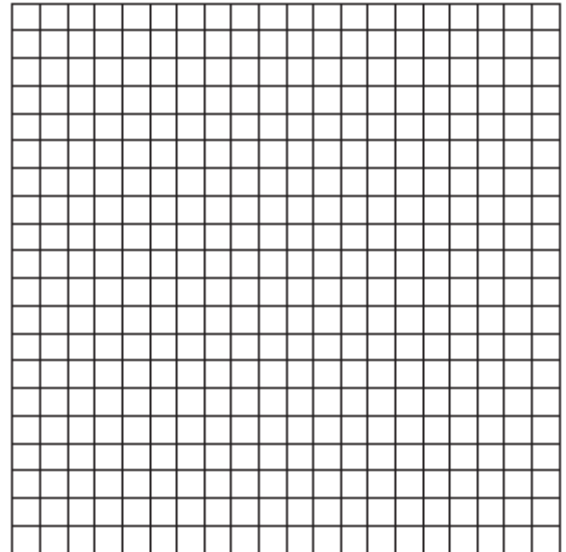

36. The senior class at South High School consists of 250 students. Of these students, 130 have brown hair, 160 have brown eyes, and 90 have both brown hair and brown eyes. How many members of the senior class have *neither* brown hair *nor* brown eyes?

37. Express both the perimeter and the area of the rectangle shown in the accompanying diagram as polynomials in simplest form.

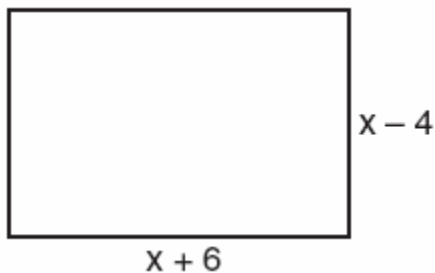

1. Which diagram shows a dotted line that is *not* a line of symmetry?

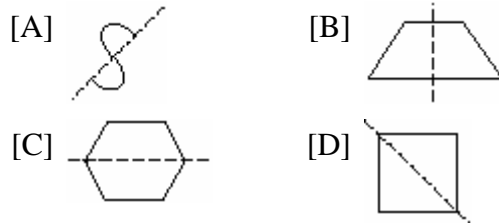

2. Rosario and Enrique are in the same mathematics class. On the first five tests, Rosario received scores of 78, 77, 64, 86, and 70. Enrique received scores of 90, 61, 79, 73, and 87. How much higher was Enrique's average than Rosario's average?

[A] 3 points                      [B] 4 points  
[C] 15 points                    [D] 2 points

3. Which diagram represents the figure with the greatest volume?

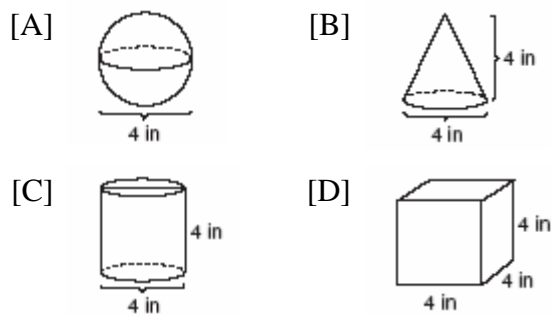

4. The school cafeteria offers five sandwich choices, four desserts, and three beverages. How many different meals consisting of one sandwich, one dessert, and one beverage can be ordered?

[A] 12      [B] 1      [C] 3      [D] 60

5. When  $-9x^5$  is divided by  $-3x^3$ ,  $x \neq 0$ , the quotient is

[A]  $27x^8$                       [B]  $-3x^2$   
[C]  $-27x^{15}$                   [D]  $3x^2$

6. What is the value of  $n$  in the equation  $0.6(n + 10) = 3.6$ ?

[A] -0.4    [B] 5      [C] -4      [D] 4

7.  $\overline{AB}$  and  $\overline{CD}$  intersect at point  $E$ ,  $m\angle AEC = 6x + 20$ , and  $m\angle DEB = 10x$ . What is the value of  $x$ ?

[A]  $4\frac{3}{8}$     [B]  $21\frac{1}{4}$     [C] 5      [D] 10

8. If  $x = -4$  and  $y = 3$ , what is the value of  $x - 3y^2$ ?

[A] -13    [B] -85    [C] -23    [D] -31

9. What are the coordinates of  $P'$ , the image of  $P(-4, 0)$  under the translation  $(x - 3, y + 6)$ ?

[A] (1,6)                      [B] (2,-3)  
[C] (7,-6)                    [D] (-7,6)

10. The accompanying graph shows the amount of water left in Rover's water dish over a period of time.

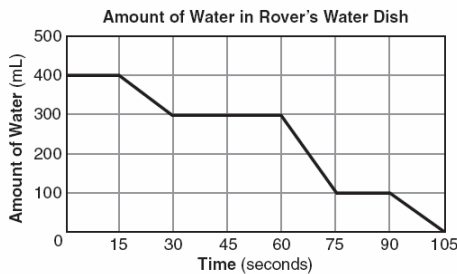

How long did Rover wait from the end of his first drink to the start of his second drink of water?

- [A] 75 sec                      [B] 10 sec  
[C] 60 sec                      [D] 30 sec
11. Which inequality is represented in the accompanying graph?



- [A]  $-3 \leq x \leq 4$             [B]  $-3 \leq x < 4$   
[C]  $-3 < x \leq 4$             [D]  $-3 < x < 4$
12. The ratio of Tariq's telephone bill to Pria's telephone bill was 7:5. Tariq's bill was \$14 more than Pria's bill. What was Tariq's bill?
- [A] \$49    [B] \$35    [C] \$28    [D] \$21

13. Which equation illustrates the distributive property of multiplication over addition?
- [A]  $6(3a + 4b) = 18a + 4b$   
[B]  $6(3a + 4b) = (3a + 4b)6$   
[C]  $6(3a + 4b) = 18a + 24b$   
[D]  $6(3a + 4b) = 6(4b + 3a)$

14. Which ratio represents  $\cos A$  in the accompanying diagram of  $\triangle ABC$ ?

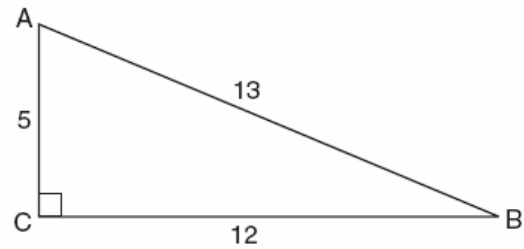

- [A]  $\frac{5}{13}$     [B]  $\frac{12}{5}$     [C]  $\frac{13}{5}$     [D]  $\frac{12}{13}$

15. A rocket car on the Bonneville Salt Flats is traveling at a rate of 640 miles per hour. How much time would it take for the car to travel 384 miles at this rate?

- [A] 245 minutes            [B] 36 minutes  
[C] 1.7 hours              [D] 256 minutes

16. What is the inverse of the statement "If I do not buy a ticket, then I do not go to the concert"?

- [A] If I do not go to the concert, then I do not buy a ticket.  
[B] If I buy a ticket, then I do not go to the concert.  
[C] If I go to the concert, then I buy a ticket.  
[D] If I buy a ticket, then I go to the concert.

17. If the value of dependent variable  $y$  increases as the value of independent variable  $x$  increases, the graph of this relationship could be a

- [A] line with a negative slope  
[B] line with a positive slope  
[C] horizontal line    [D] vertical line

18. What is the image of point  $(-3, -1)$  under a reflection in the origin?

- [A]  $(-1, -3)$                       [B]  $(1, 3)$   
[C]  $(3, 1)$                           [D]  $(-3, 1)$

19. Seventy-eight students participate in one or more of three sports: baseball, tennis, and golf. Four students participate in all three sports; five play both baseball and golf, only; two play both tennis and golf, only; and three play both baseball and tennis, only. If seven students play only tennis and one plays only golf, what is the total number of students who play only baseball?

- [A] 12      [B] 44      [C] 56      [D] 60

20. Which linear equation represents the data in the accompanying table?

$c$	$d$
0	20.00
1	21.50
2	23.00
3	24.50

- [A]  $d = 1.50c + 20.00$   
[B]  $d = 20.00c + 1.50$   
[C]  $d = 21.50c$                       [D]  $d = 1.50c$

21. The accompanying diagram shows a football player crossing the 20-yard line at an angle of  $30^\circ$  and continuing along the same path.

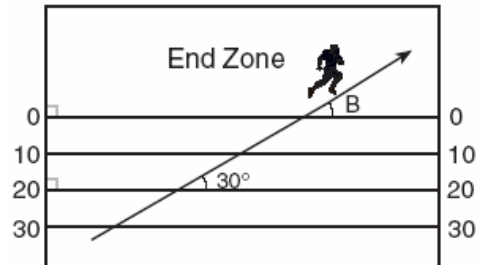

What is the measure of angle B, where the player crosses into the end zone?

- [A]  $60^\circ$       [B]  $180^\circ$       [C]  $30^\circ$       [D]  $150^\circ$

22. For which value of  $x$  is the expression  $\frac{x-7}{x+2}$  undefined?

- [A] 2      [B] 0      [C] 7      [D] -2

23. The expression  $(3x^2 + 2xy + 7) - (6x^2 - 4xy + 3)$  is equivalent to

- [A]  $3x^2 - 2xy + 4$                       [B]  $-3x^2 + 6xy + 4$   
[C]  $-3x^2 - 2xy + 4$                       [D]  $3x^2 - 6xy - 4$

24. The number  $156 \times 10^{-2}$  is equivalent to

- [A] 0.00156                      [B] 0.156  
[C] 156                              [D] 0.0156

25. Which set can *not* represent the lengths of the sides of a triangle?

- [A]  $\{4, 5, 6\}$                       [B]  $\{7, 7, 12\}$   
[C]  $\{8, 8, 8\}$                       [D]  $\{5, 5, 11\}$

26. Which equation represents the locus of points 4 units from the origin?

- [A]  $x = 4$                       [B]  $x^2 + y^2 = 4$   
[C]  $x^2 + y^2 = 16$             [D]  $x + y = 16$

27. What is the contrapositive of the statement "If I study, then I pass the test"?

- [A] If I pass the test, then I study.  
[B] If I do not pass the test, then I do not study.  
[C] If I do not study, then I do not pass the test.  
[D] I pass the test if I study.

28. What is the sum, in degrees, of the measures of the interior angles of a stop sign, which is in the shape of an octagon?

- [A] 1,880                      [B] 360  
[C] 1,080                      [D] 1,440

29. What point is the intersection of the graphs of the lines  $2x - y = 3$  and  $x + y = 3$ ?

- [A] (2, 1)                      [B] (1, 2)  
[C] (3, 0)                      [D] (3, 3)

30. Selena and Tracey play on a softball team. Selena has 8 hits out of 20 times at bat, and Tracey has 6 hits out of 16 times at bat. Based on their past performance, what is the probability that both girls will get a hit next time at bat?

- [A]  $\frac{14}{36}$     [B]  $\frac{31}{40}$     [C] 1        [D]  $\frac{48}{320}$

31. Two angles are complementary. One angle has a measure that is five times the measure of the other angle. What is the measure, in degrees, of the larger angle?

32. Given:  $\frac{\sqrt{99}}{11}$ ,  $\sqrt{164}$ ,  $\sqrt{196}$

Identify the expression that is a rational number and explain why it is rational.

33. Dylan says that all isosceles triangles are acute triangles. Mary Lou wants to prove that Dylan is *not* correct. Sketch an isosceles triangle that Mary Lou could use to show that Dylan's statement is not true. In your sketch, state the measure of *each* angle of the isosceles triangle.

34. Factor completely:  $3ax^2 - 27a$

35. The accompanying circle graph shows the favorite colors of the 300 students in the ninth grade. How many students chose red as their favorite color?

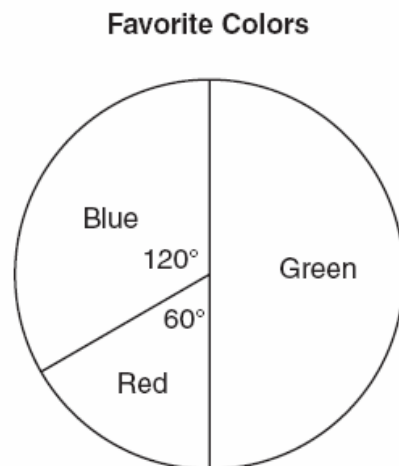



36. Walter is a waiter at the Towne Diner. He earns a daily wage of \$50, plus tips that are equal to 15% of the total cost of the dinners he serves. What was the total cost of the dinners he served if he earned \$170 on Tuesday?

37. The following set of data represents the scores on a mathematics quiz:  
58, 79, 81, 99, 68, 92, 76, 84, 53, 57, 81, 91, 77, 50, 65, 57, 51, 72, 84, 89  
Complete the frequency table below and, on the accompanying grid, draw and label a frequency histogram of these scores.

Mathematics Quiz Scores

Interval	Tally	Frequency
50-59		
60-69		
70-79		
80-89		
90-99		

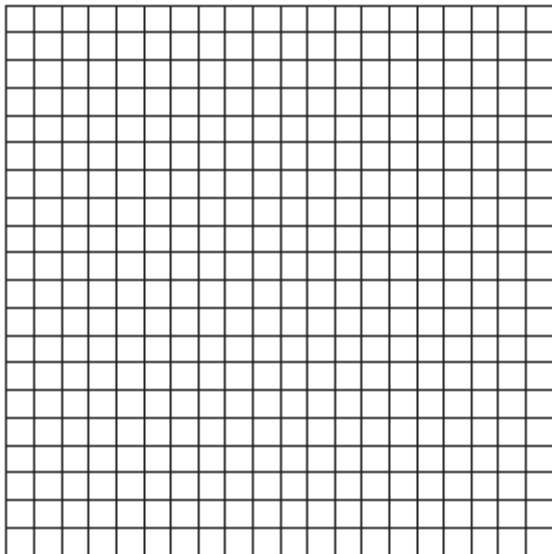

38. In the accompanying diagram, right triangle  $ABC$  is inscribed in circle  $O$ , diameter  $AB = 26$ , and  $CB = 10$ . Find, to the nearest square unit, the area of the shaded region.

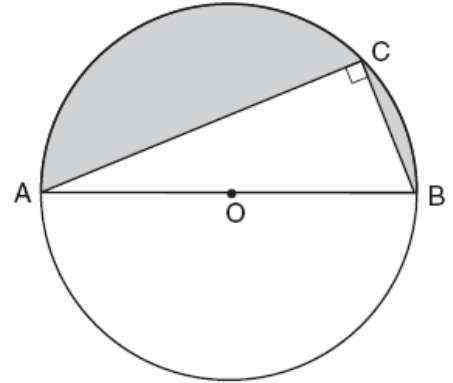

39. Solve for all values of  $x$  that satisfy the equation  $\frac{x}{x+3} = \frac{5}{x+7}$ .

1. Stan was trying to guess Melanie's age. She told him her age was an even number and a multiple of three. What could be Melanie's age?

[A] 10 [B] 16 [C] 15 [D] 12

2. In the accompanying diagram, lines  $a$  and  $b$  are parallel, and lines  $c$  and  $d$  are transversals.

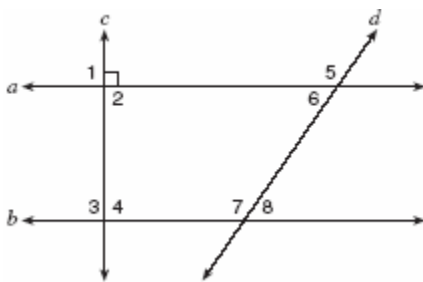

Which angle is congruent to angle 8?

[A] 5 [B] 4 [C] 6 [D] 3

3. A deli has five types of meat, two types of cheese, and three types of bread. How many different sandwiches, consisting of one type of meat, one type of cheese, and one type of bread, does the deli serve?

[A] 30 [B] 75 [C] 10 [D] 25

4. The accompanying histogram shows the heights of the students in Kyra's health class.

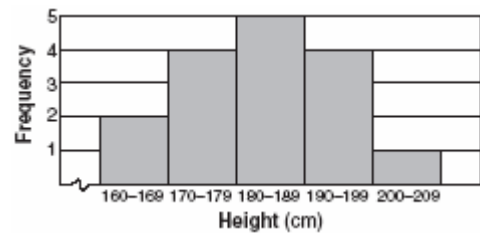

What is the total number of students in the class?

[A] 16 [B] 15 [C] 209 [D] 5

5. The perimeter of  $\triangle A'B'C'$ , the image of  $\triangle ABC$ , is twice as large as the perimeter of  $\triangle ABC$ . What type of transformation has taken place?

[A] rotation [B] translation  
[C] reflection [D] dilation

6. If  $n + 4$  represents an odd integer, the next larger odd integer is represented by

[A]  $n + 6$  [B]  $n + 3$   
[C]  $n + 2$  [D]  $n + 5$

7. What is the solution set of the equation

$$\frac{x}{5} + \frac{x}{2} = 14?$$

[A] {4} [B] {10}  
[C] {20} [D] {49}

8. The NuFone Communications Company must run a telephone line between two poles at opposite ends of a lake, as shown in the accompanying diagram. The length and width of the lake are 75 feet and 30 feet, respectively.

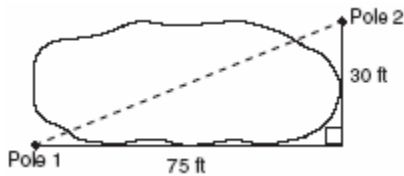

What is the distance between the two poles, to the nearest foot?

- [A] 81    [B] 69    [C] 45    [D] 105
9. The image of point  $(3,-5)$  under the translation that shifts  $(x,y)$  to  $(x-1, y-3)$  is
- [A]  $(2,8)$                       [B]  $(-4,8)$   
[C]  $(2,-8)$                       [D]  $(-3,15)$
10. Which letter has point symmetry, but *not* line symmetry?
- [A] S    [B] X    [C] H    [D] T
11. Which expression is equivalent to  $x^{-4}$ ?
- [A]  $x^4$     [B]  $-4x$     [C] 0    [D]  $\frac{1}{x^4}$
12. If  $x^3 < x < \frac{1}{x}$ , then  $x$  could be equal to
- [A]  $\frac{1}{5}$     [B]  $\frac{6}{5}$     [C] 5    [D] 1
13. Which statement is logically equivalent to the statement "If you are an elephant, then you do not forget"?
- [A] If you do not forget, then you are an elephant.  
[B] If you do not forget, then you are not an elephant.  
[C] If you forget, then you are not an elephant.  
[D] If you are an elephant, then you forget.
14. What is the sum, in degrees, of the measures of the interior angles of a pentagon?
- [A] 180    [B] 540    [C] 900    [D] 360
15. How many different three-member teams can be selected from a group of seven students?
- [A] 1    [B] 5,040    [C] 35    [D] 210
16. What is the multiplicative inverse of  $\frac{3}{4}$ ?
- [A]  $-\frac{4}{3}$     [B] -1    [C]  $\frac{4}{3}$     [D]  $-\frac{3}{4}$

17. Sean knows the length of the base,  $b$ , and the area,  $A$ , of a triangular window in his bedroom. Which formula could he use to find the height,  $h$ , of this window?
- [A]  $h = (2A)(b)$       [B]  $h = 2A - b$   
[C]  $h = \frac{A}{2b}$       [D]  $h = \frac{2A}{b}$
18. The expression  $-|-7|$  is equivalent to
- [A] -7      [B] 7      [C] 0      [D] 1
19. In Ms. Wright's English class, 16 students are in band, 7 students play sports, 3 students participate in both activities, and 9 students are not in band and do not play sports. How many students are in Ms. Wright's English class?
- [A] 7      [B] 29      [C] 10      [D] 26
20. What is the solution set for the equation  $x^2 - 5x + 6 = 0$
- [A]  $\{-6, 1\}$       [B]  $\{-2, -3\}$   
[C]  $\{6, -1\}$       [D]  $\{2, 3\}$
21. If the midpoints of the sides of a triangle are connected, the area of the triangle formed is what part of the area of the original triangle?
- [A]  $\frac{1}{4}$       [B]  $\frac{3}{8}$       [C]  $\frac{1}{3}$       [D]  $\frac{1}{2}$
22. Which equation represents a line that is parallel to the line whose equation is  $2x + 3y = 12$ ?
- [A]  $6y - 4x = 2$       [B]  $4x - 6y = 2$   
[C]  $6y + 4x = 2$       [D]  $6x + 4y = -2$
23. When  $3x^2 - 8x$  is subtracted from  $2x^2 + 3x$ , the difference is
- [A]  $-x^2 + 11x$       [B]  $x^2 - 5x$   
[C]  $-x^2 - 11x$       [D]  $-x^2 - 5x$
24. The coordinates of point  $R$  are  $(-3, 2)$  and the coordinates of point  $T$  are  $(4, 1)$ . What is the length of  $\overline{RT}$ ?
- [A]  $5\sqrt{2}$       [B]  $2\sqrt{2}$   
[C]  $\sqrt{10}$       [D]  $4\sqrt{3}$
25. A student council has seven officers, of which five are girls and two are boys. If two officers are chosen at random to attend a meeting with the principal, what is the probability that the first officer chosen is a girl and the second is a boy?
- [A]  $\frac{7}{13}$       [B]  $\frac{10}{42}$       [C]  $\frac{7}{14}$       [D]  $\frac{2}{7}$

26. Which expression has the *smallest* value?

- [A]  $-\pi$                       [B]  $-\frac{16}{5}$   
[C]  $-3.02$                     [D]  $-\sqrt{10}$

27. How many points are equidistant from two parallel lines and also equidistant from two points on one of the lines?

- [A] 3      [B] 1      [C] 4      [D] 2

28. Which point is in the solution set of the system of inequalities shown in the accompanying graph?

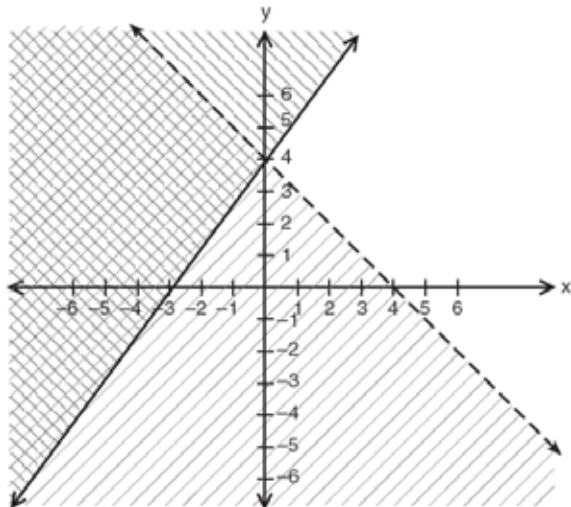

- [A] (0, 4)                      [B] (4, -1)  
[C] (2, 4)                      [D] (-4, 1)

29. Expressed in its simplest form,  $(3x^3)(2y)^2(4x^4)$  is equivalent to

- [A]  $48x^7y^2$                       [B]  $24x^7y^2$   
[C]  $48x^{12}y^2$                     [D]  $24x^{12}y^2$

30. When  $\sqrt{72}$  is expressed in simplest  $a\sqrt{b}$  form, what is the value of  $a$ ?

- [A] 6      [B] 3      [C] 2      [D] 8

31. In the accompanying diagram, a ladder leaning against a building makes an angle of  $58^\circ$  with level ground. If the distance from the foot of the ladder to the building is 6 feet, find, to the *nearest foot*, how far up the building the ladder will reach.



32. Fran's favorite photograph has a length of 6 inches and a width of 4 inches. She wants to have it made into a poster with dimensions that are similar to those of the photograph. She determined that the poster should have a length of 24 inches. How many inches wide will the poster be?

33. In rectangle  $ABCD$ ,  $AC = 3x + 15$  and  $BD = 4x - 5$ . Find the length of  $\overline{AC}$ .
34. José wants to build a triangular pen for his pet rabbit. He has three lengths of boards already cut that measure 7 feet, 8 feet, and 16 feet. Explain why José cannot construct a pen in the shape of a triangle with sides of 7 feet, 8 feet, and 16 feet.
35. Construct a stem-and-leaf plot listing the scores below in order from lowest to highest.  
15, 25, 28, 32, 39, 40, 43, 26, 50, 75, 65, 19, 55, 72, 50

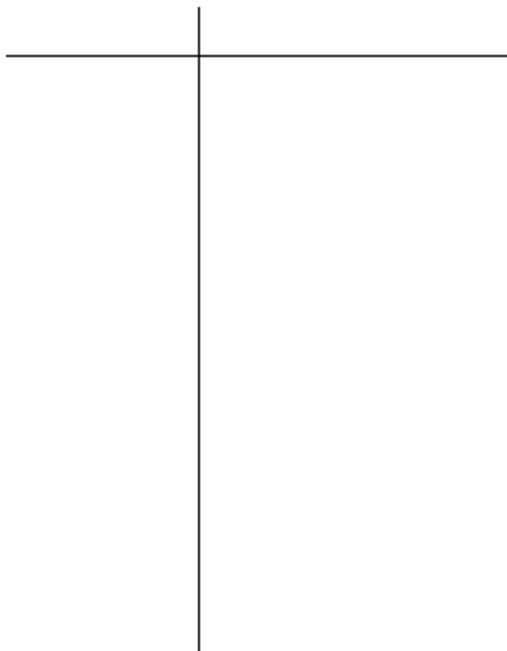

36. Find all negative odd integers that satisfy the following inequality:  
 $-3x + 1 \leq 17$
37. As shown in the accompanying diagram, the length, width, and height of Richard's fish tank are 24 inches, 16 inches, and 18 inches, respectively. Richard is filling his fish tank with water from a hose at the rate of 500 cubic inches per minute. How long will it take, to the *nearest minute*, to fill the tank to a depth of 15 inches?

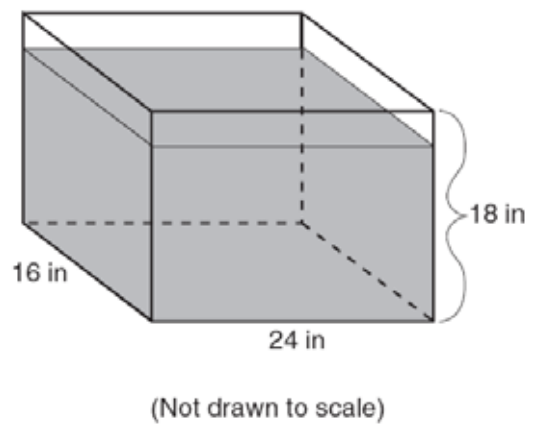

38. In  $\triangle ABC$ , the measure of  $\angle B$  is 21 less than four times the measure of  $\angle A$ , and the measure of  $\angle C$  is 1 more than five times the measure of  $\angle A$ . Find the measure, in degrees, of *each* angle of  $\triangle ABC$ .
39. The tickets for a dance recital cost \$5.00 for adults and \$2.00 for children. If the total number of tickets sold was 295 and the total amount collected was \$1,220, how many adult tickets were sold? [Only an algebraic solution can receive full credit.]

1. Jeremy's bedroom has two doors leading into the hallway. His house has four doors leading to the outside. Using the doorways, in how many different ways can Jeremy leave his room and go outside?

[A] 4      [B] 6      [C] 8      [D] 5

2. The amount of time,  $t$ , in seconds, it takes an object to fall a distance,  $d$ , in meters, is

expressed by the formula  $t = \sqrt{\frac{d}{4.9}}$ .

Approximately how long will it take an object to fall 75 meters?

[A] 3.9 sec                      [B] 7.7 sec  
[C] 0.26 sec                    [D] 2.34 sec

3. Which equation illustrates the distributive property?

[A]  $a + b = b + a$       [B]  $5(a + b) = 5a + 5b$   
[C]  $a + 0 = a$   
[D]  $a + (b + c) = (a + b) + c$

4. The mass of an orchid seed is approximately 0.0000035 gram. Written in scientific notation, that mass is equivalent to  $3.5 \times 10^n$ . What is the value of  $n$ ?

[A] -5      [B] -8      [C] -7      [D] -6

5. A cake recipe calls for 1.5 cups of milk and 3 cups of flour. Seth made a mistake and used 5 cups of flour. How many cups of milk should he use to keep the proportions correct?

[A] 2.5      [B] 1.75      [C] 2      [D] 2.25

6. When  $3x^2 - 6x$  is divided by  $3x$ , the result is

[A]  $x + 2$                       [B]  $2x$   
[C]  $-2x$                         [D]  $x - 2$

7. The accompanying diagram shows the graphs of a linear equation and a quadratic equation.

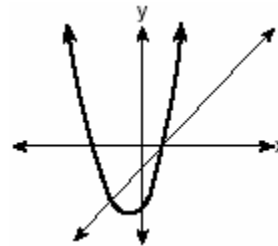

How many solutions are there to this system of equations?

[A] 3      [B] 2      [C] 1      [D] 0

8. A picture held by a magnet to a refrigerator slides to the bottom of the refrigerator, as shown in the accompanying diagram.

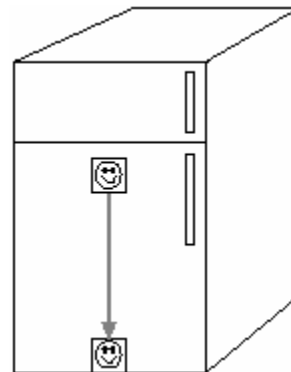

This change of position is an example of a

[A] reflection                      [B] rotation  
[C] translation                    [D] dilation

9. Jorge made the accompanying stem-and-leaf plot of the weights, in pounds, of each member of the wrestling team he was coaching.

Stem	Leaf
10	9
11	
12	3 8
13	2 4 4 6 8
14	1 3 5 5 9
15	2 3 7 7 9
16	1 3 7 8 8 8 9
17	3 8

Key: 16 | 1 = 161

What is the mode of the weights?

- [A] 150 [B] 145 [C] 152 [D] 168

10. Tina wants to sew a piece of fabric into a scarf in the shape of an isosceles triangle, as shown in the accompanying diagram.

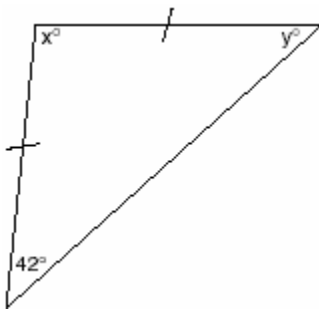

What are the values of  $x$  and  $y$ ?

- [A]  $x = 42$  and  $y = 96$   
 [B]  $x = 96$  and  $y = 42$   
 [C]  $x = 69$  and  $y = 69$   
 [D]  $x = 90$  and  $y = 48$

11. The expression  $(x^2 - 5x - 2) - (-6x^2 - 7x - 3)$  is equivalent to

- [A]  $7x^2 + 2x - 5$  [B]  $7x^2 - 12x - 5$   
 [C]  $7x^2 + 2x + 1$  [D]  $7x^2 - 2x + 1$

12. The expression  $\sqrt{50} + \sqrt{32}$  is equivalent to  
 [A]  $\sqrt{82}$  [B] 18 [C]  $9\sqrt{2}$  [D] 6

13. If  $7x + 2a = 3x + 5a$ , then  $x$  is equivalent to

- [A]  $\frac{7a}{4}$  [B]  $\frac{3a}{10}$  [C]  $\frac{7a}{10}$  [D]  $\frac{3a}{4}$

14. What is the solution set of the equation  $x^2 + 11x + 28 = 0$ ?

- [A] {3,4} [B] {-7,4}  
 [C] {-3,-4} [D] {-7,-4}

15. Which set could *not* represent the lengths of the sides of a triangle?

- [A] {2,5,9} [B] {3,4,5}  
 [C] {5,10,12} [D] {7,9,11}

16. The accompanying figure represents a section of bathroom floor tiles shaped like regular hexagons.

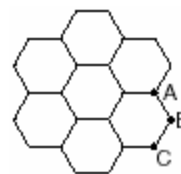

What is the measure of angle  $ABC$ ?

- [A]  $150^\circ$  [B]  $90^\circ$   
 [C]  $60^\circ$  [D]  $120^\circ$

17. The statement "If  $x$  is prime, then it is odd" is false when  $x$  equals

- [A] 1 [B] 3 [C] 2 [D] 4





29. The probability that the Cubs win their first game is  $\frac{1}{3}$ . The probability that the Cubs win their second game is  $\frac{3}{7}$ . What is the probability that the Cubs win both games?
- [A]  $\frac{2}{5}$     [B]  $\frac{1}{7}$     [C]  $\frac{16}{21}$     [D]  $\frac{6}{7}$

30. A storage container in the shape of a right circular cylinder is shown in the accompanying diagram.

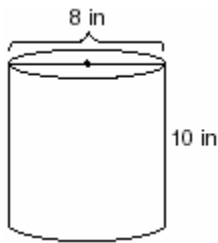

What is the volume of this container, to the nearest hundredth?

- [A]  $125.66 \text{ in}^3$     [B]  $502.65 \text{ in}^3$   
[C]  $56.55 \text{ in}^3$     [D]  $251.33 \text{ in}^3$
31. A ribbon 56 centimeters long is cut into two pieces. One of the pieces is three times longer than the other. Find the lengths, in centimeters, of both pieces of ribbon.

32. The manufacturer of Ron's car recommends that the tire pressure be at least 26 pounds per square inch and less than 35 pounds per square inch. On the accompanying number line, graph the inequality that represents the recommended tire pressure.

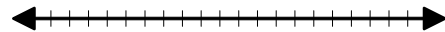

33. In a survey of 400 teenage shoppers at a large mall, 240 said they shopped at Abernathy's, 210 said they shopped at Bongo Republic, and 90 said they shopped at both stores. How many of the teenage shoppers surveyed did not shop at either store?
34. An algebra class of 21 students must send 5 students to meet with the principal. How many different groups of 5 students could be formed from this class?
35. Factor completely:  $3x^2 + 15x - 42$
36. Mr. James wanted to plant a garden that would be in the shape of a rectangle. He was given 80 feet of fencing to enclose his garden. He wants the length to be 10 feet more than twice the width. What are the dimensions, in feet, for a rectangular garden that will use exactly 80 feet of fencing?

37. On the accompanying set of axes, draw the reflection of  $ABCD$  in the  $y$ -axis. Label and state the coordinates of the reflected figure.

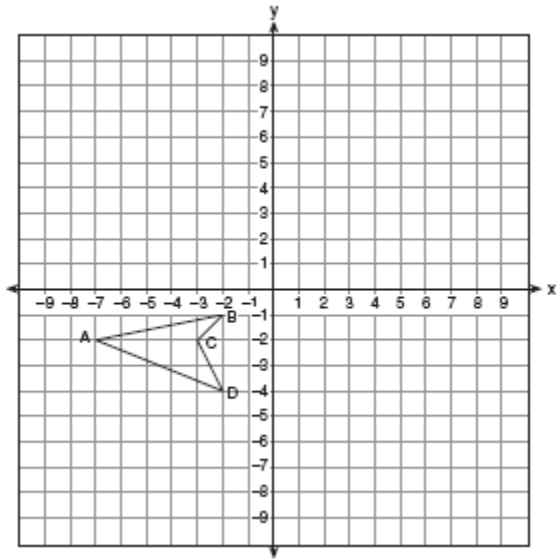

38. In a class of 24 students, 10 have brown hair, 8 have black hair, 4 have blond hair, and 2 have red hair. On the accompanying diagram, construct a circle graph to show the students' hair color.

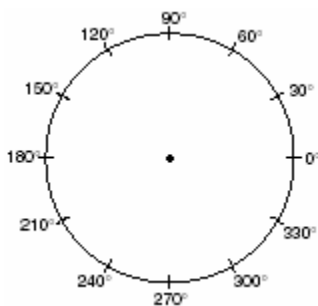

39. The accompanying diagram shows a flagpole that stands on level ground. Two cables,  $r$  and  $s$ , are attached to the pole at a point 16 feet above the ground. The combined length of the two cables is 50 feet. If cable  $r$  is attached to the ground 12 feet from the base of the pole, what is the measure of the angle,  $x$ , to the nearest degree, that cable  $s$  makes with the ground?

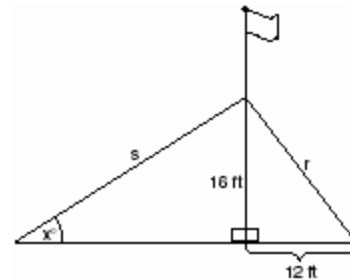

1. The weights of all the students in grade 9 are arranged from least to greatest. Which statistical measure separates the top half of this set of data from the bottom half?

[A] median                      [B] mode  
[C] mean                        [D] average

2. Cole's Ice Cream Stand serves sixteen different flavors of ice cream, three types of syrup, and seven types of sprinkles. If an ice cream sundae consists of one flavor of ice cream, one type of syrup, and one type of sprinkles, how many different ice cream sundaes can Cole serve?

[A] 336    [B] 26    [C] 10,836    [D] 3

3. The value of  $\frac{7!}{3!}$  is

[A] 24    [B] 4    [C] 7    [D] 840

4. The equation  $*(\Delta + \diamond) = * \Delta + * \diamond$  is an example of the

[A] associative law    [B] commutative law  
[C] transitive law    [D] distributive law

5. The statement " $x$  is divisible by 5 or  $x$  is divisible by 4" is *false* when  $x$  equals

[A] 27    [B] 10    [C] 20    [D] 16

6. As shown in the accompanying diagram, the star in position 1 on a computer screen transforms to the star in position 2.

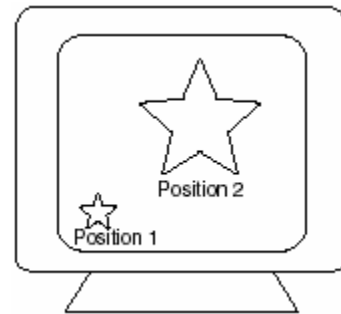

This transformation is best described as a

[A] rotation                      [B] dilation  
[C] line reflection              [D] translation

7. A stop sign in the shape of a regular octagon is resting on a brick wall, as shown in the accompanying diagram.

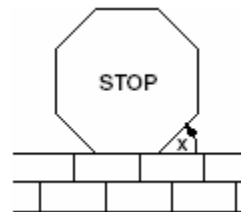

What is the measure of angle  $x$ ?

[A]  $135^\circ$     [B]  $45^\circ$     [C]  $60^\circ$     [D]  $120^\circ$

8. The height of a golf ball hit into the air is modeled by the equation  $h = -16t^2 + 48t$ , where  $h$  represents the height, in feet, and  $t$  represents the number of seconds that have passed since the ball was hit. What is the height of the ball after 2 seconds?

[A] 32 ft    [B] 64 ft    [C] 16 ft    [D] 80 ft

9. The sum of Scott's age and Greg's age is 33 years. If Greg's age is represented by  $g$ , Scott's age is represented by

[A]  $33g$                       [B]  $g + 33$   
[C]  $g - 33$                     [D]  $33 - g$

10. The accompanying diagram shows two parallel streets, Main Street and Brooks Road, intersected by Jay Street. The obtuse angle that Jay Street forms with Brooks Road is three times the measure of the acute angle that Jay Street forms with Main Street.

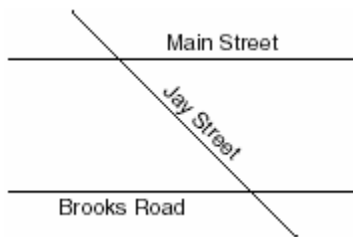

What is the measure of the acute angle formed by Jay Street and Main Street?

[A]  $90^\circ$     [B]  $60^\circ$     [C]  $135^\circ$     [D]  $45^\circ$

11. The expression  $0.62 \times 10^3$  is equivalent to

[A]  $6.2 \times 10^2$                       [B] 0.062  
[C]  $6.2 \times 10^4$                     [D] 62,000

12. Which equation represents the locus of all points 5 units below the  $x$ -axis?

[A]  $y = 5$                               [B]  $x = -5$   
[C]  $y = -5$                             [D]  $x = 5$

13. Which ordered pair is not in the solution set of  $y > 2x + 1$ ?

[A] (2,5)    [B] (3,8)    [C] (1,4)    [D] (1,6)

14. What is the identity element for  $\clubsuit$  in the accompanying table?

$\clubsuit$	$r$	$s$	$t$	$u$
$r$	$t$	$r$	$u$	$s$
$s$	$r$	$s$	$t$	$u$
$t$	$u$	$t$	$s$	$r$
$u$	$s$	$u$	$r$	$t$

[A]  $t$             [B]  $u$             [C]  $r$             [D]  $s$

15. A line segment on the coordinate plane has endpoints (2,4) and (4, $y$ ). The midpoint of the segment is point (3,7). What is the value of  $y$ ?

[A] 5            [B] 11            [C] -2            [D] 10

16. Which numbers are arranged from smallest to largest?

[A] 3.14,  $\frac{22}{7}$ ,  $\pi$ ,  $\sqrt{9.1}$

[B]  $\sqrt{9.1}$ ,  $\pi$ , 3.14,  $\frac{22}{7}$

[C]  $\sqrt{9.1}$ , 3.14,  $\frac{22}{7}$ ,  $\pi$

[D]  $\sqrt{9.1}$ , 3.14,  $\pi$ ,  $\frac{22}{7}$

17. In a certain quadrilateral, two opposite sides are parallel, and the other two opposite sides are *not* congruent. This quadrilateral could be a

[A] trapezoid                      [B] rhombus

[C] parallelogram                [D] square

18. A bicyclist leaves Bay Shore traveling at an average speed of 12 miles per hour. Three hours later, a car leaves Bay Shore, on the same route, traveling at an average speed of 30 miles per hour. How many hours after the car leaves Bay Shore will the car catch up to the cyclist?

- [A] 4      [B] 5      [C] 8      [D] 2

19. Which letter demonstrates line symmetry but *not* point symmetry?

- [A] **N**      [B] **H**      [C] **S**      [D] **T**

20. Sara is building a triangular pen for her pet rabbit. If two of the sides measure 8 feet and 15 feet, the length of the third side could be

- [A] 13 ft    [B] 3 ft    [C] 23 ft    [D] 7 ft

21. What is the converse of the statement "If Alicia goes to Albany, then Ben goes to Buffalo"?

- [A] If Ben goes to Buffalo, then Alicia goes to Albany.  
[B] If Alicia does not go to Albany, then Ben does not go to Buffalo.  
[C] If Ben does not go to Buffalo, then Alicia does not go to Albany.  
[D] Alicia goes to Albany if and only if Ben goes to Buffalo.

22. What is the value of  $2^{-3}$ ?

- [A] -8      [B]  $\frac{1}{6}$       [C] -6      [D]  $\frac{1}{8}$

23. Which is an irrational number?

- [A]  $\pi$       [B]  $\frac{3}{8}$       [C]  $0.\bar{3}$       [D]  $\sqrt{49}$

24. What is the sum of  $5\sqrt{7}$  and  $3\sqrt{28}$ ?

- [A]  $11\sqrt{7}$       [B]  $8\sqrt{35}$   
[C]  $60\sqrt{7}$       [D]  $9\sqrt{7}$

25. The solution set for the equation  $x^2 - 5x = 6$  is

- [A] {2,-3}      [B] {-1,6}  
[C] {1,-6}      [D] {-2,3}

26. The expression  $\frac{5x^6y^2}{x^8y}$  is equivalent to

- [A]  $\frac{5y^3}{x^{14}}$       [B]  $5x^{14}y^3$   
[C]  $5x^2y$       [D]  $\frac{5y}{x^2}$

27. The expression  ${}_9C_2$  is equivalent to

- [A]  ${}_9P_7$     [B]  ${}_9P_2$     [C]  ${}_9C_7$     [D]  $\frac{9!}{2!}$

28. The graph of the equation  $x^2 + y^2 = 4$  can be described as a

- [A] circle with its center at the origin and a radius of 2
- [B] circle with its center at the origin and a radius of 4
- [C] parabola with its vertex at (0,2)
- [D] line passing through points (0,2) and (2,0)

29. When solved graphically, which system of equations will have exactly one point of intersection?

- [A]  $y = \frac{3}{5}x + 12$   
 $y = 0.6x - 19$
- [B]  $y = -x - 20$   
 $y = x + 17$
- [C]  $y = -x + 15$   
 $y = -x + 25$
- [D]  $y = 0.5x + 30$   
 $y = 0.5x - 30$

30. If  $\frac{x}{4} - \frac{a}{b} = 0$ ,  $b \neq 0$ , then  $x$  is equal to

- [A]  $-\frac{4a}{b}$
- [B]  $-\frac{a}{4b}$
- [C]  $\frac{a}{4b}$
- [D]  $\frac{4a}{b}$

31. The accompanying diagram shows a kite that has been secured to a stake in the ground with a 20-foot string. The kite is located 12 feet from the ground, directly over point X. What is the distance, in feet, between the stake and point X?



32. There are 30 students on a school bus. Of these students, 24 either play in the school band or sing in the chorus. Six of the students play in the school band but do not sing in the chorus. Fourteen of the students sing in the chorus and also play in the school band. How many students on the school bus sing in the chorus but do not play in the band?

33. Factor completely:  $5n^2 - 80$

34. Nine hundred students were asked whether they thought their school should have a dress code. A circle graph was constructed to show the results. The central angles for two of the three sectors are shown in the accompanying diagram. What is the number of students who felt that the school should have no dress code?

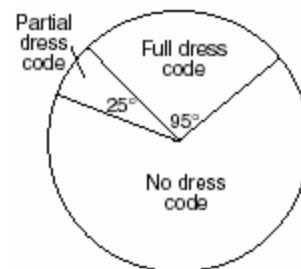

35. Seth bought a used car that had been driven 20,000 miles. After he owned the car for 2 years, the total mileage of the car was 49,400. Find the average number of miles he drove *each month* during those 2 years.

36. A tree casts a shadow that is 20 feet long. The angle of elevation from the end of the shadow to the top of the tree is  $66^\circ$ . Determine the height of the tree, to the *nearest foot*.

37. In the accompanying diagram, the perimeter of  $\triangle MNO$  is equal to the perimeter of square  $ABCD$ . If the sides of the triangle are represented by  $4x + 4$ ,  $5x - 3$ , and 17, and one side of the square is represented by  $3x$ , find the length of a side of the square.

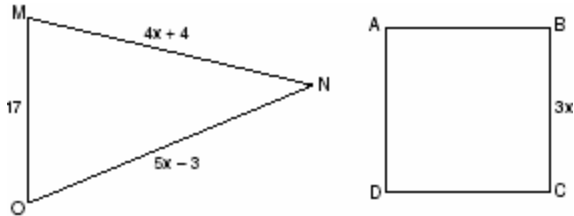

38. Solve the following system of equations:

$$y = x^2 + 4x + 1$$

$$y = 5x + 3$$

[The use of the grid is optional.]

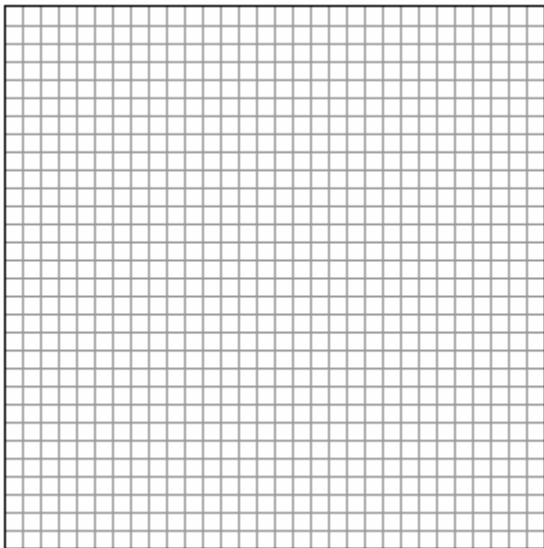

39. Mr. Petri has a rectangular plot of land with length = 20 feet and width = 10 feet. He wants to design a flower garden in the shape of a circle with two semicircles at each end of the center circle, as shown in the accompanying diagram. He will fill in the shaded area with wood chips. If one bag of wood chips covers 5 square feet, how many bags must he buy?

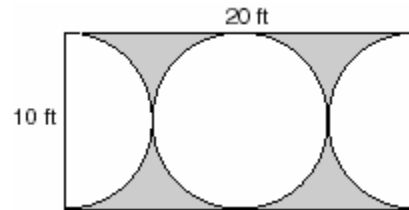



1. What is the value of  $x$  in the equation  $5(2x - 7) = 15x - 10$ ?

[A] 1      [B] -9      [C] 0.6      [D] -5

2. Ms. Brewer's art class is drawing reflected images. She wants her students to draw images reflected in a line. Which diagram represents a correctly drawn image?

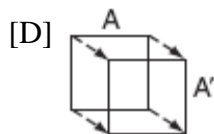
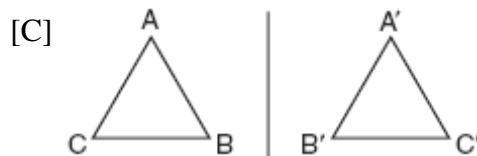
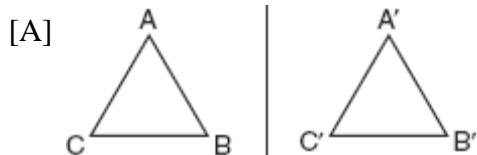

3. The lengths of the sides of home plate in a baseball field are represented by the expressions in the accompanying figure.

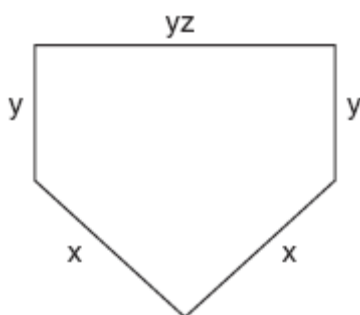

Which expression represents the perimeter of the figure?

[A]  $2x + 3yz$       [B]  $5xyz$   
[C]  $x^2 + y^3z$       [D]  $2x + 2y + yz$

4. Which expression represents "5 less than the product of 7 and  $x$ "?

[A]  $7(x - 5)$       [B]  $7 + x - 5$   
[C]  $7x - 5$       [D]  $5 - 7x$

5. What is the  $y$ -intercept of the graph of the line whose equation is  $y = -\frac{2}{5}x + 4$ ?

[A]  $-\frac{2}{5}$       [B] 4      [C] 0      [D]  $-\frac{5}{2}$

6. Which is an equation of the line of symmetry for the parabola in the accompanying diagram?

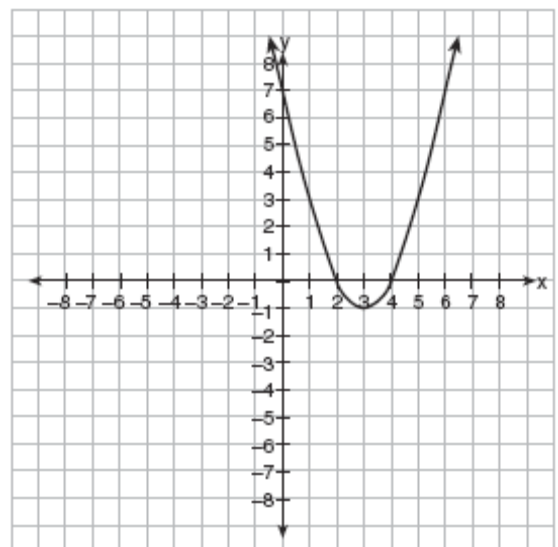

[A]  $x = 3$       [B]  $y = 3$   
[C]  $x = 4$       [D]  $x = 2$

7. For which value of  $x$  will the fraction  $\frac{3}{2x + 4}$  be undefined?

[A] -4      [B] 2      [C] 0      [D] -2

8. The equation  $A = \frac{1}{2}(12)(3+7)$  is used to find the area of a trapezoid. Which calculation would *not* result in the correct area?

- [A]  $6(3+7)$                       [B]  $0.5(12)(10)$   
 [C]  $\frac{12}{2} \times \frac{10}{2}$                       [D]  $\frac{12(3+7)}{2}$

9. The size of a certain type of molecule is 0.00009078 inch. If this number is expressed as  $9.078 \times 10^n$ , what is the value of  $n$ ?

- [A] -8      [B] -5      [C] 5      [D] 8

10. In order to be admitted for a certain ride at an amusement park, a child must be greater than or equal to 36 inches tall and less than 48 inches tall. Which graph represents these conditions?

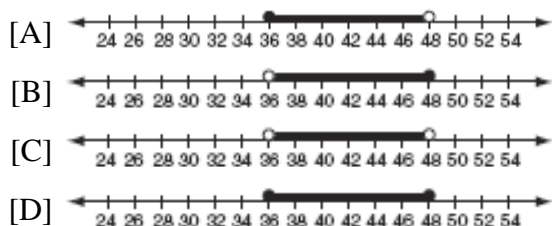

11. The accompanying circle graph shows how Shannon earned \$600 during her summer vacation.



What is the measure of the central angle of the section labeled "Chores"?

- [A]  $60^\circ$     [B]  $30^\circ$     [C]  $90^\circ$     [D]  $120^\circ$

12. Robin has 8 blouses, 6 skirts, and 5 scarves. Which expression can be used to calculate the number of different outfits she can choose, if an outfit consists of a blouse, a skirt, and a scarf?

- [A]  $8 \cdot 6 \cdot 5$                       [B]  $8!6!5!$   
 [C]  $8+6+5$                       [D]  ${}_{19}C_3$

13. In the accompanying diagram of  $\triangle ABC$ ,  $\overline{AB}$  is extended through  $D$ ,  $m\angle CBD = 30$ , and  $\overline{AB} \cong \overline{BC}$ .

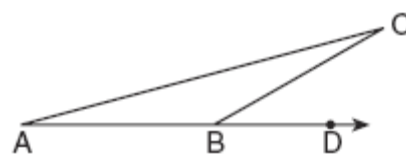

What is the measure of  $\angle A$ ?

- [A]  $30^\circ$     [B]  $75^\circ$     [C]  $15^\circ$     [D]  $150^\circ$

14. The image of point  $(-2,3)$  under translation  $T$  is  $(3,-1)$ . What is the image of point  $(4,2)$  under the same translation?

- [A]  $(-1,6)$                       [B]  $(9,-2)$   
 [C]  $(0,7)$                       [D]  $(5,4)$

15. A builder is building a rectangular deck with dimensions of 16 feet by 30 feet. To ensure that the sides form  $90^\circ$  angles, what should each diagonal measure?

- [A] 16 ft                      [B] 30 ft  
 [C] 46 ft                      [D] 34 ft

16. Which statement is the inverse of "If the waves are small, I do not go surfing"?

- [A] If the waves are not small, I do not go surfing.  
 [B] If I go surfing, the waves are not small.  
 [C] If I do not go surfing, the waves are small.  
 [D] If the waves are not small, I go surfing.

17. A dog is tied with a rope to a stake in the ground. The length of the rope is 5 yards. What is the area, in square yards, in which the dog can roam?

[A] 20 [B] 25 [C]  $25\pi$  [D]  $10\pi$

18. Melissa's test scores are 75, 83, and 75. Which statement is true about this set of data?

[A] mean = median  
[B] mode = median  
[C] mean < mode [D] mode < median

19. When  $3a^2 - 7a + 6$  is subtracted from  $4a^2 - 3a + 4$ , the result is

[A]  $a^2 + 4a - 2$  [B]  $a^2 - 10a - 2$   
[C]  $-a^2 - 4a + 2$  [D]  $7a^2 - 10a + 10$

20. In the equation  $A = p + prt$ ,  $t$  is equivalent to

[A]  $\frac{A-p}{pr}$  [B]  $\frac{A-pr}{p}$   
[C]  $\frac{A}{p} - pr$  [D]  $\frac{A}{pr} - p$

21. The accompanying Venn diagram shows the results of a survey asking 100 people if they get news by reading newspapers or by watching television.

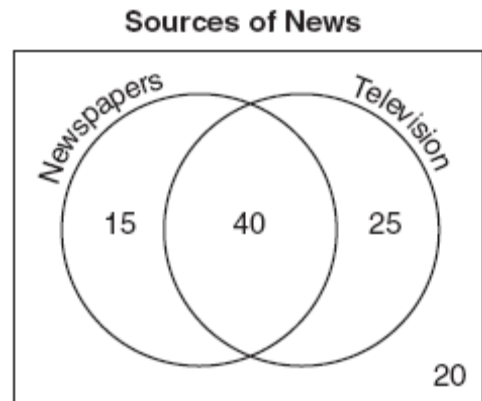

What is the probability that a person selected at random from this survey does *not* claim television as a source of getting the news?

[A]  $\frac{35}{100}$  [B]  $\frac{55}{100}$   
[C]  $\frac{15}{100}$  [D]  $\frac{75}{100}$

22. The expression  $\frac{6\sqrt{20}}{3\sqrt{5}}$  is equivalent to

[A]  $2\sqrt{15}$  [B] 4 [C]  $3\sqrt{15}$  [D] 8

23. In the accompanying diagram, point  $P$  lies 3 centimeters from line  $\ell$ .

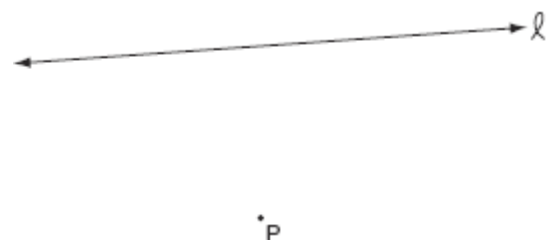

How many points are both 2 centimeters from line  $\ell$  and 1 centimeter from point  $P$ ?

[A] 1 [B] 0 [C] 4 [D] 2

24. The ratio of two supplementary angles is 3:6. What is the measure of the *smaller* angle?  
[A]  $10^\circ$  [B]  $30^\circ$  [C]  $60^\circ$  [D]  $20^\circ$
25. Which point is on the circle whose equation is  $x^2 + y^2 = 289$ ?  
[A] (-1,-16) [B] (8,-15)  
[C] (-12,12) [D] (7,-10)
26. The Edison Lightbulb Company tests 5% of their daily production of lightbulbs. If 500 bulbs were tested on Tuesday, what was the total number of bulbs produced that day?  
[A] 25 [B] 10,000  
[C] 1,000 [D] 100,000
27. Which statement is expressed as a biconditional?  
[A] Two angles are congruent if and only if they have the same measure.  
[B] If two angles are both right angles, then they are congruent.  
[C] Two angles are congruent if they have the same measure.  
[D] If two angles are congruent, then they are both right angles.
28. A committee of five members is to be randomly selected from a group of nine freshmen and seven sophomores. Which expression represents the number of different committees of three freshmen and two sophomores that can be chosen?  
[A]  ${}_9C_3 + {}_7C_2$  [B]  ${}_{16}C_3 \cdot {}_{16}C_2$   
[C]  ${}_9C_3 \cdot {}_7C_2$  [D]  ${}_9P_3 \cdot {}_7P_2$

29. Which inequality is represented by the accompanying graph?

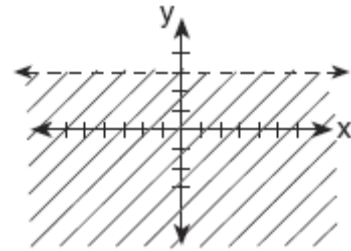

- [A]  $y > 3$  [B]  $y \leq 3$   
[C]  $y \geq 3$  [D]  $y < 3$
30. Which equation illustrates the multiplicative inverse property?  
[A]  $1 \cdot x = x$  [B]  $1 \cdot 0 = 0$   
[C]  $x \cdot \frac{1}{x} = 1$  [D]  $-1 \cdot x = -x$
31. Simplify:  $\frac{x^2 + 6x + 5}{x^2 - 25}$
32. Write an irrational number and explain why it is irrational.

33. In a circle whose center is (2,3), one endpoint of a diameter is (-1,5). Find the coordinates of the other endpoint of that diameter. [The use of the accompanying grid is optional.]

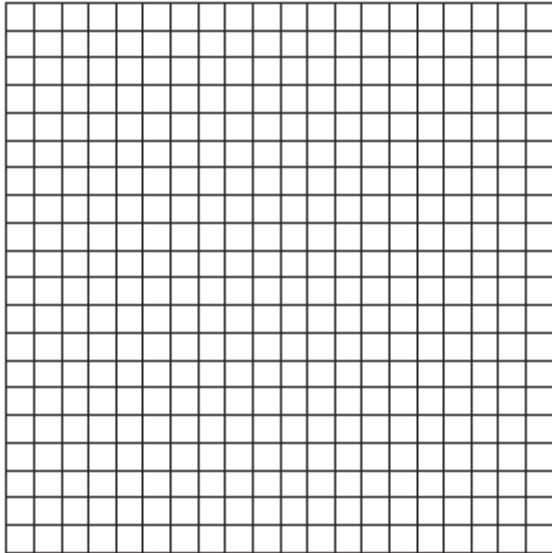

34. The accompanying diagram shows a square dartboard. The side of the dartboard measures 30 inches. The square shaded region at the center has a side that measures 10 inches. If darts thrown at the board are equally likely to land anywhere on the board, what is the theoretical probability that a dart does *not* land in the shaded region?

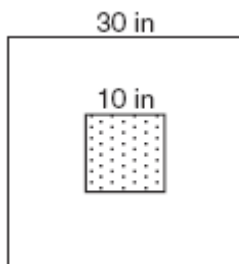

35. A candy store sells 8-pound bags of mixed hazelnuts and cashews. If  $c$  pounds of cashews are in a bag, the price  $p$  of the bag can be found using the formula  $p = 2.59c + 1.72(8 - c)$ . If one bag is priced at \$18.11, how many pounds of cashews does it contain?

36. Solve for  $x$ :  $\frac{1}{16}x + \frac{1}{4} = \frac{1}{2}$

37. Solve for  $x$ :  $x^2 + 2x - 24 = 0$

38. As shown in the accompanying diagram, a ladder is leaning against a vertical wall, making an angle of  $70^\circ$  with the ground and reaching a height of 10.39 feet on the wall. Find, to the *nearest foot*, the length of the ladder. Find, to the *nearest foot*, the distance from the base of the ladder to the wall.

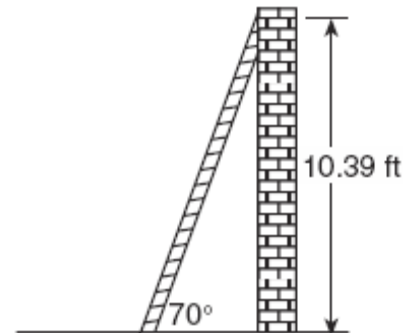

39. In the accompanying diagram,  $\overleftrightarrow{CD} \parallel \overleftrightarrow{EF}$ ,  $\overleftrightarrow{AB}$  is a transversal,  $m\angle DGH = 2x$ , and  $m\angle FHB = 5x - 51$ . Find the measure, in degrees, of  $\angle BHE$ .

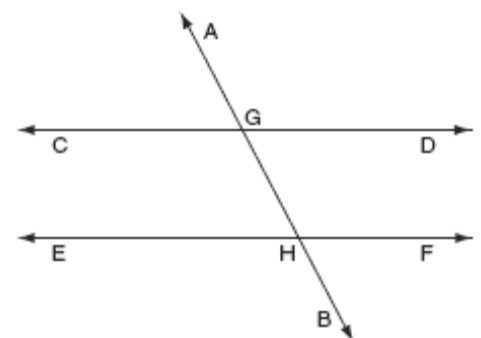

35. A candy store sells 8-pound bags of mixed hazelnuts and cashews. If  $c$  pounds of cashews are in a bag, the price  $p$  of the bag can be found using the formula  $p = 2.59c + 1.72(8 - c)$ . If one bag is priced at \$18.11, how many pounds of cashews does it contain?

1. In the accompanying diagram, line  $a$  intersects line  $b$ .



What is the value of  $x$ ?

- [A] -10 [B] 90 [C] 5 [D] 10

2. What is the value of  $x$  in the equation  $13x - 2(x + 4) = 8x + 1$ ?

- [A] 2 [B] 1 [C] 4 [D] 3

3. One function of a movie projector is to enlarge the image on the film. This procedure is an example of a

- [A] translation [B] line of symmetry  
[C] dilation [D] line reflection

4. What is the product of  $\frac{1}{3}x^2y$  and  $\frac{1}{6}xy^3$ ?

- [A]  $\frac{1}{18}x^3y^4$  [B]  $\frac{1}{2}x^2y^3$   
[C]  $\frac{1}{9}x^3y^4$  [D]  $\frac{1}{18}x^2y^3$

5. What is the value of  $\frac{8!}{4!}$ ?

- [A] 4! [B] 1,680 [C] 2 [D] 2!

6. In the accompanying diagram,  $\overline{AB} \parallel \overline{CD}$ . From point  $E$  on  $\overline{AB}$ , transversals  $\overline{EF}$  and  $\overline{EG}$  are drawn, intersecting  $\overline{CD}$  at  $H$  and  $I$ , respectively.

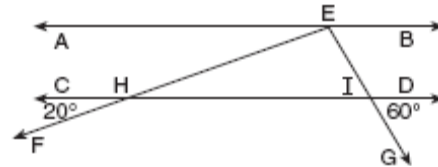

If  $m\angle CHF = 20$  and  $m\angle DIG = 60$ , what is  $m\angle HEI$ ?

- [A] 80 [B] 100 [C] 60 [D] 120

7. Leo purchased five shirts, three pairs of pants, and four pairs of shoes. Which expression represents how many different outfits consisting of one shirt, one pair of pants, and one pair of shoes Leo can make?

- [A]  ${}_{12}C_3$  [B]  ${}_{12}P_3$   
[C]  $5 + 3 + 4$  [D]  $5 \cdot 3 \cdot 4$

8. What is the length of one side of the square whose perimeter has the same numerical value as its area?

- [A] 5 [B] 6 [C] 4 [D] 3

9. Which list is in order from smallest value to largest value?

- [A]  $3.1, \pi, \frac{22}{7}, \sqrt{10}$  [B]  $\pi, \frac{22}{7}, 3.1, \sqrt{10}$   
[C]  $3.1, \frac{22}{7}, \pi, \sqrt{10}$  [D]  $\sqrt{10}, \frac{22}{7}, \pi, 3.1$

10. The accompanying box-and-whisker plot represents the scores earned on a science test.

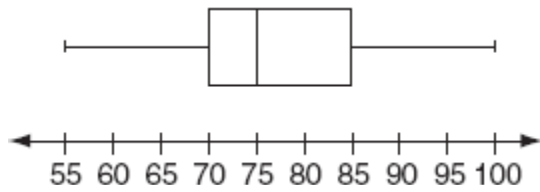

What is the median score?

- [A] 77    [B] 75    [C] 85    [D] 70
11. The second side of a triangle is two more than the first side, and the third side is three less than the first side. Which expression represents the perimeter of the triangle?

- [A]  $x^2 - x - 6$     [B]  $3x - 1$   
[C]  $2x - 1$     [D]  $x + 5$

12. What is the value of  $x$  in the equation

$$\frac{x}{2x+1} = \frac{4}{3}?$$

- [A]  $-5$     [B]  $-\frac{4}{5}$     [C]  $-\frac{5}{4}$     [D]  $-\frac{1}{5}$

13. Which statement describes the graph of  $x = 4$ ?

- [A] It is parallel to the  $x$ -axis.  
[B] It is parallel to the  $y$ -axis.  
[C] It passes through the point  $(0, 4)$ .  
[D] It has a slope of 4.

14. Given the statement: "If  $x$  is a rational number, then  $\sqrt{x}$  is irrational." Which value of  $x$  makes the statement *false*?

- [A] 3    [B] 2    [C]  $\frac{3}{2}$     [D] 4

15. The accompanying diagram shows the roof of a house that is in the shape of an isosceles triangle. The vertex angle formed at the peak of the roof is  $84^\circ$ .

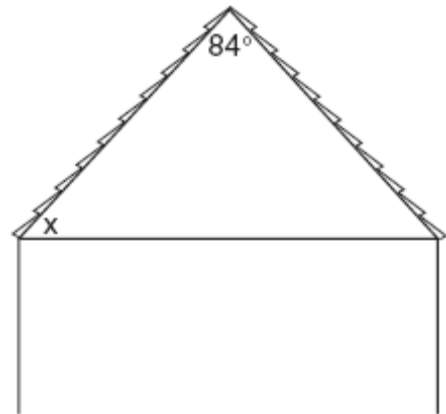

What is the measure of  $x$ ?

- [A]  $96^\circ$     [B]  $138^\circ$     [C]  $48^\circ$     [D]  $84^\circ$

16. Which graph best represents the solution set for the inequality  $x > \sqrt{2}$ ?

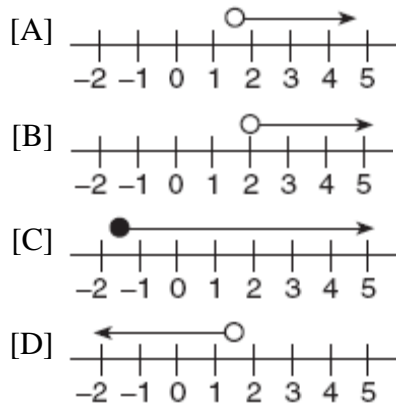

17. The formula for the volume of a right circular cylinder is  $V = \pi r^2 h$ . The value of  $h$  can be expressed as

[A]  $\frac{\pi r^2}{V}$                       [B]  $\frac{V}{\pi r^2}$

[C]  $\frac{V}{\pi} r^2$                       [D]  $V - \pi r^2$

18. If a line is horizontal, its slope is

- [A] negative                      [B] undefined
- [C] 0                                  [D] 1

19. Chantrice is pulling a wagon along a smooth, horizontal street. The path of the center of one of the wagon wheels is best described as

- [A] a circle
- [B] a line perpendicular to the road
- [C] a line parallel to the road
- [D] two parallel lines

20. Which coordinate point is in the solution set for the system of inequalities shown in the accompanying graph?

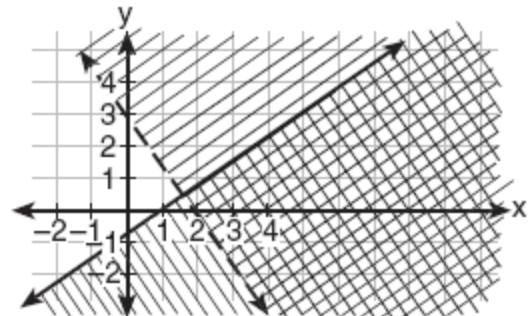

- [A] (2,2)                              [B] (0,1)
- [C] (1,-1)                            [D] (3,1)

21. The measures of two complementary angles are represented by  $(3x + 15)$  and  $(2x - 10)$ . What is the value of  $x$ ?

- [A] 19                      [B] 17                      [C] 35                      [D] 37

22. If  $x = 3$ , which statement is *false*?

- [A]  $x$  is odd and  $2x$  is even.
- [B]  $x$  is odd or  $x$  is even.
- [C]  $x$  is prime and  $x$  is odd.
- [D]  $x$  is not prime and  $x$  is odd.

23. Factored completely, the expression  $2y^2 + 12y - 54$  is equivalent to

- [A]  $2(y - 3)(y - 9)$                       [B]  $2(y + 9)(y - 3)$
- [C]  $(2y + 6)(y - 9)$                       [D]  $(y + 6)(2y - 9)$



24. Which statement best illustrates the additive identity property?

- [A]  $6 + (-6) = 0$       [B]  $6 + 2 = 2 + 6$   
[C]  $6(2) = 2(6)$       [D]  $6 + 0 = 6$

25. The expression  $\frac{5x}{6} + \frac{x}{4}$  is equivalent to

- [A]  $\frac{3x}{5}$     [B]  $\frac{5x^2}{10}$     [C]  $\frac{13x}{12}$     [D]  $\frac{5x}{24}$

26. In the accompanying diagram of parallelogram  $ABCD$ , diagonals  $\overline{AC}$  and  $\overline{BD}$  intersect at  $E$ ,  $BE = \frac{2}{3}x$ , and  $ED = x - 10$ .

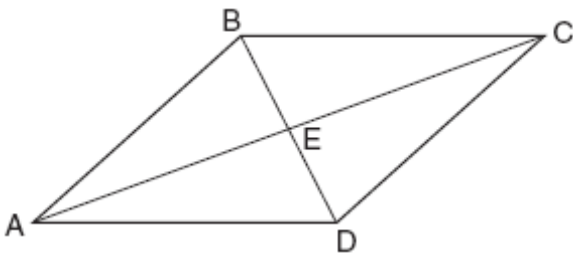

What is the value of  $x$ ?

- [A] 30    [B] -30    [C] -6    [D] 6

27. Expressed in simplest radical form, the product of  $\sqrt{6} \cdot \sqrt{15}$  is

- [A]  $3\sqrt{15}$       [B]  $9\sqrt{10}$   
[C]  $3\sqrt{10}$       [D]  $\sqrt{90}$

28. What is the sum of  $6 \times 10^3$  and  $3 \times 10^2$ ?

- [A]  $9 \times 10^6$       [B]  $6.3 \times 10^3$   
[C]  $9 \times 10^5$       [D]  $18 \times 10^5$

29. On the banks of a river, surveyors marked locations  $A$ ,  $B$ , and  $C$ . The measure of  $\angle ACB = 70^\circ$  and the measure of  $\angle ABC = 65^\circ$ .

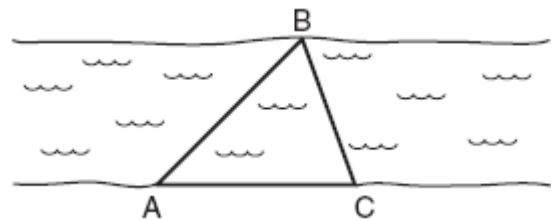

Which expression shows the relationship between the lengths of the sides of this triangle?

- [A]  $BC < AB < AC$     [B]  $AC < AB < BC$   
[C]  $AB < BC < AC$     [D]  $BC < AC < AB$

30. Which inequality represents the probability,  $x$ , of any event happening?

- [A]  $0 < x < 1$       [B]  $x \geq 0$   
[C]  $x < 1$       [D]  $0 \leq x \leq 1$

31. Determine the area, in square feet, of the *smallest* square that can contain a circle with a radius of 8 feet.

32. Five friends met for lunch, and they all shook hands. Each person shook the other person's right hand only once. What was the total number of handshakes?

33. Two hikers started at the same location. One traveled 2 miles east and then 1 mile north. The other traveled 1 mile west and then 3 miles south. At the end of their hikes, how many miles apart are the two hikers? [The use of the accompanying grid is optional.]

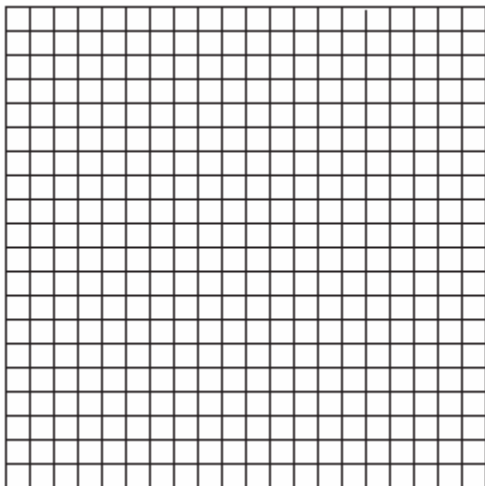

34. Solve for  $x$ :  $3.3 - x = 3(x - 1.7)$

35. On the accompanying square, draw all the lines of symmetry.



36. Tamara has two sisters. One of the sisters is 7 years older than Tamara. The other sister is 3 years younger than Tamara. The product of Tamara's sisters' ages is 24. How old is Tamara?

37. Sara's test scores in mathematics were 64, 80, 88, 78, 60, 92, 84, 76, 86, 78, 72, and 90. Determine the mean, the median, and the mode of Sara's test scores.

38. Sharu has \$2.35 in nickels and dimes. If he has a total of thirty-two coins, how many of *each* coin does he have?

39. A person measures the angle of depression from the top of a wall to a point on the ground. The point is located on level ground 62 feet from the base of the wall and the angle of depression is  $52^\circ$ . How high is the wall, to the *nearest tenth of a foot*?